



COMUNE DI REGGELLO

PROVINCIA DI FIRENZE

INDAGINI IDROLOGICHE E IDRAULICHE DI SUPPORTO AL PIANO OPERATIVO CON AGGIORNAMENTO DEL QUADRO CONOSCITIVO DEL PIANO STRUTTURALE

SEZIONI FLUVIALI
Allegato A.103

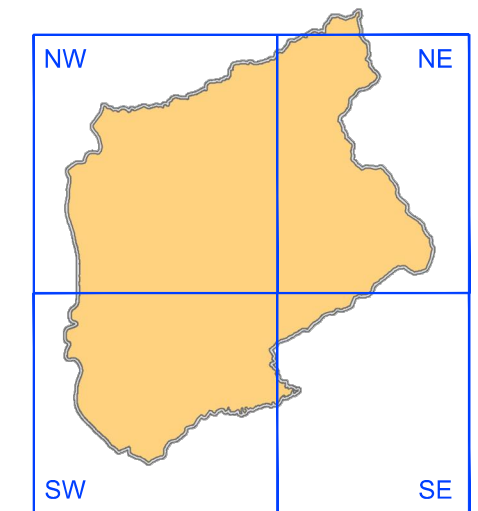

Professionista incaricato:
Ing. David Settesoldi

Emesso: marzo 2020 Aggiornamento: giugno 2020	Revisionato:	Adottato con	Approvato con:
--	--------------	--------------	----------------



VIA ANDREA DEL CASTAGNO, 8
50132 FIRENZE
Tel. e Fax 055.571393-575954
C.F. e P. IVA 02287880484



PHYSIS DIVISIONE WEST SYSTEMS
SEDE VIALE DONATO GIANNOTTI
50126 FIRENZE
Tel. 055.461429 Fax 055.6580564
P. IVA 01071300501

INDICE	
AFFLUENTE LECCIO - TEMPO DI RITORNO=30, 200 E 500 ANNI.....	2
FOSSO BORRACCINO - TEMPO DI RITORNO=30, 200 E 500 ANNI.....	8
FOSSO PODERINO - TEMPO DI RITORNO=30, 200 E 500 ANNI	13
FOSSO PODERE CAPPELLA - TEMPO DI RITORNO=30, 200 E 500 ANNI	22
BORRO COLMATE, TRATTO A MONTE DELLA CONFLUENZA CON IL DIVERSIVO - TEMPO DI RITORNO=30, 200 E 500 ANNI	32
BORRO COLMATE, TRATTO A VALLE DELLA CONFLUENZA CON IL DIVERSIVO - TEMPO DI RITORNO=30, 200 E 500 ANNI.....	43
DIVERSIVO BORRO COLMATE - TEMPO DI RITORNO=30, 200 E 500 ANNI.....	50
TORRENTE RESCO - TEMPO DI RITORNO=30, 200 E 500 ANNI.....	59

Sezioni fluviali
Affluente Leccio
Tempo di ritorno: 30, 200 e 500 anni

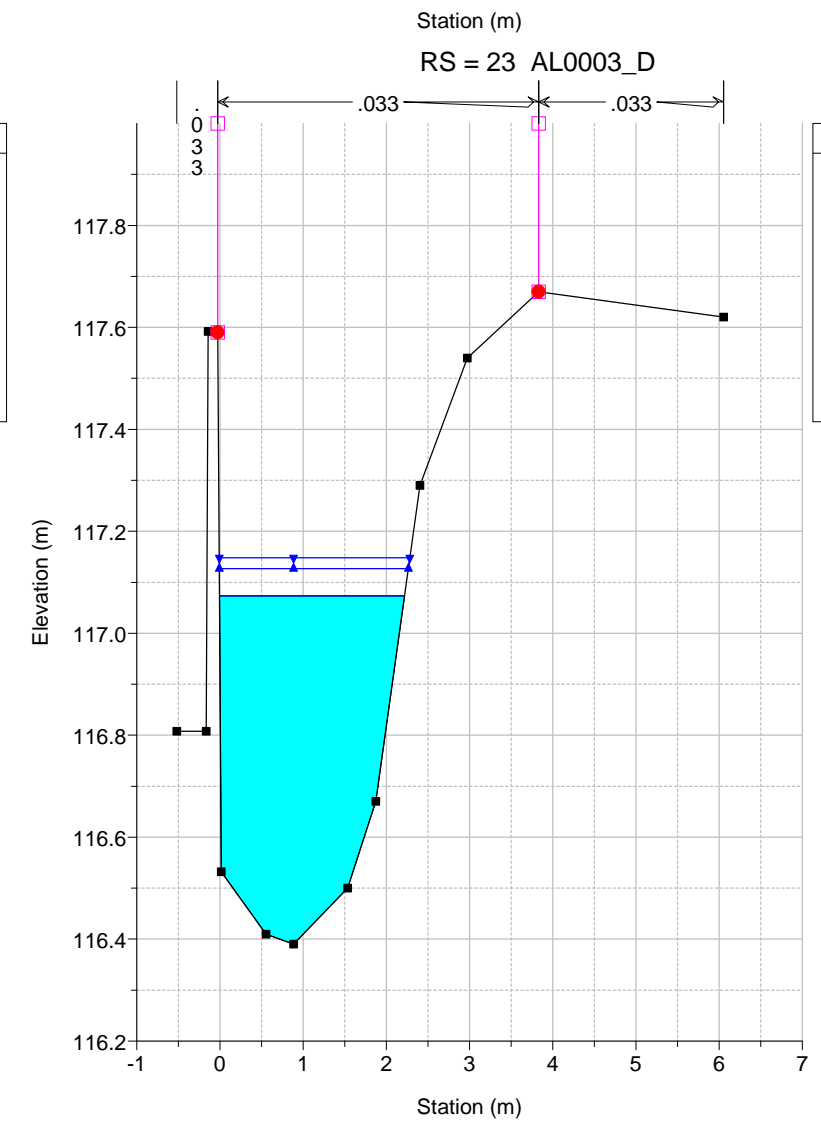
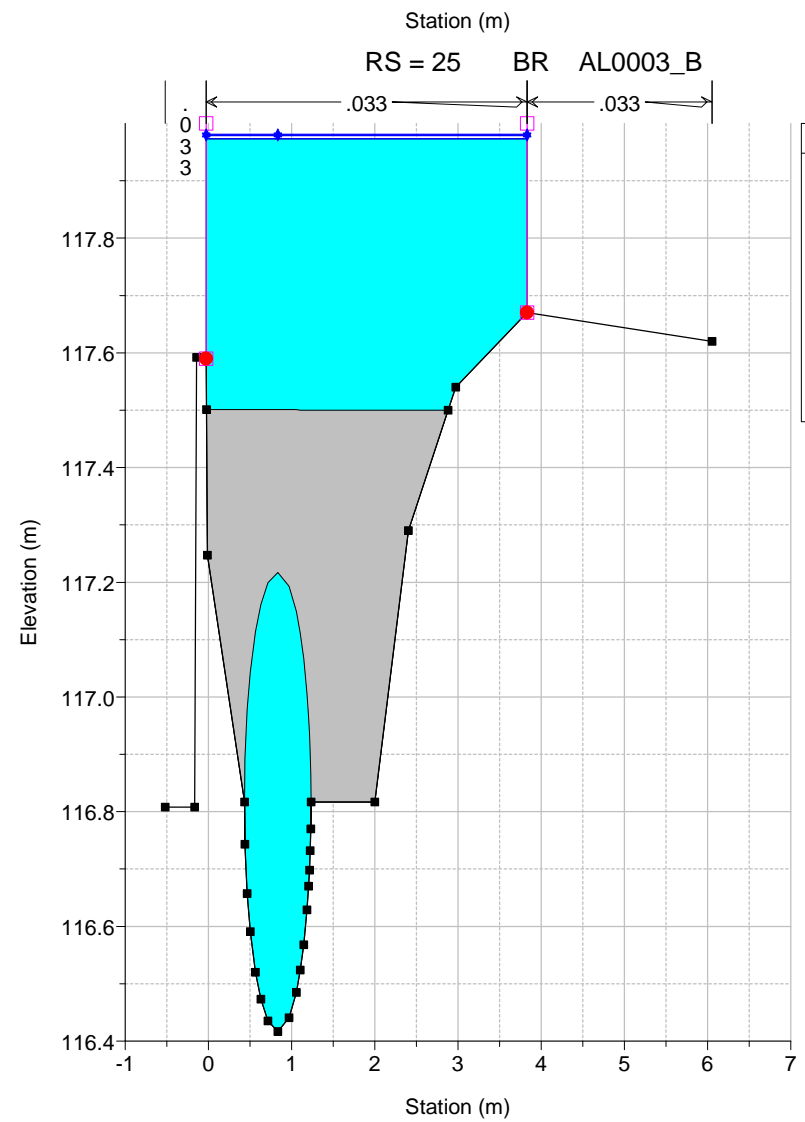
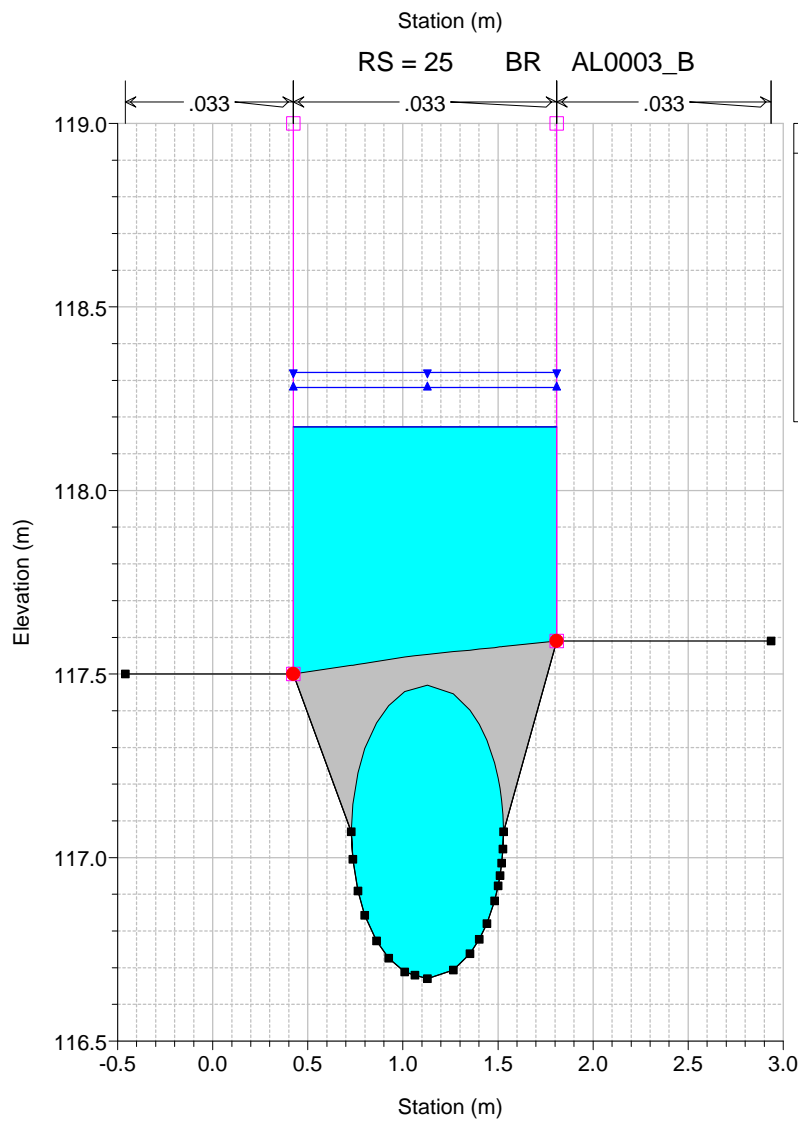
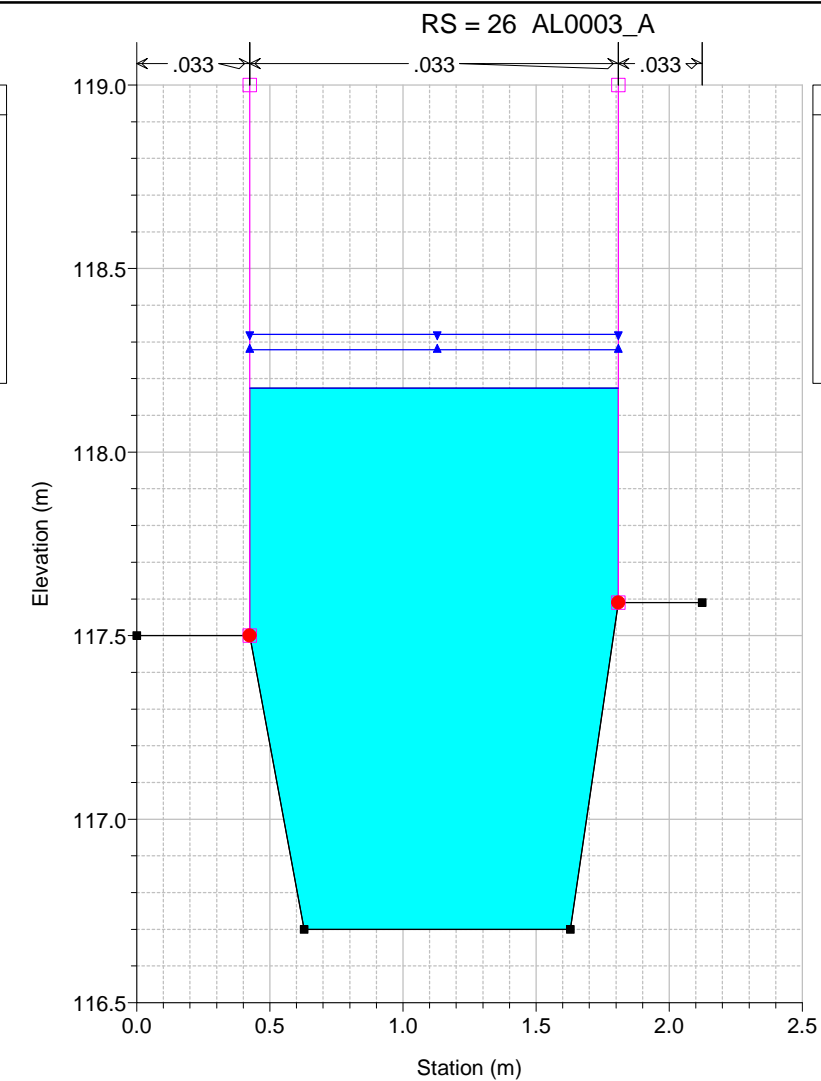
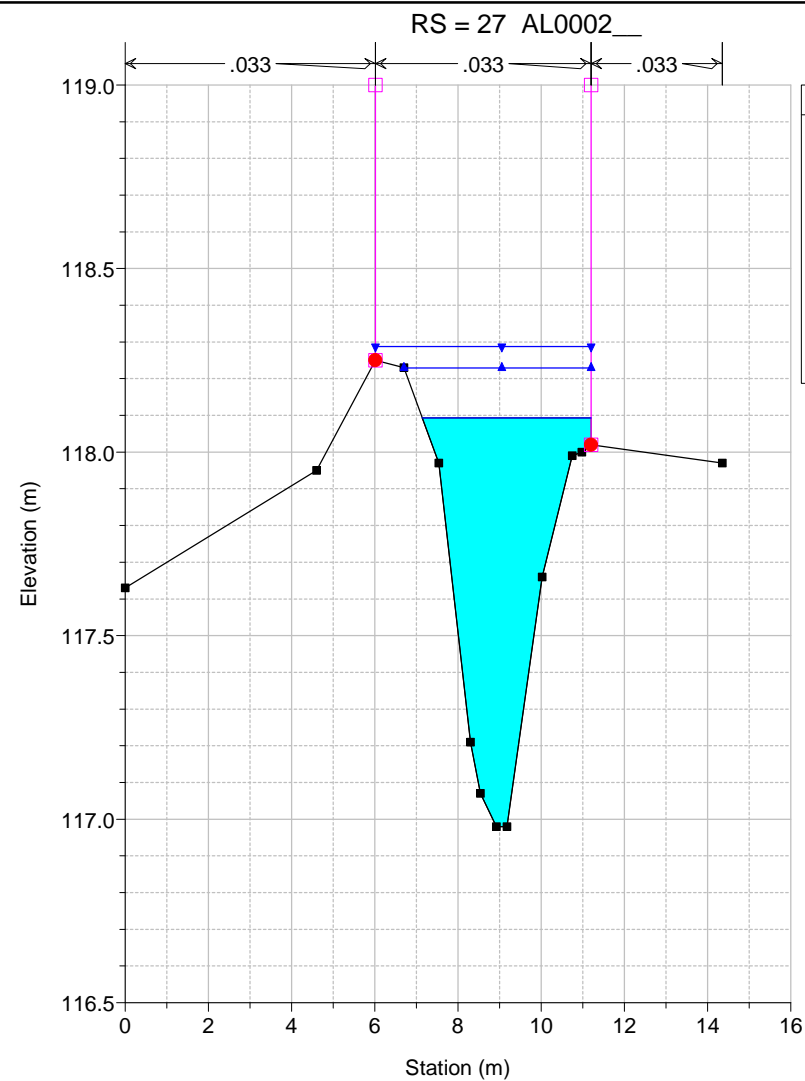
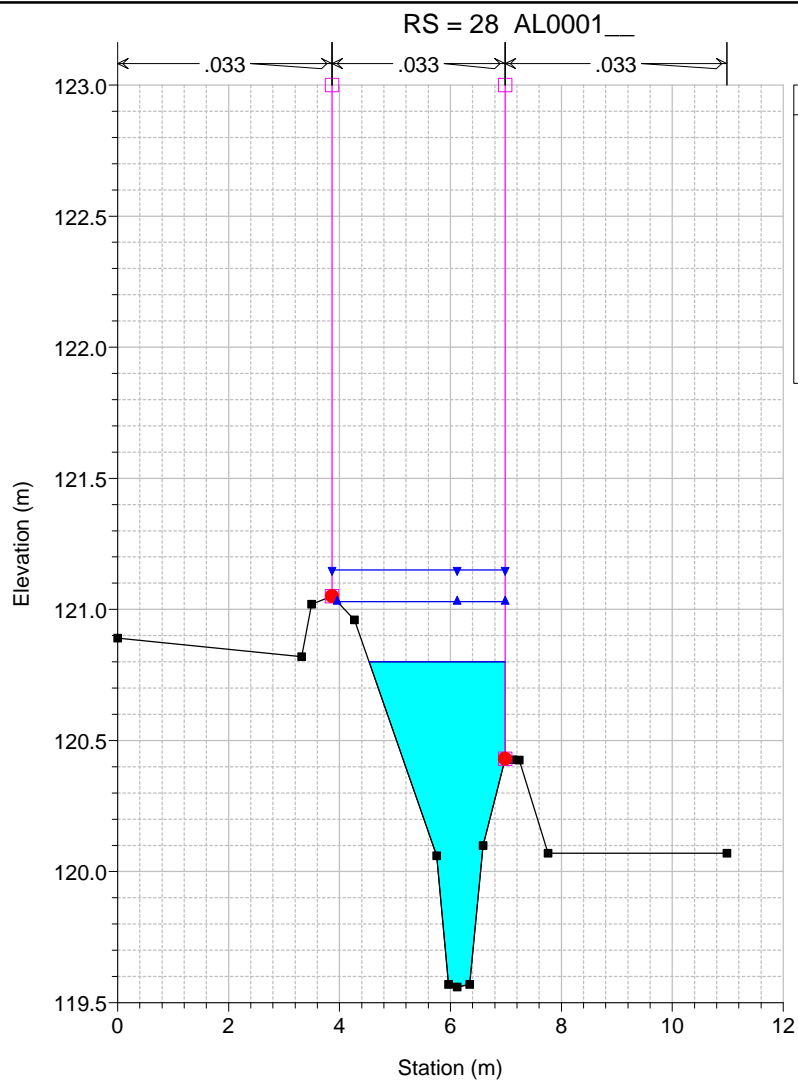

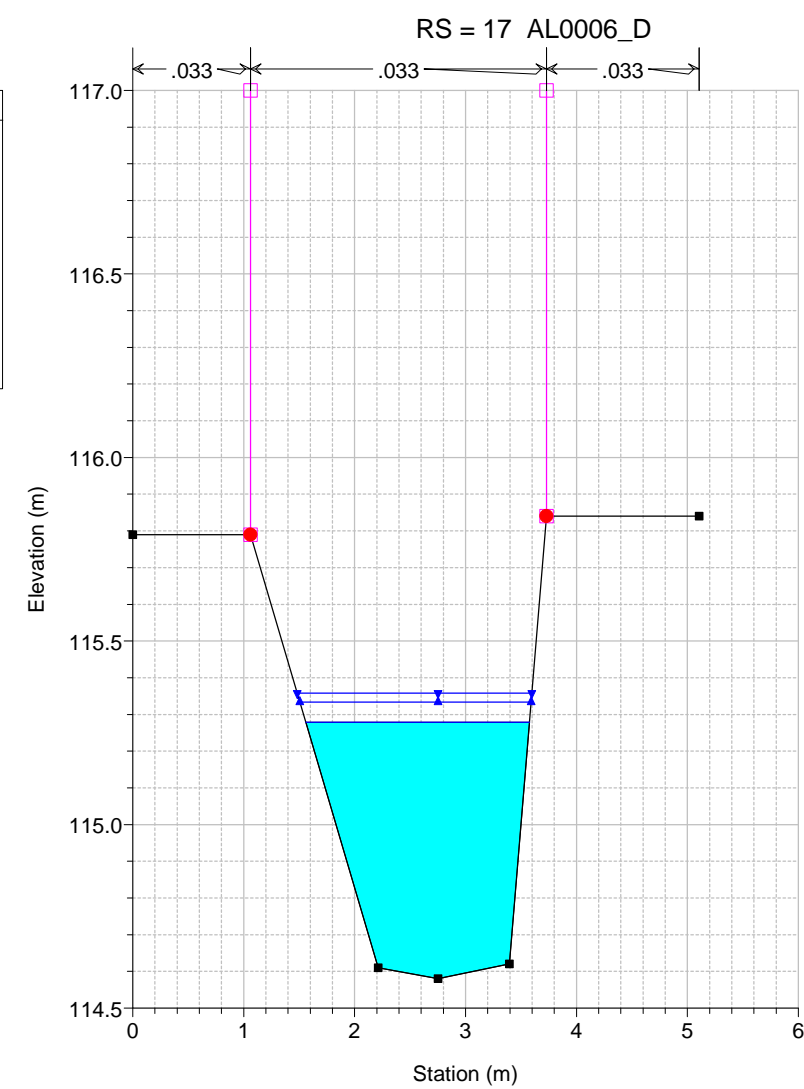
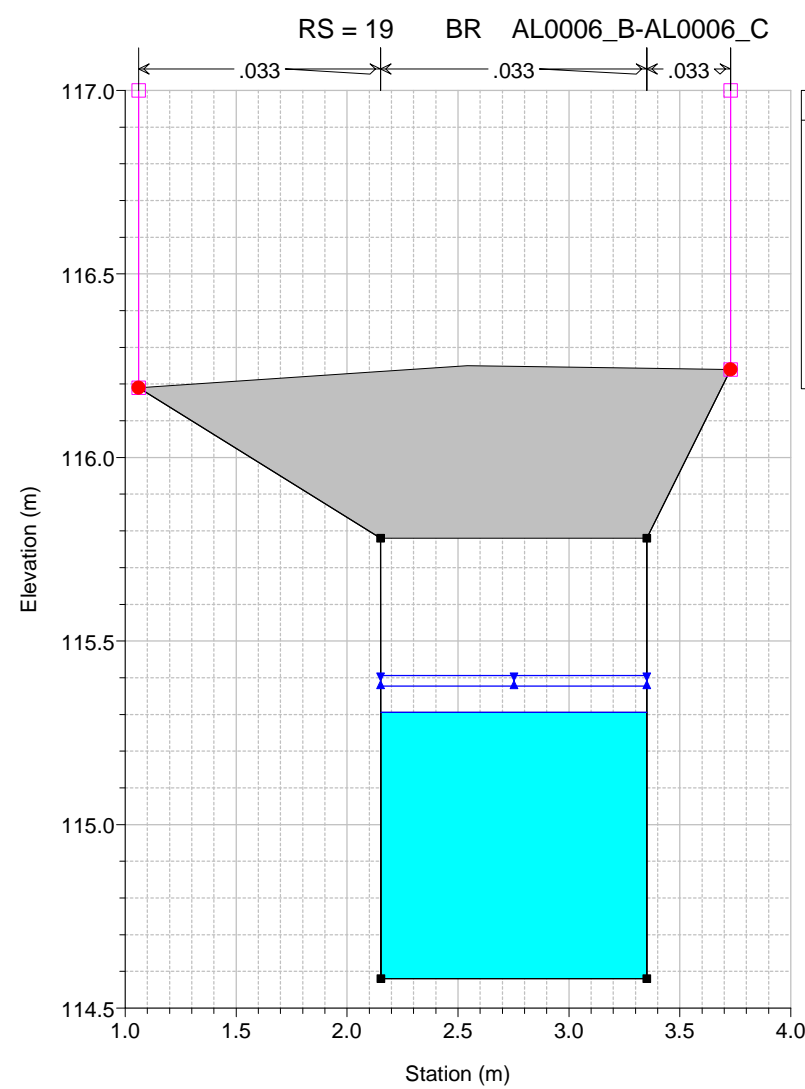
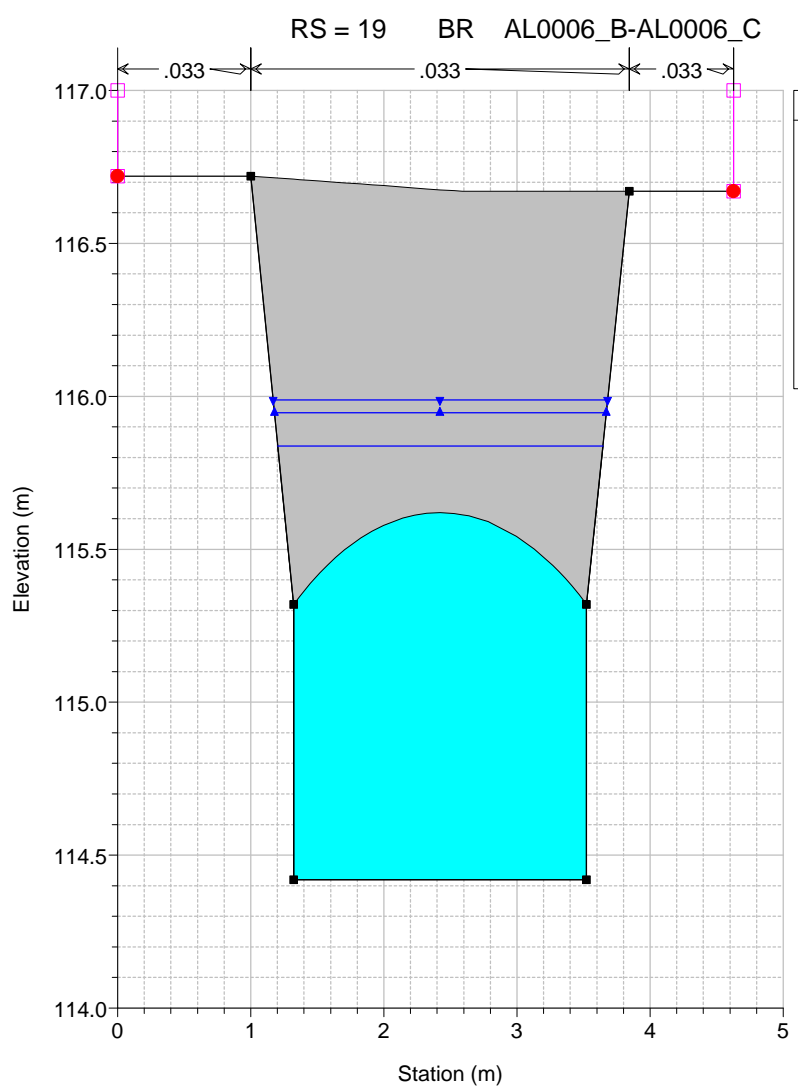
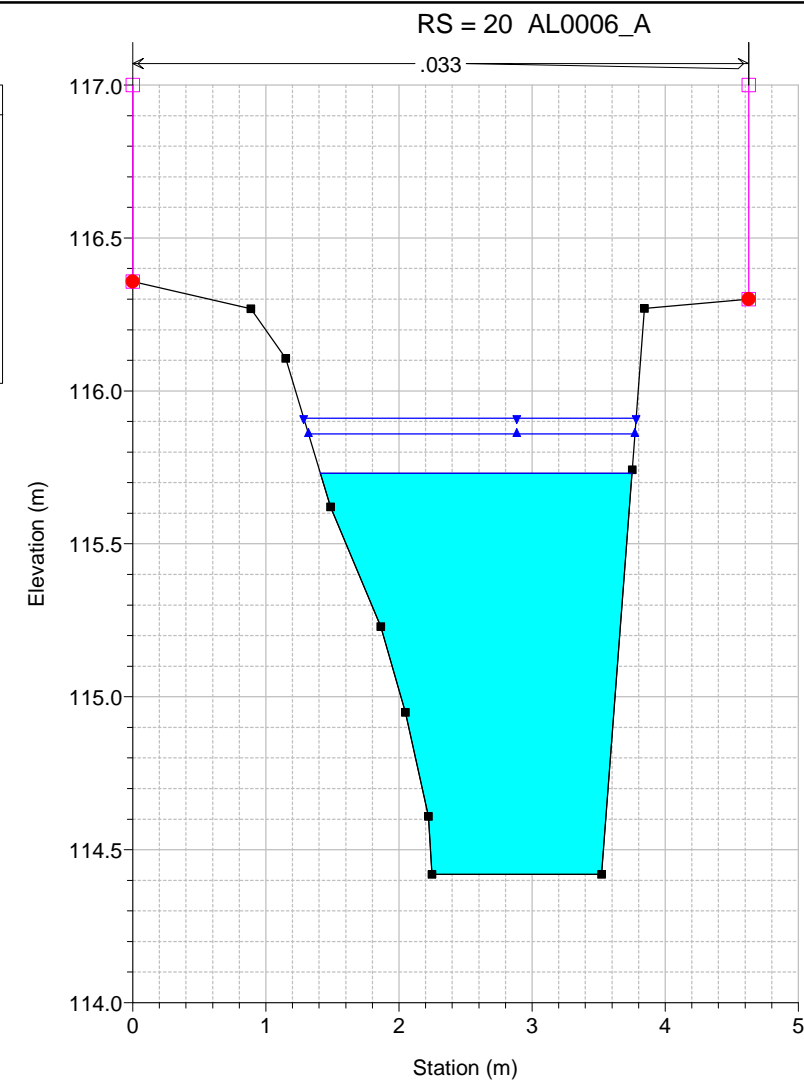
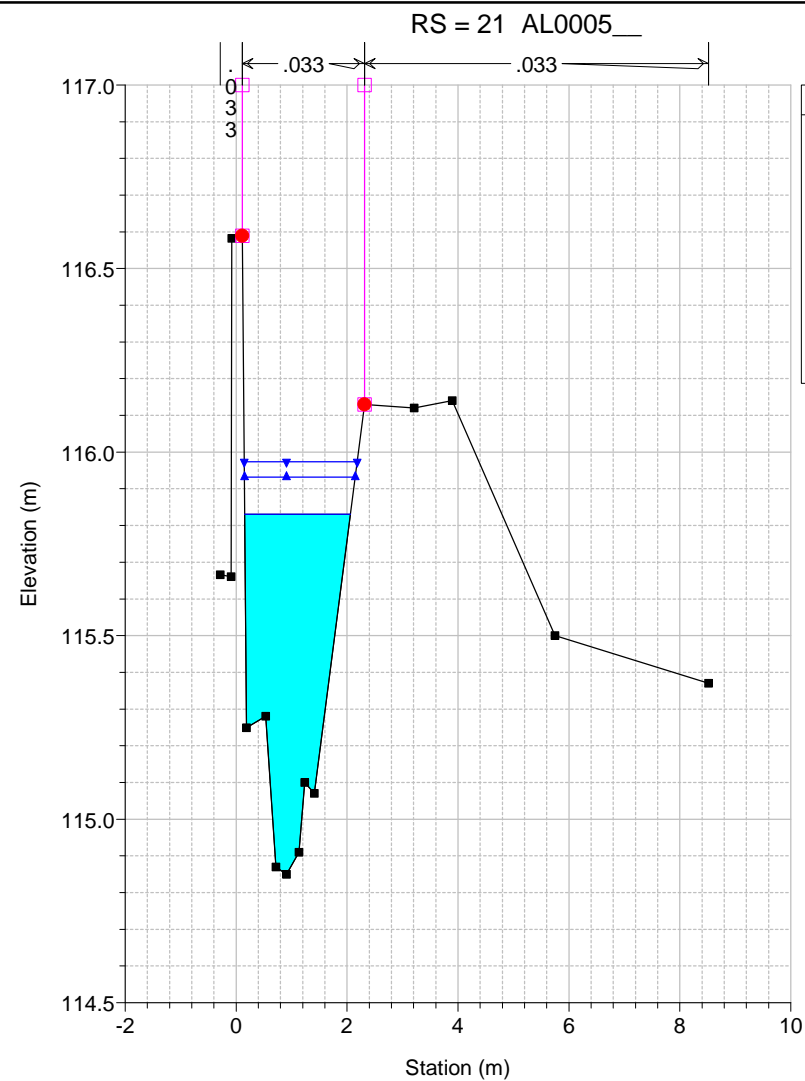
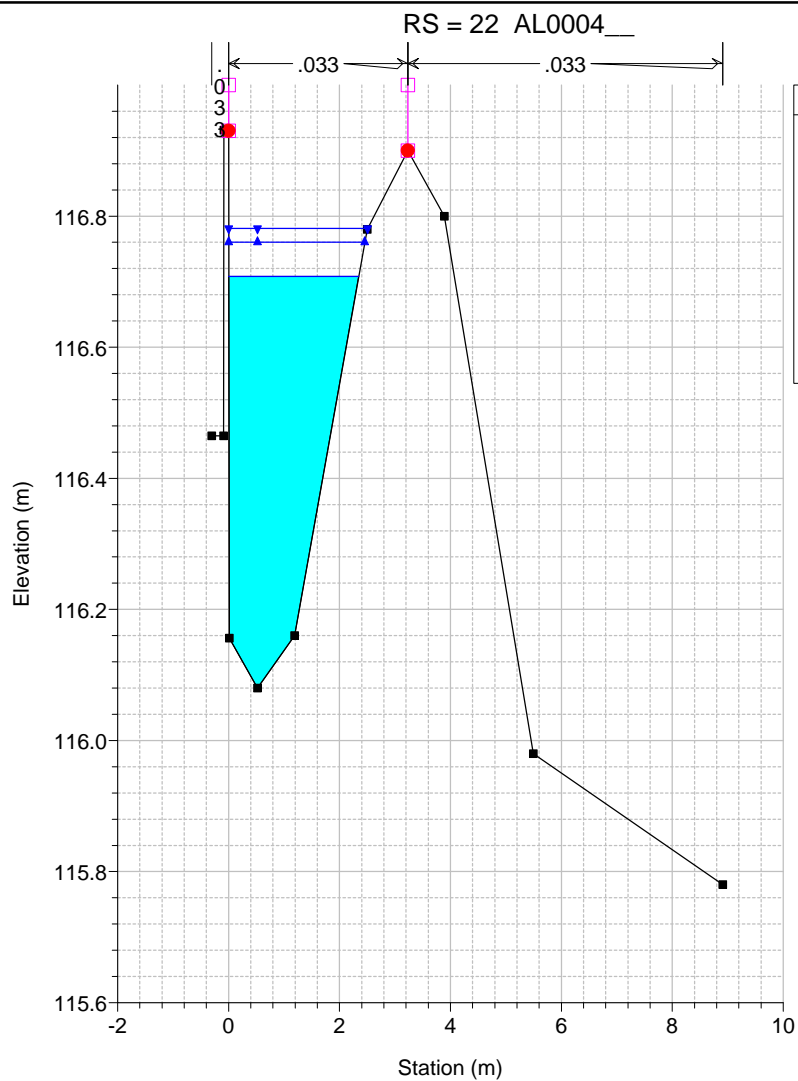

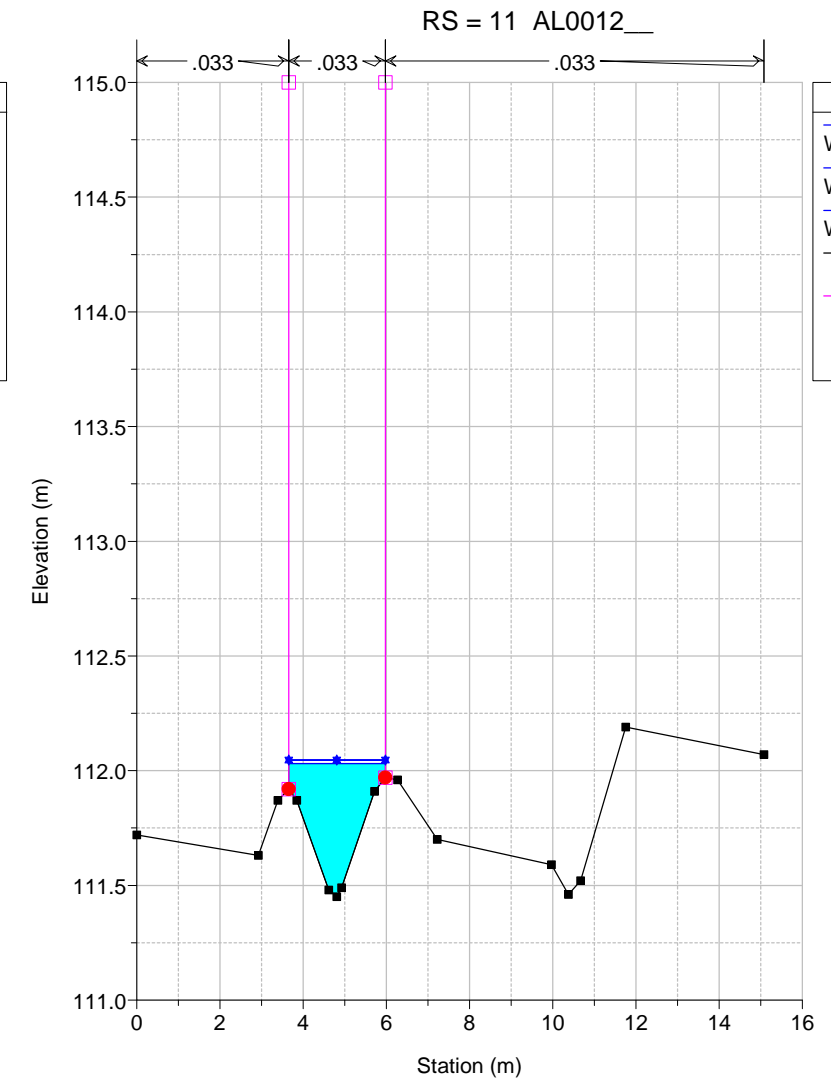
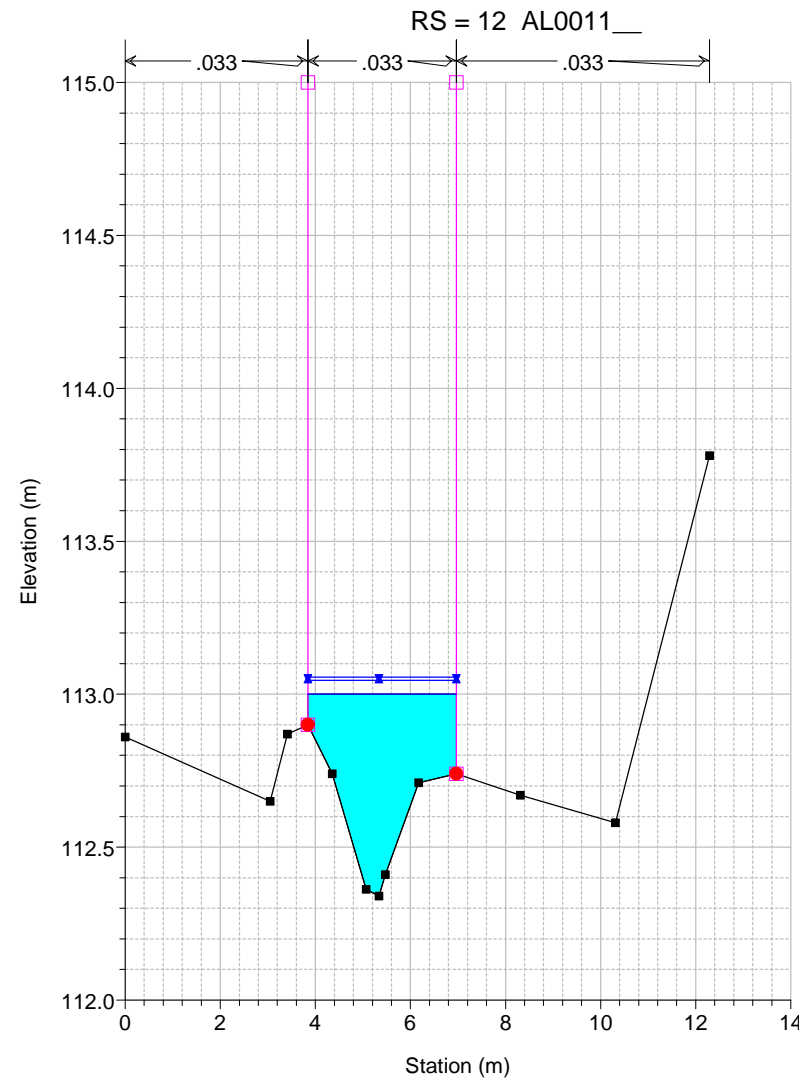
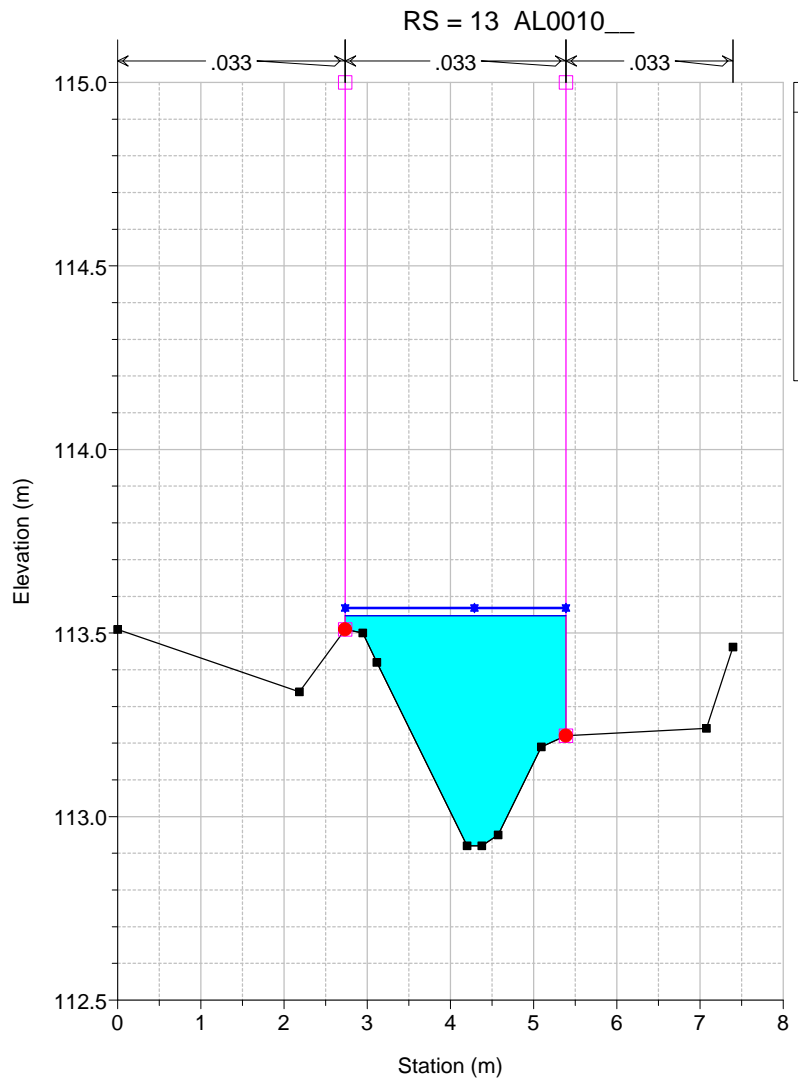
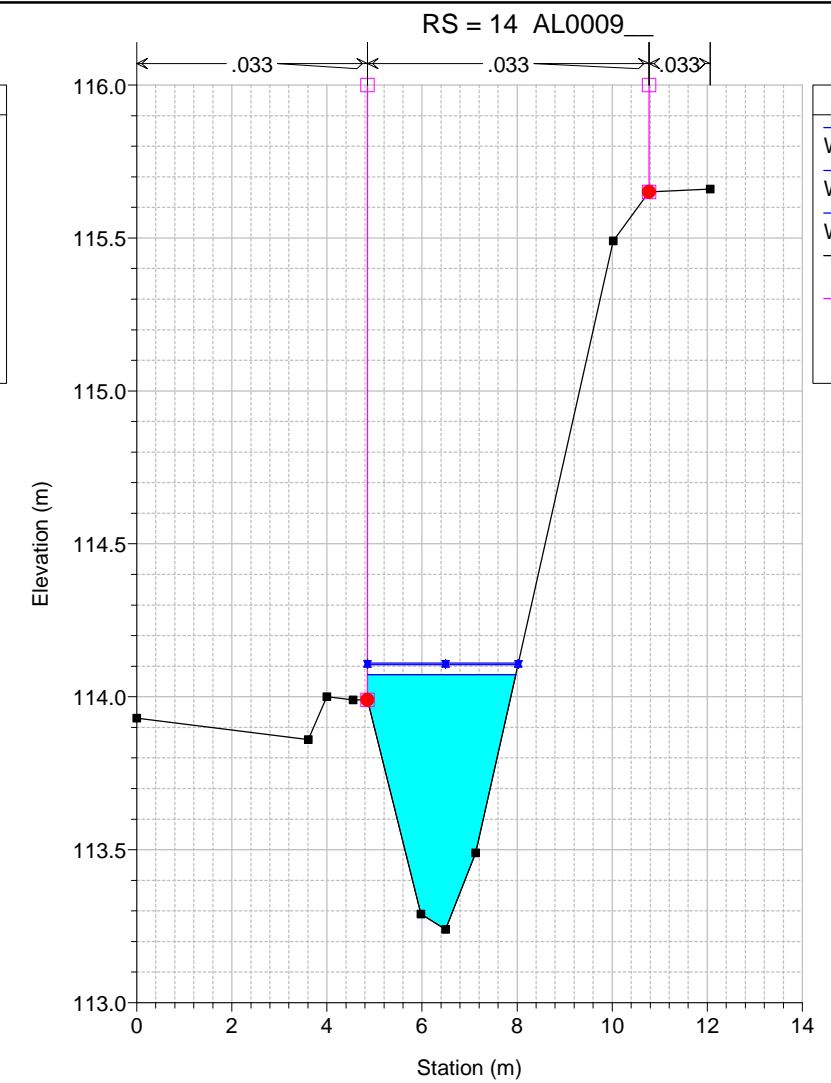
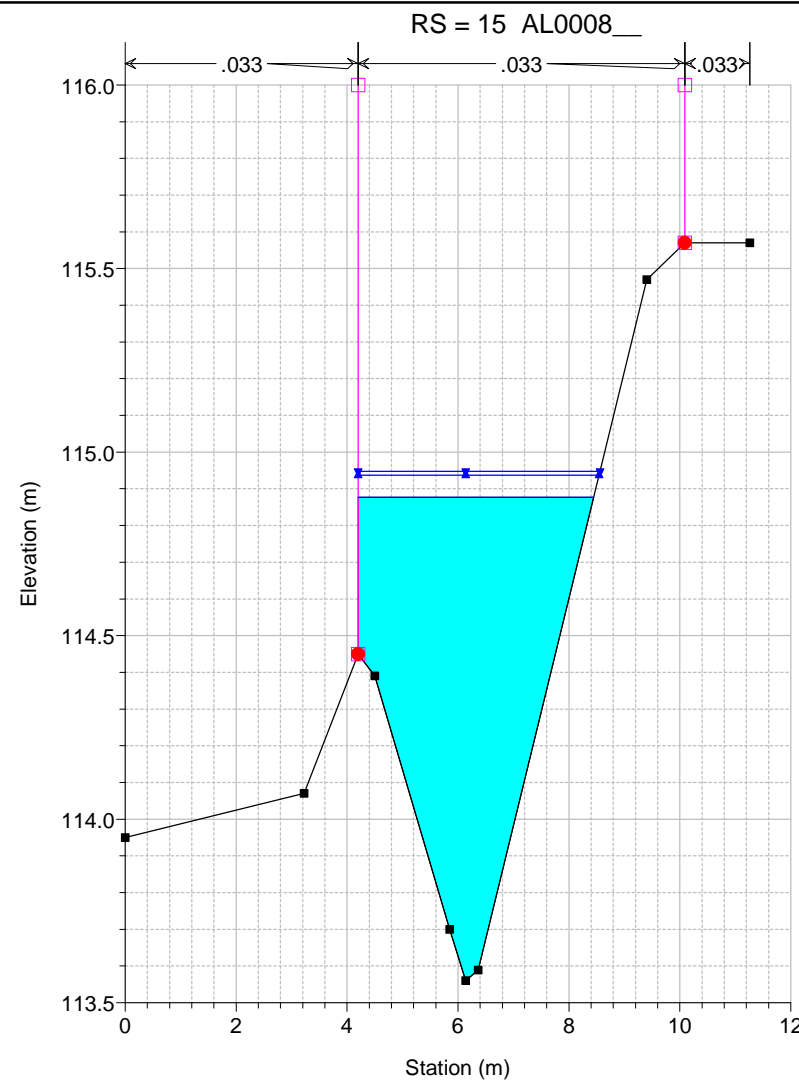
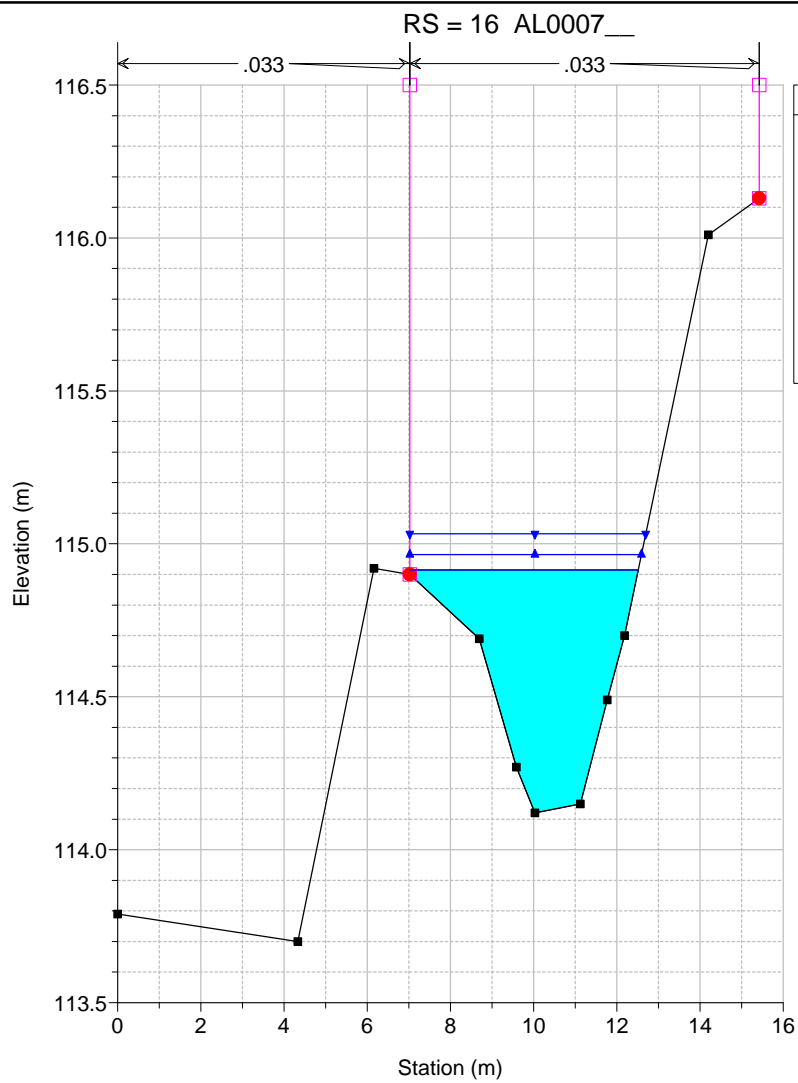

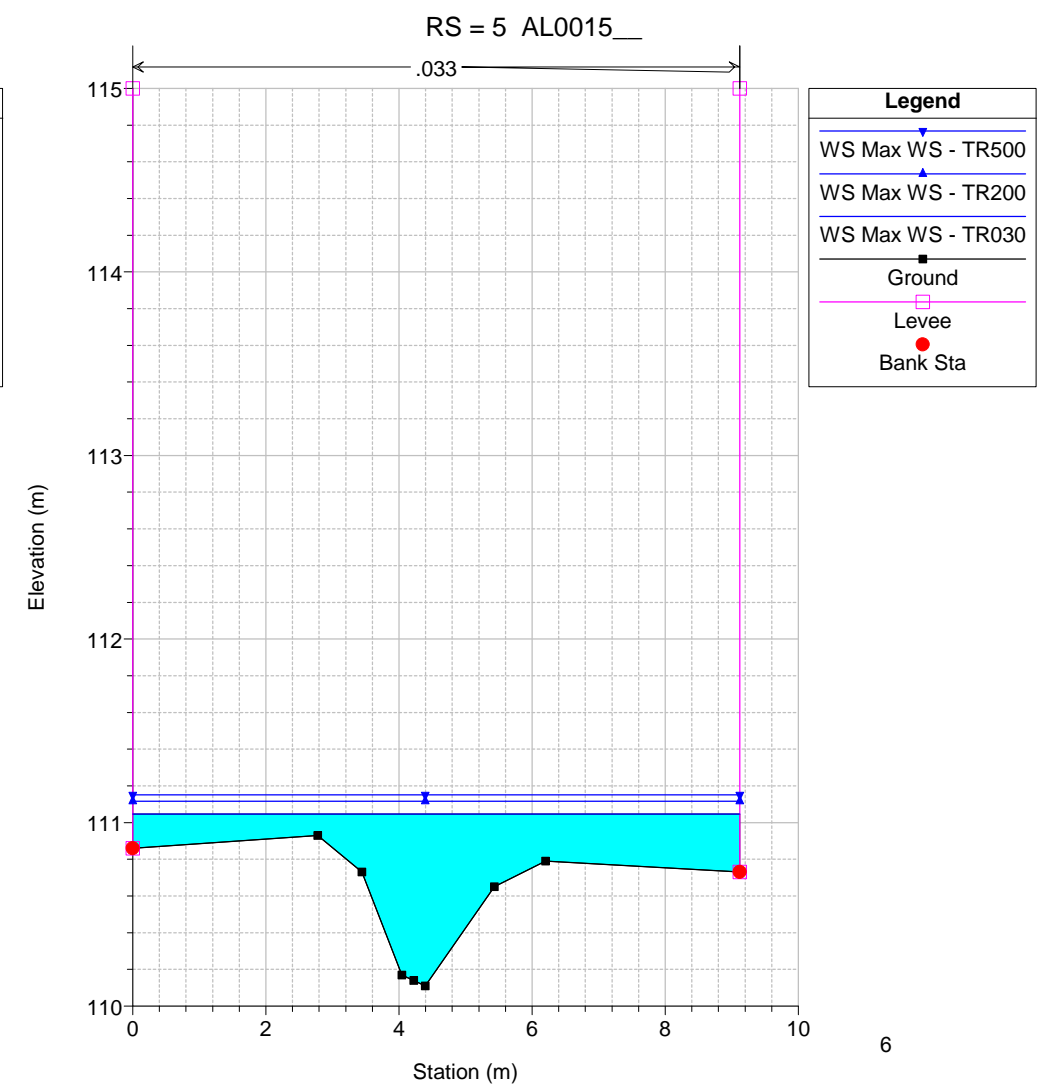
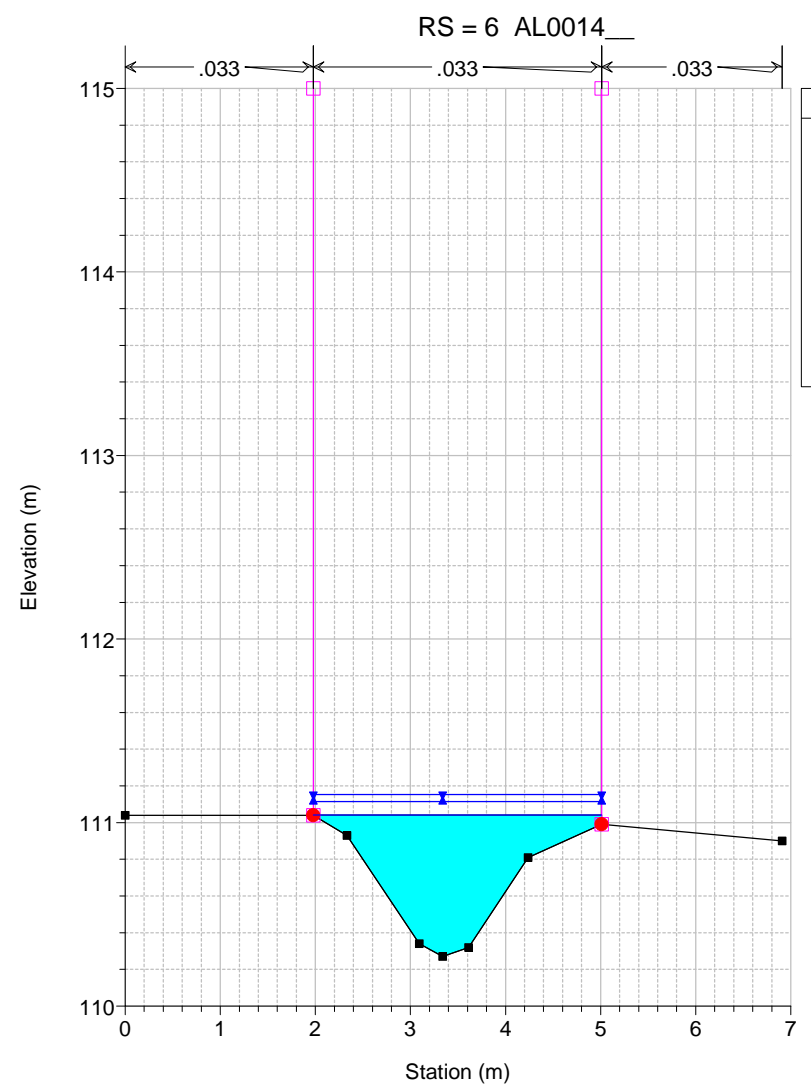
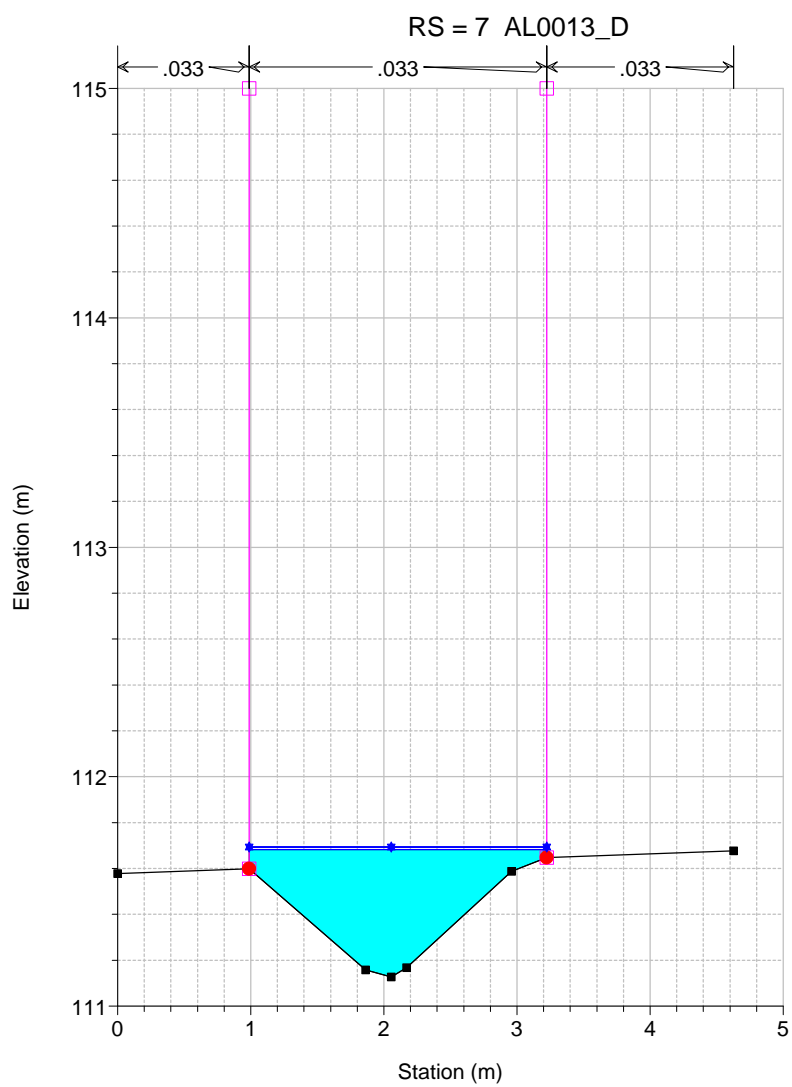
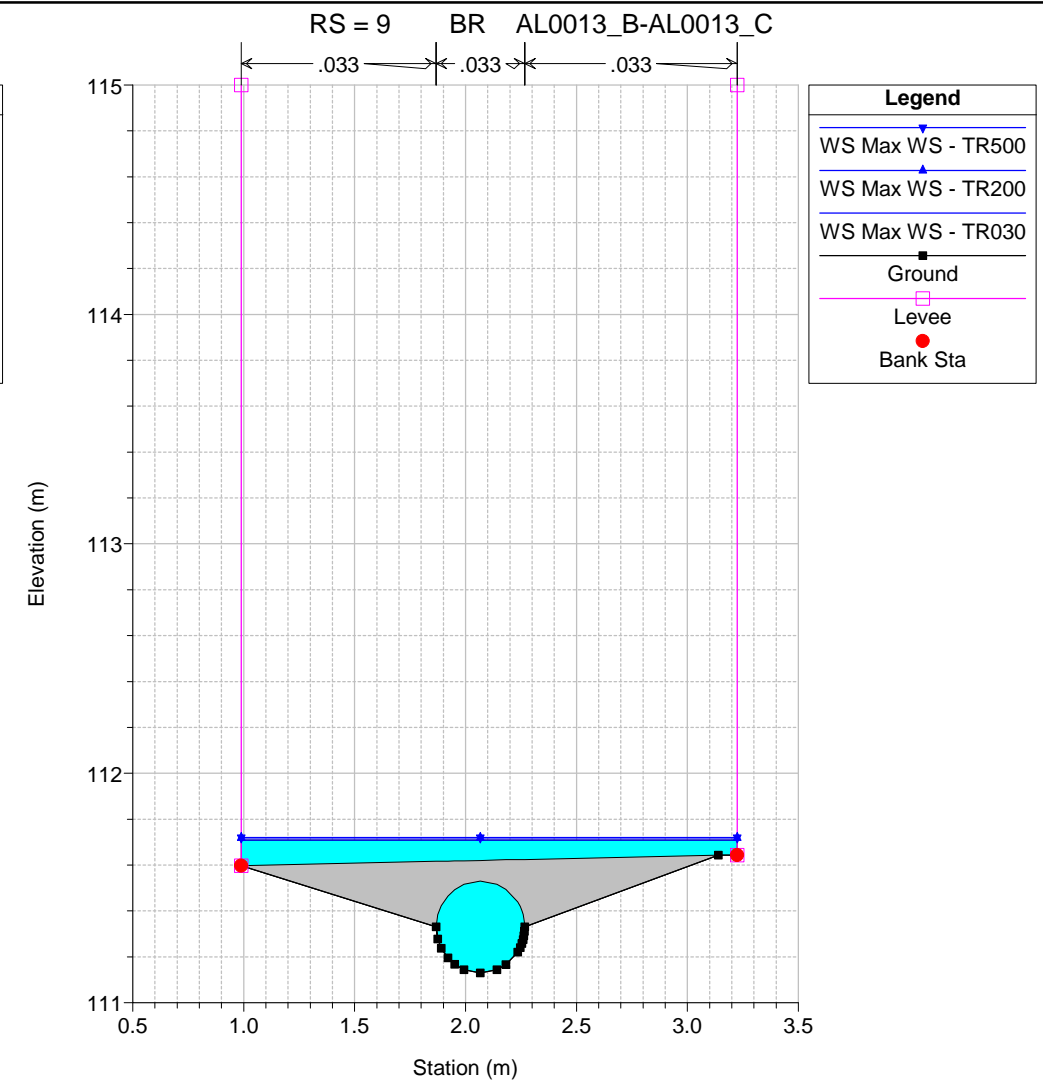
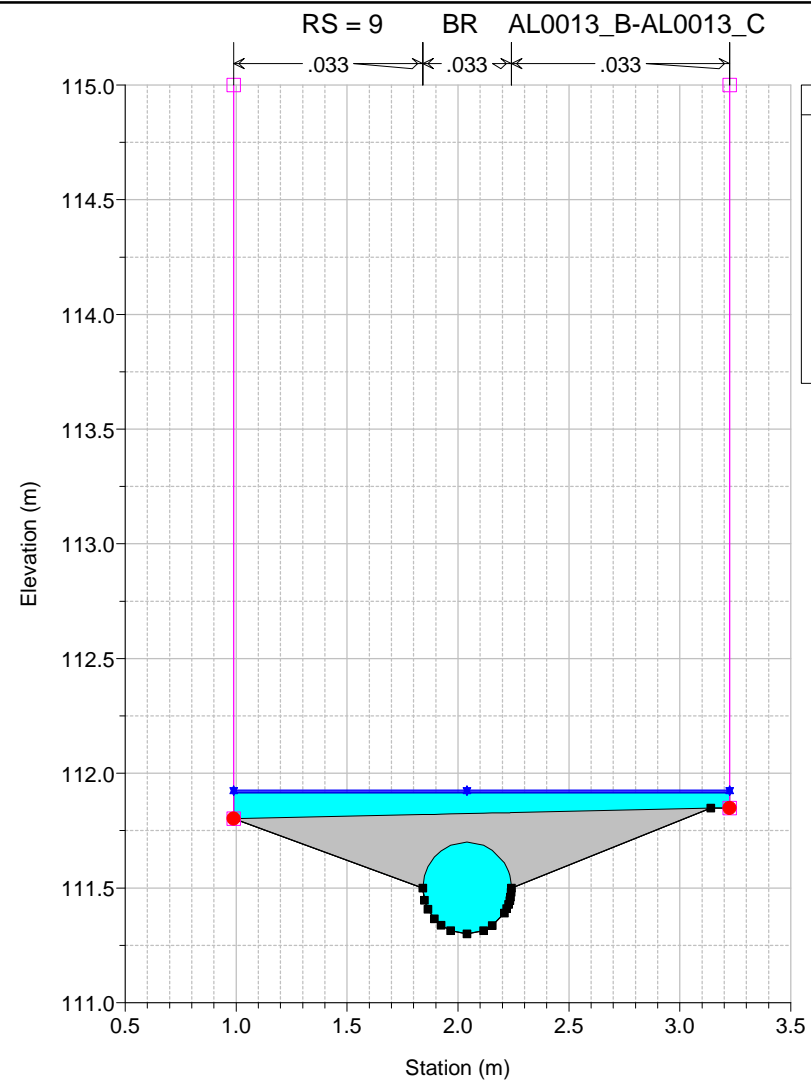
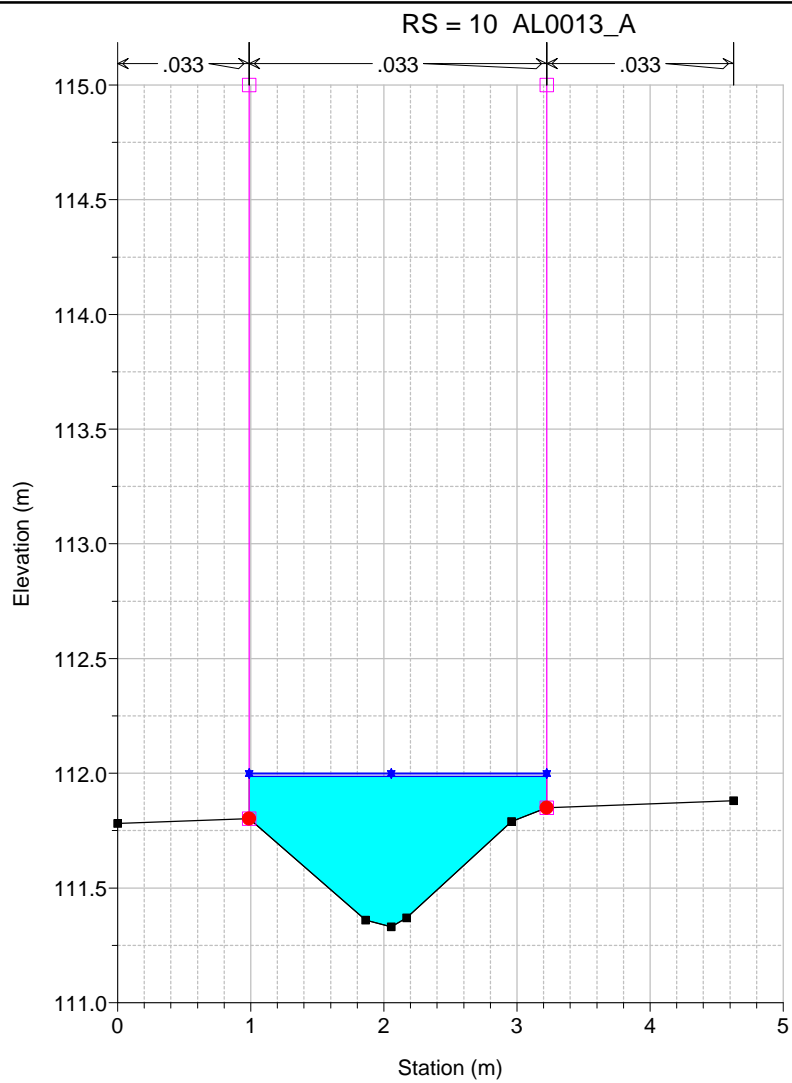

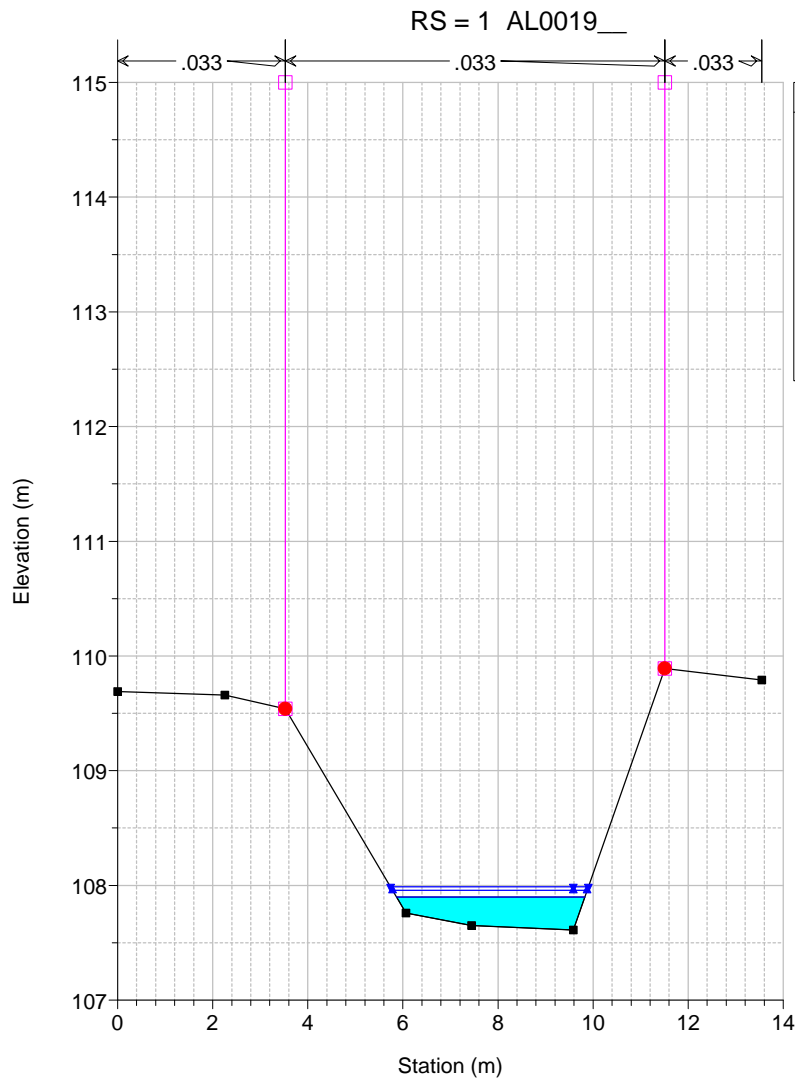
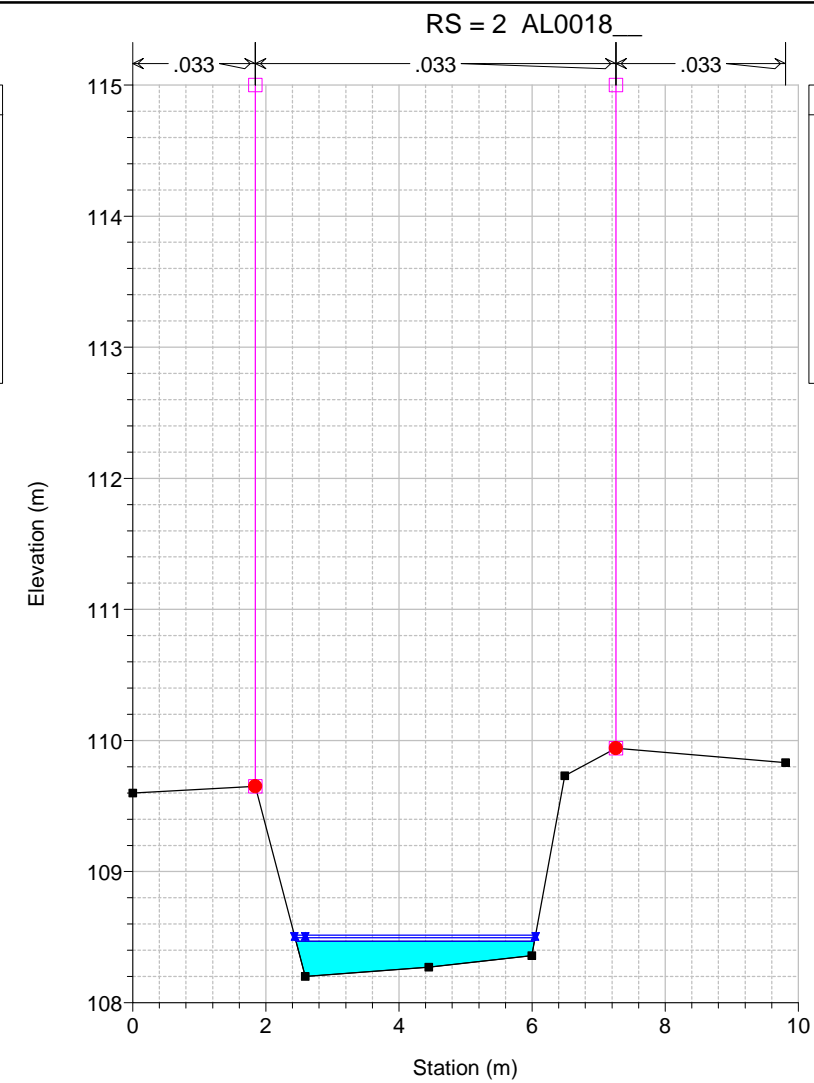
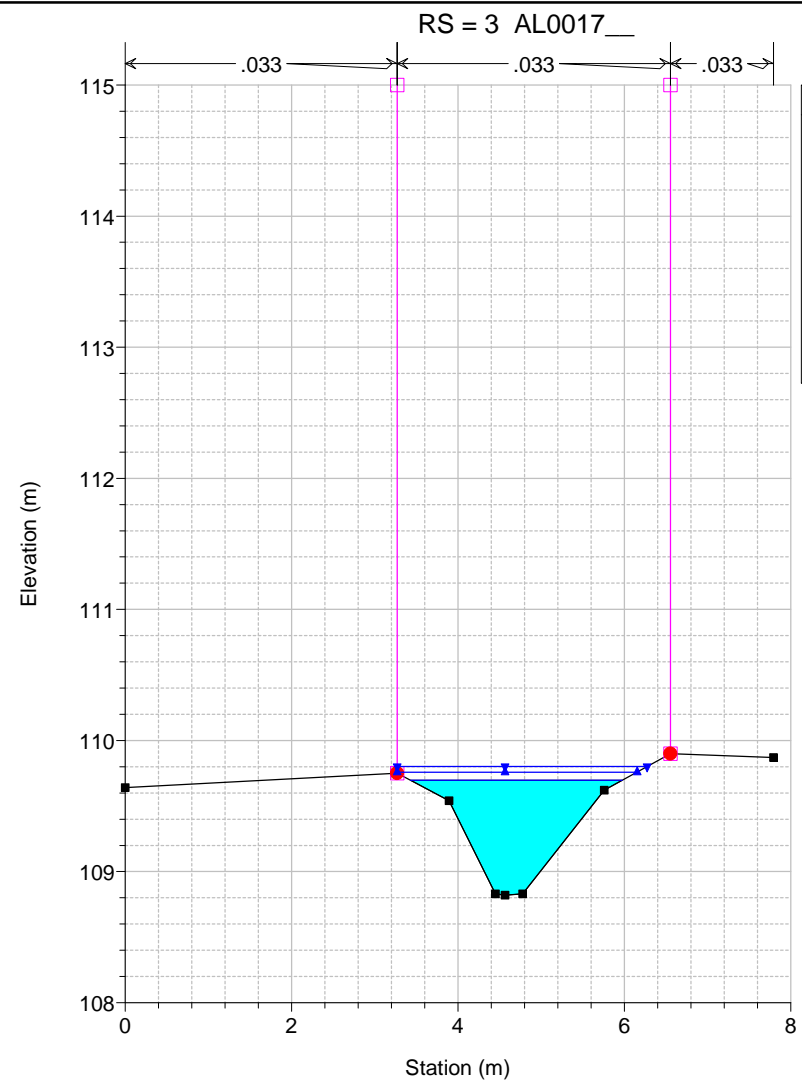
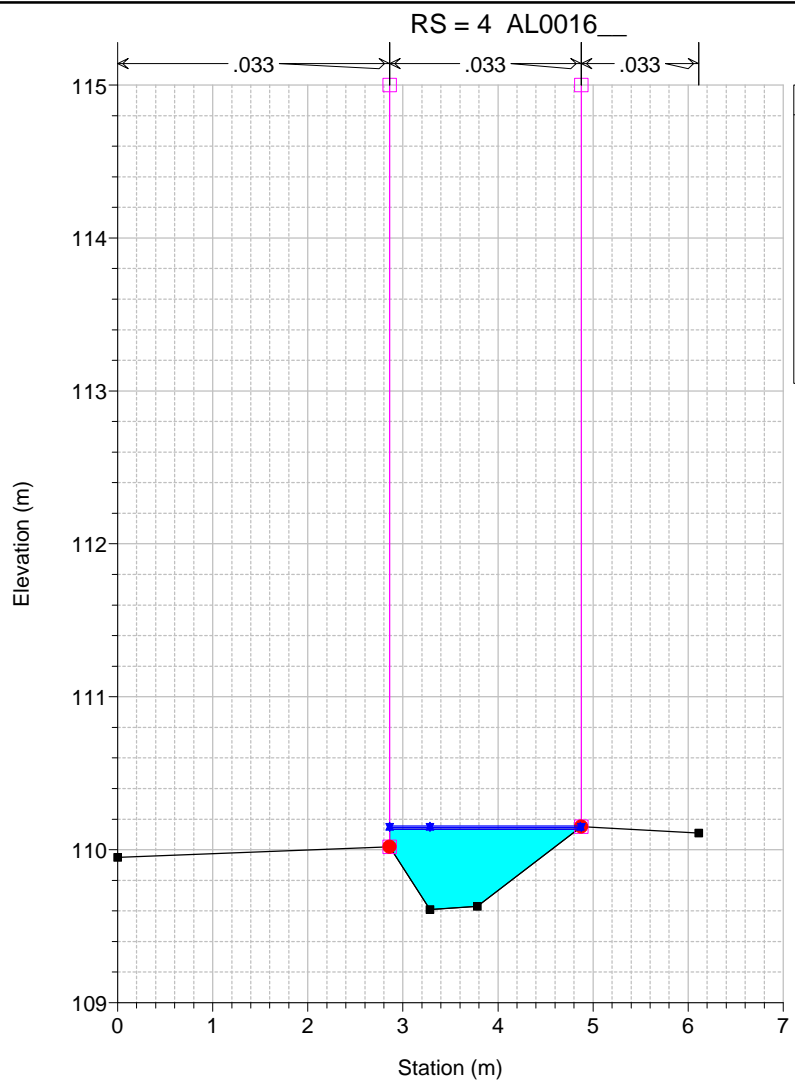

Sezioni fluviali
Fosso Borraccino
Tempo di ritorno: 30, 200 e 500 anni

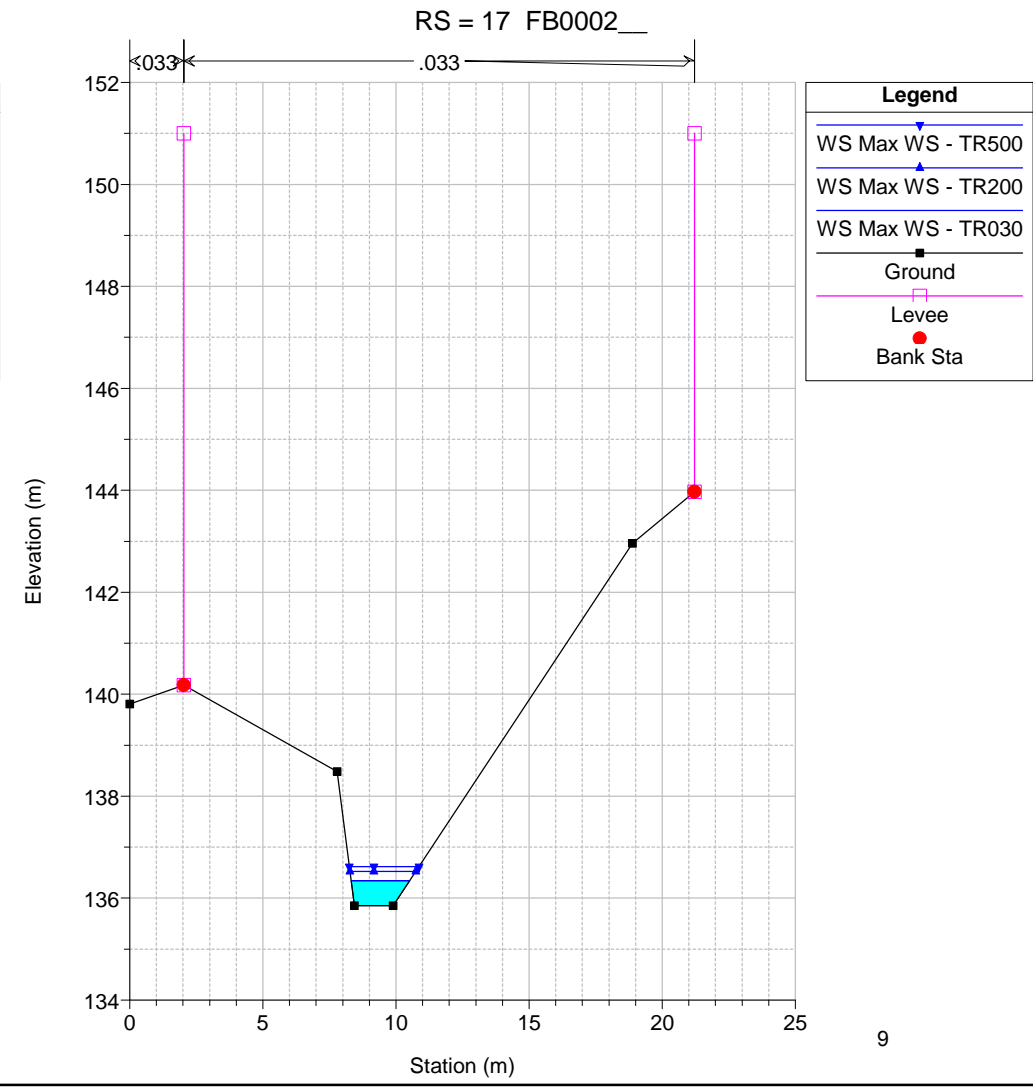
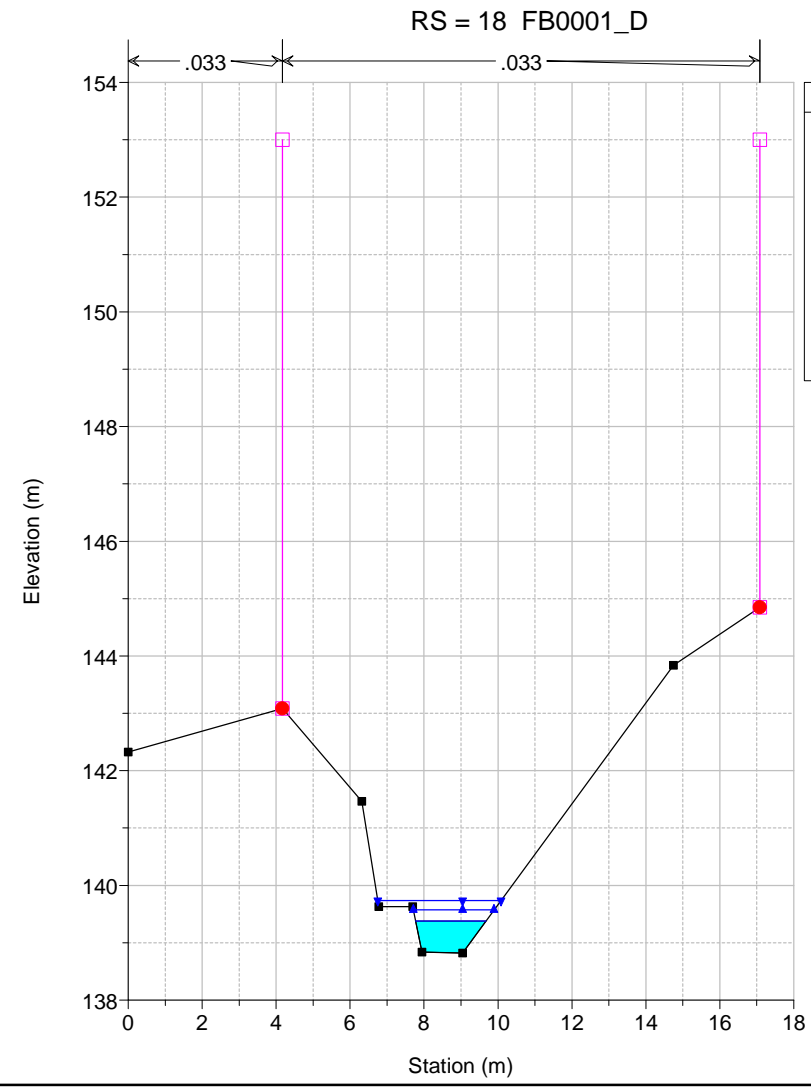
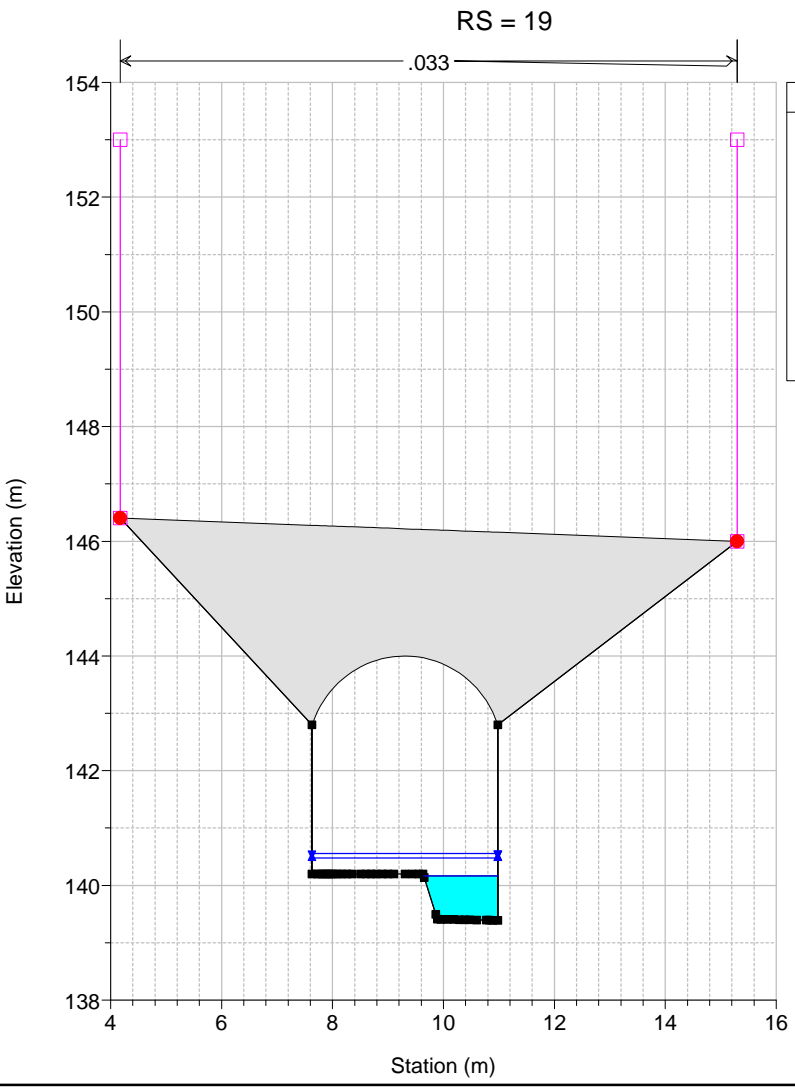
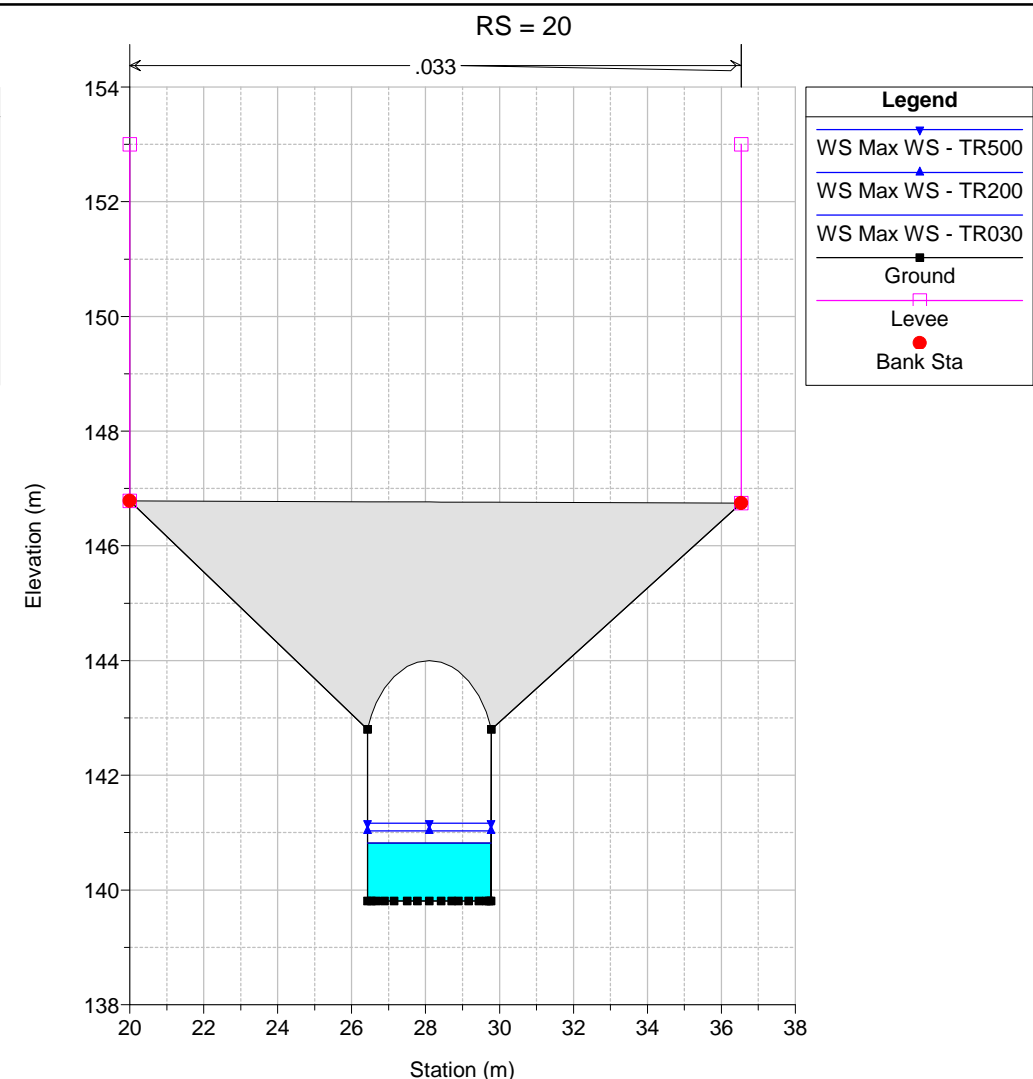
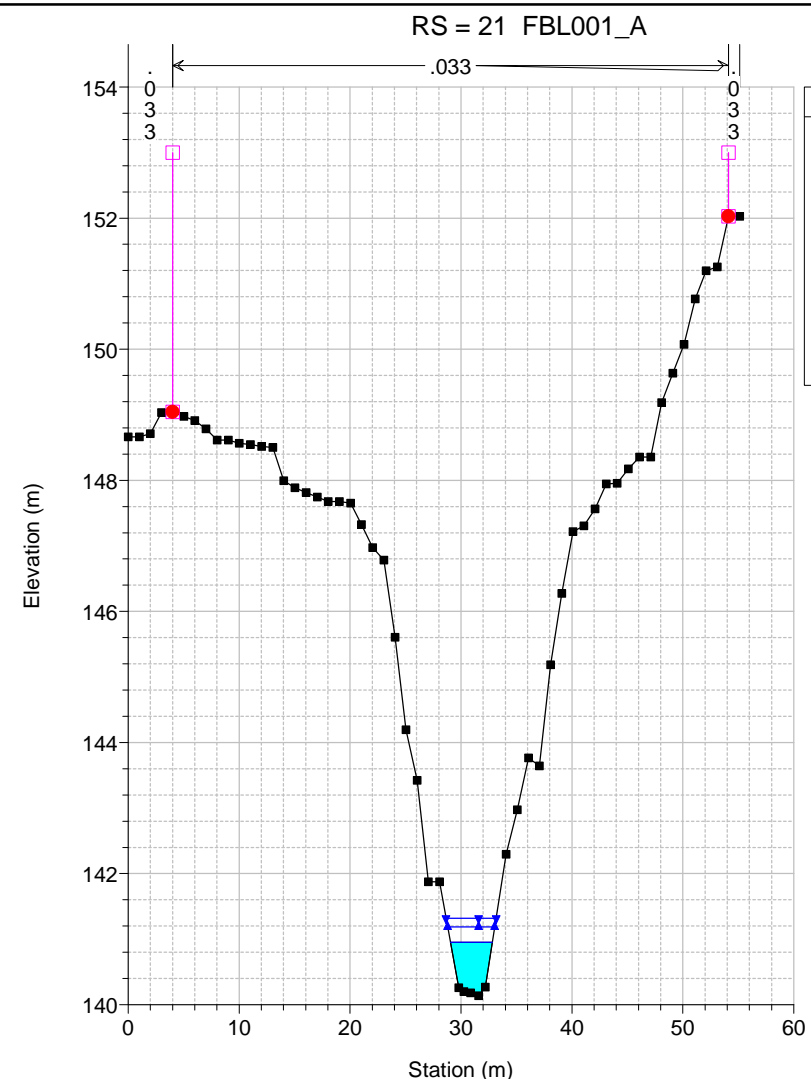
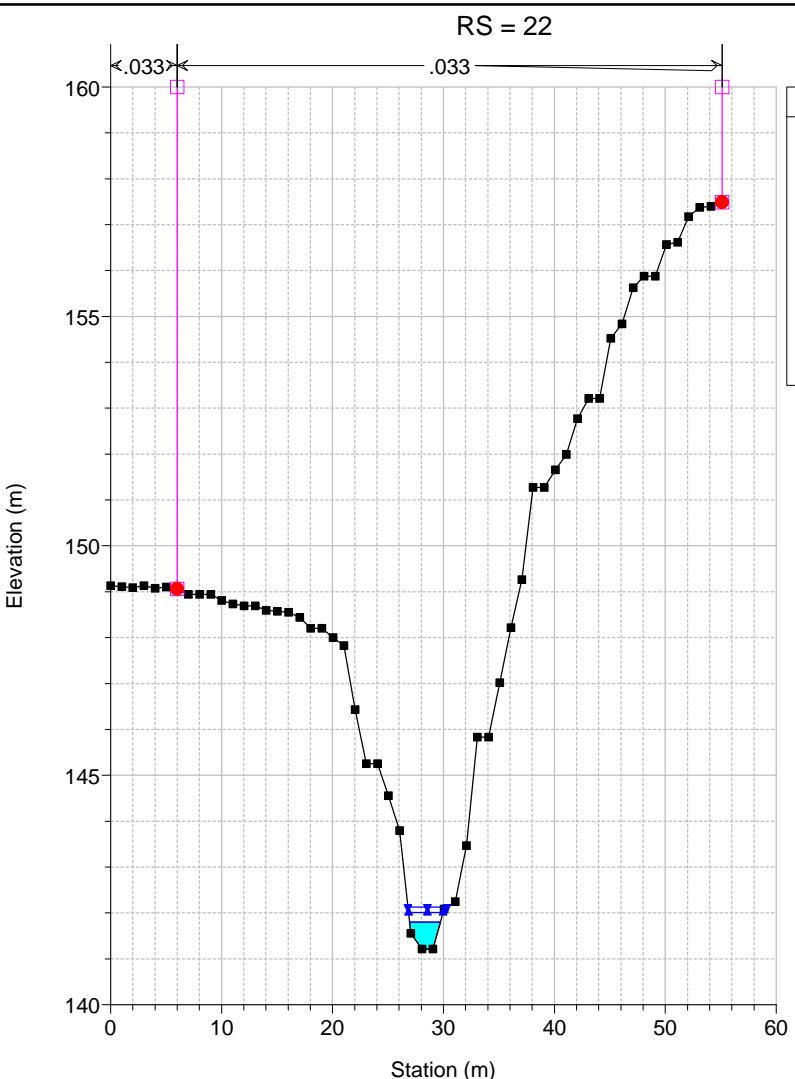

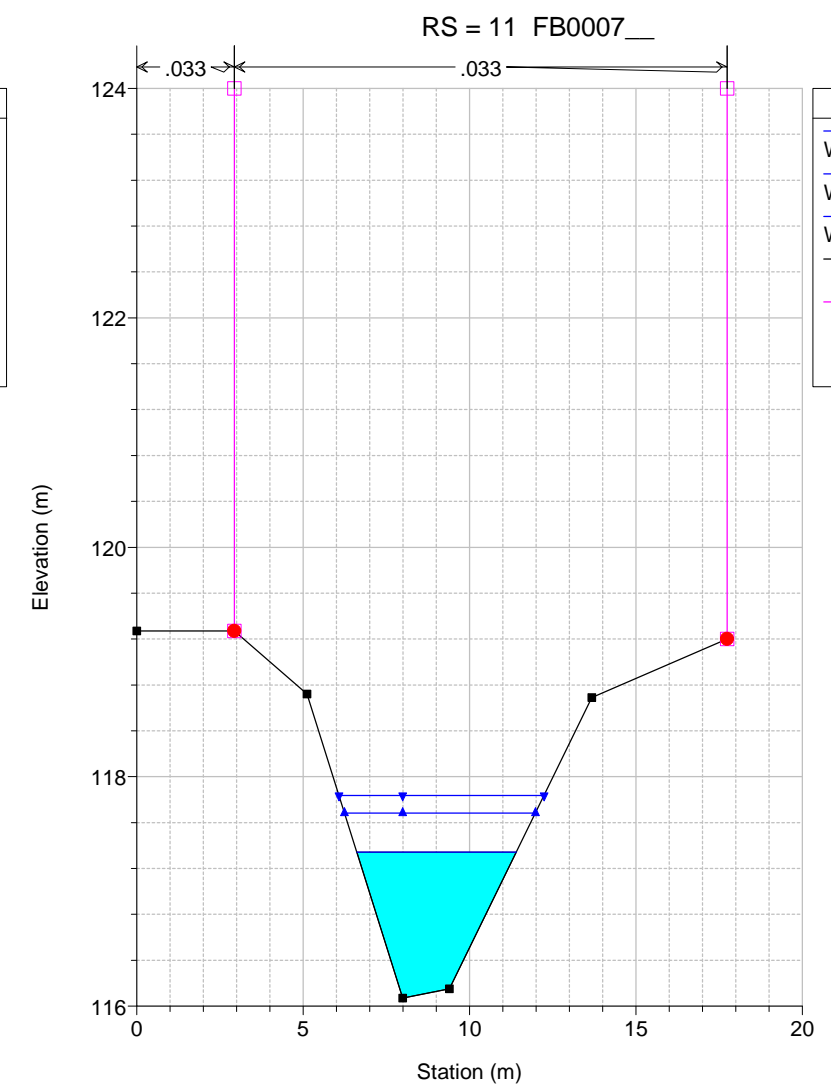
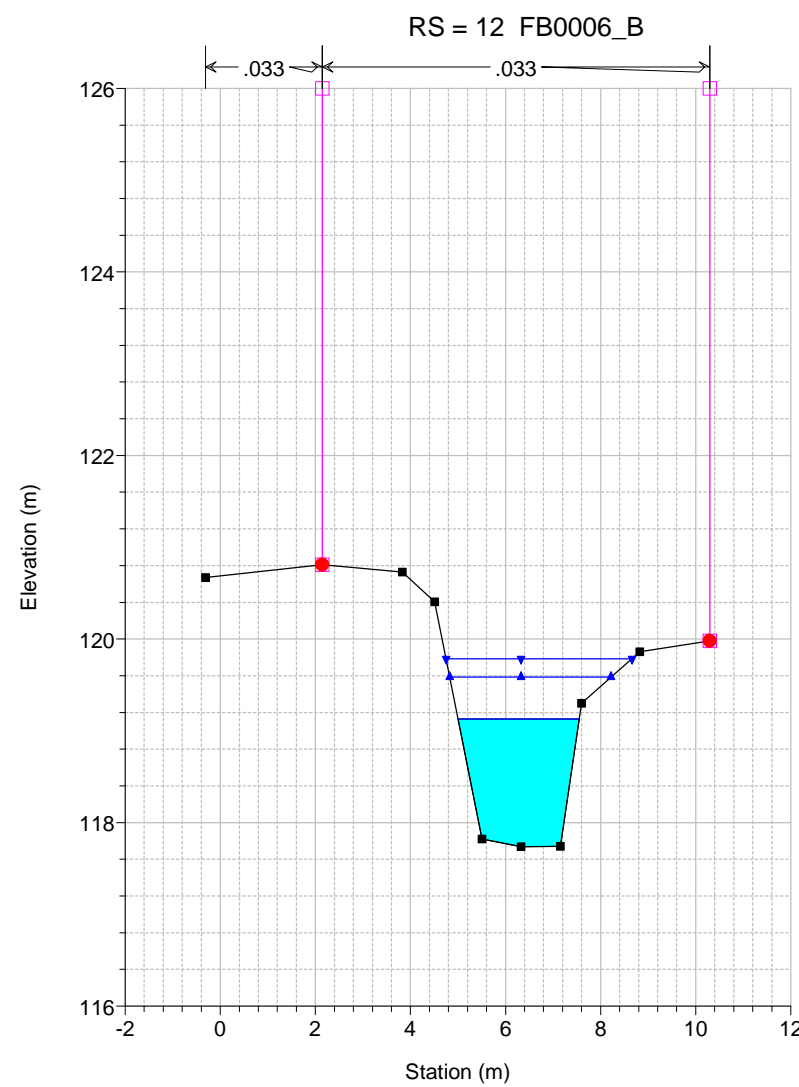
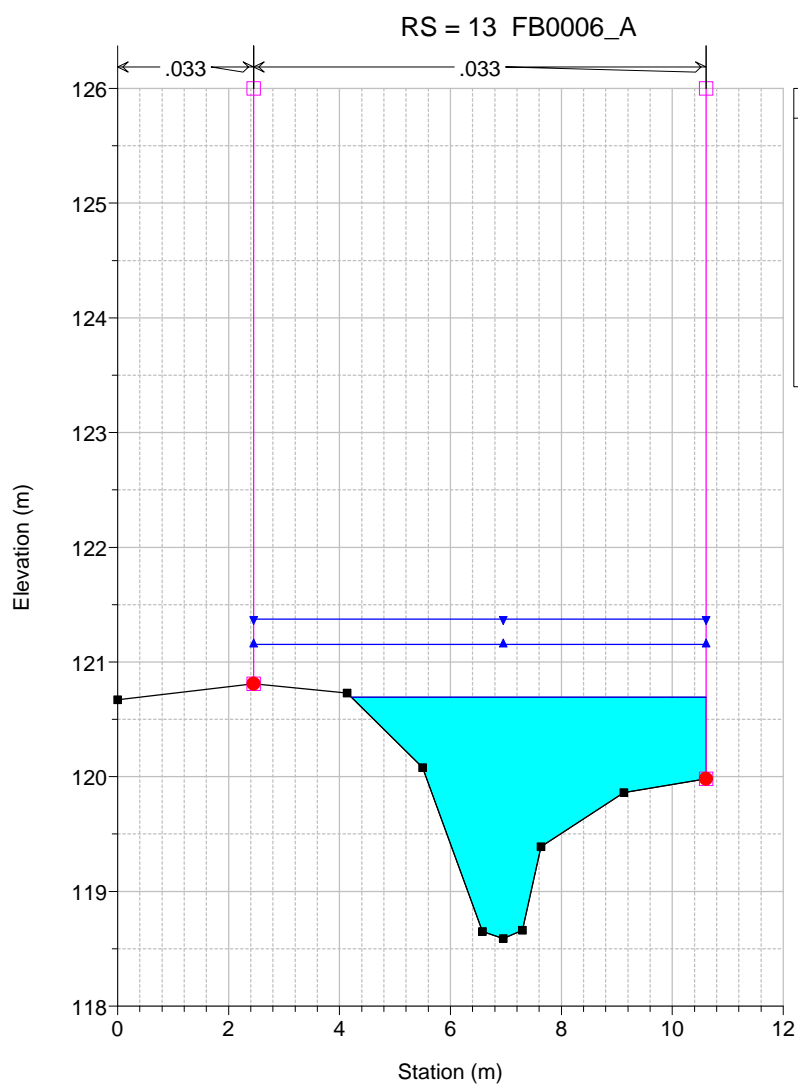
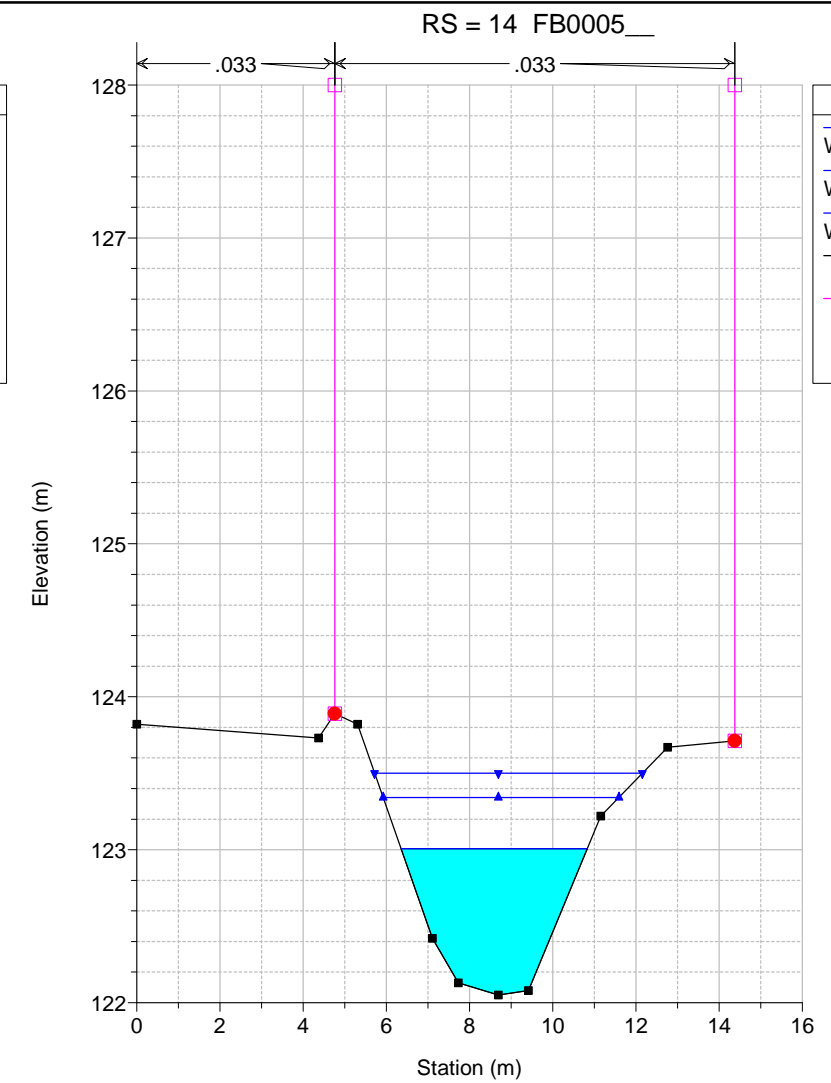
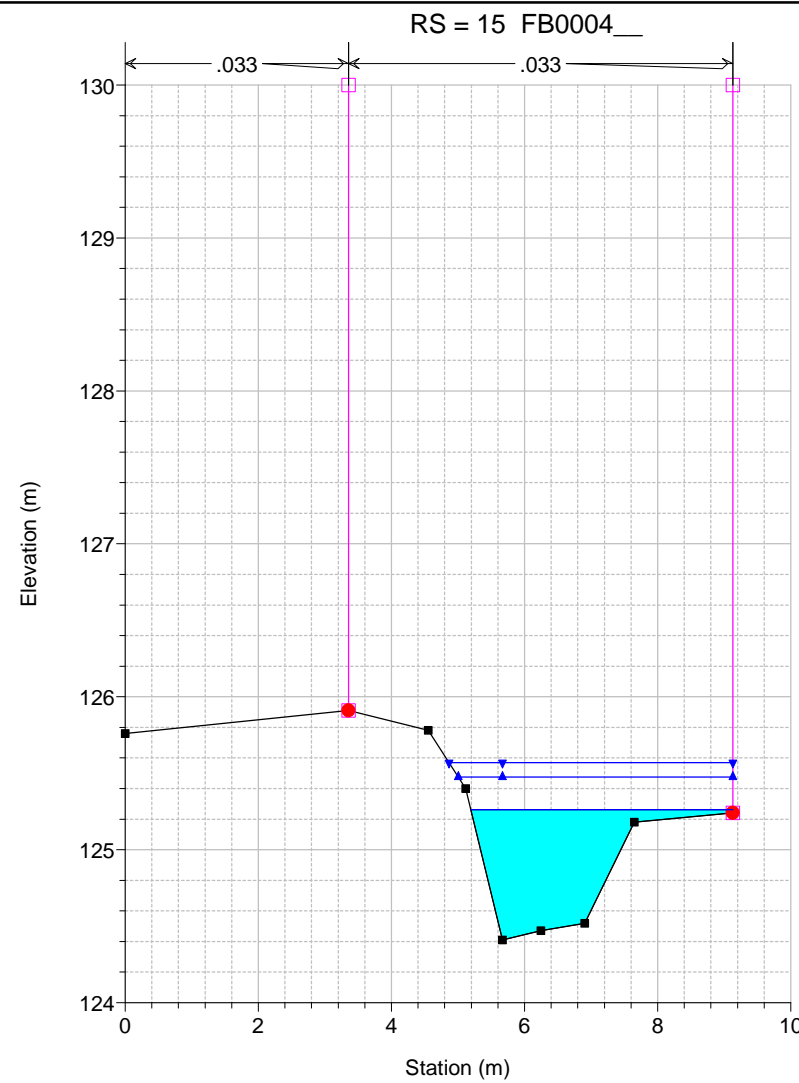
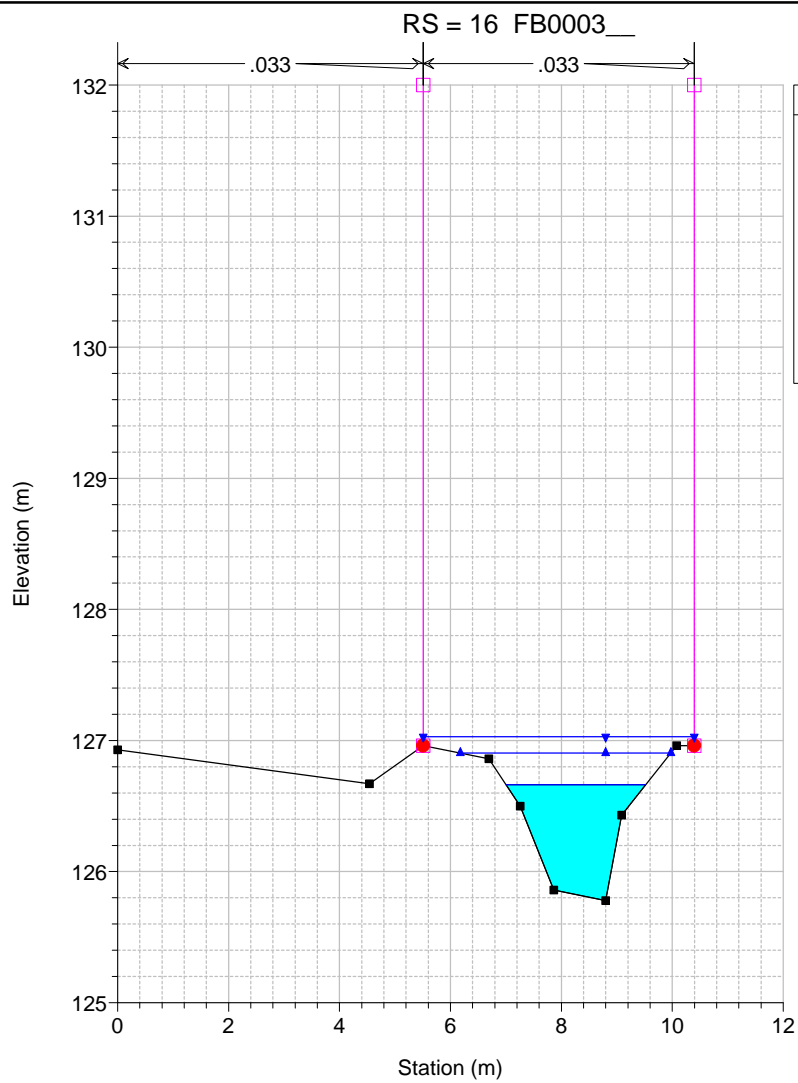

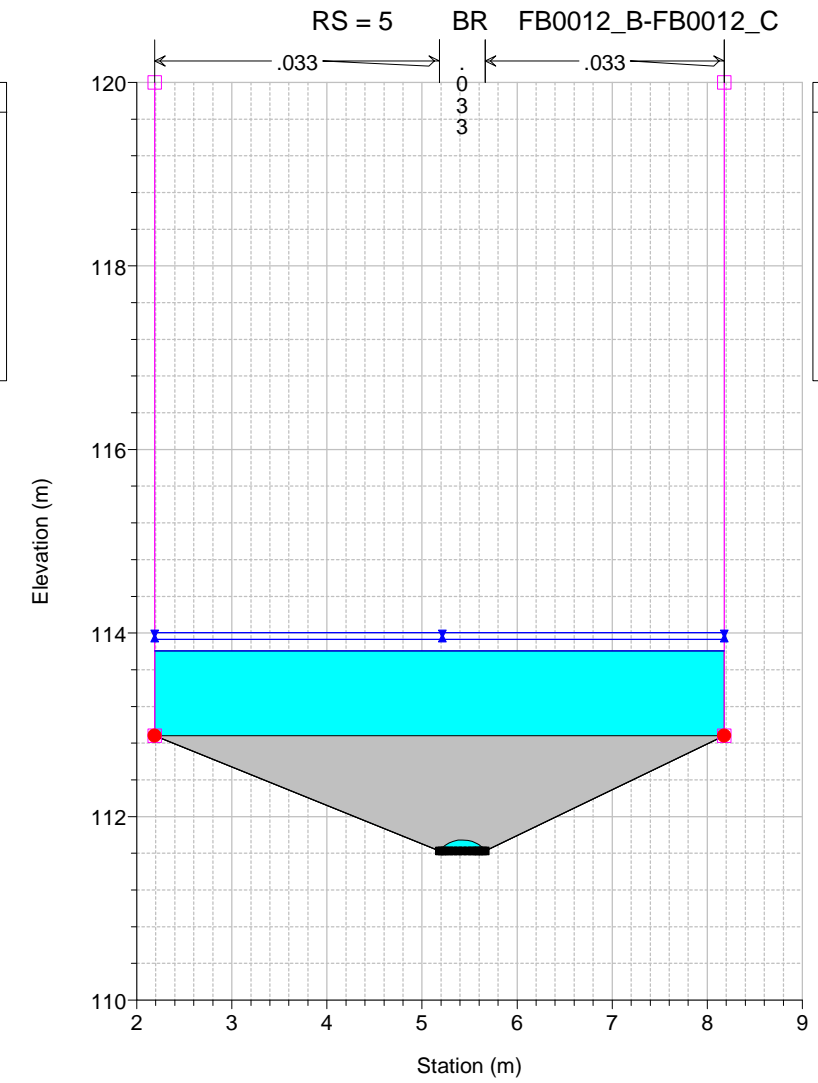
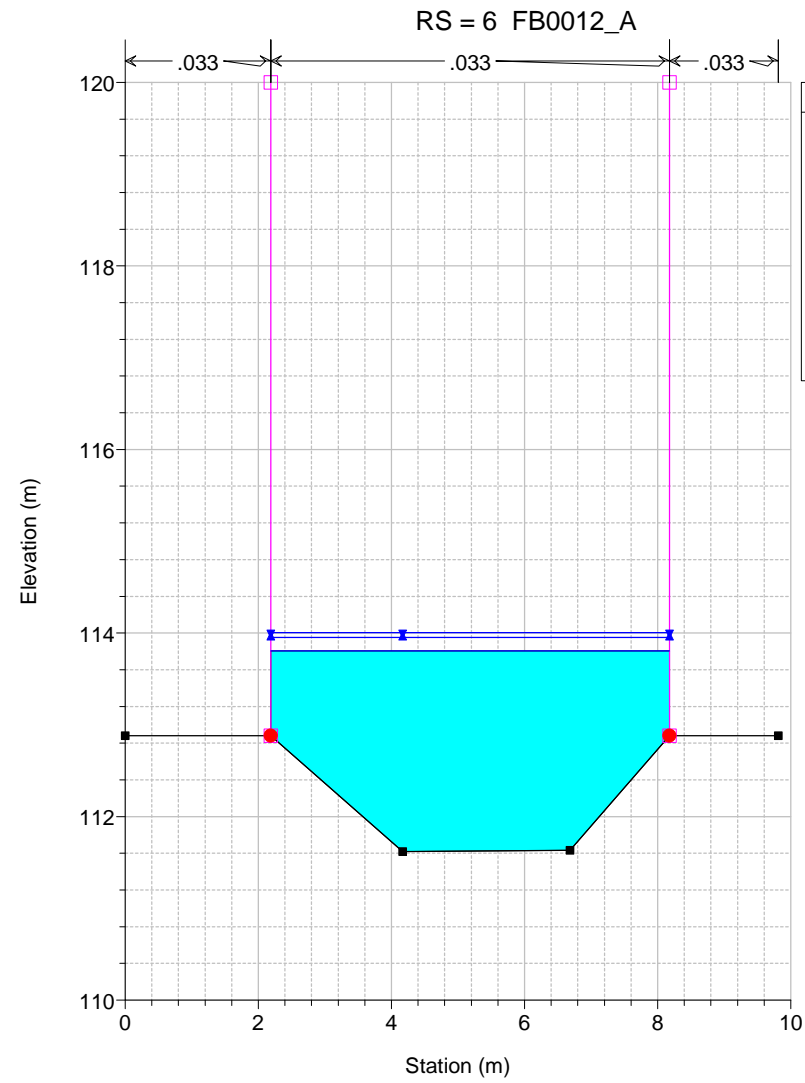
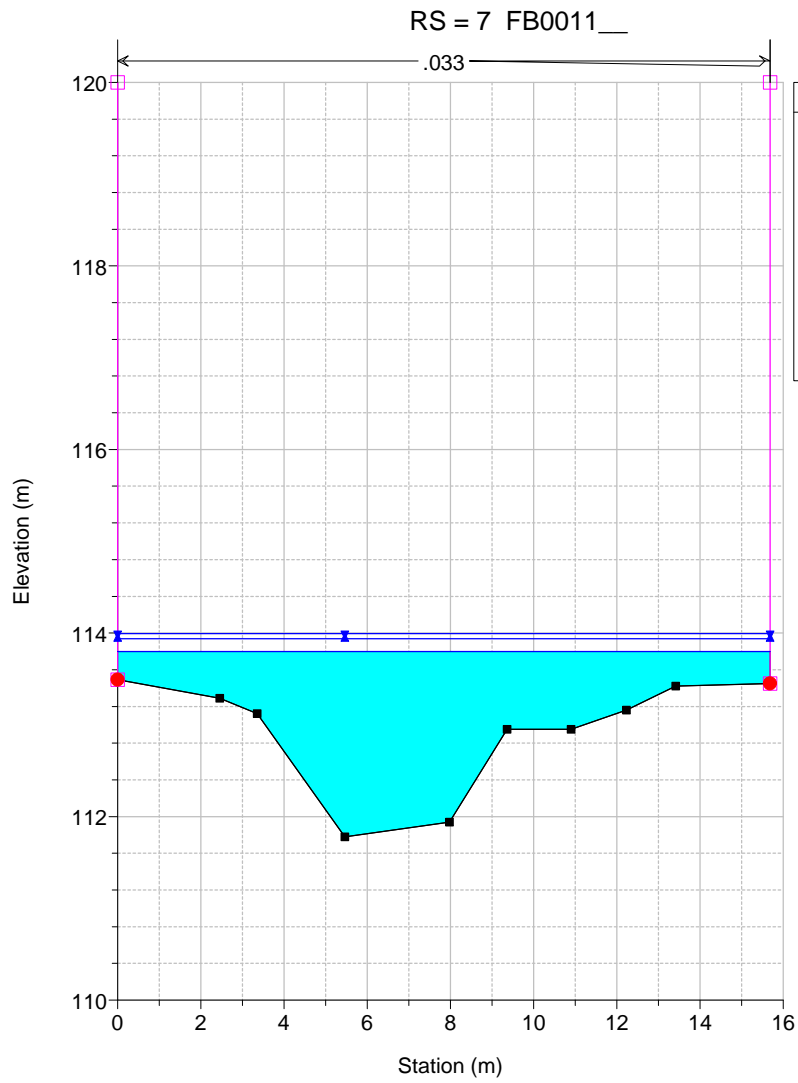
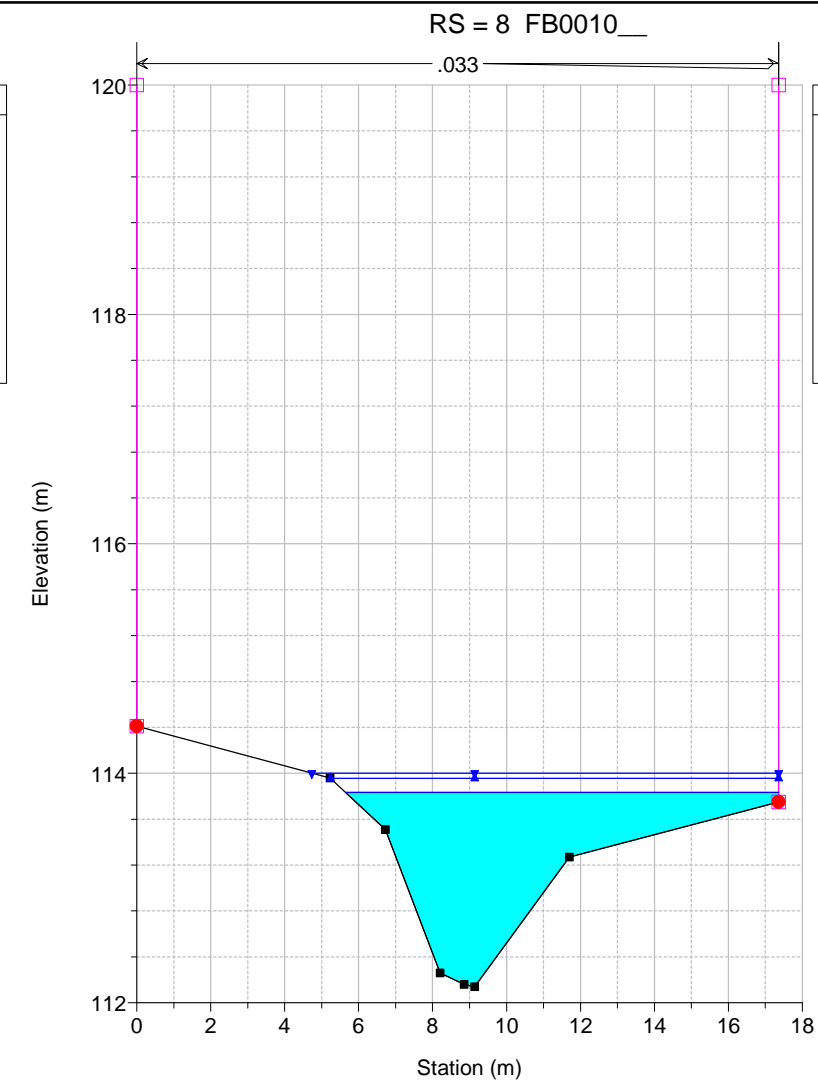
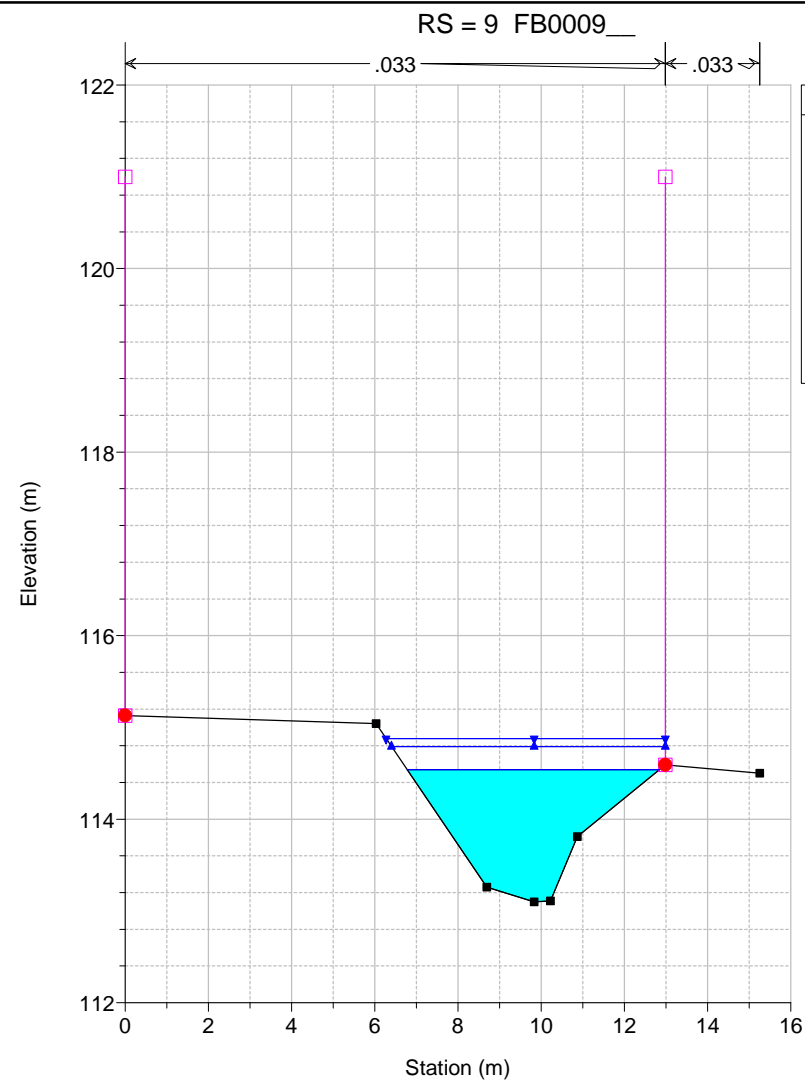
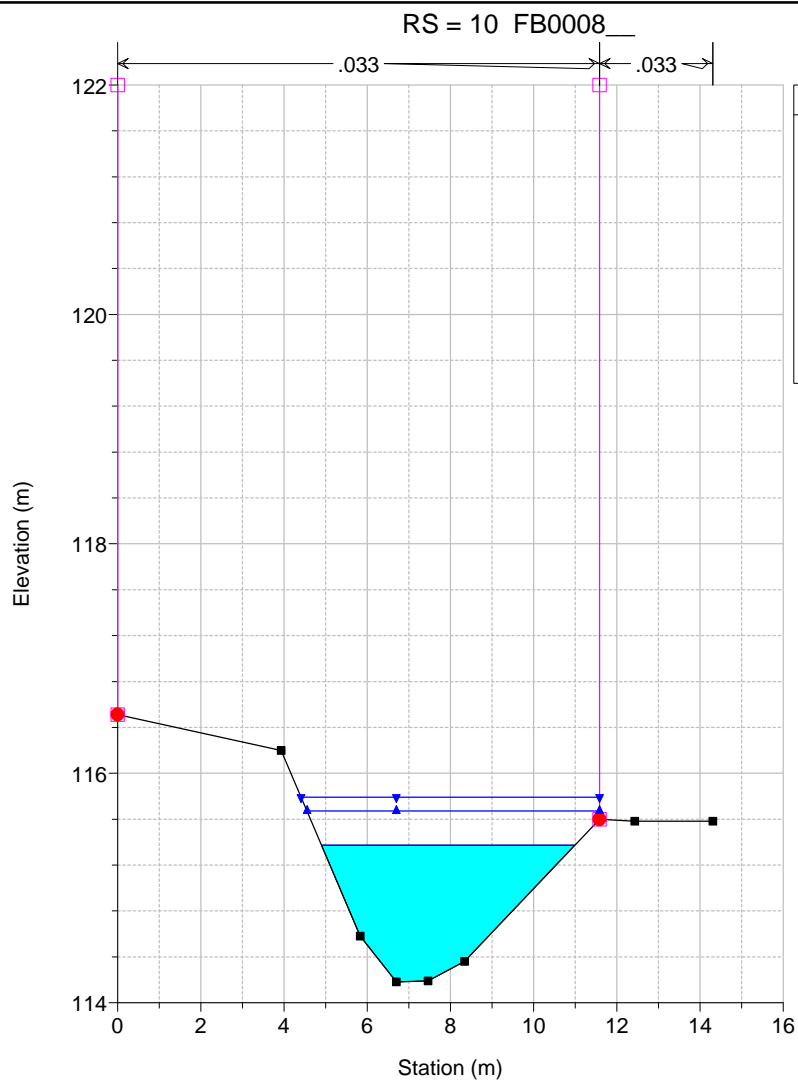

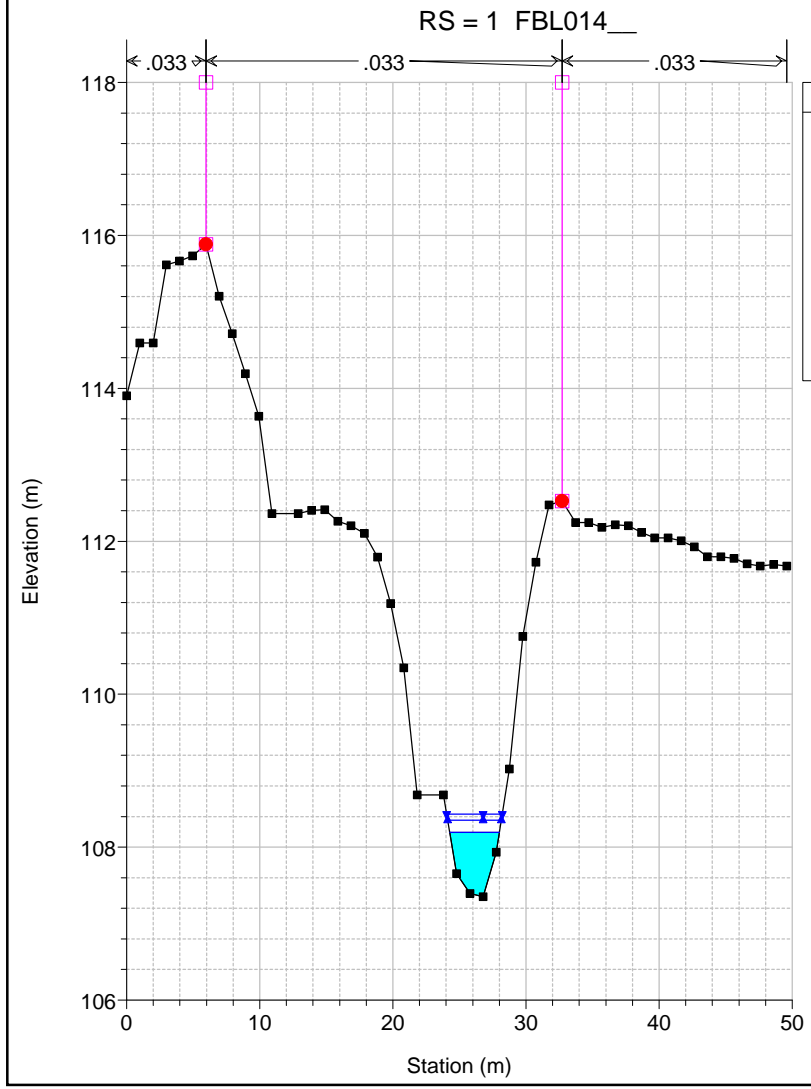
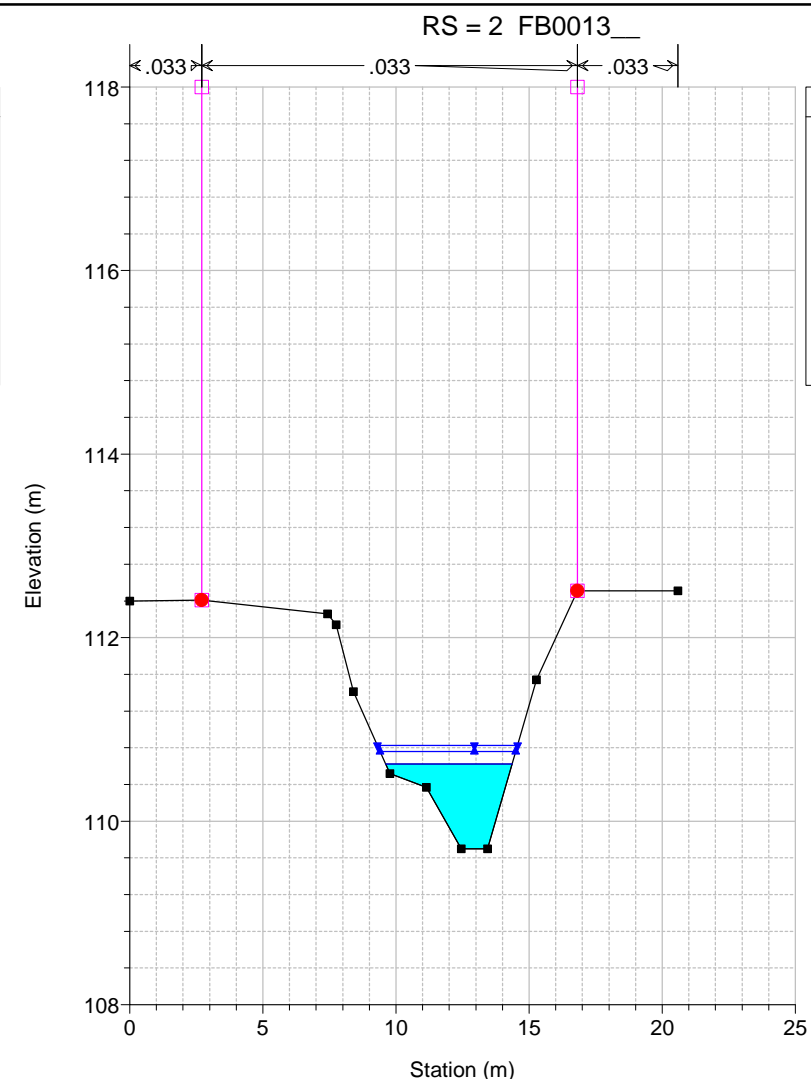
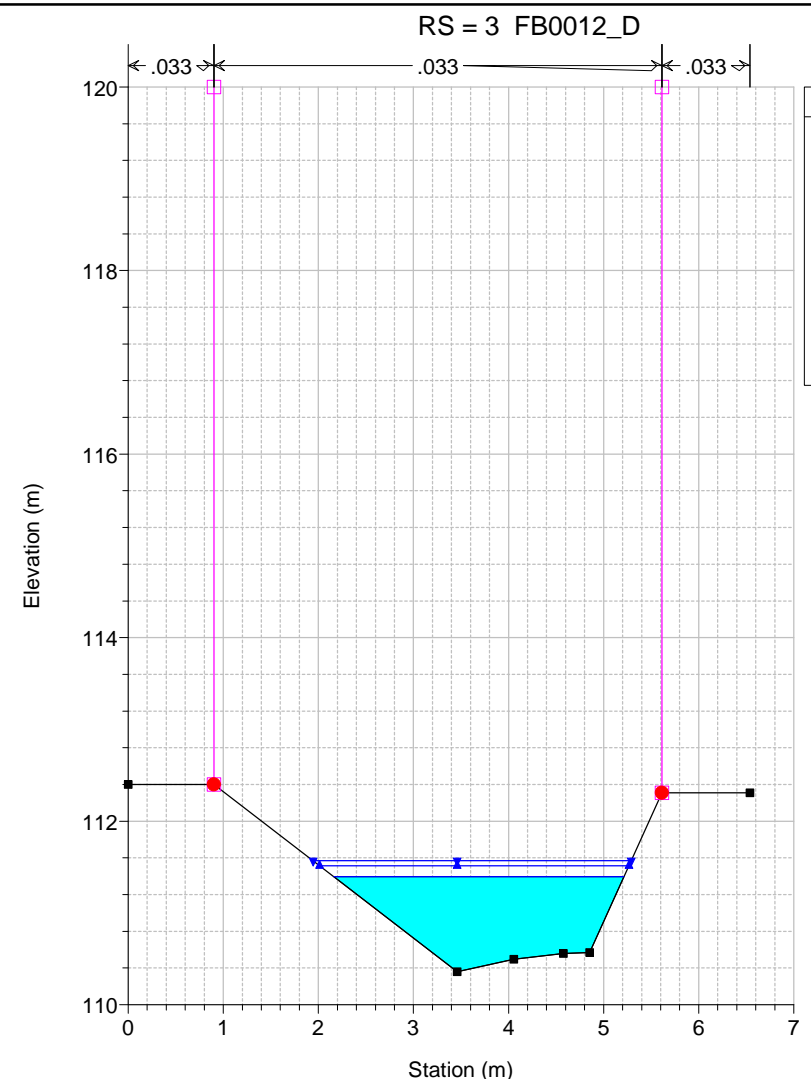
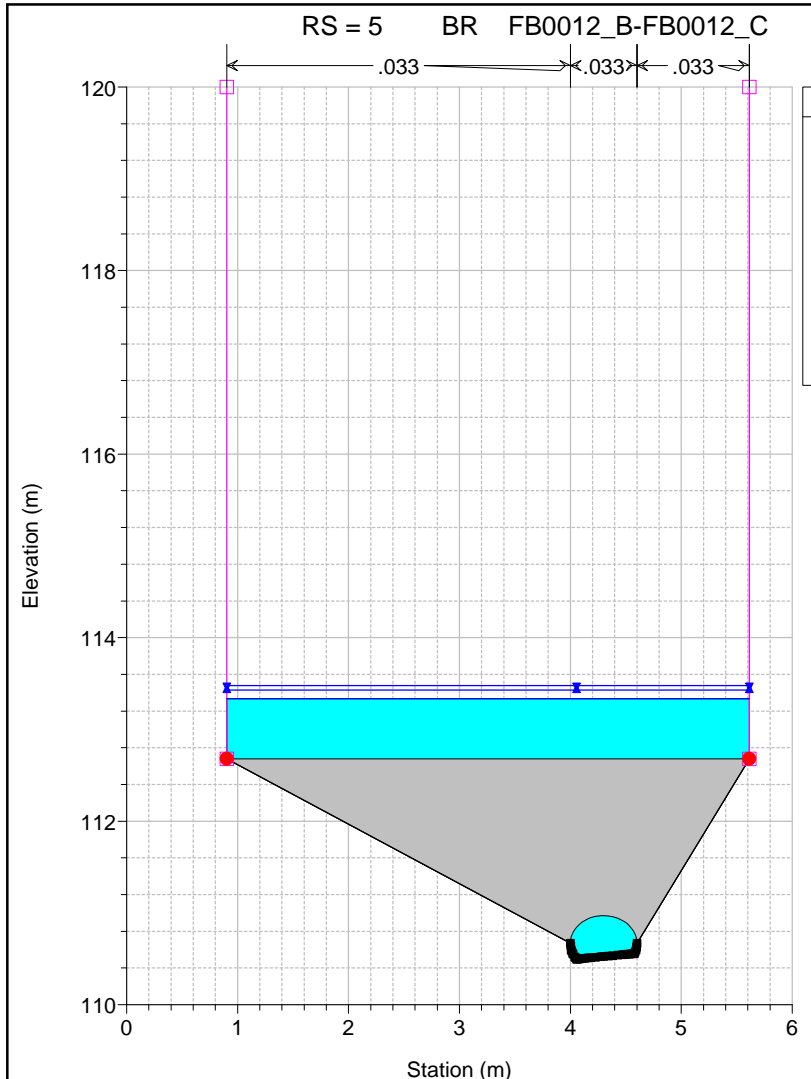

Sezioni fluviali
Fosso Poderino
Tempo di ritorno: 30, 200 e 500 anni

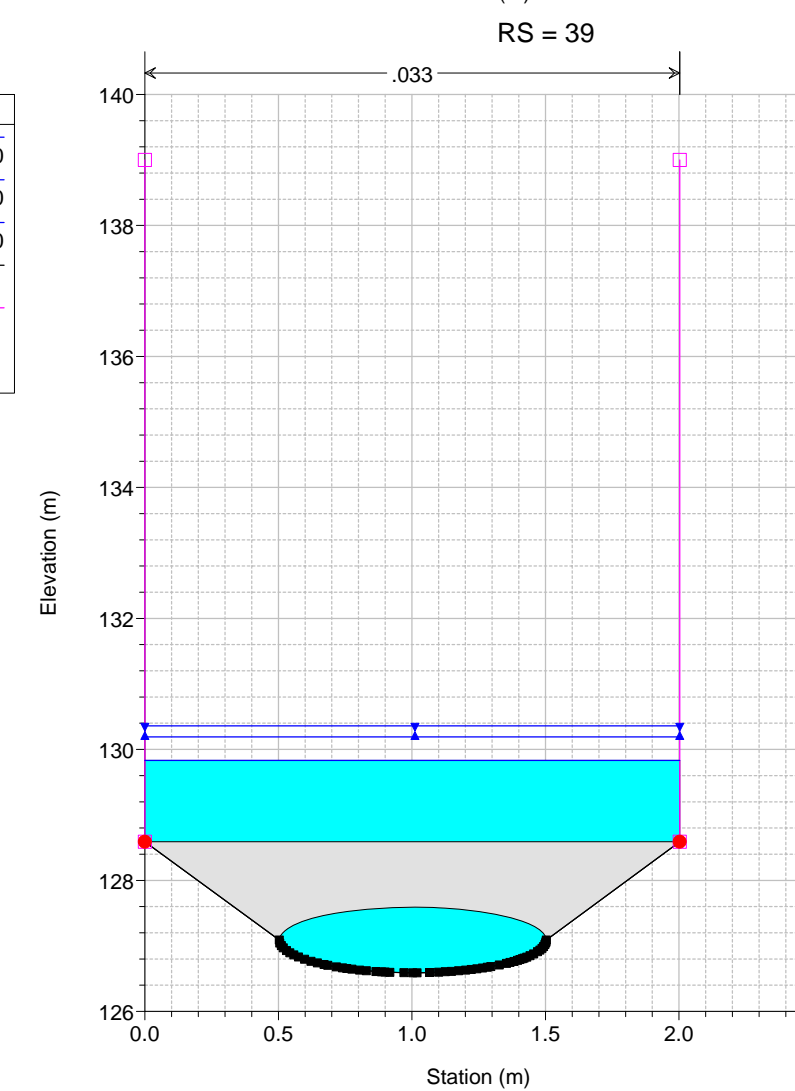
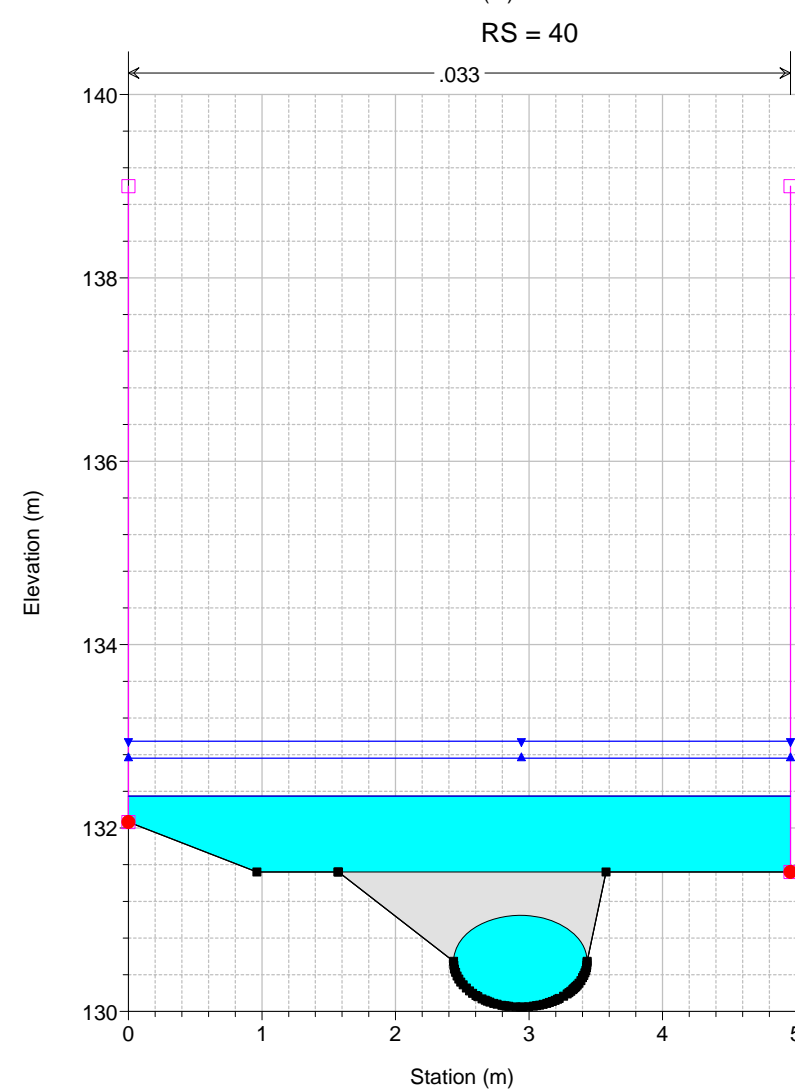
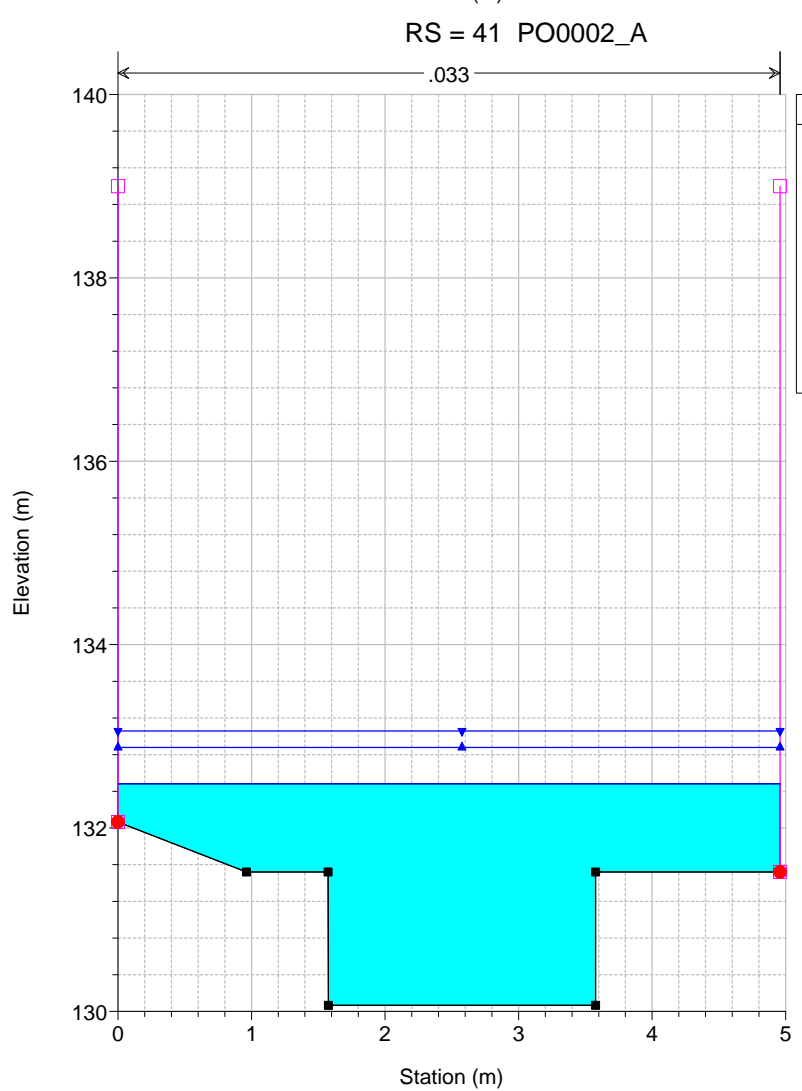
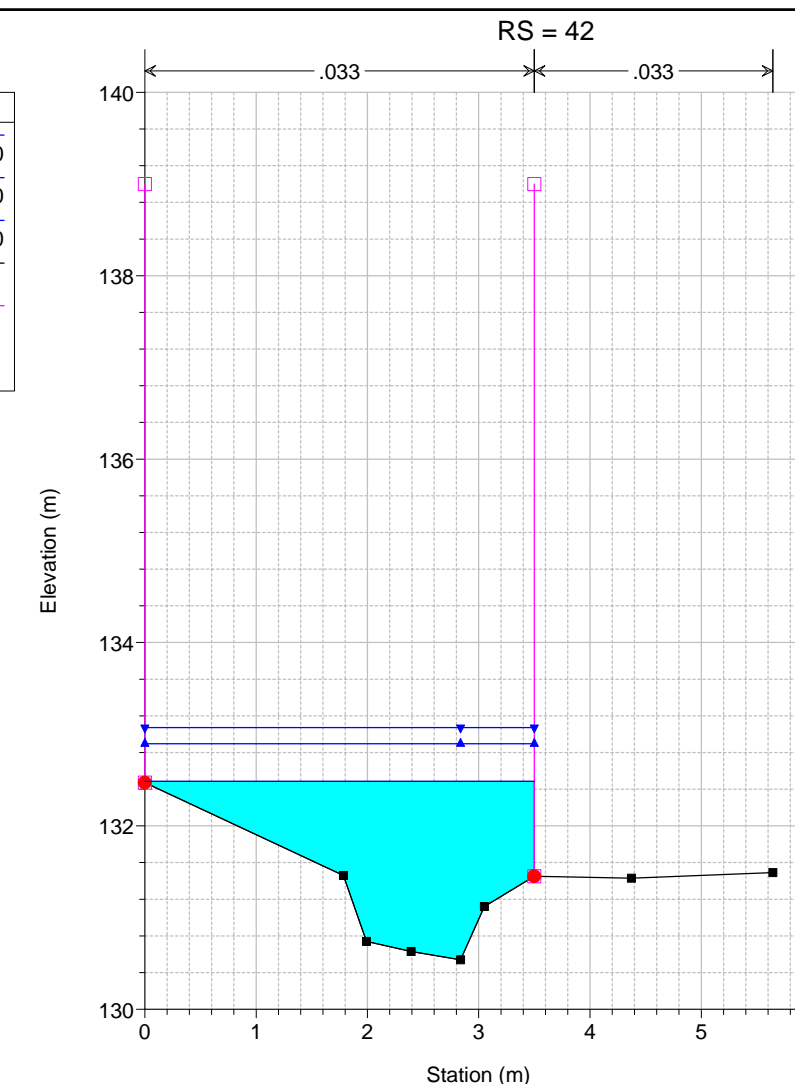
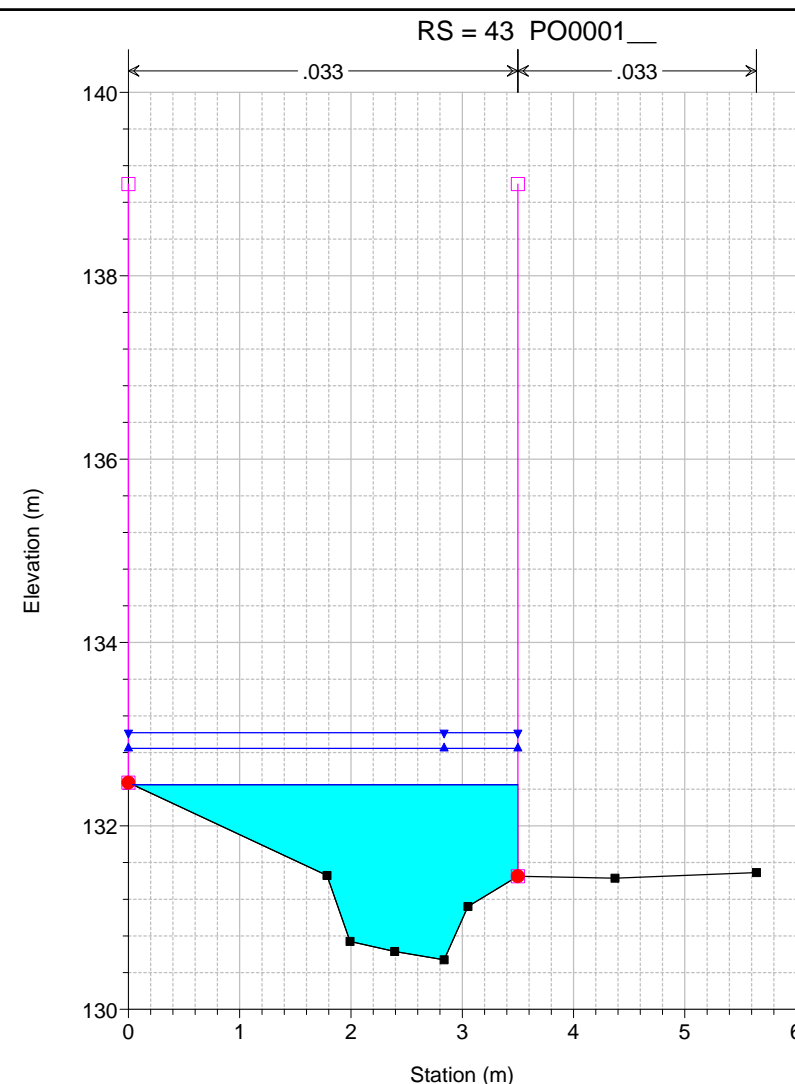
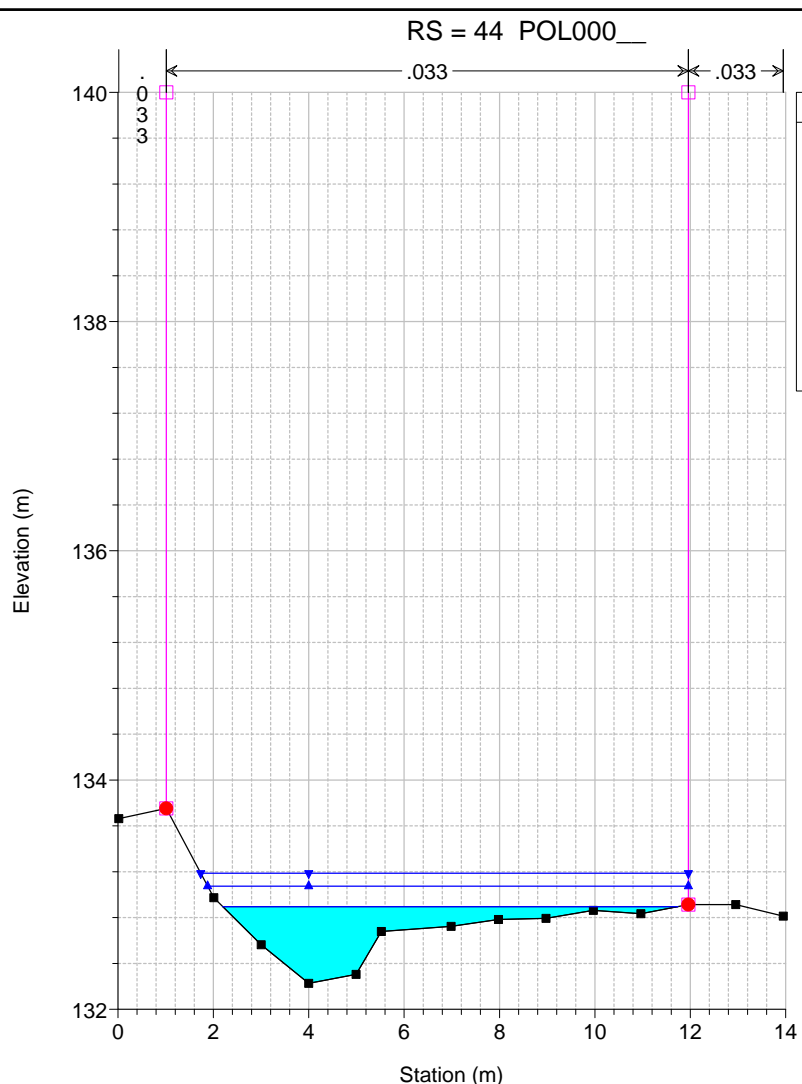

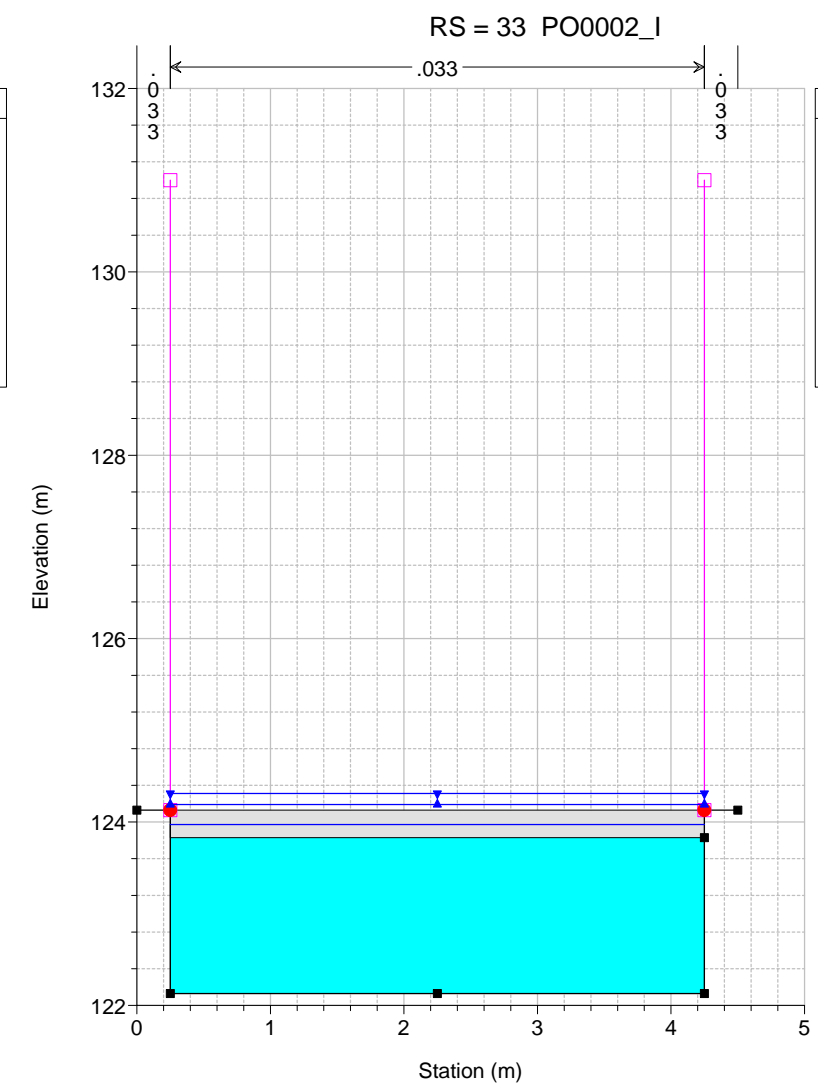
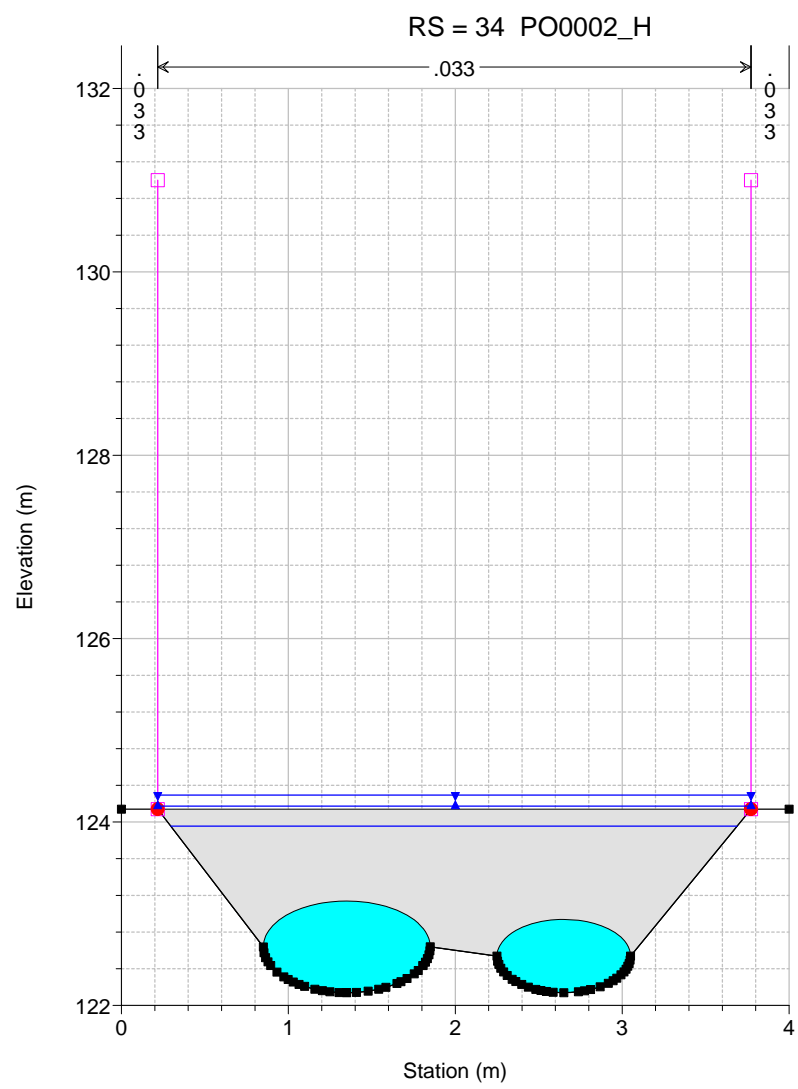
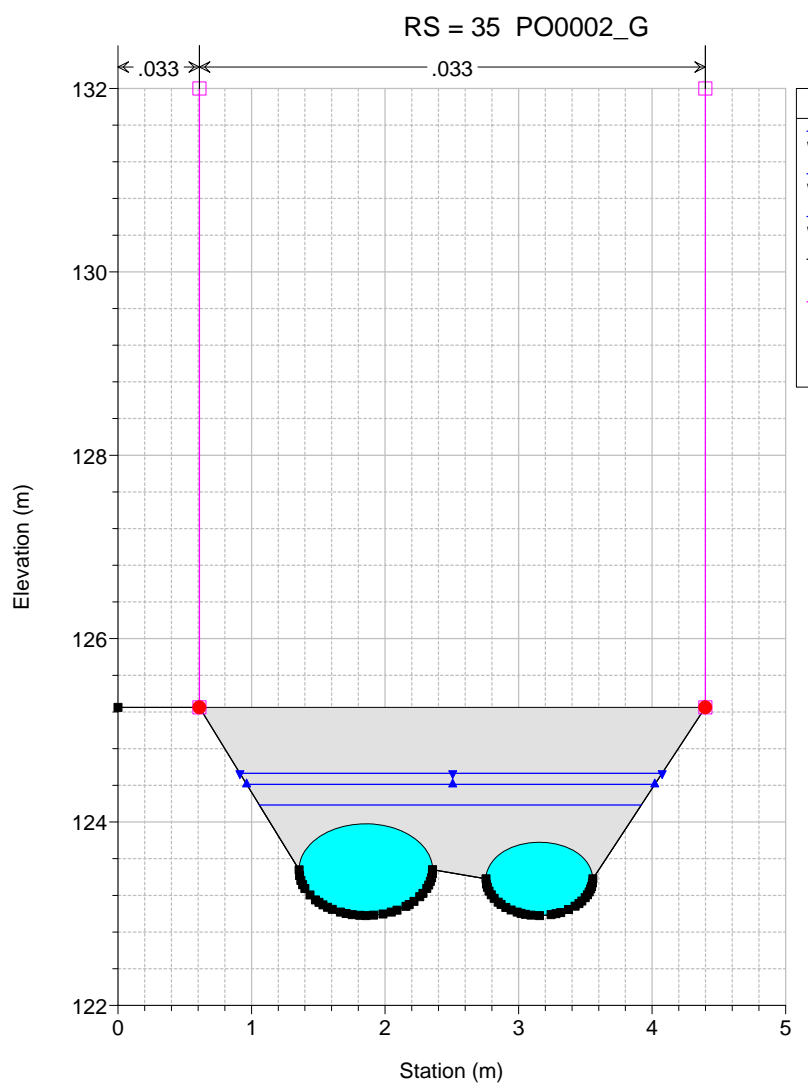
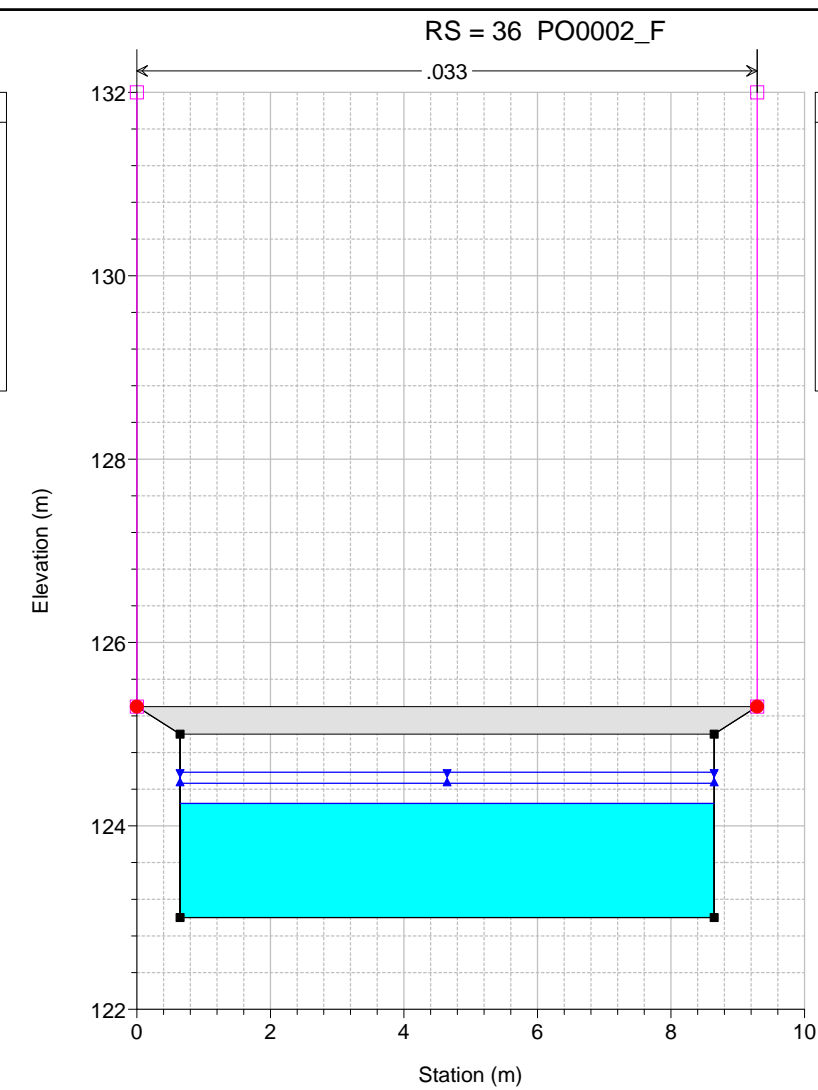
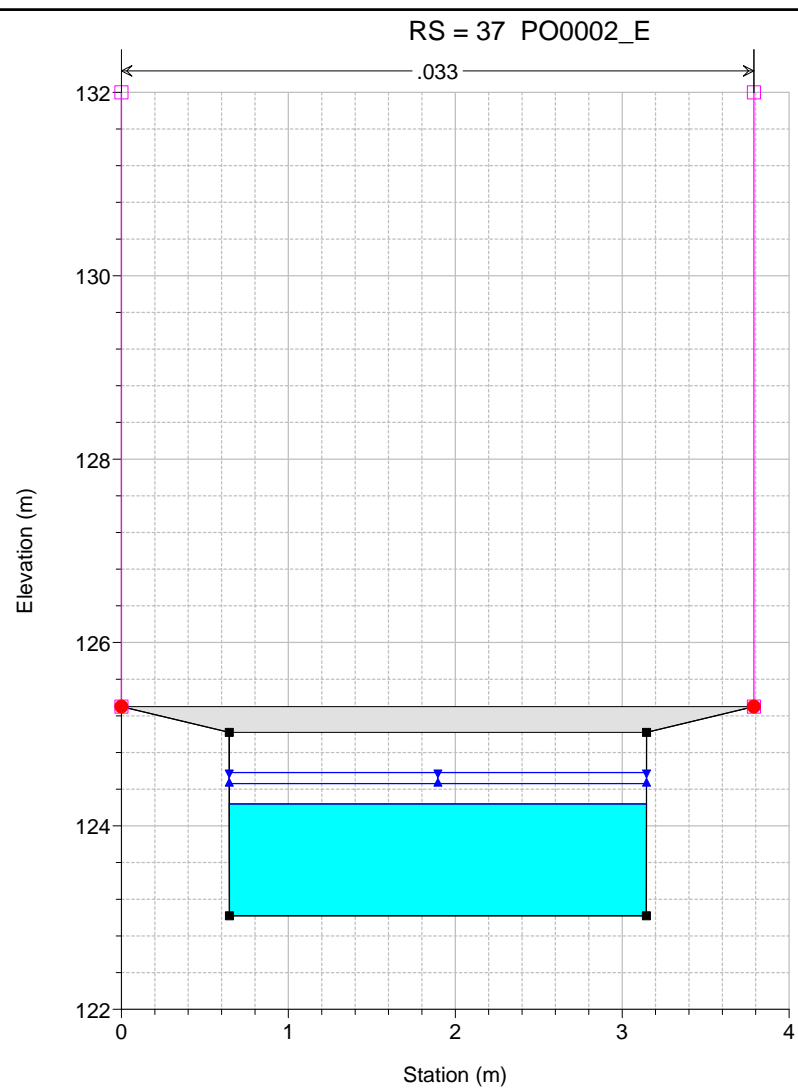
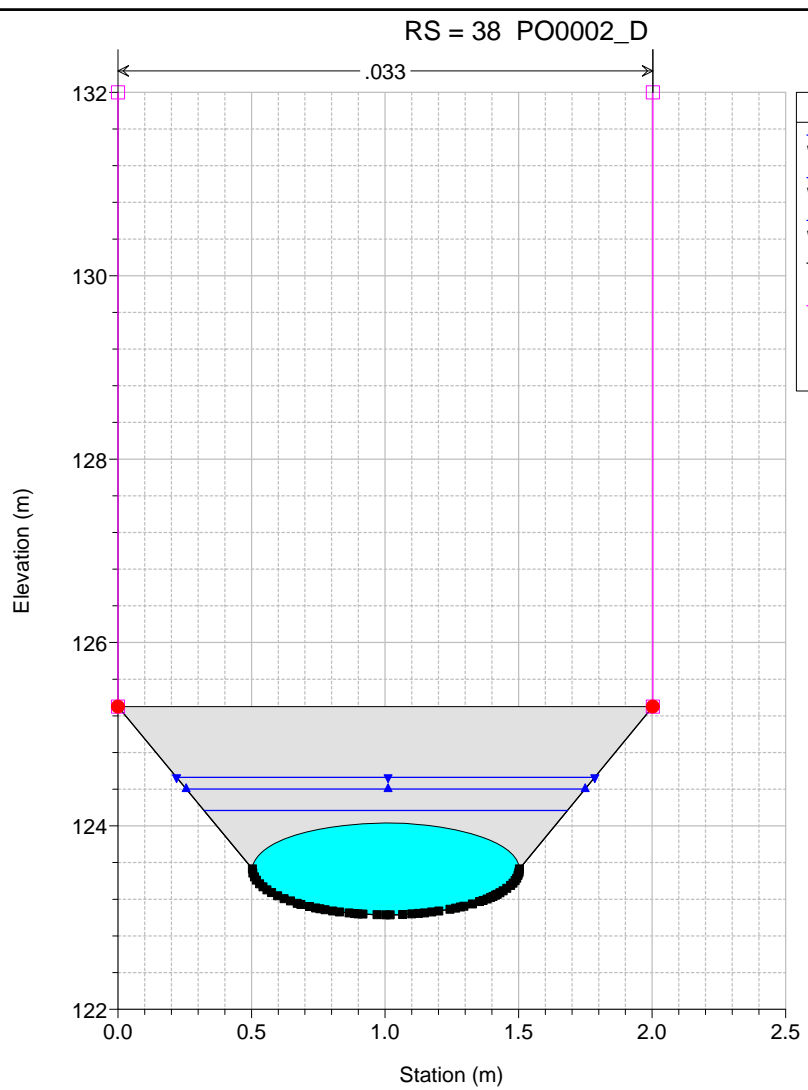

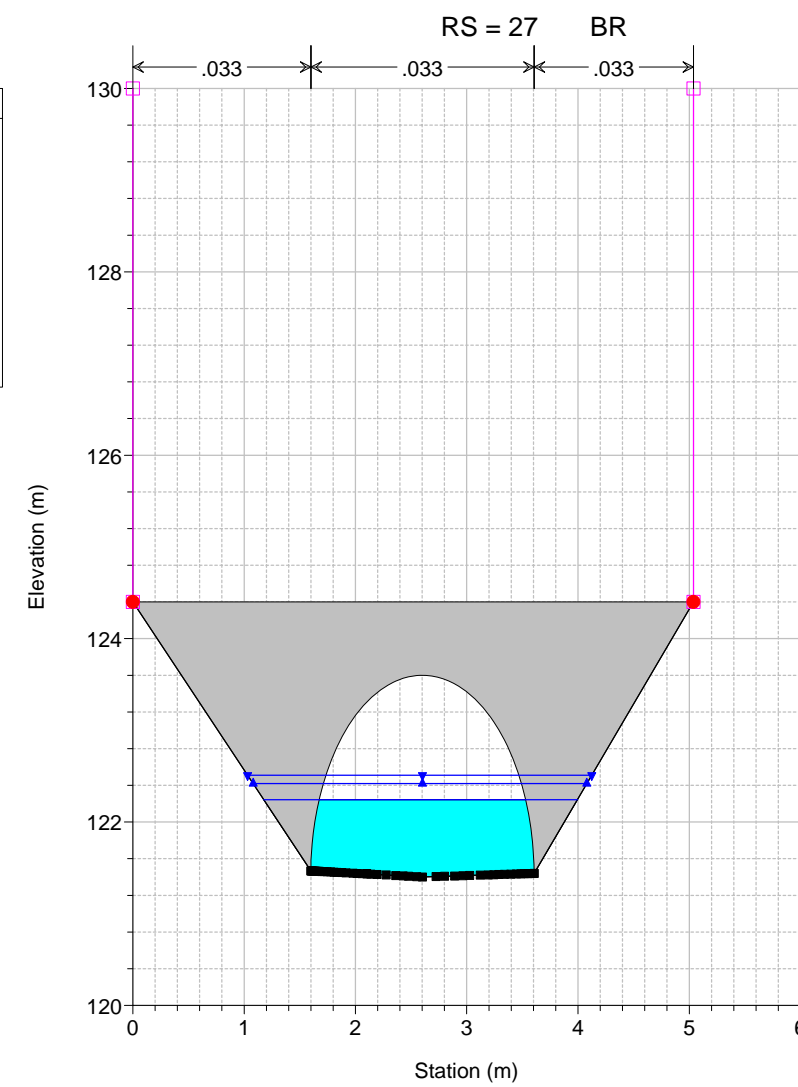
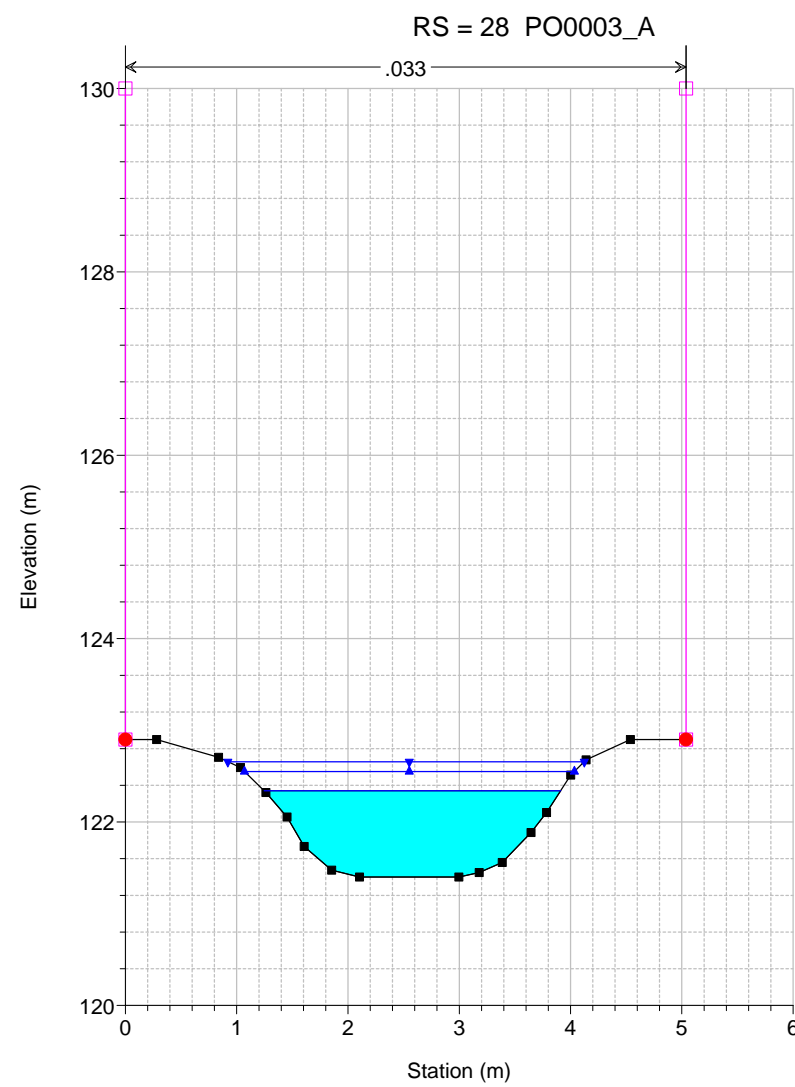
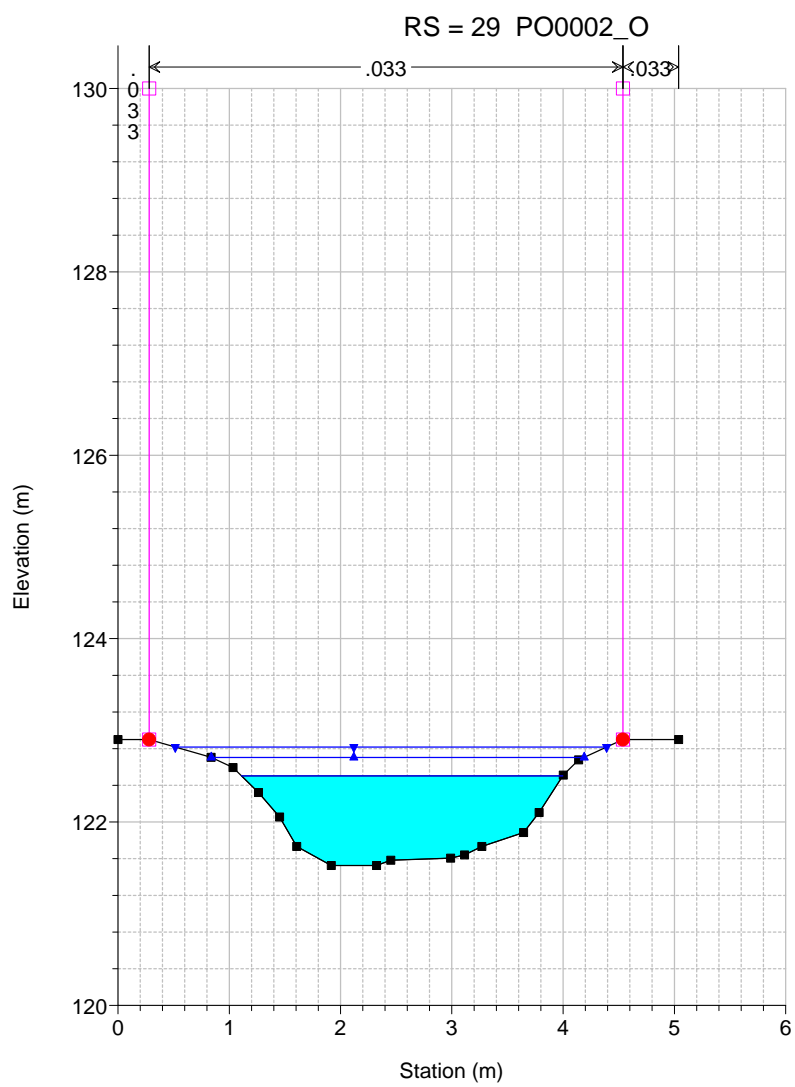
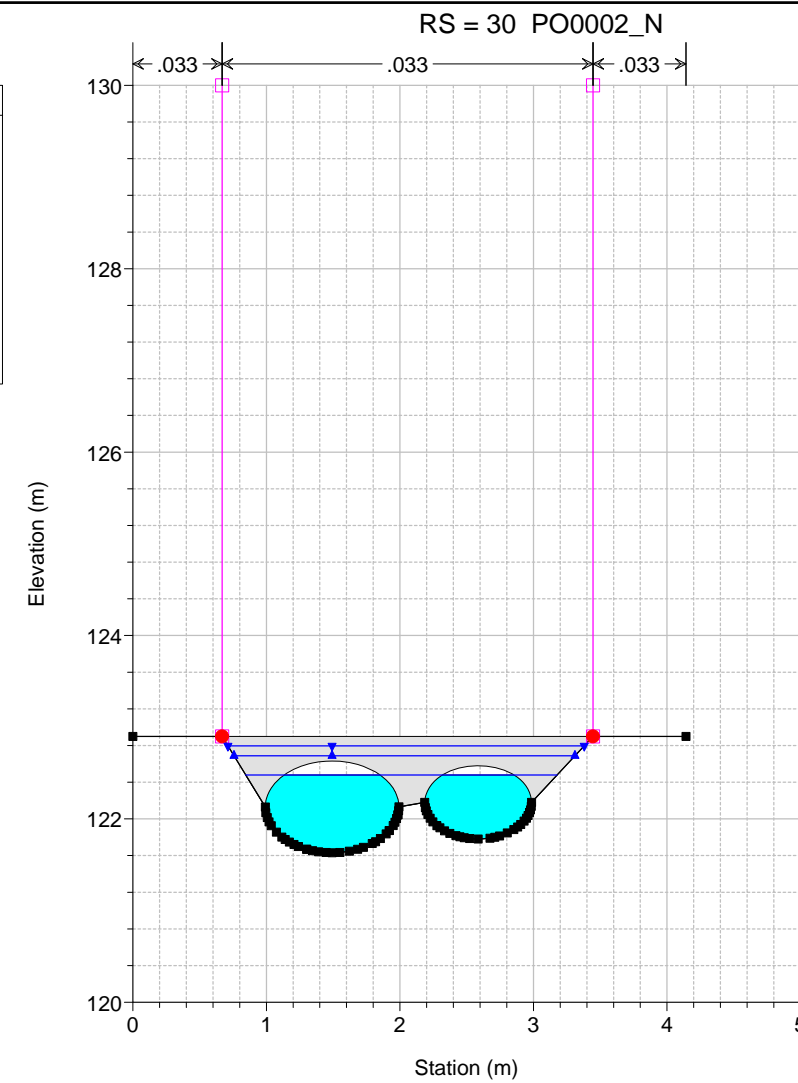
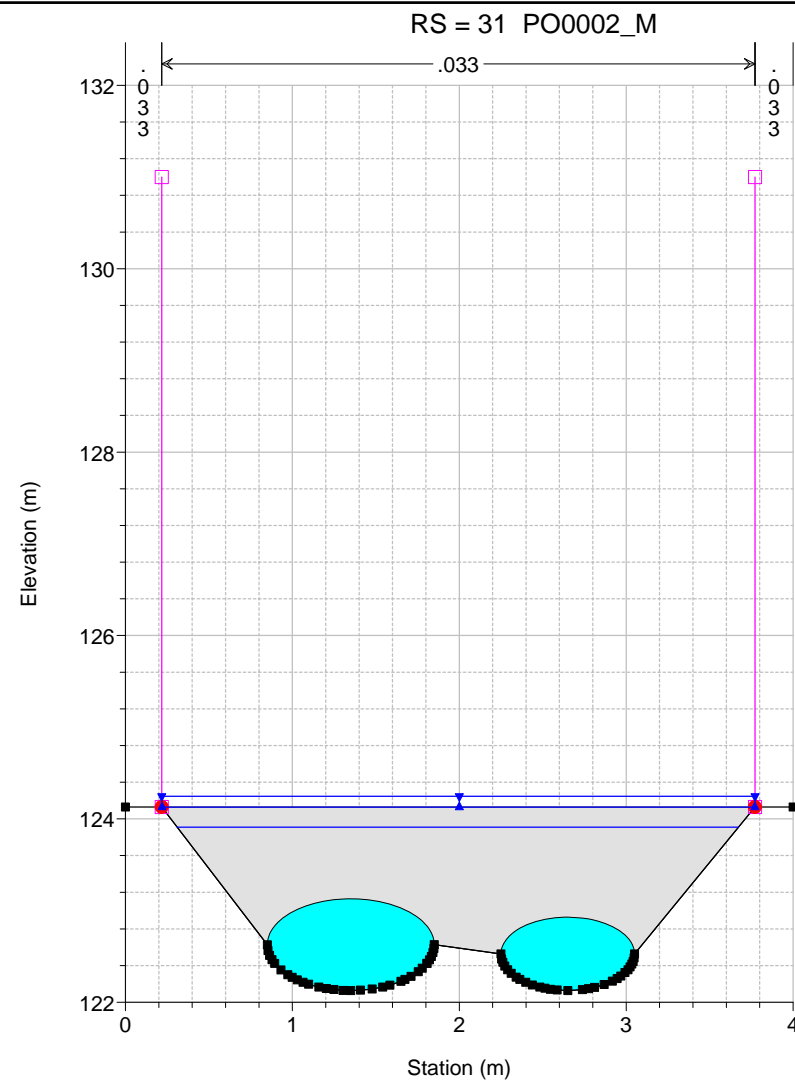
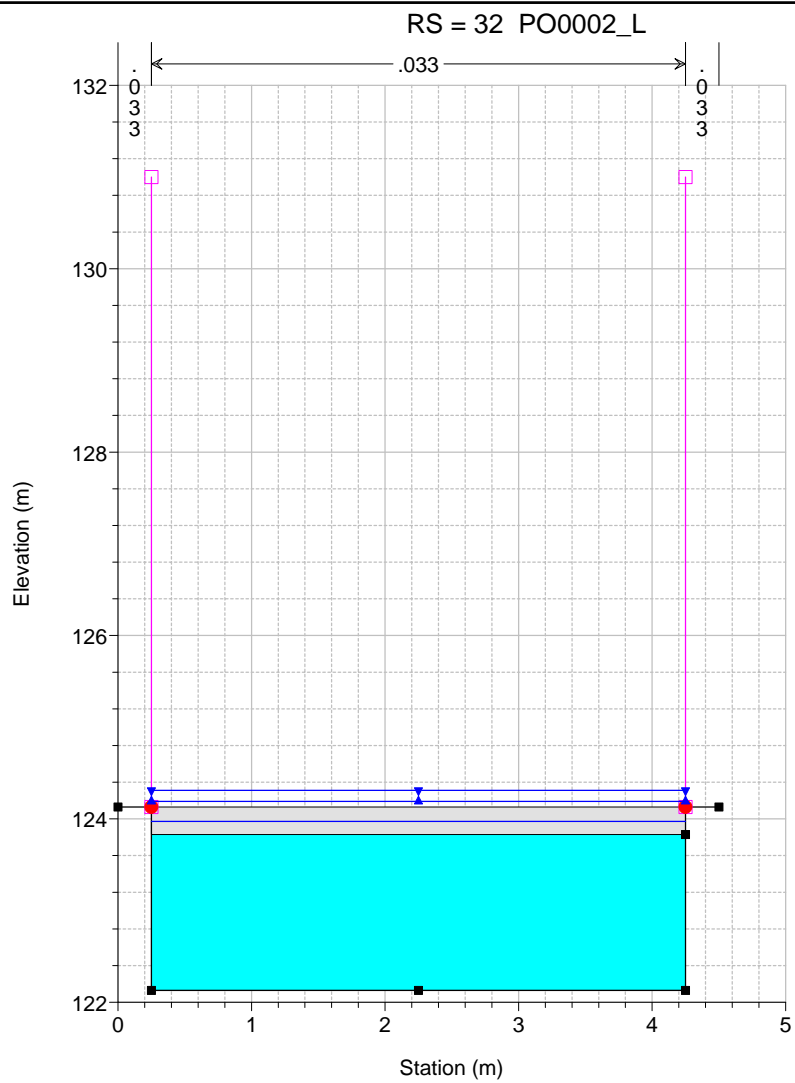

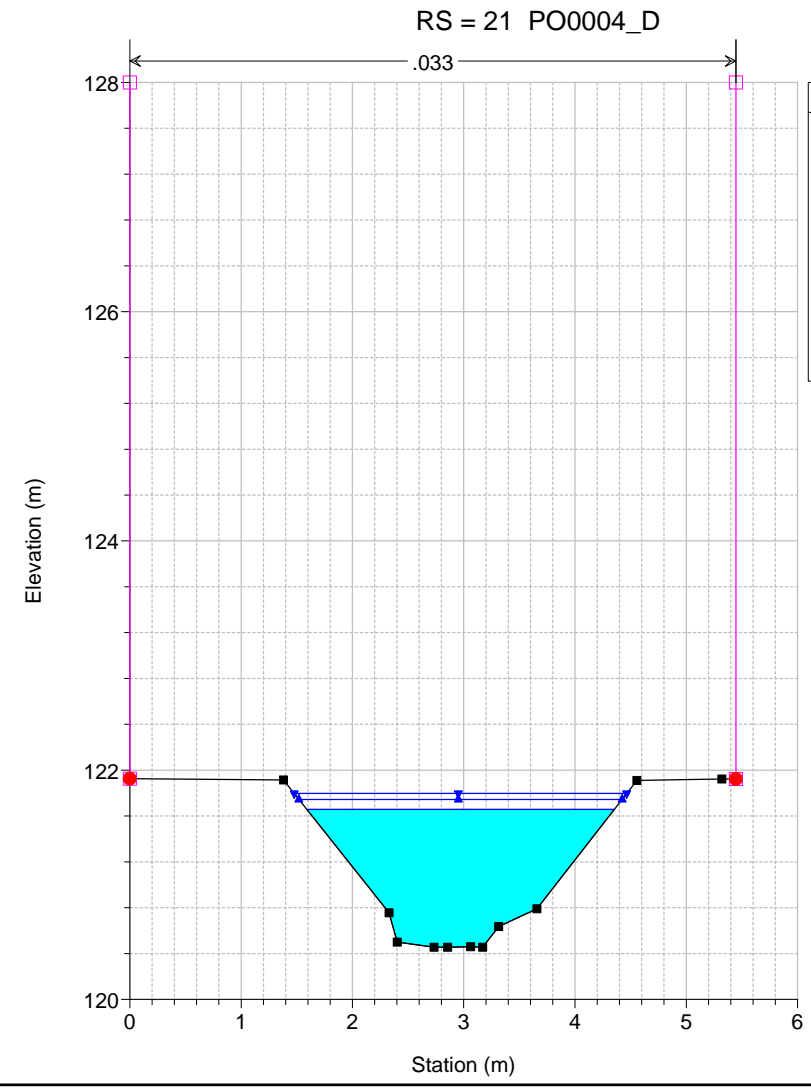
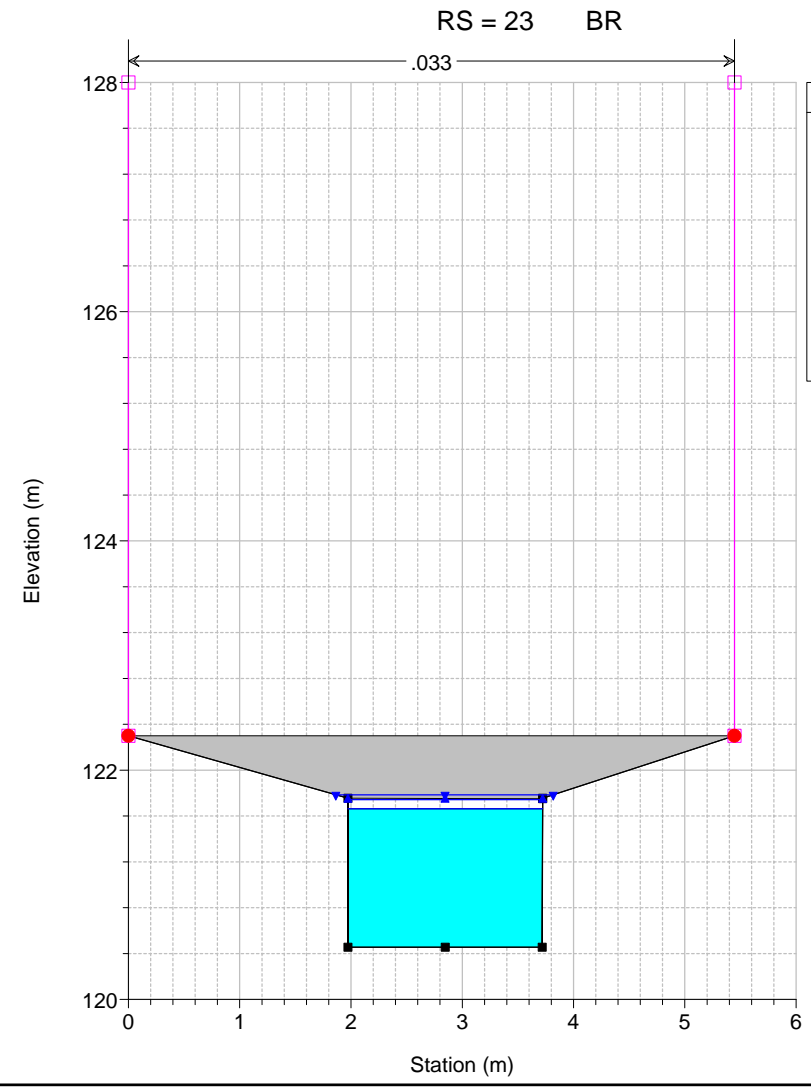
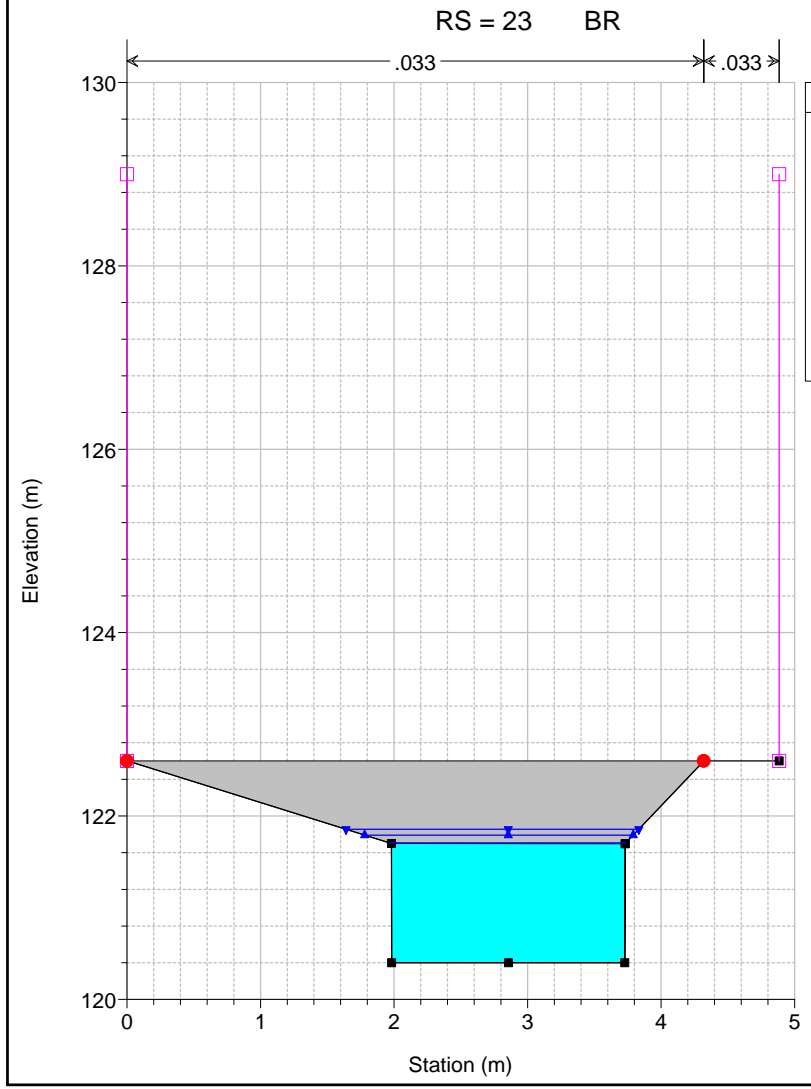
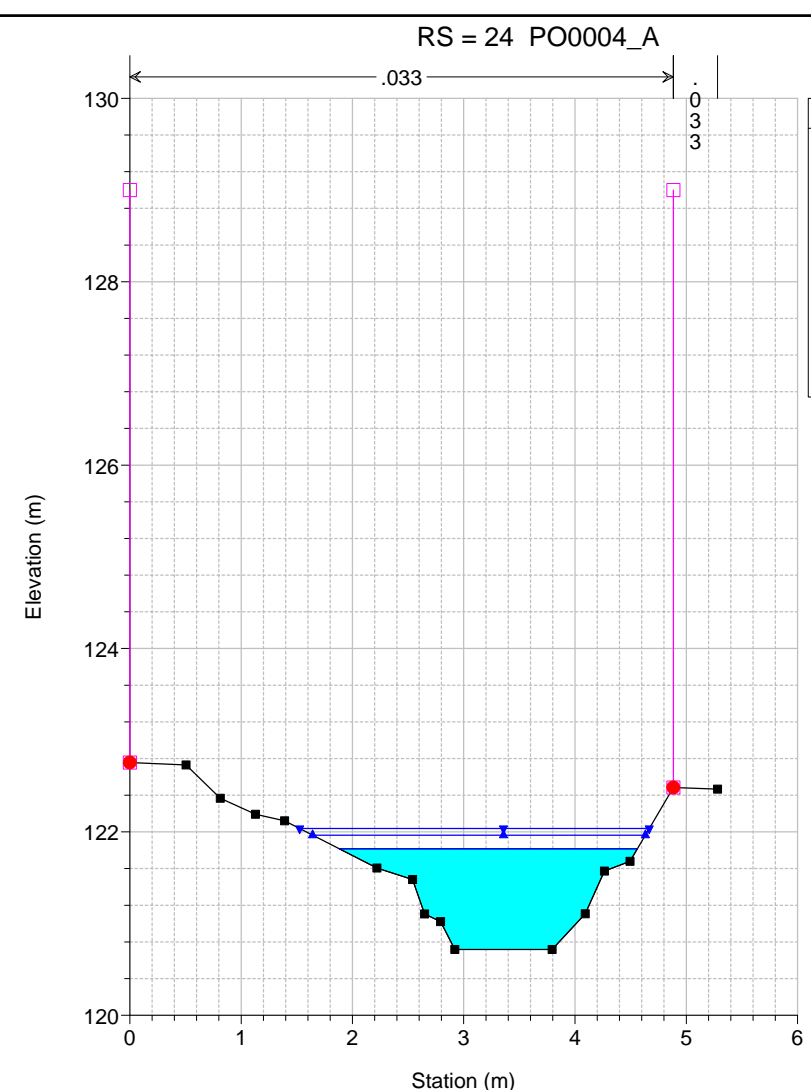
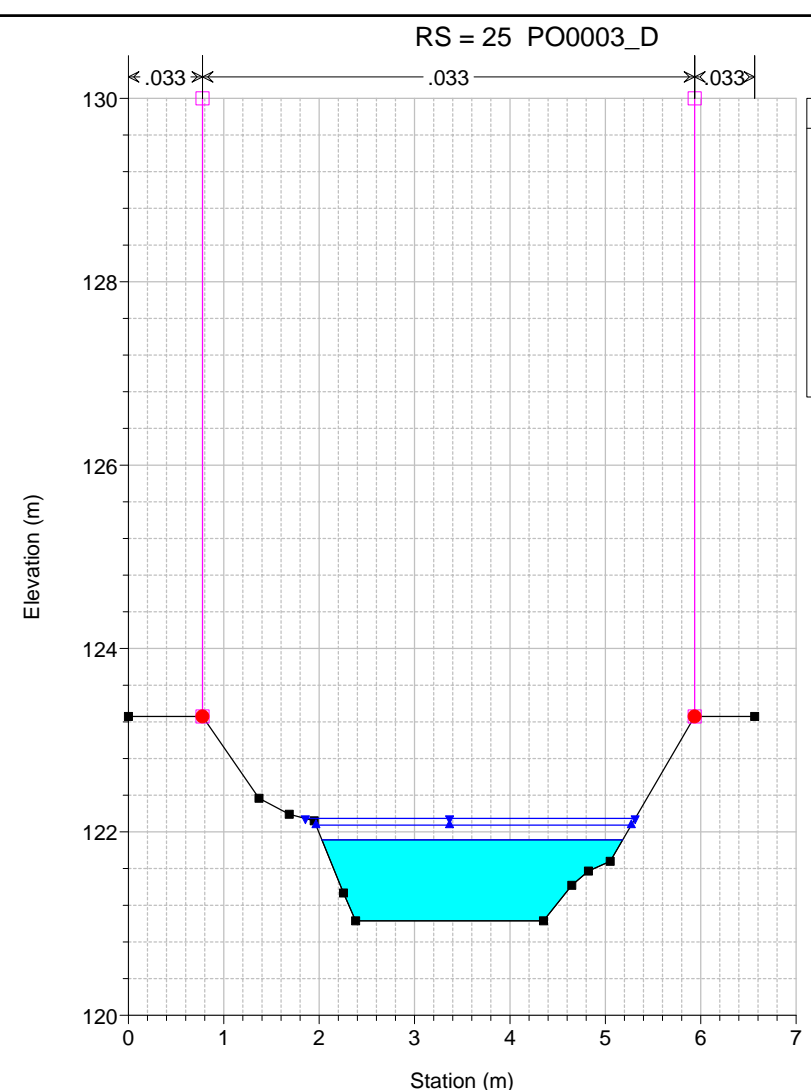
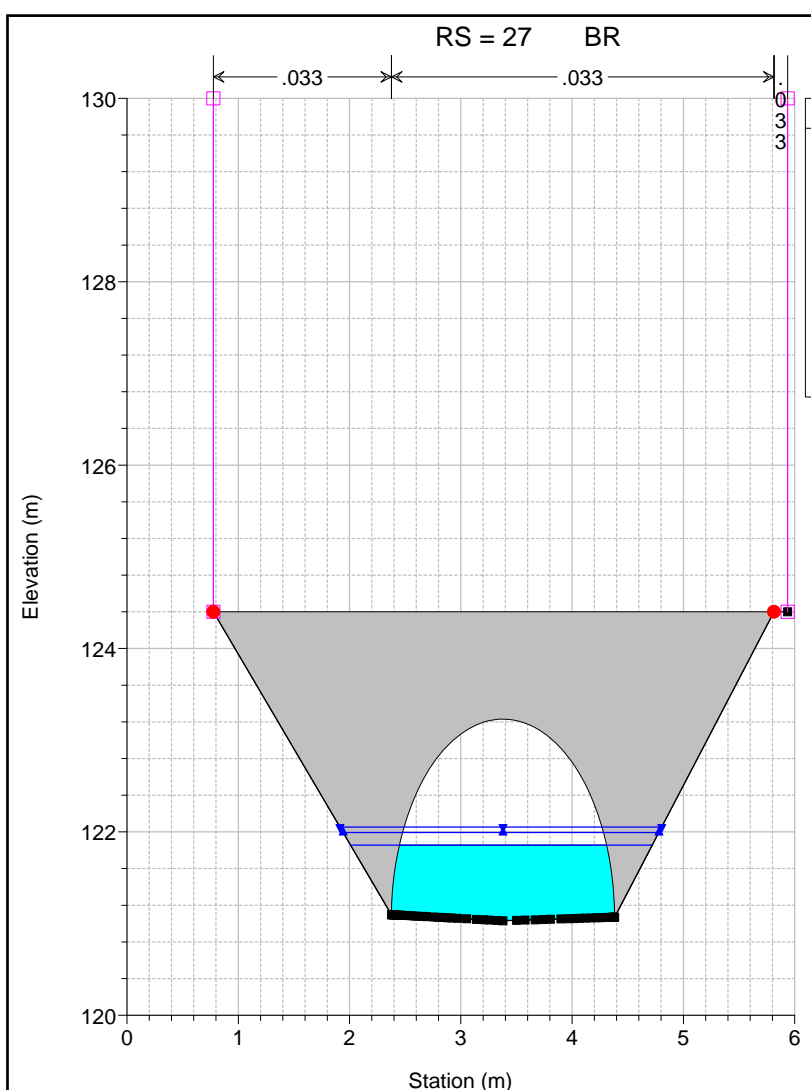

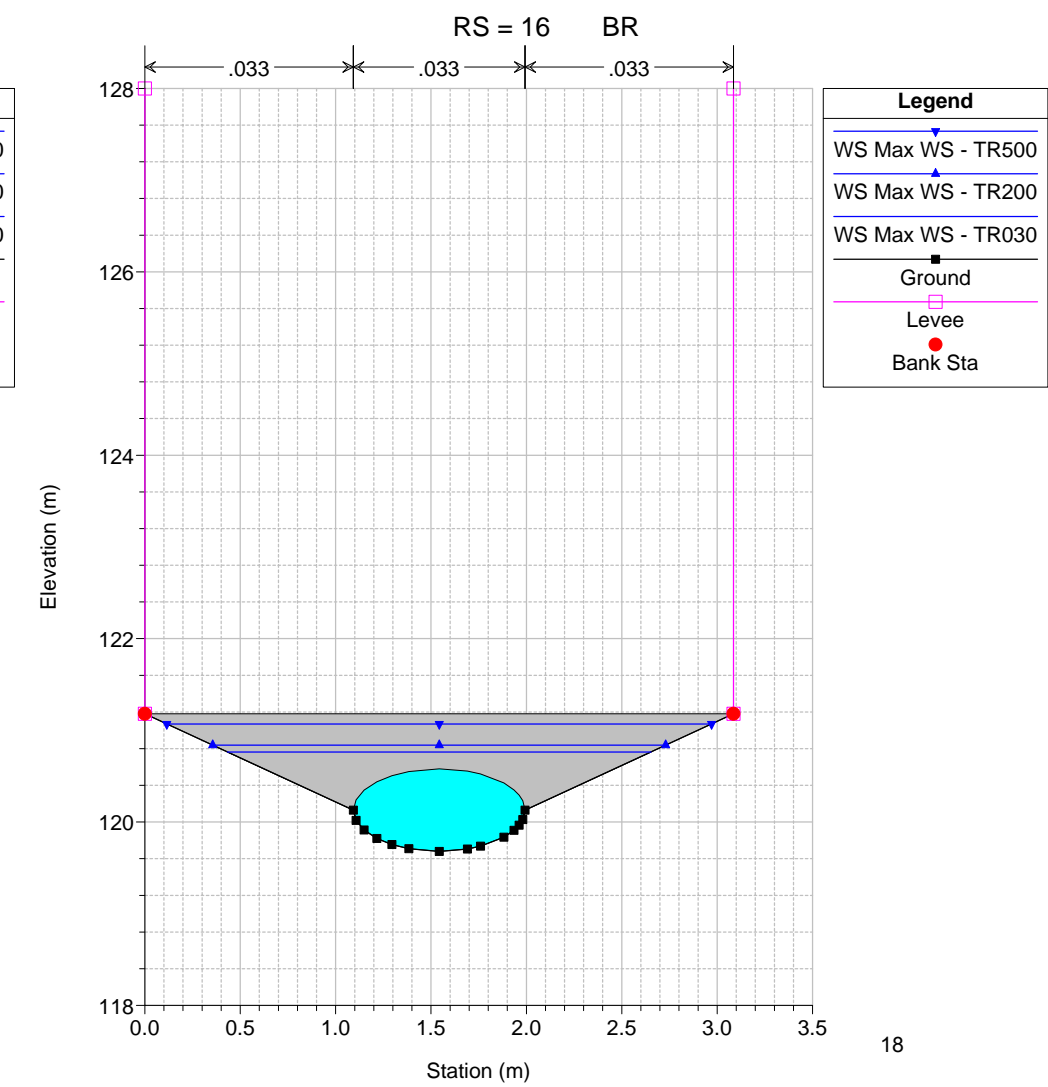
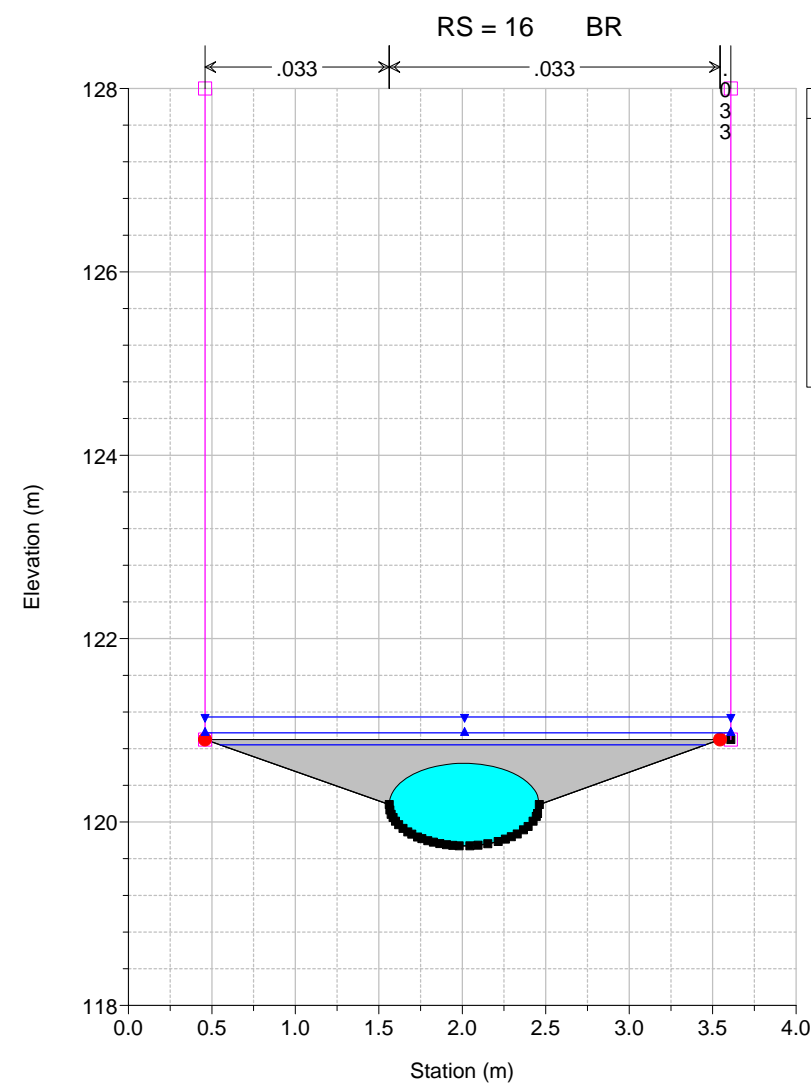
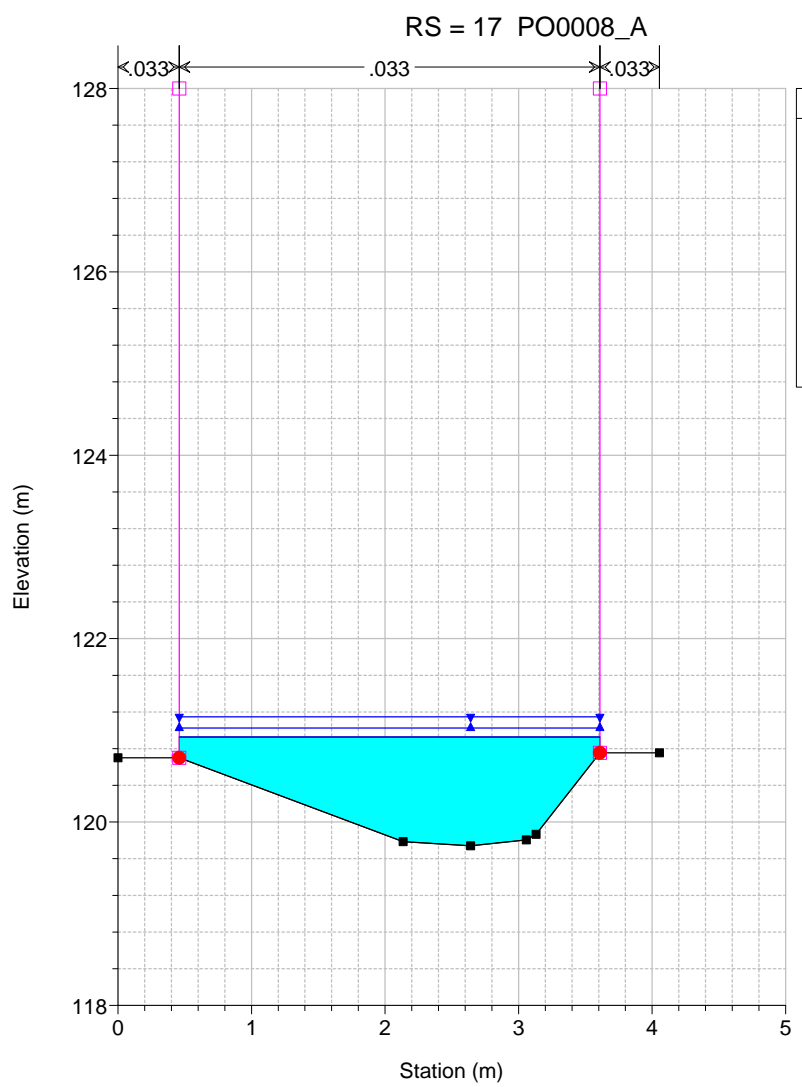
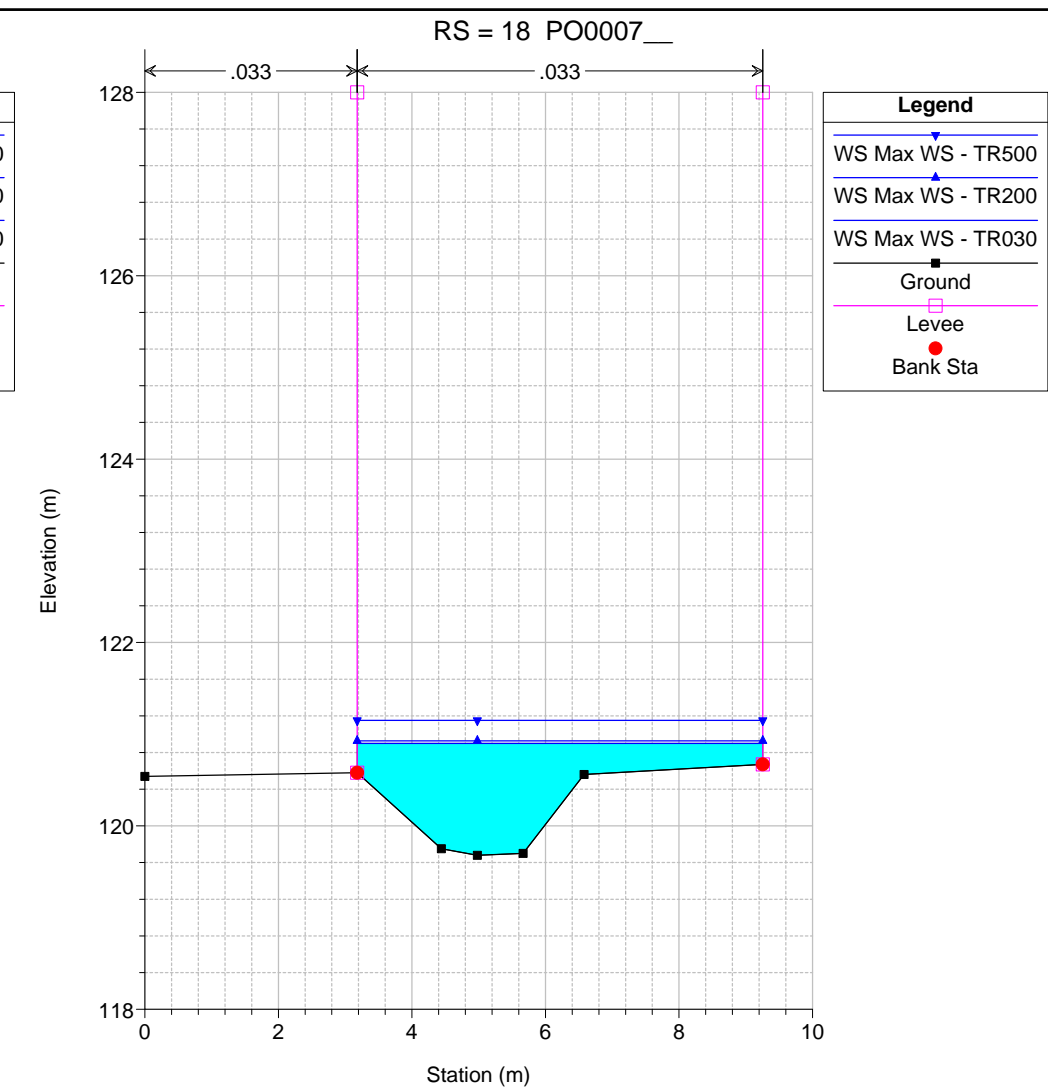
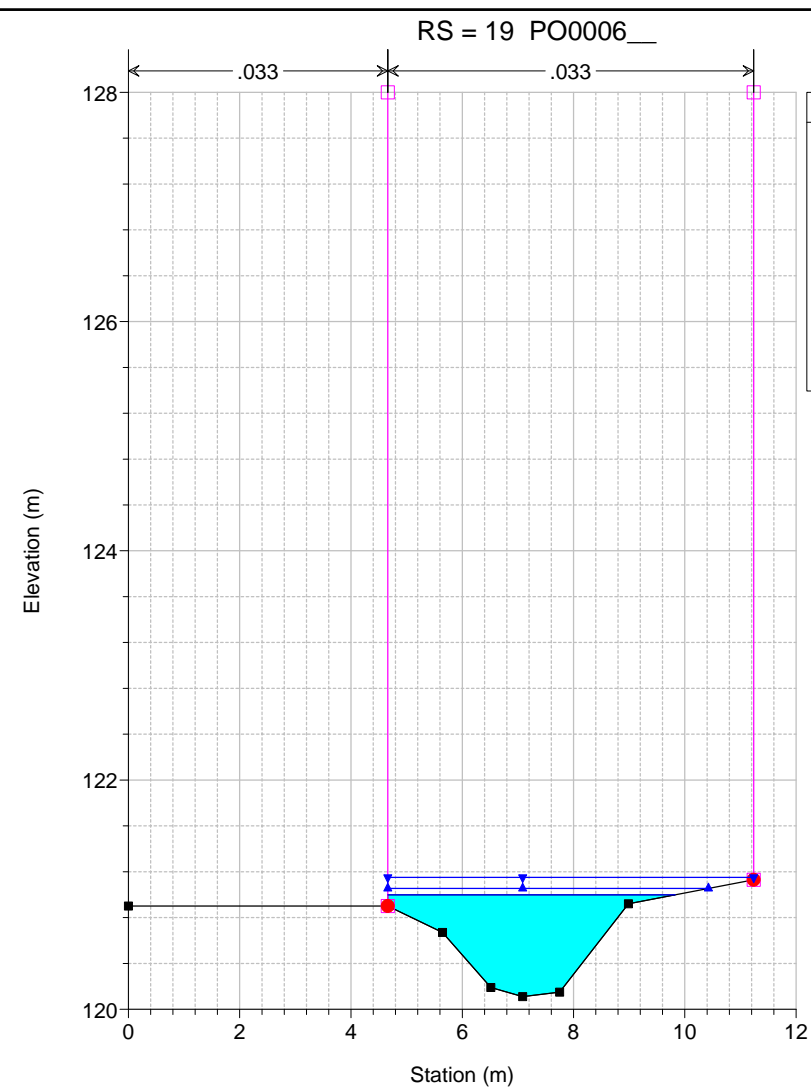
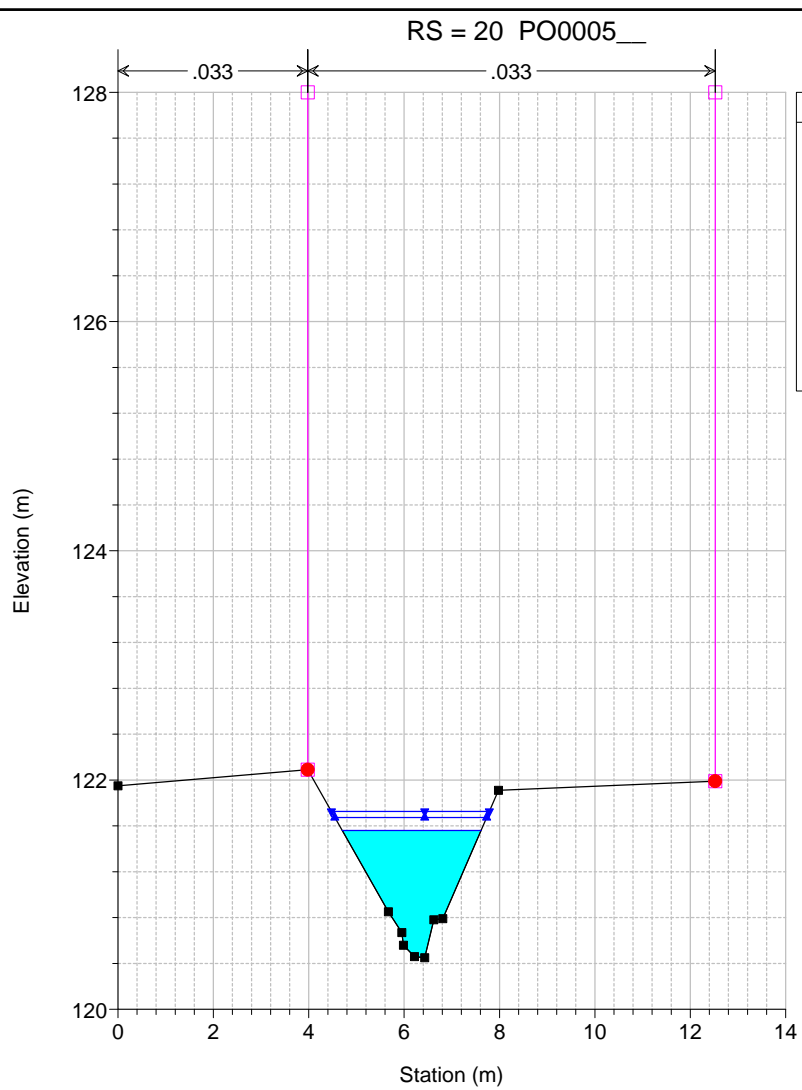

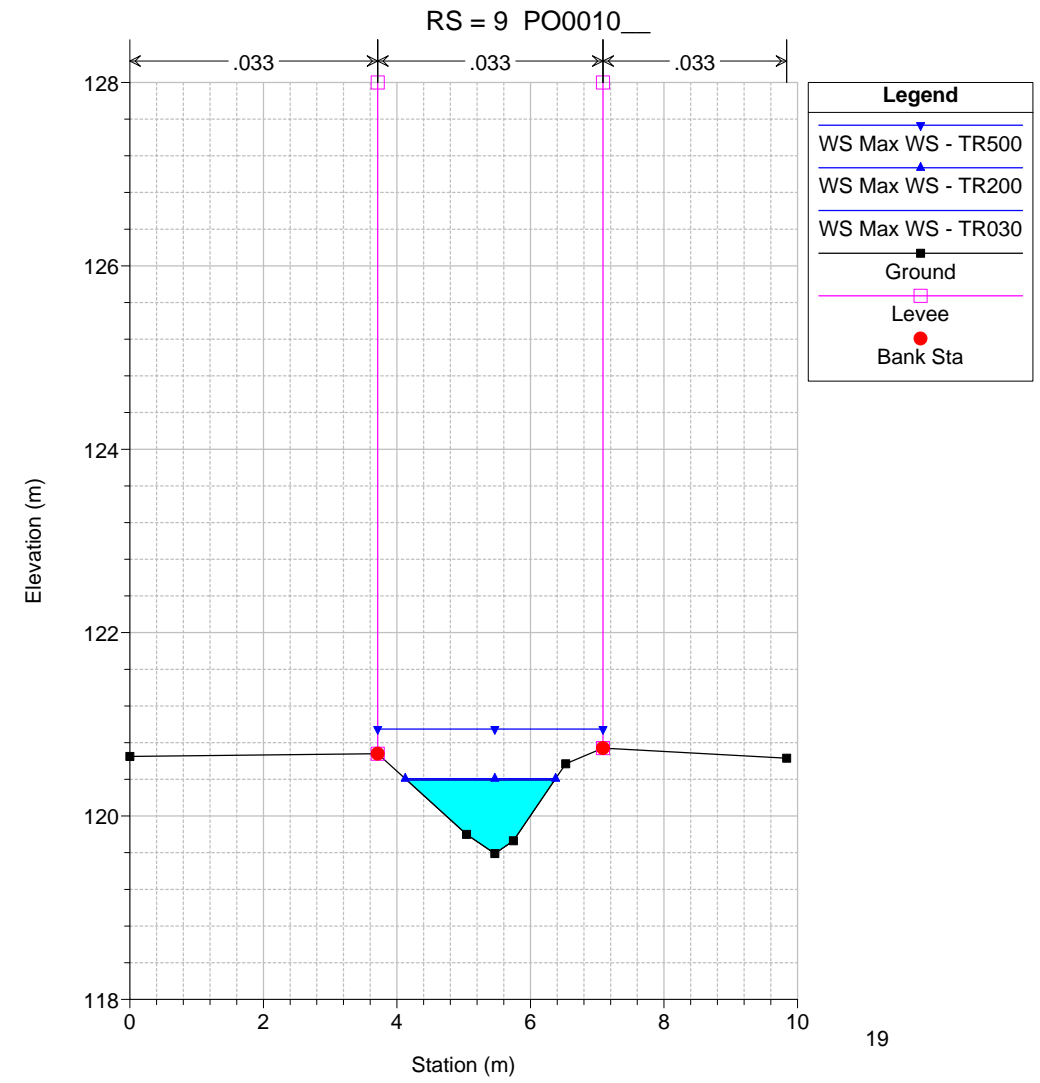
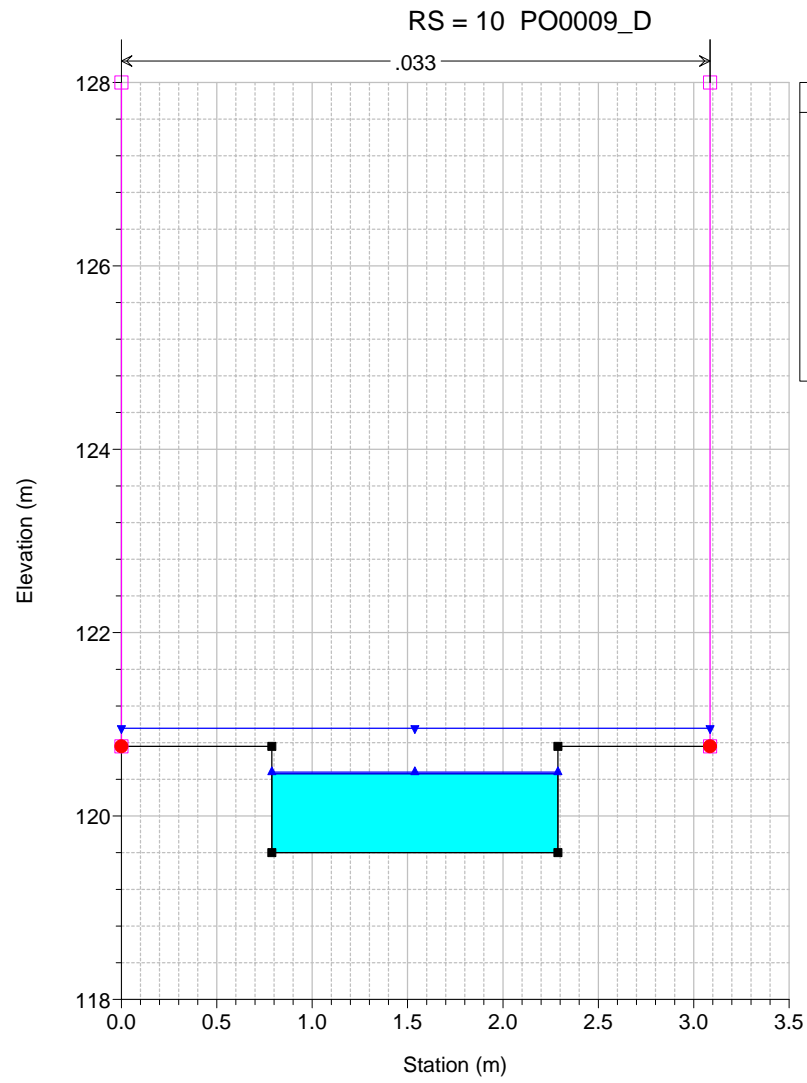
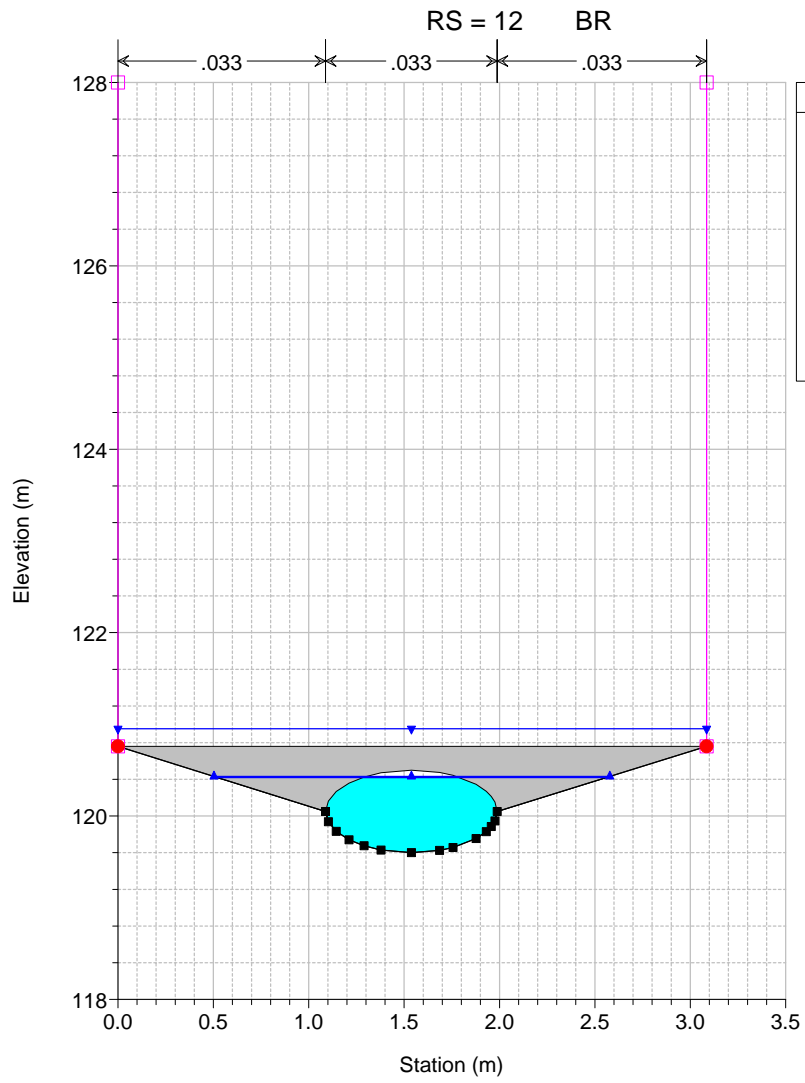
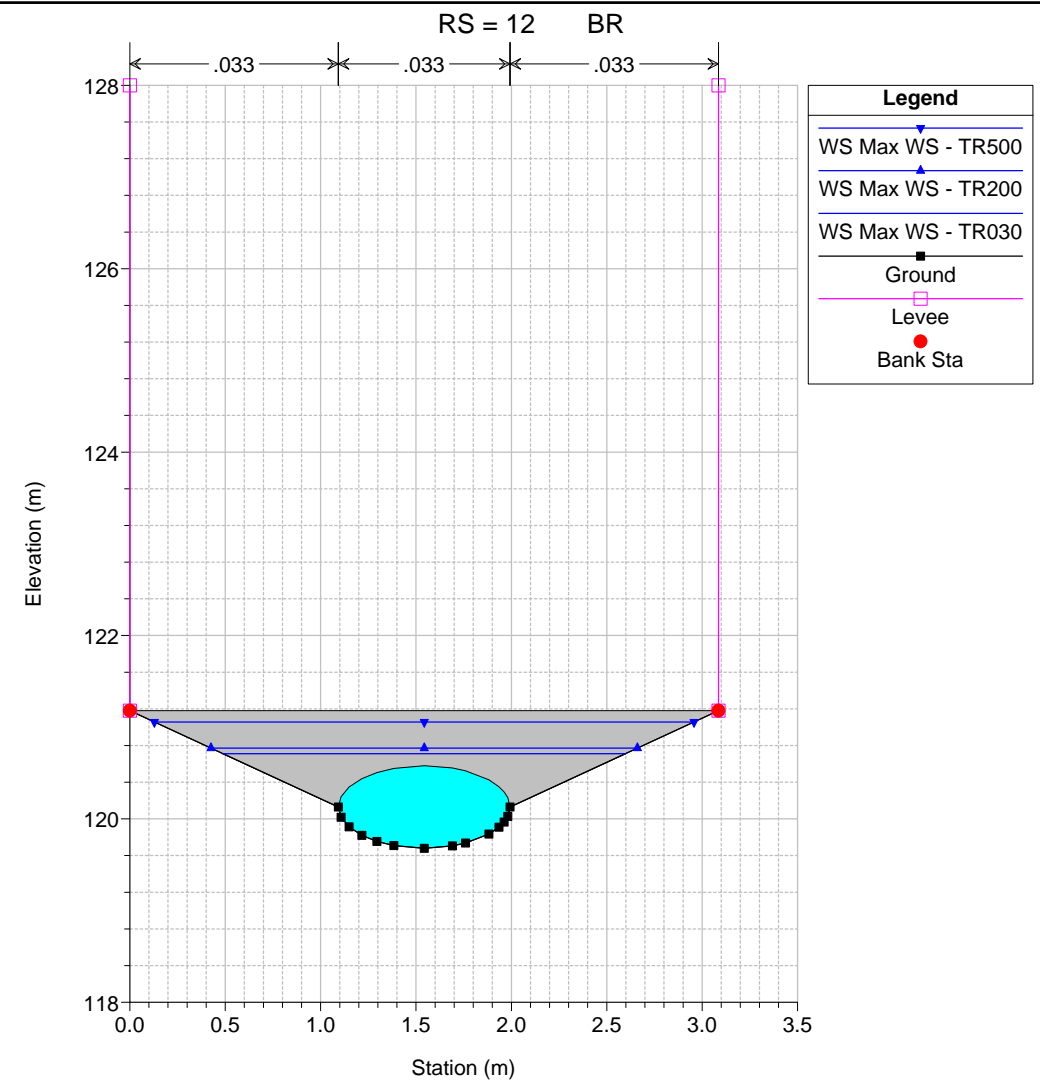
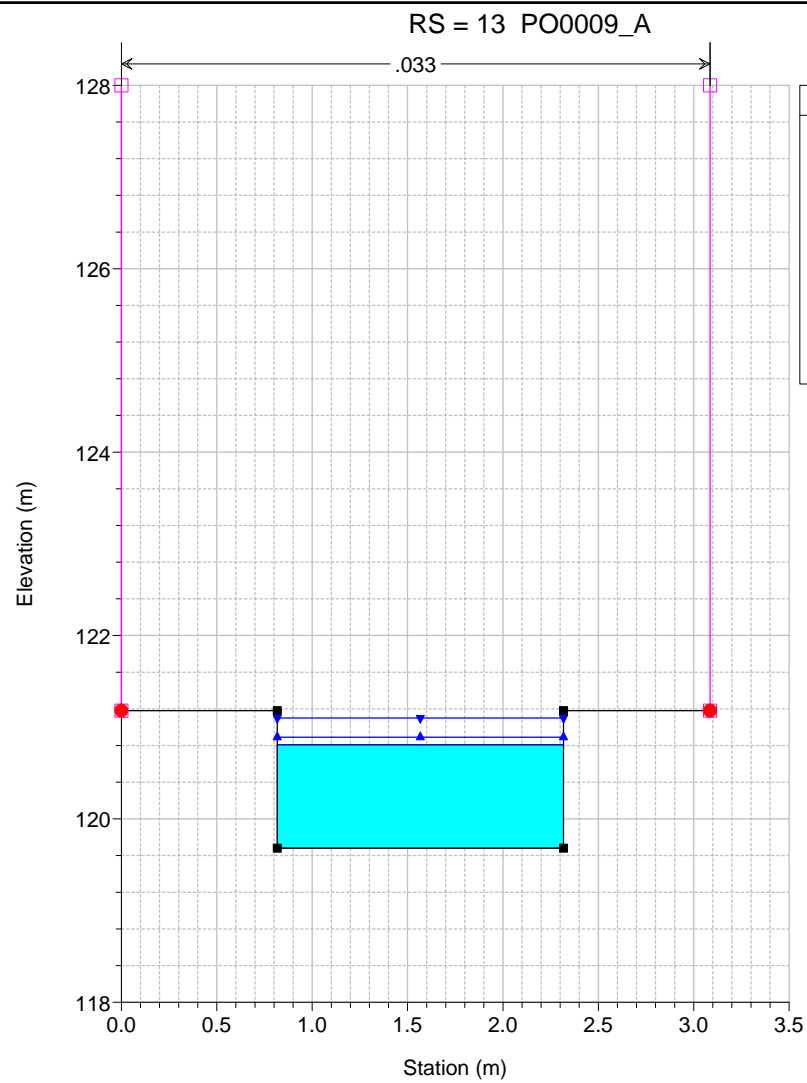
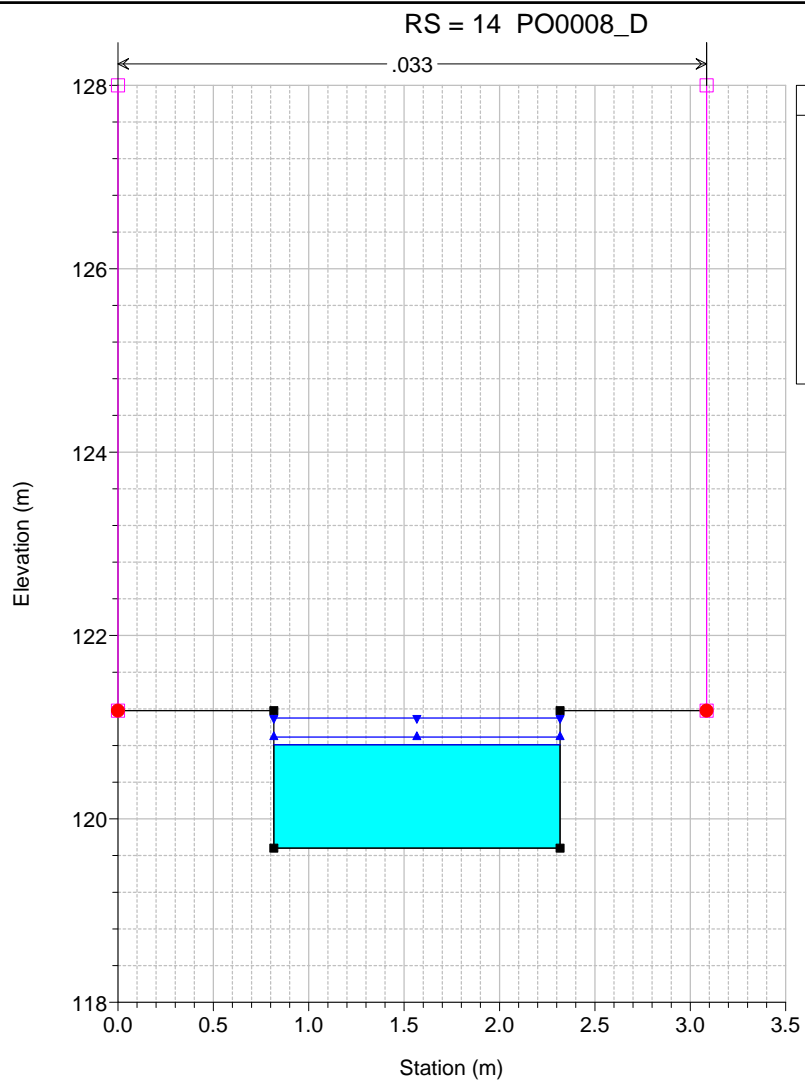

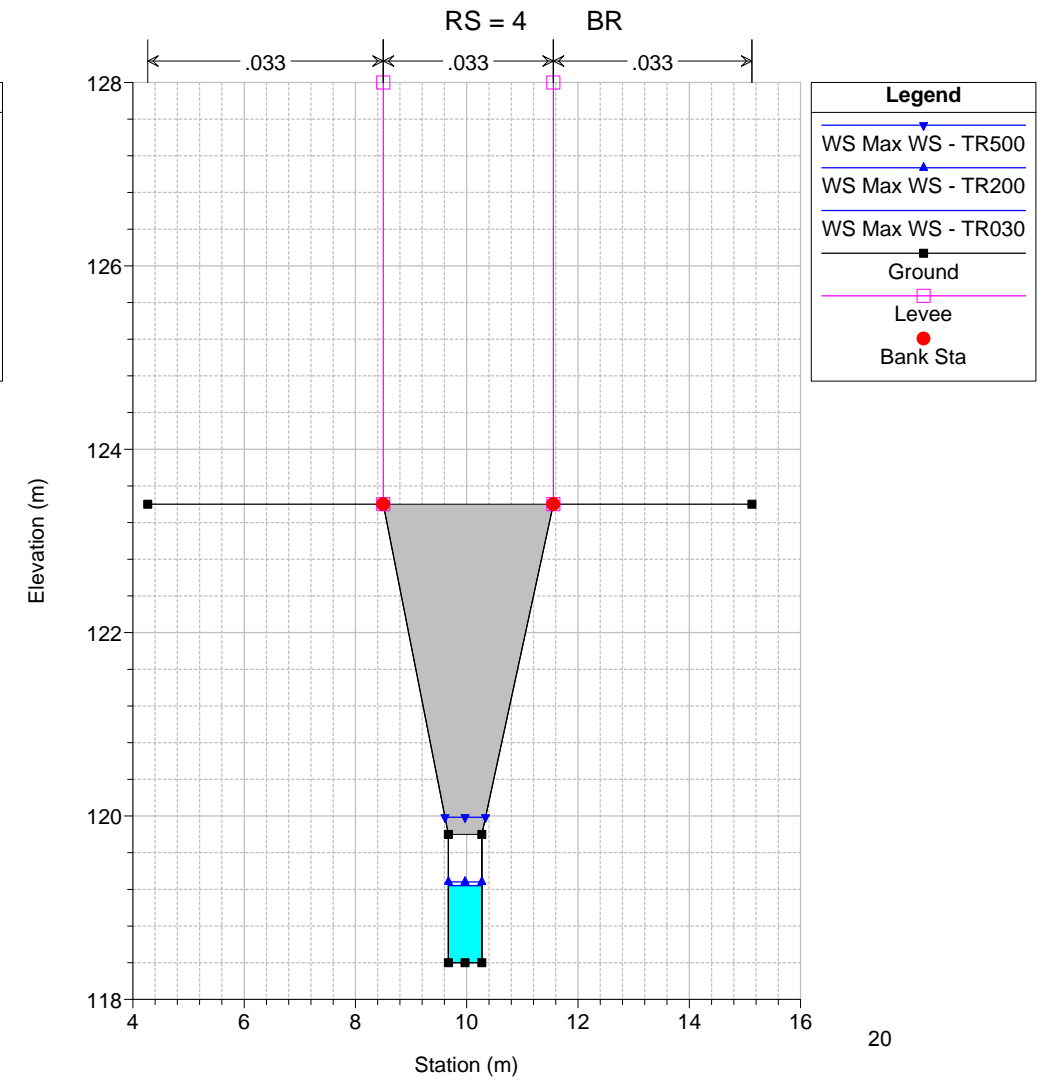
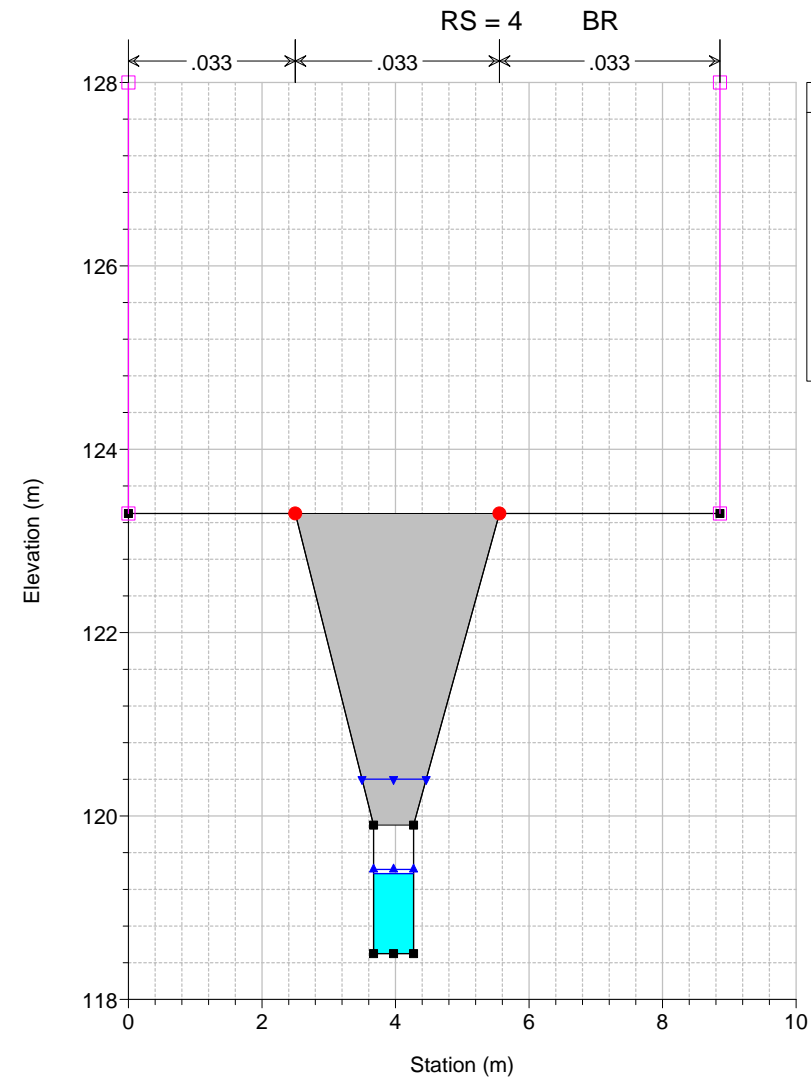
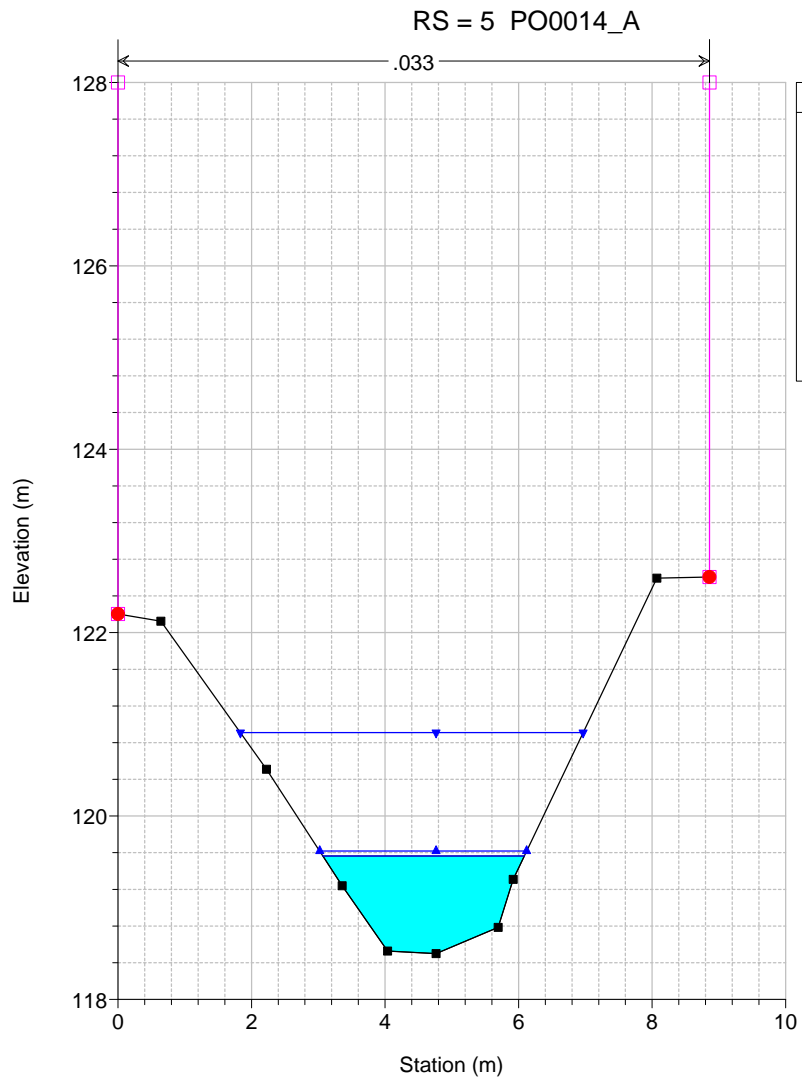
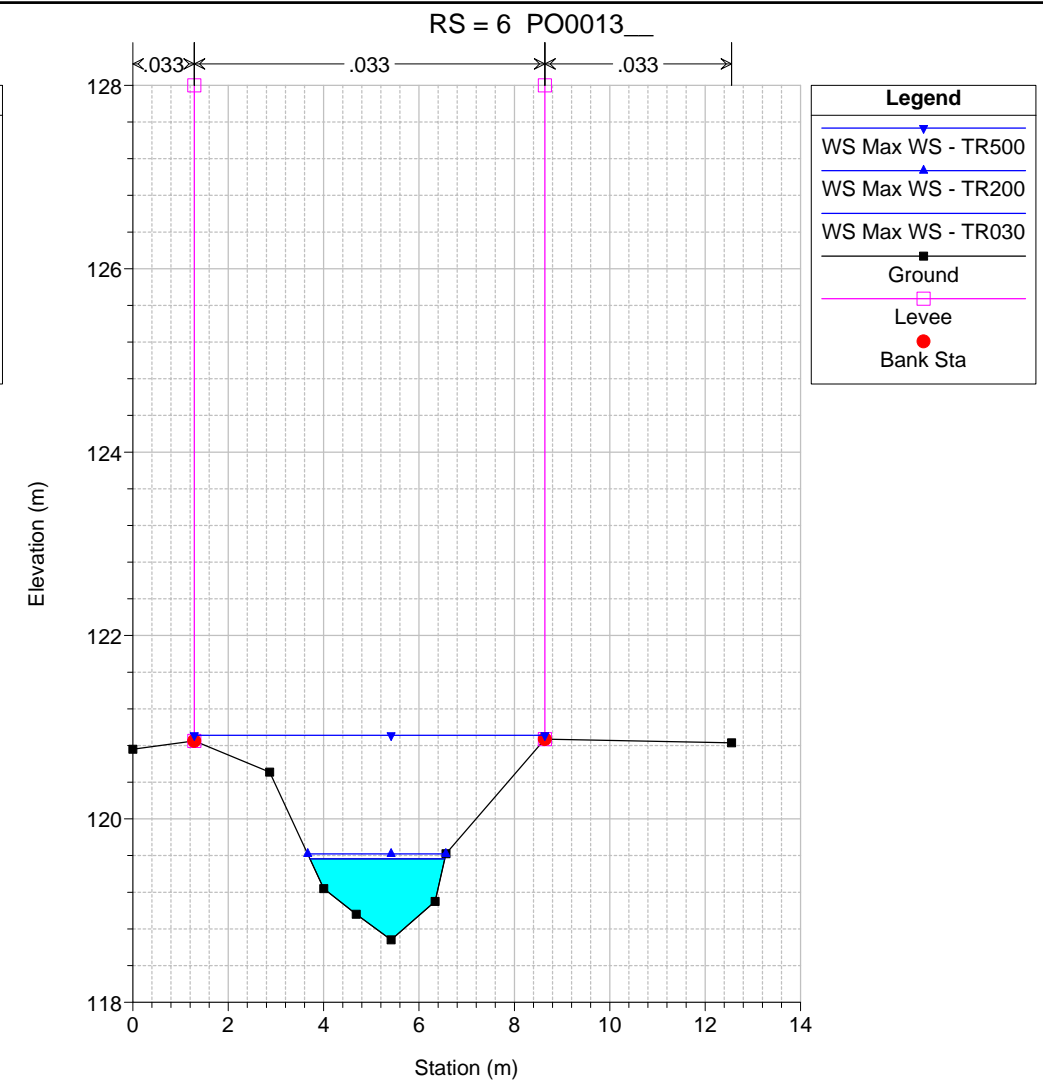
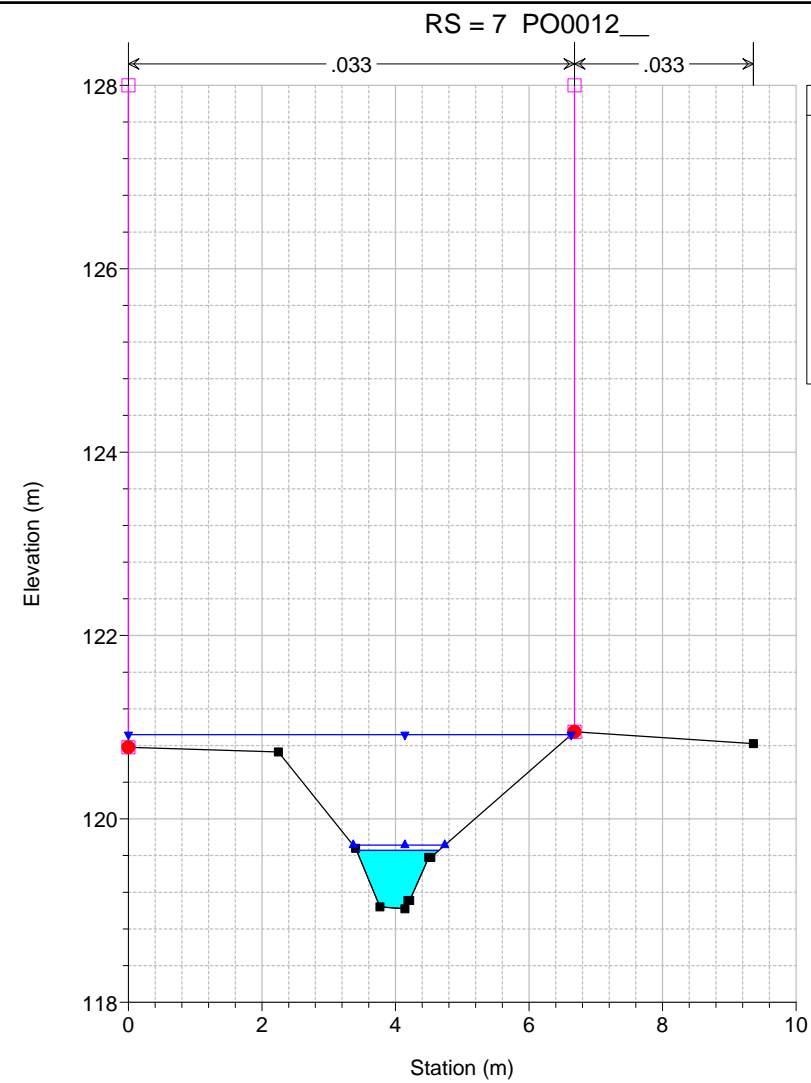
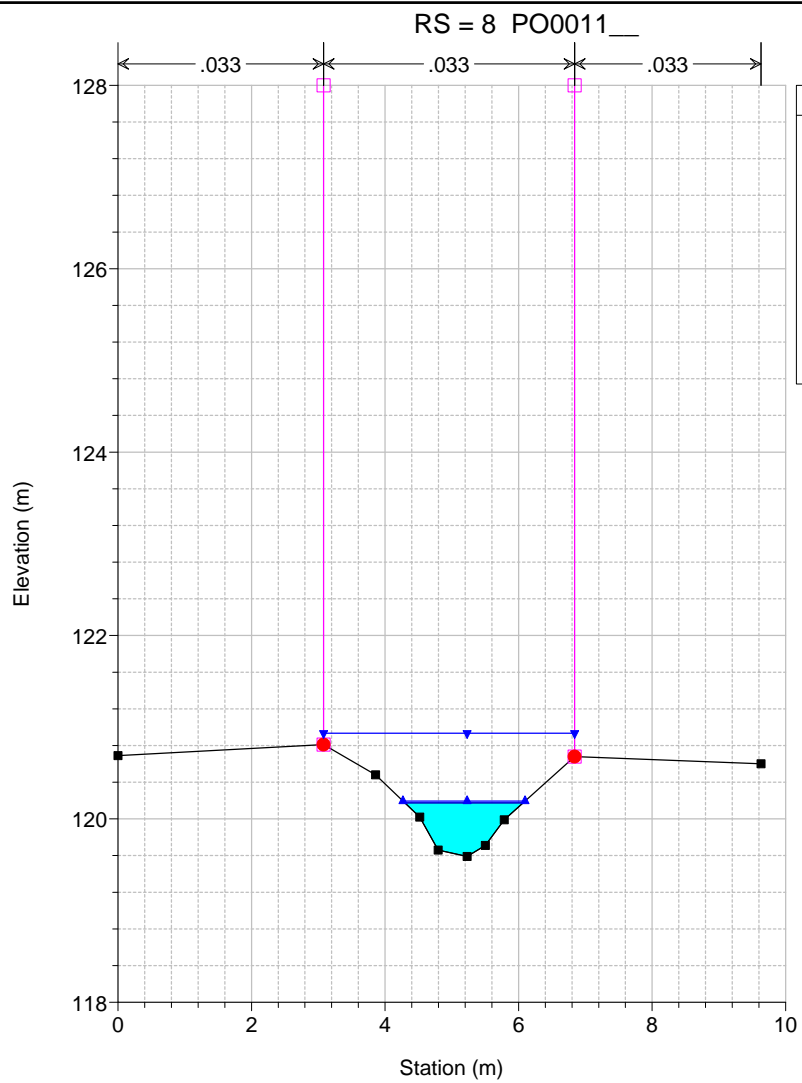

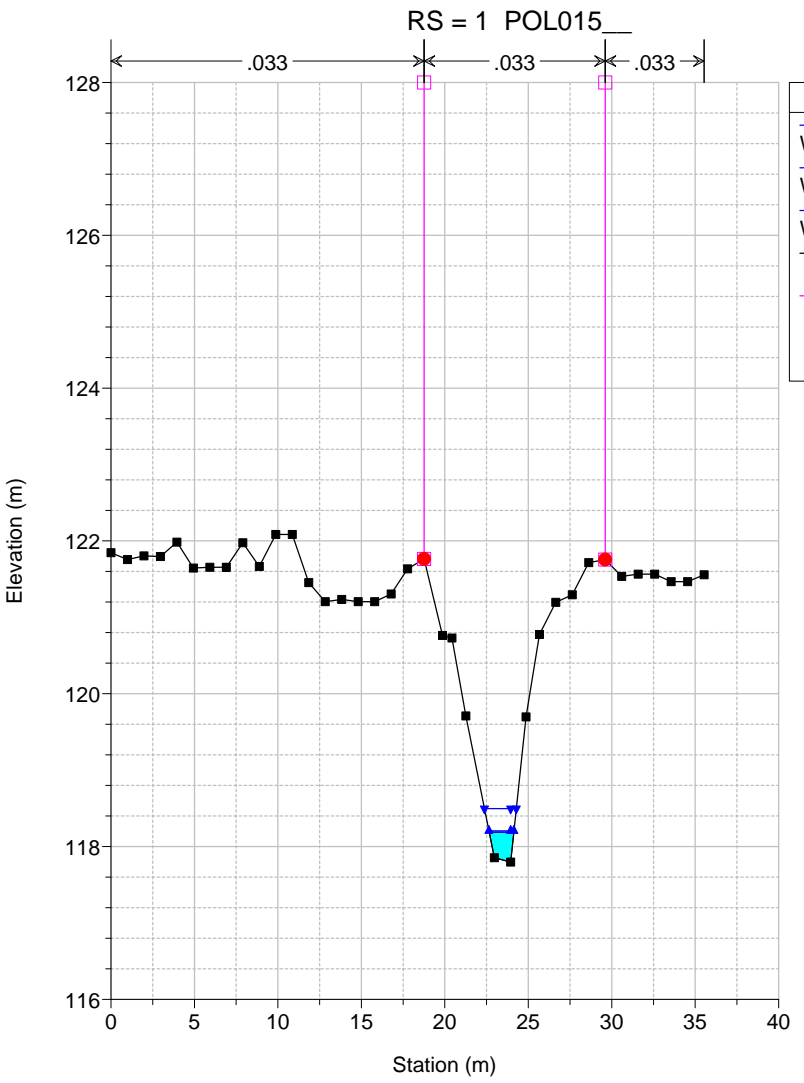
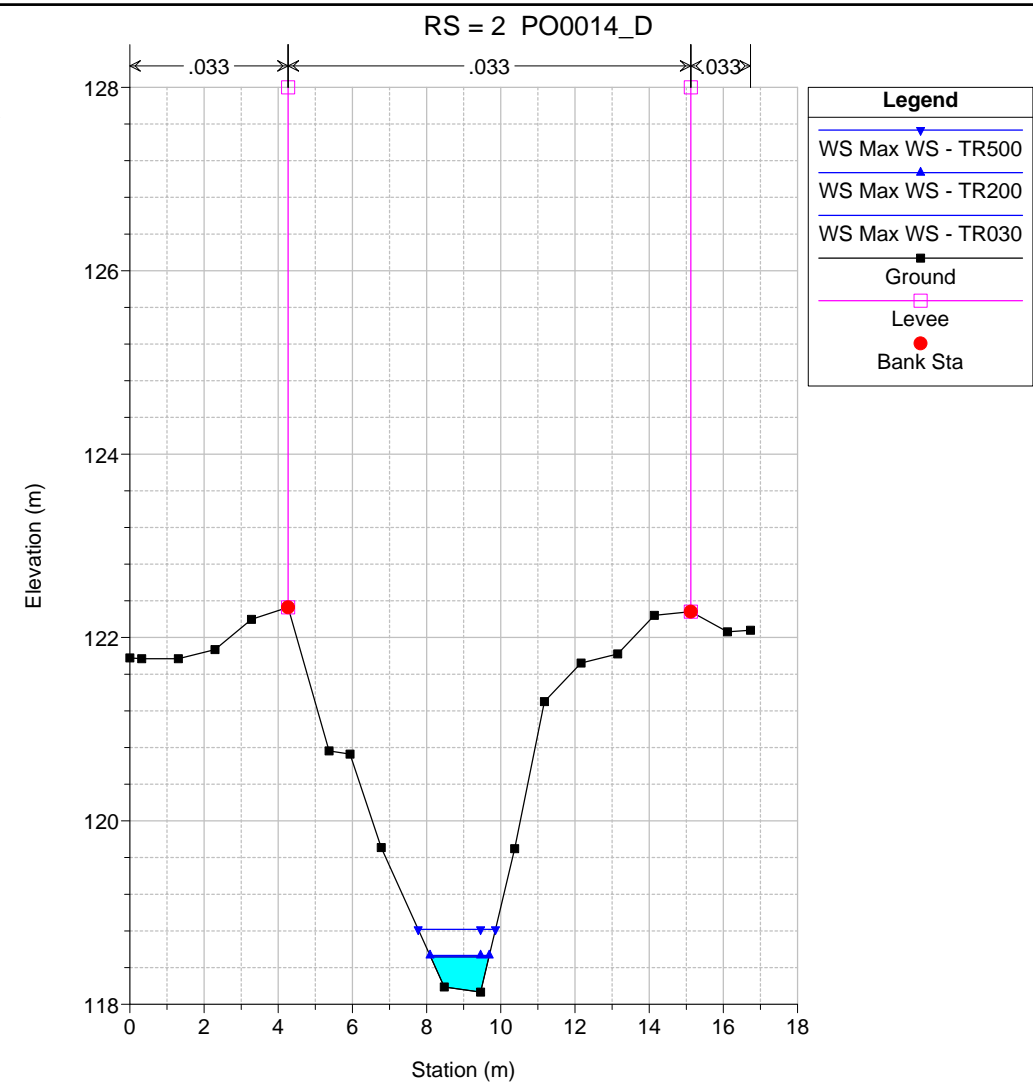
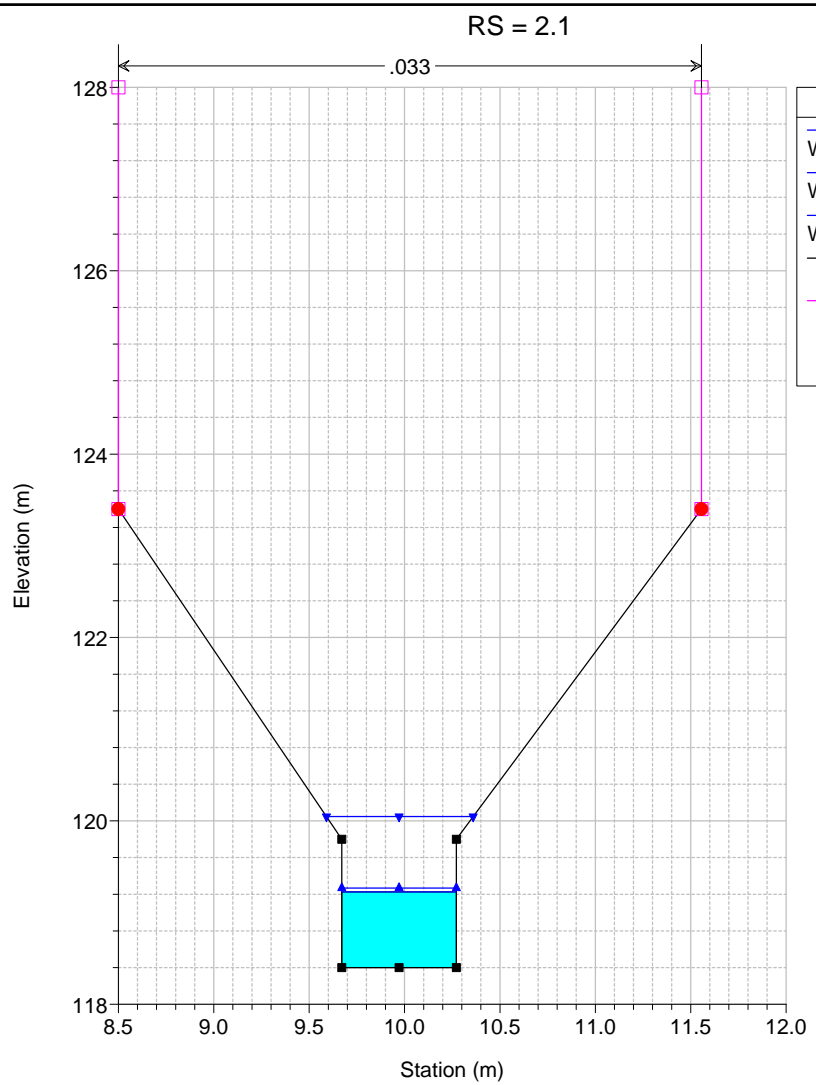
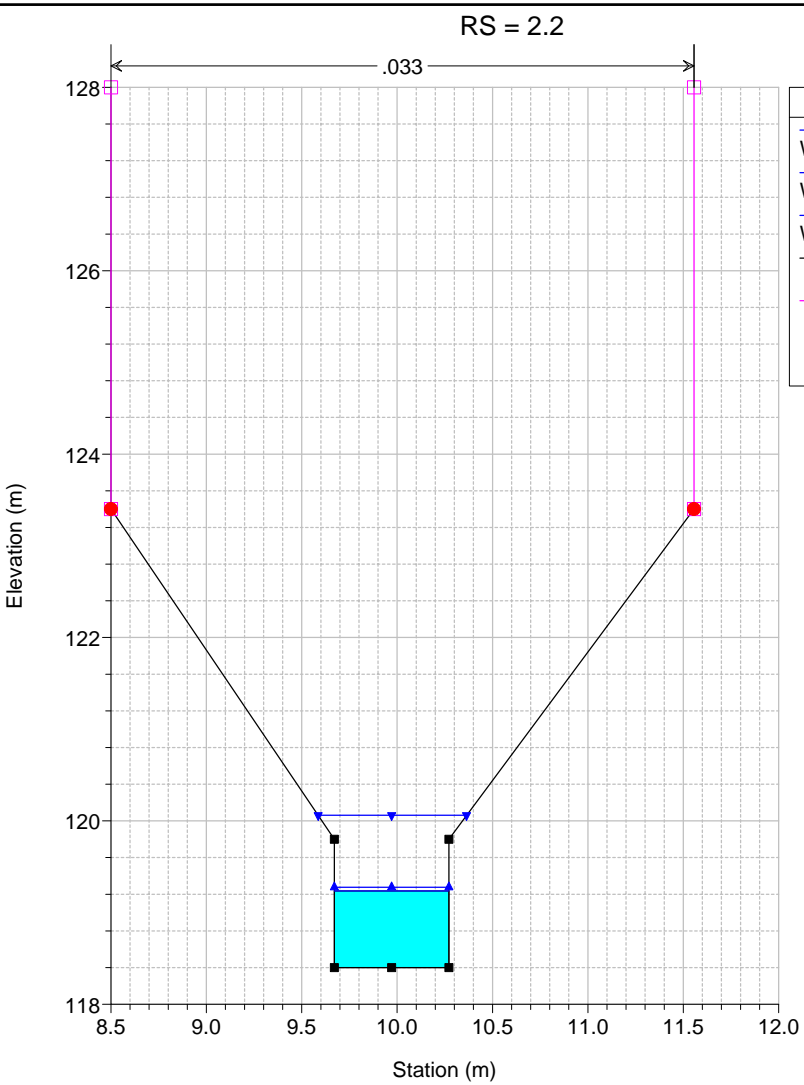

Sezioni fluviali
Fosso Podere Cappella
Tempo di ritorno: 30, 200 e 500 anni

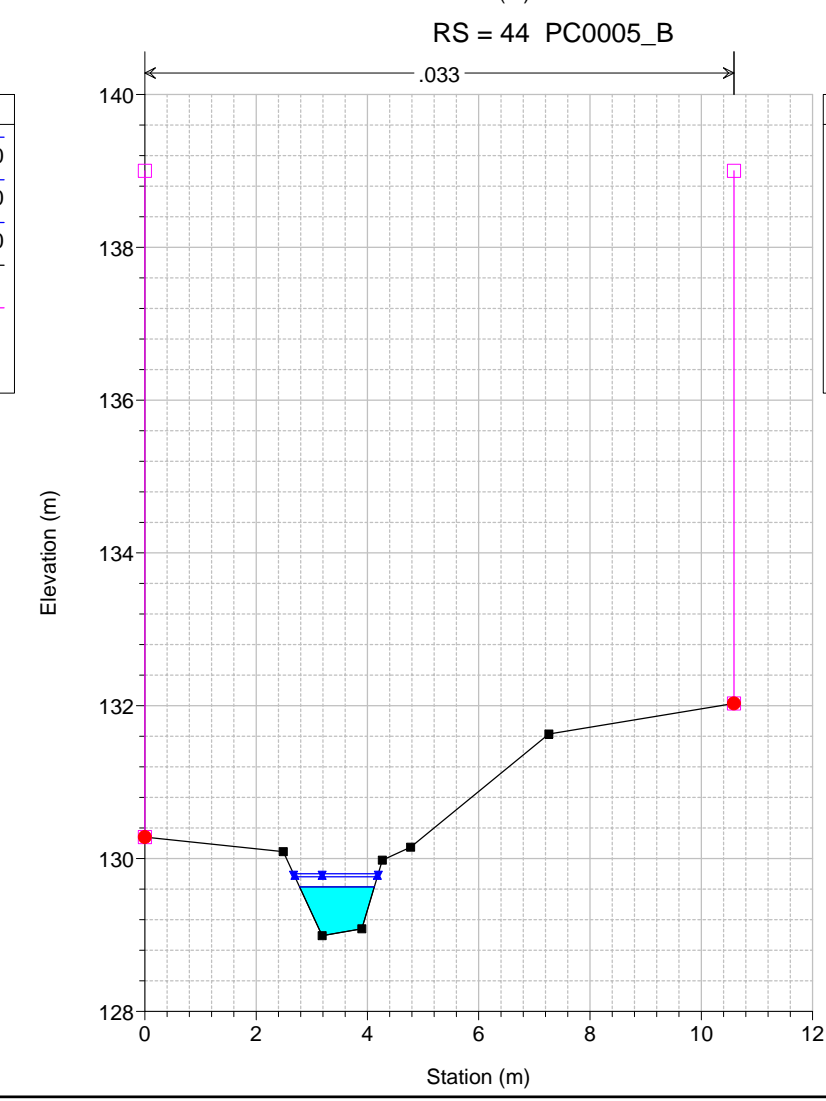
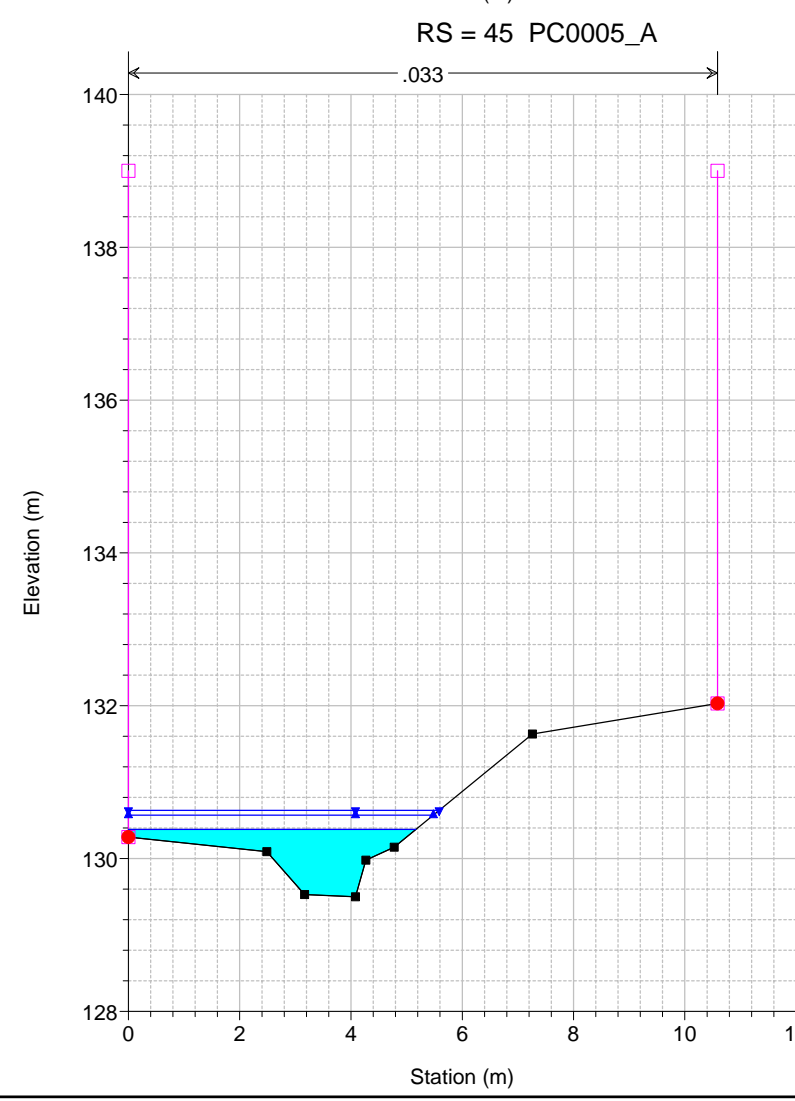
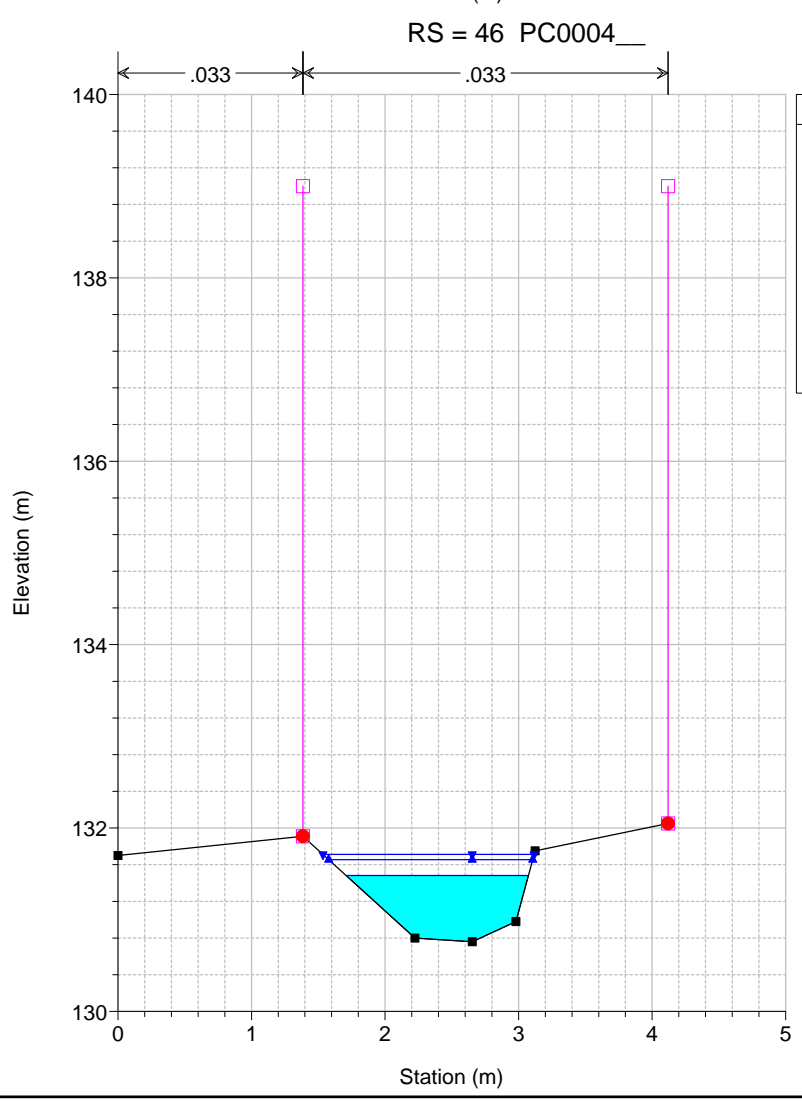
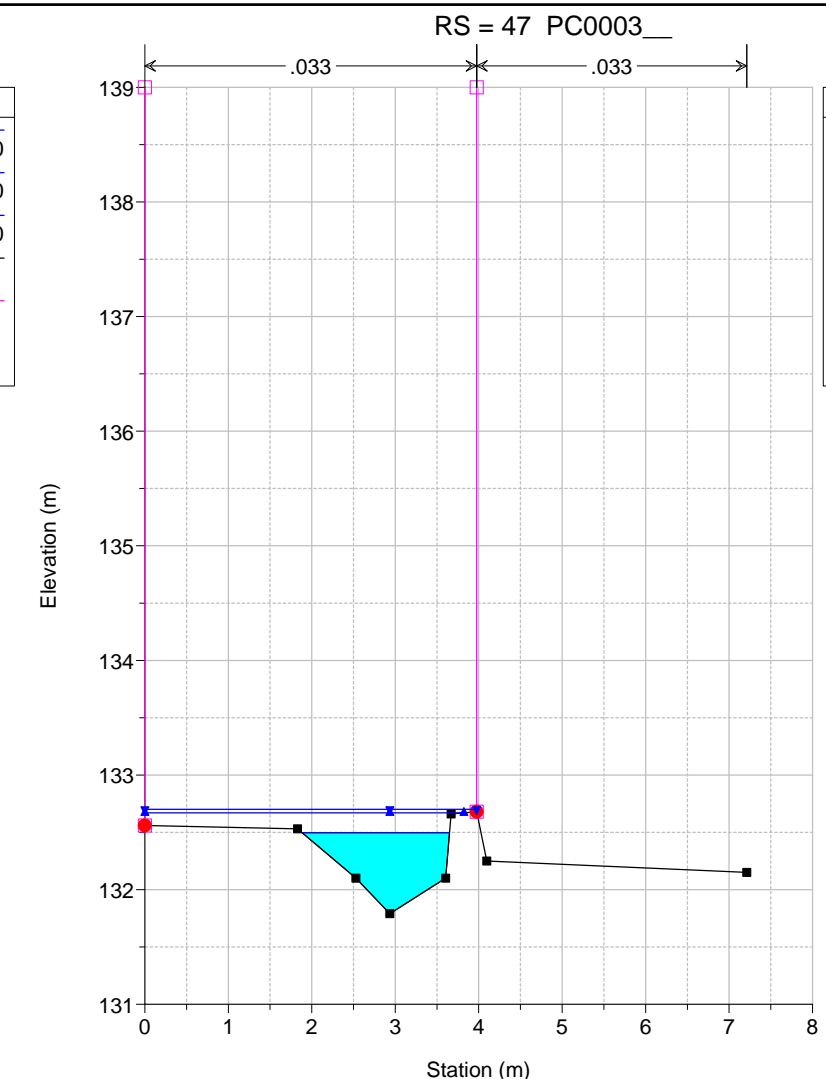
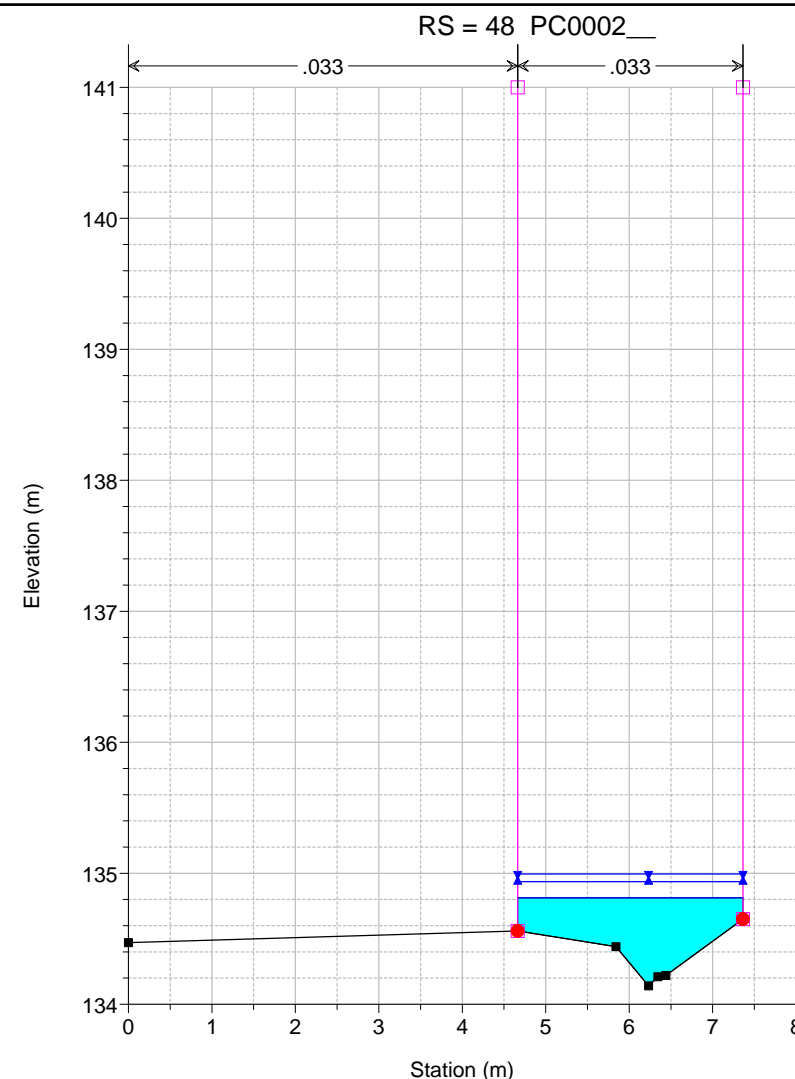
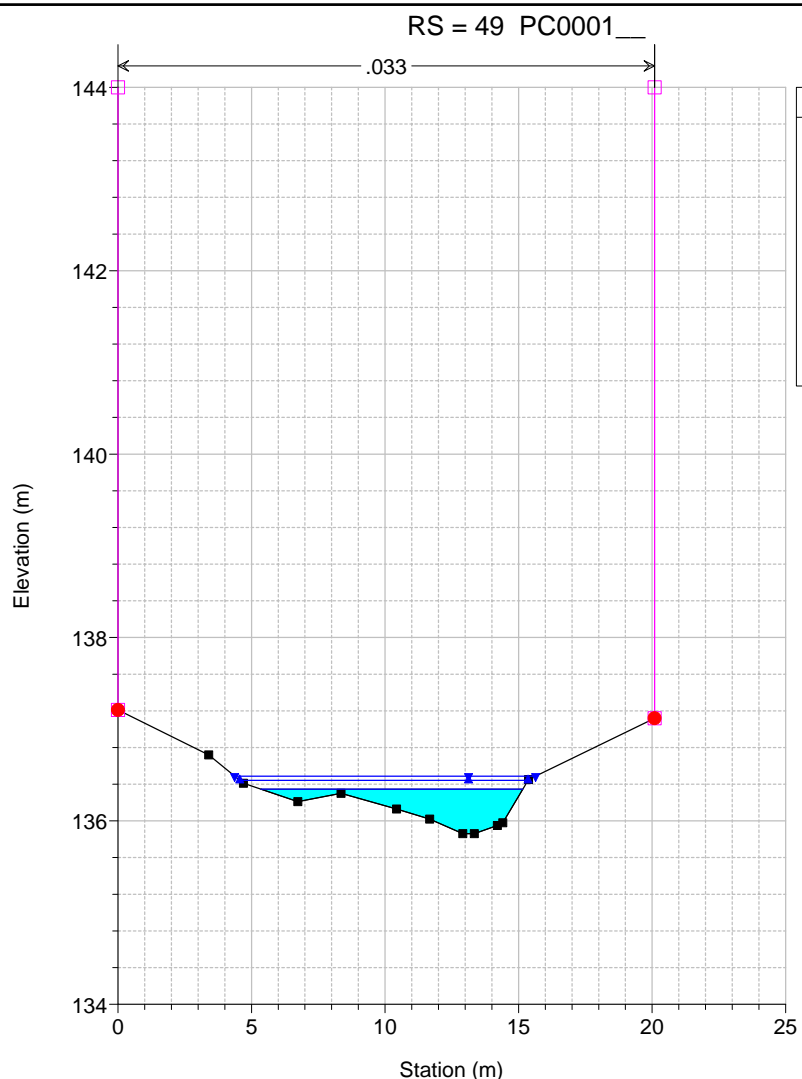

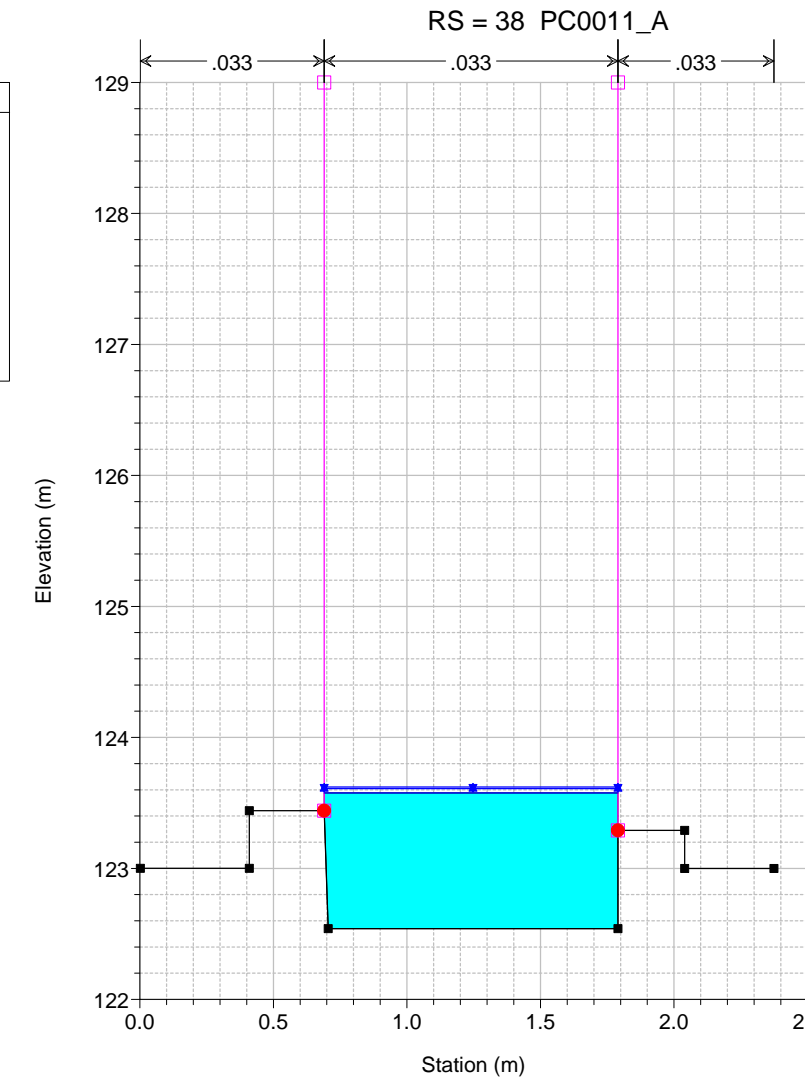
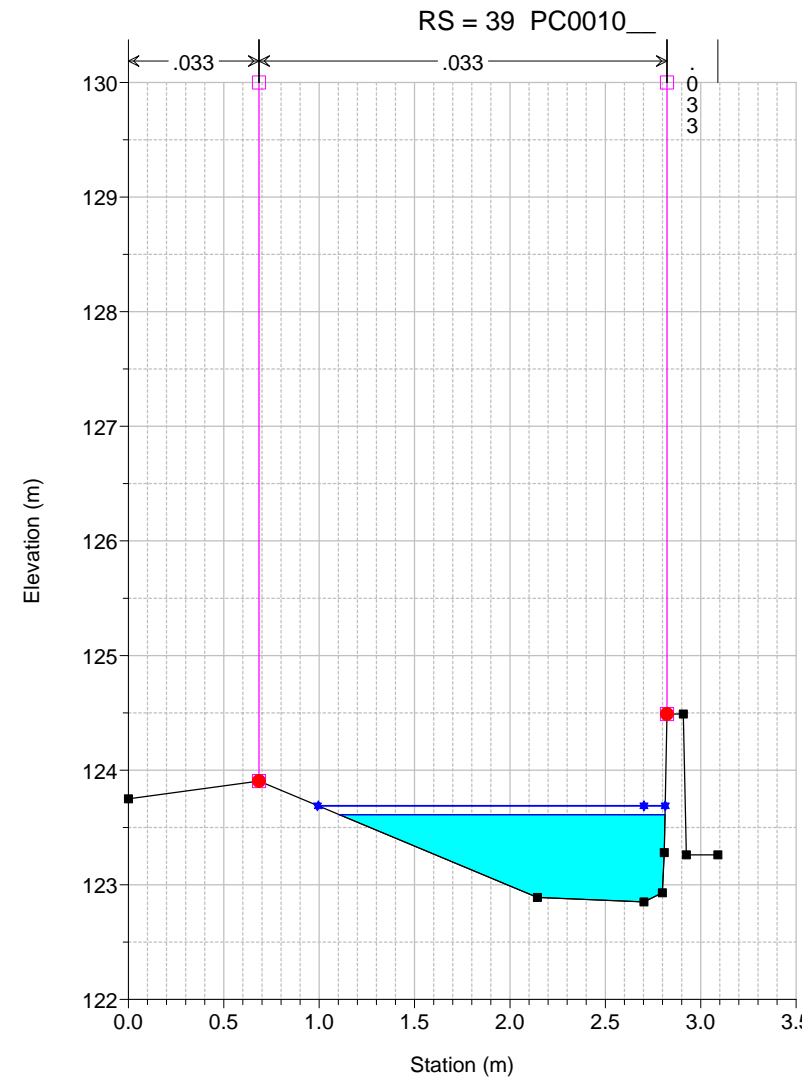
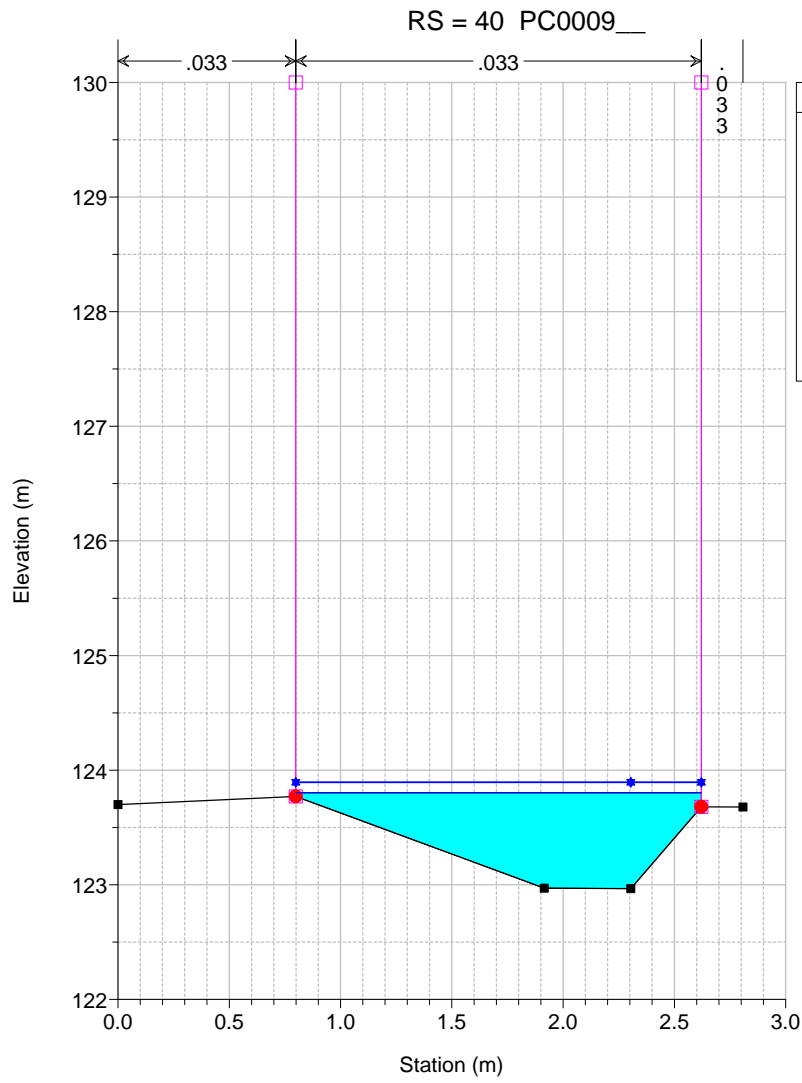
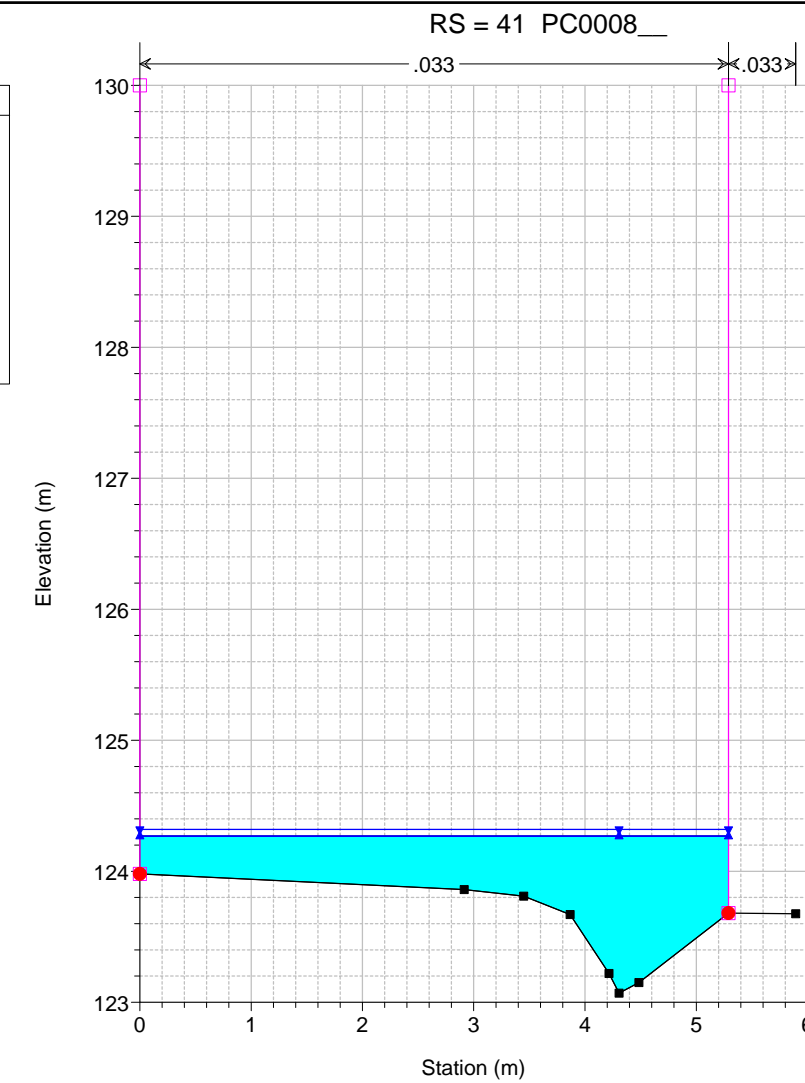
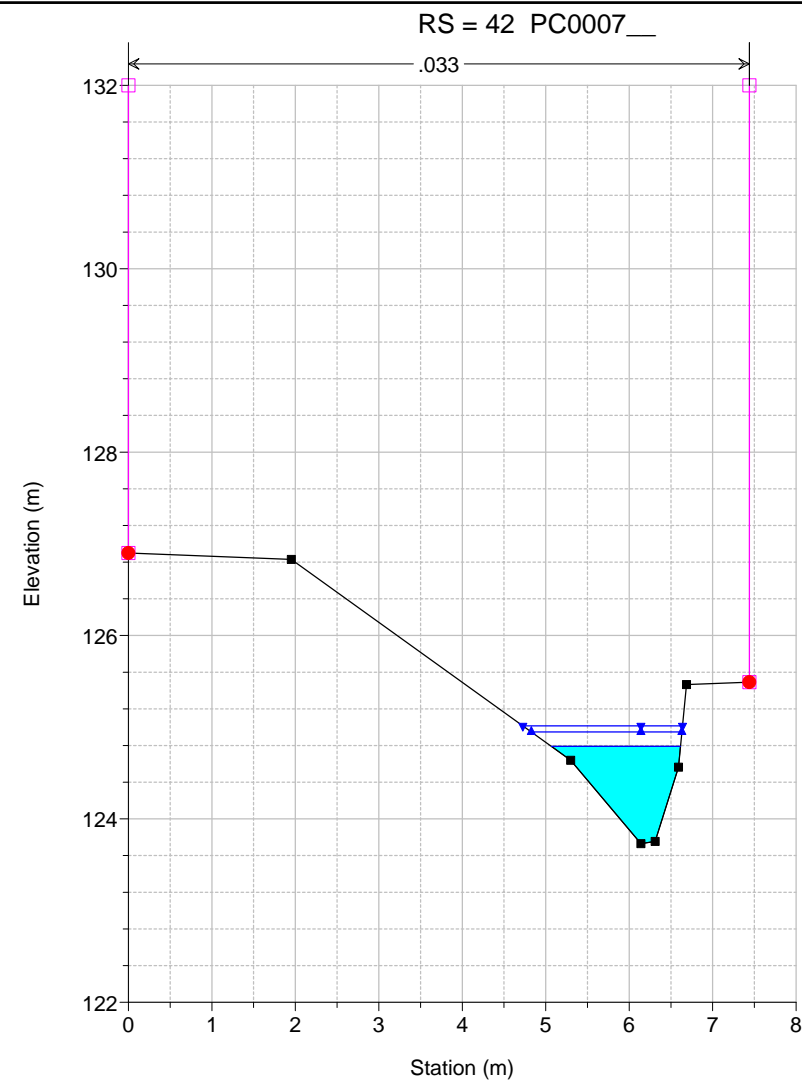
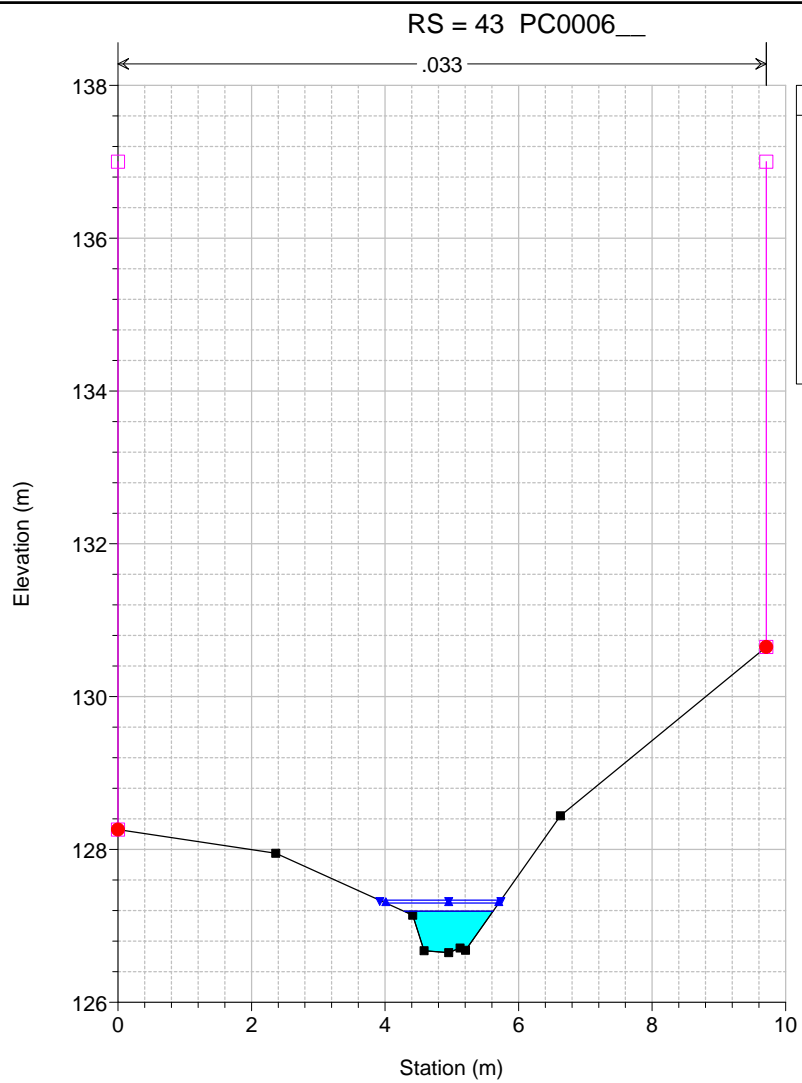

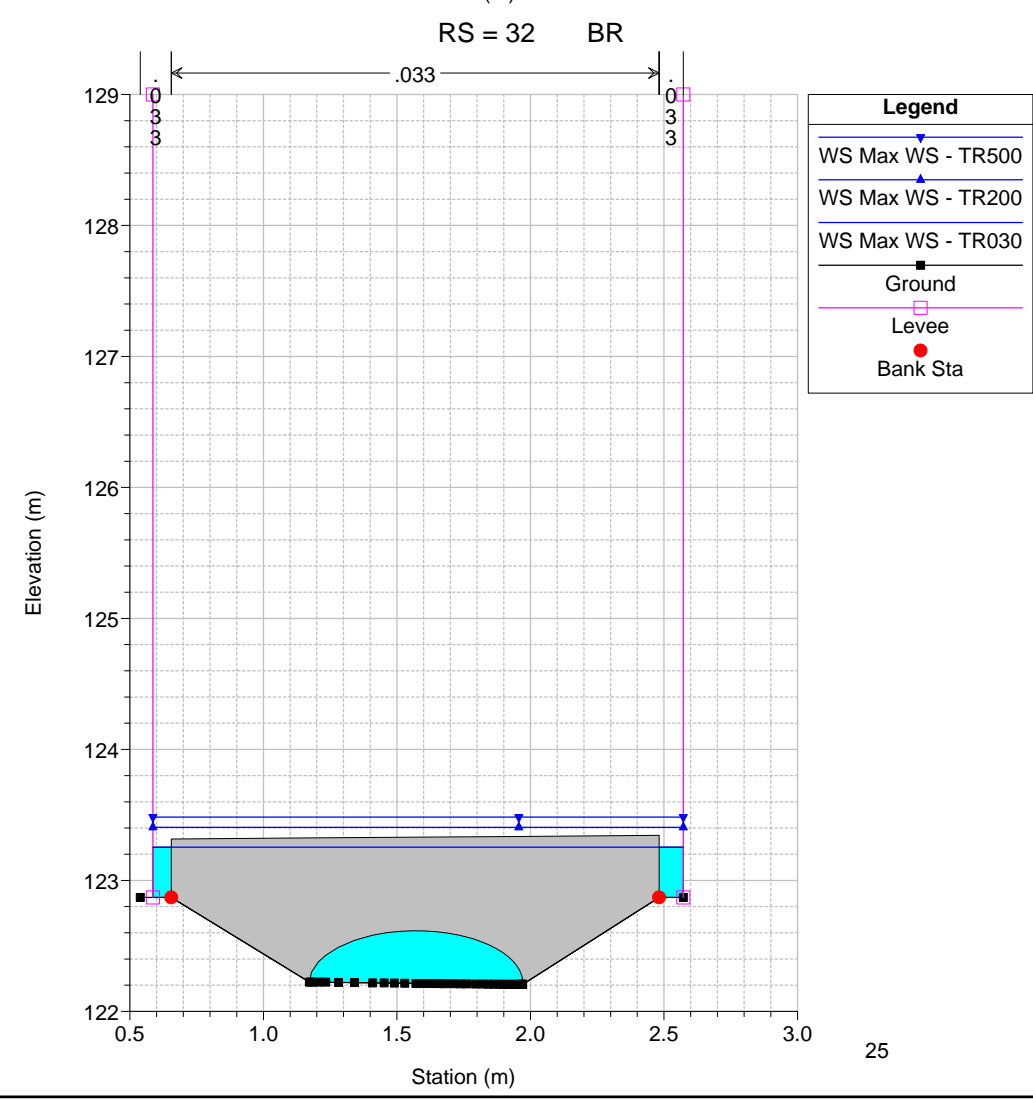
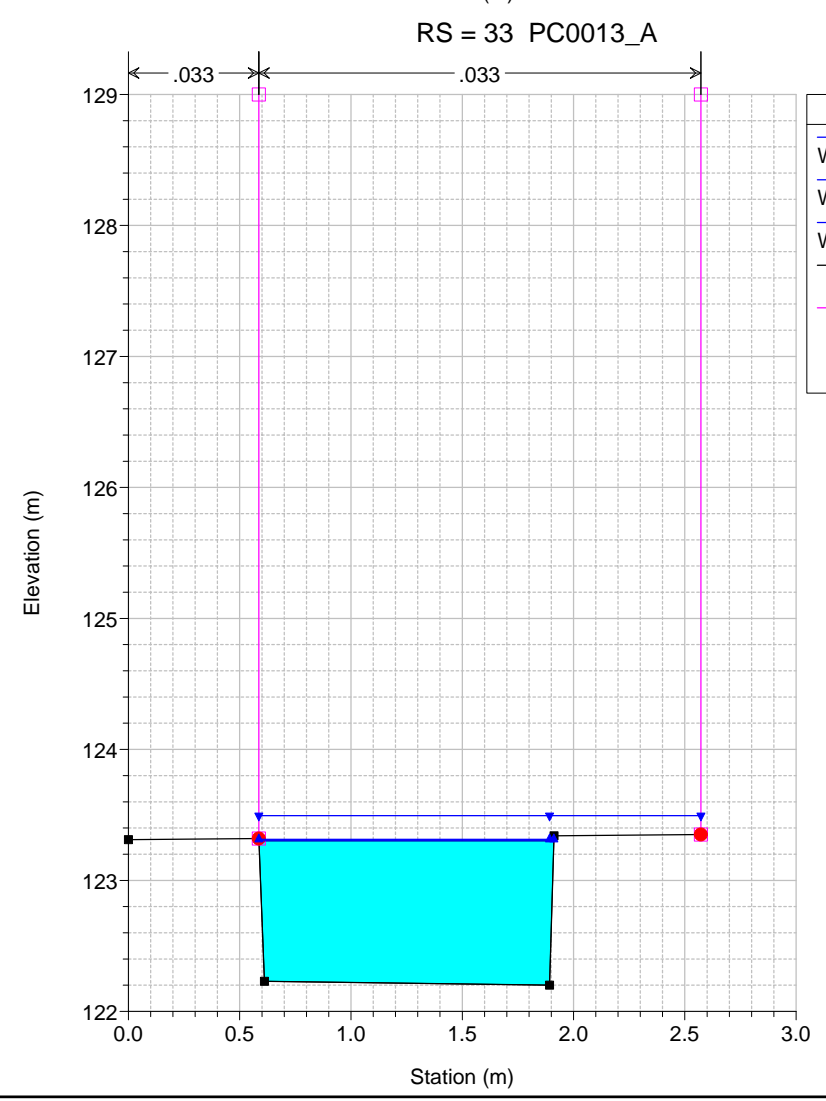
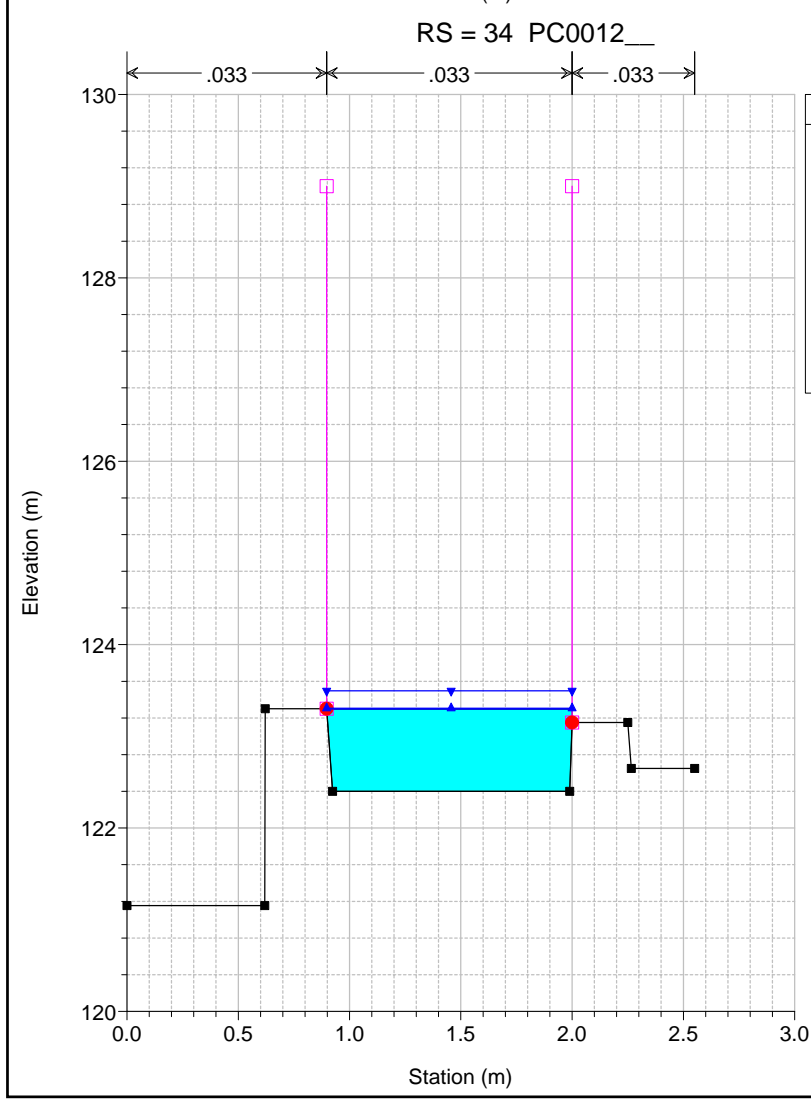
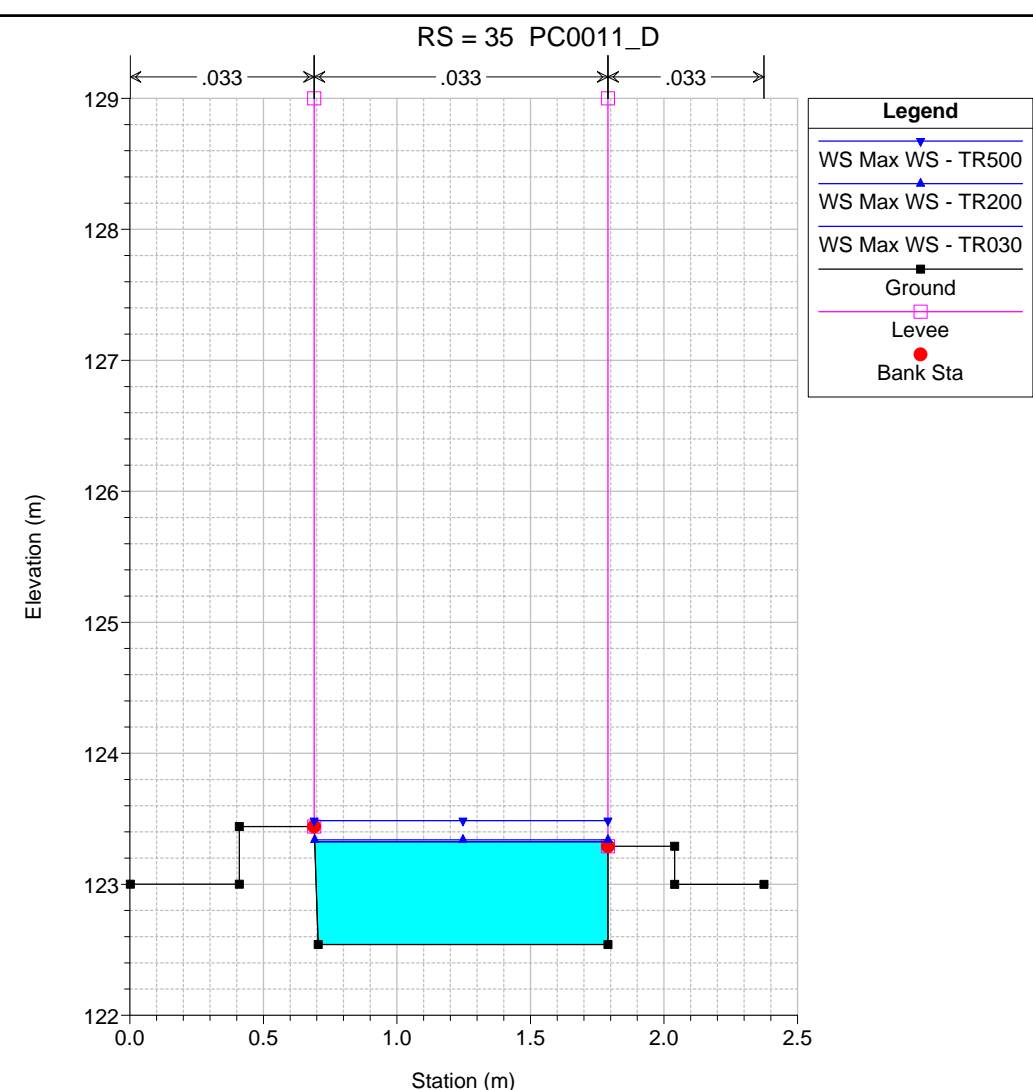
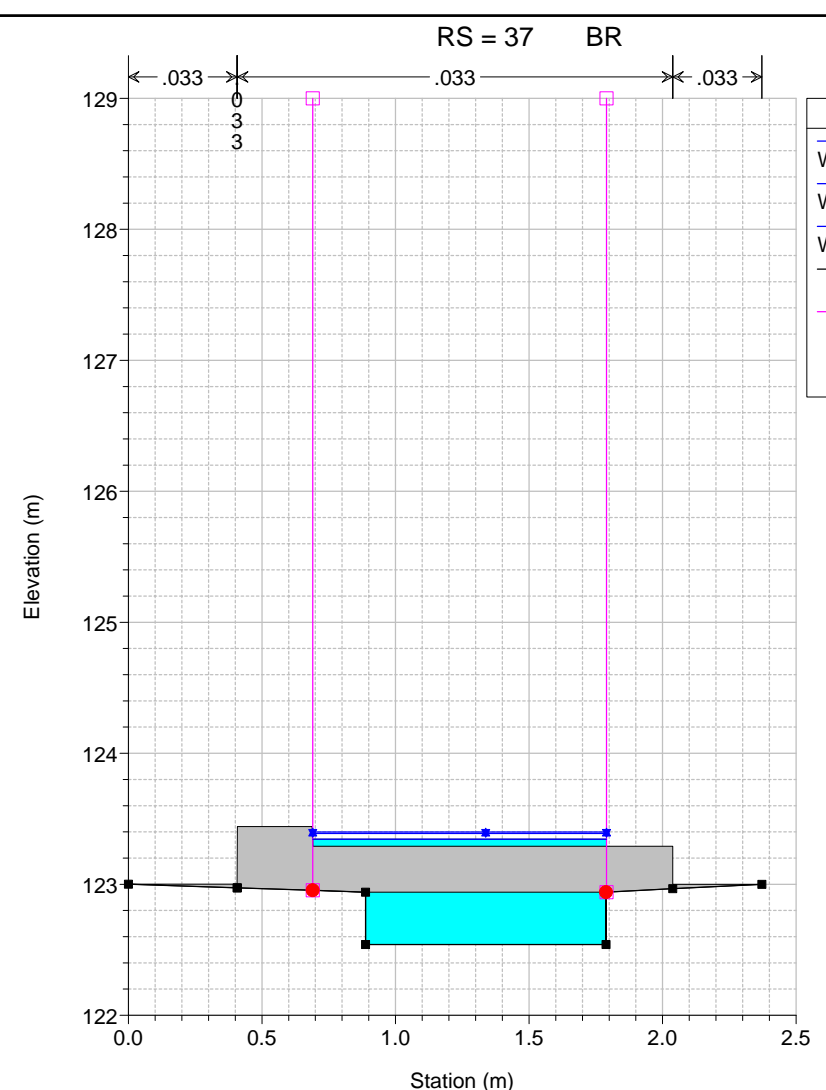
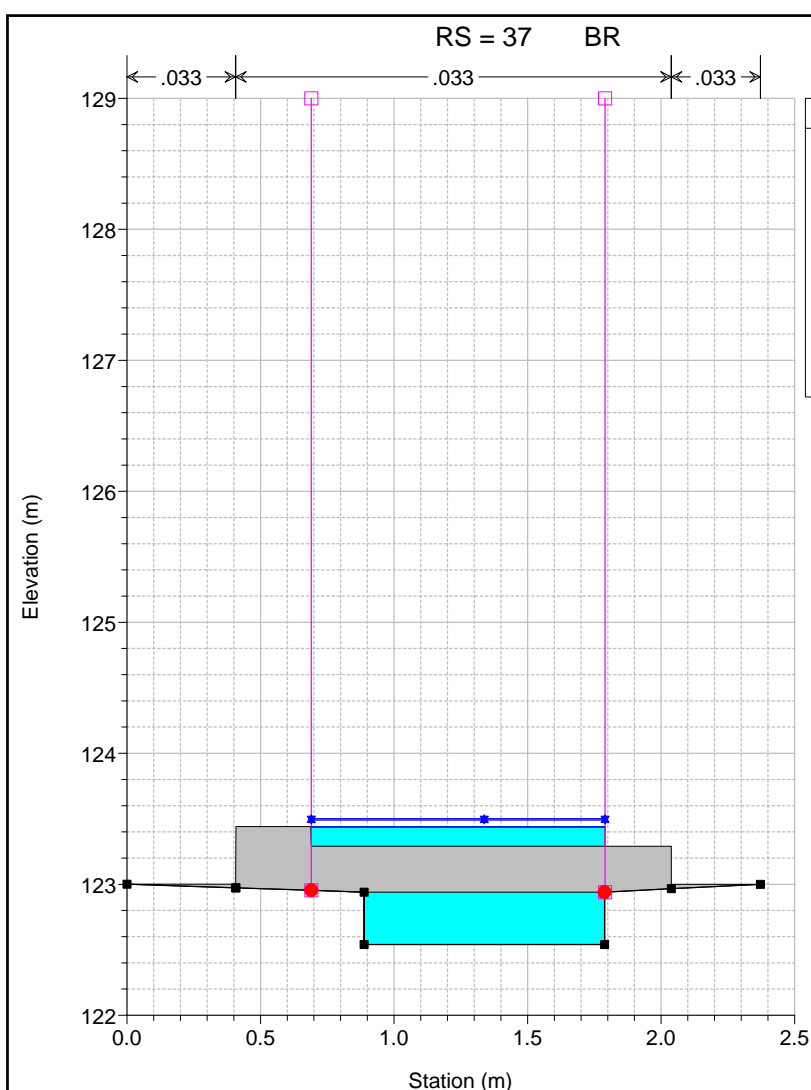

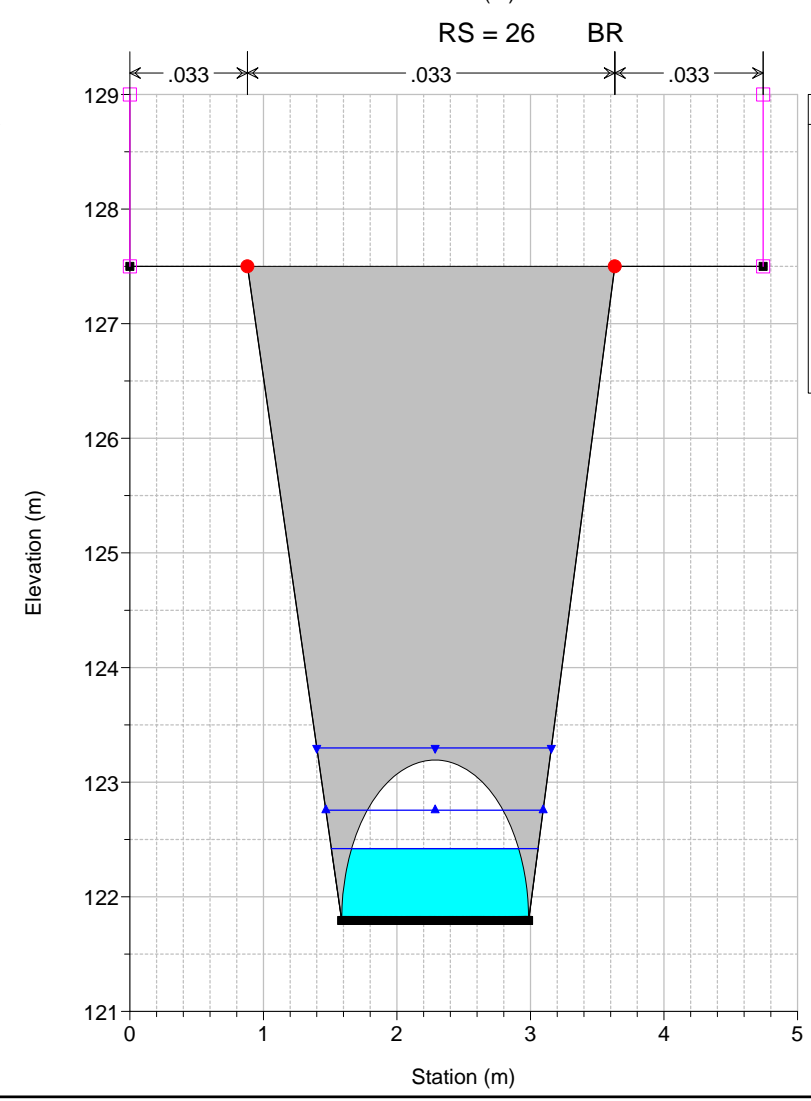
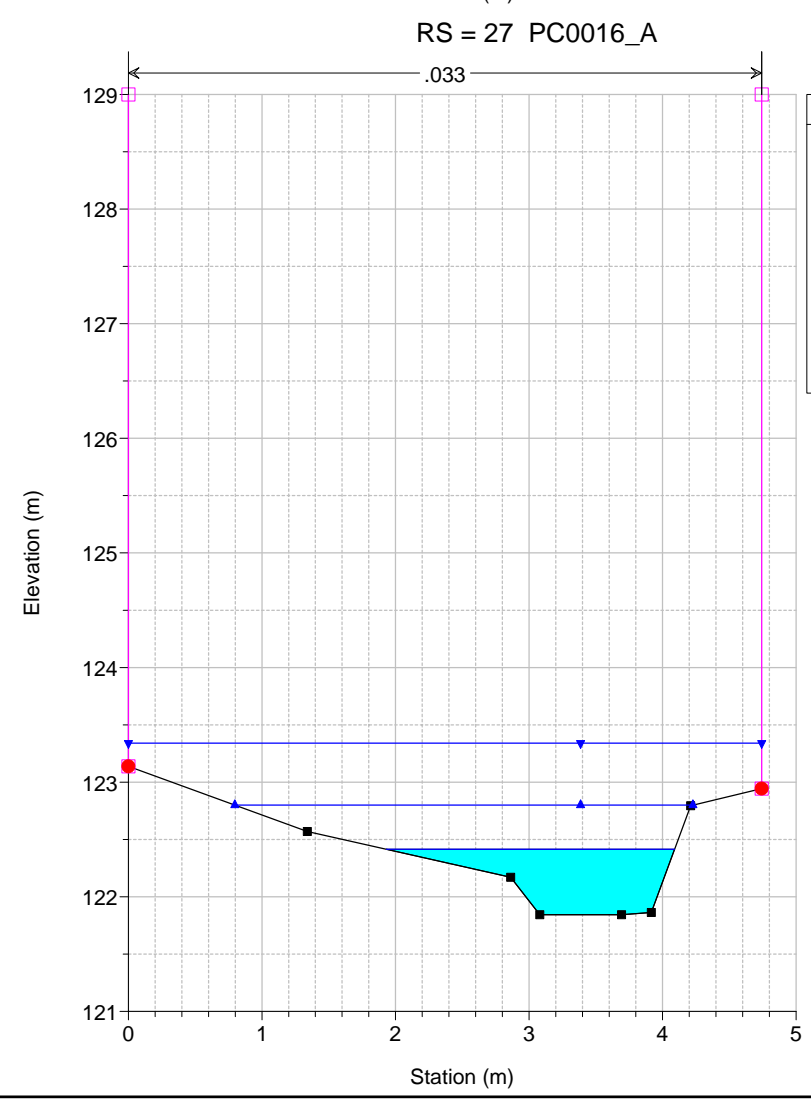
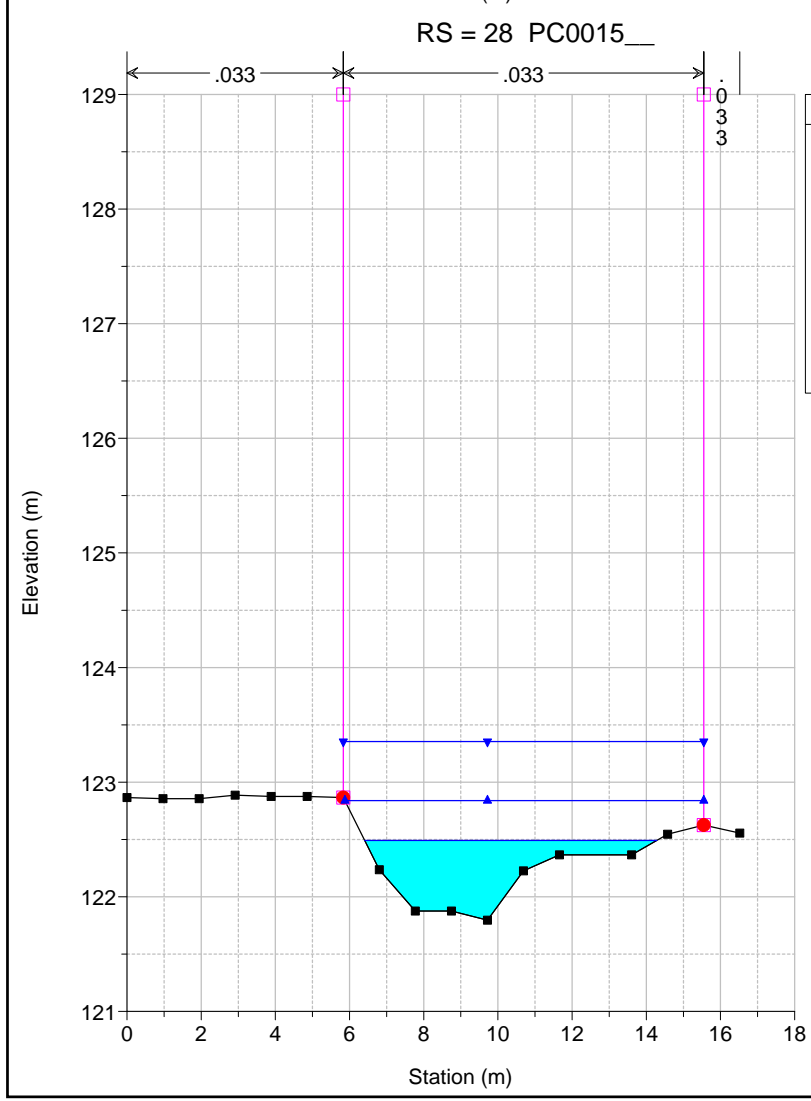
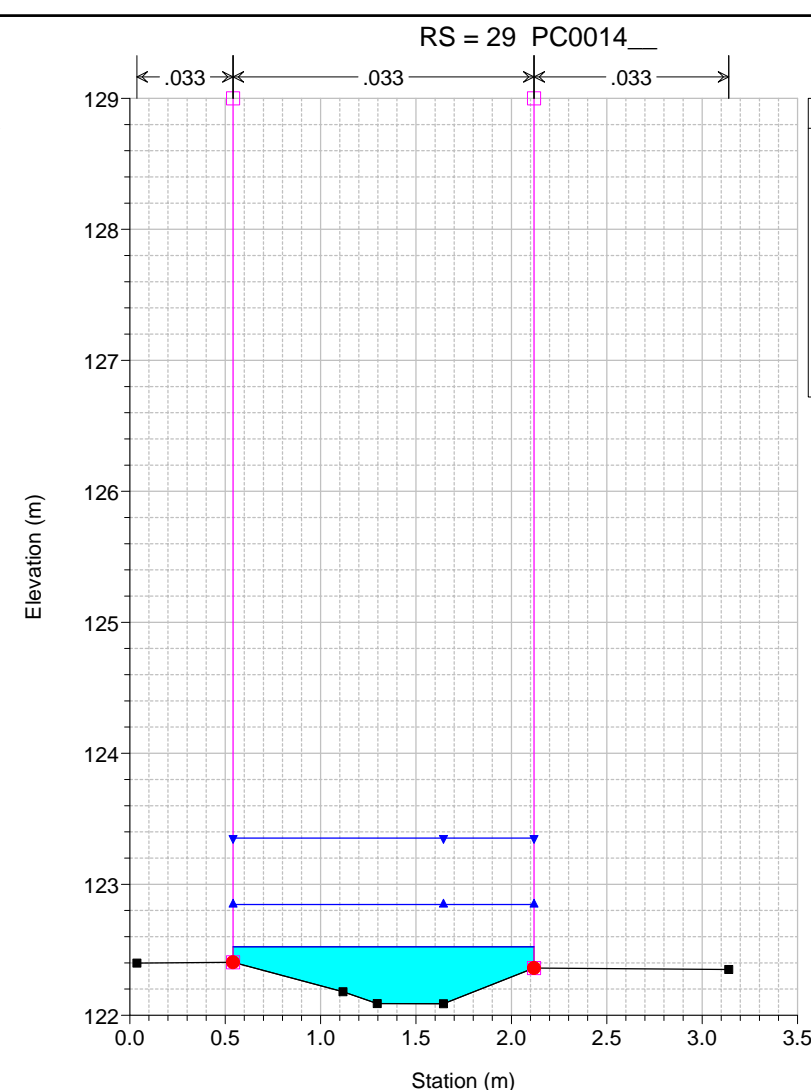
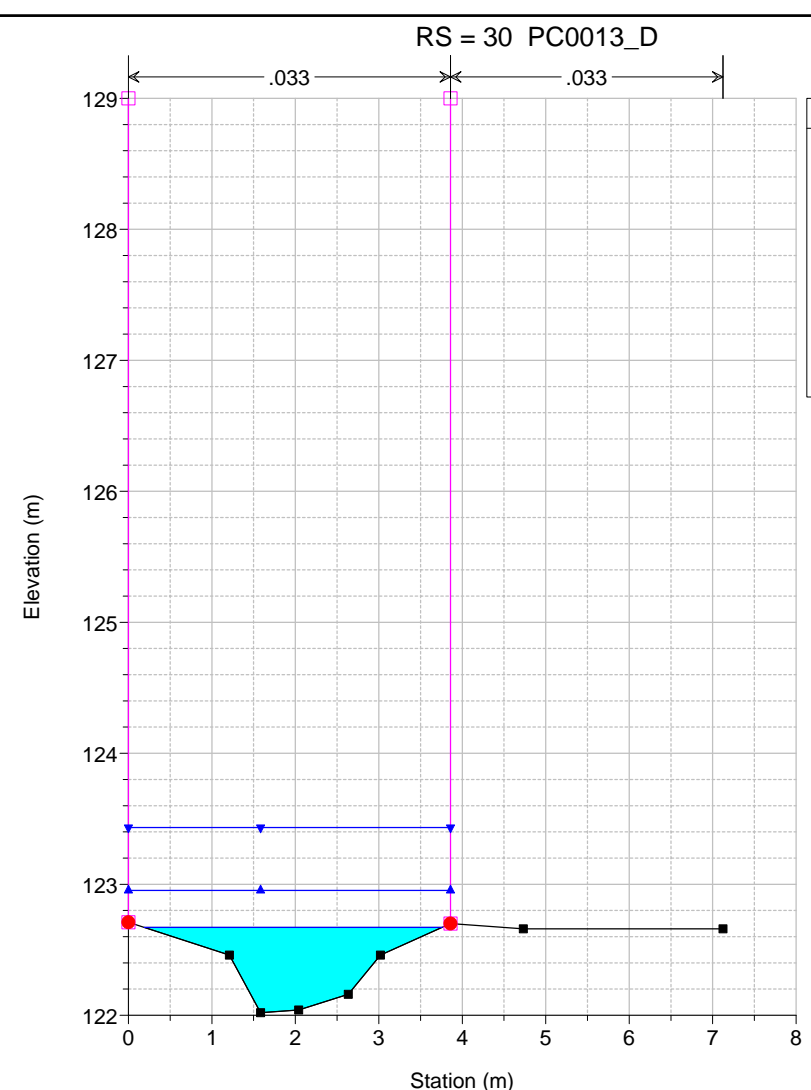
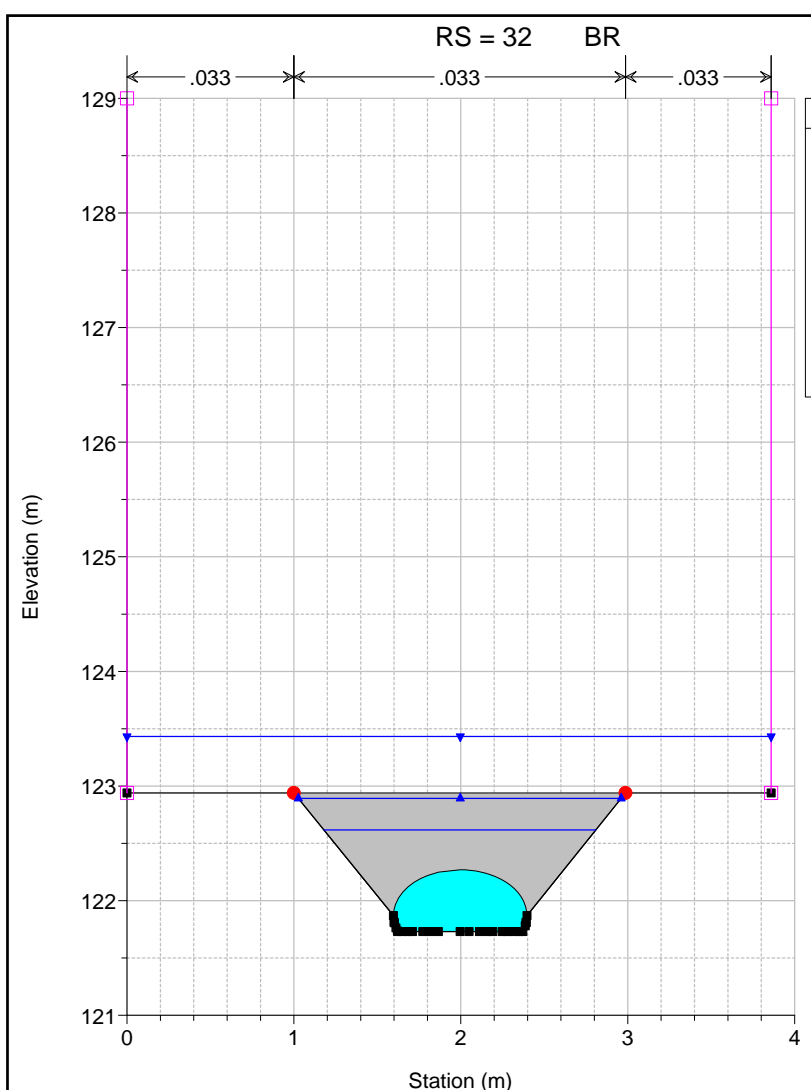

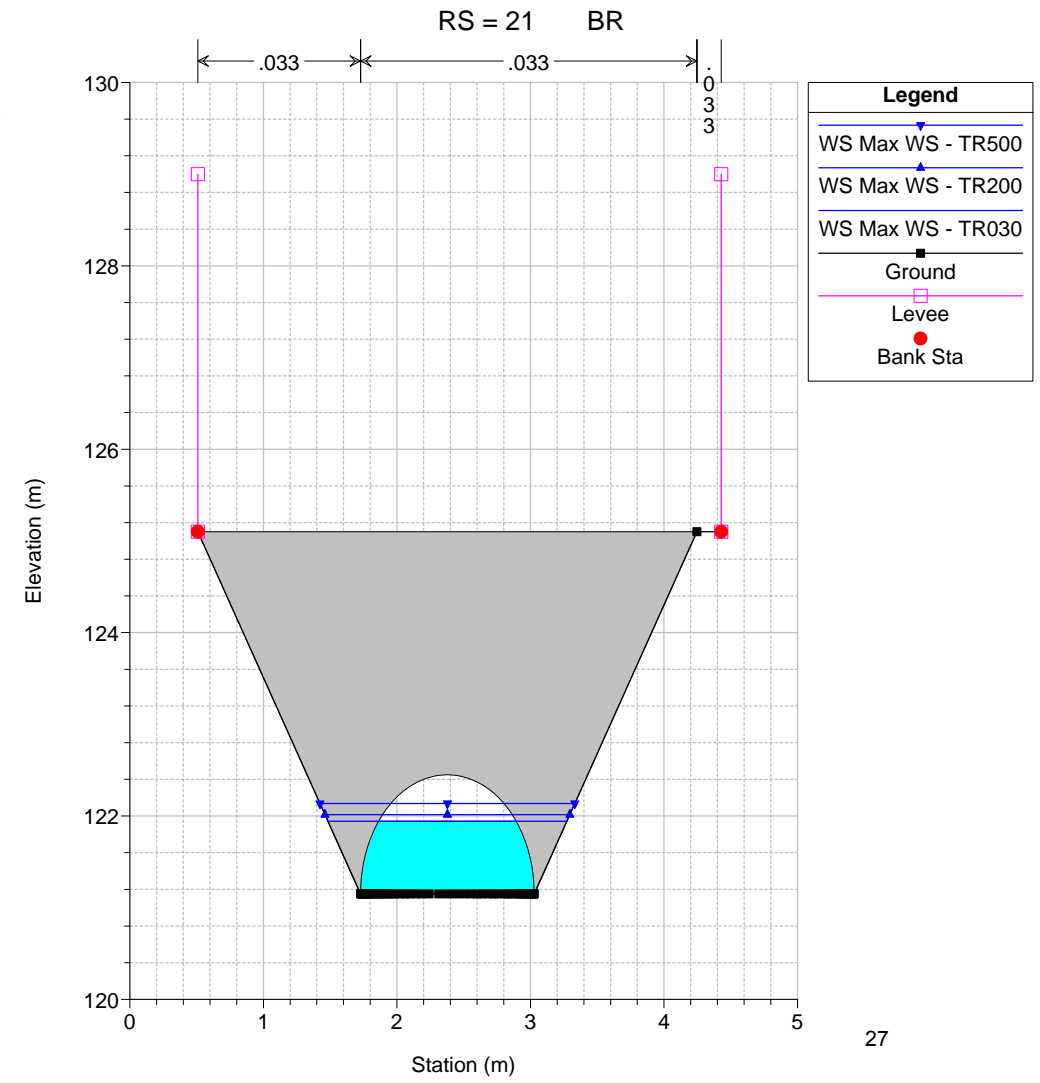
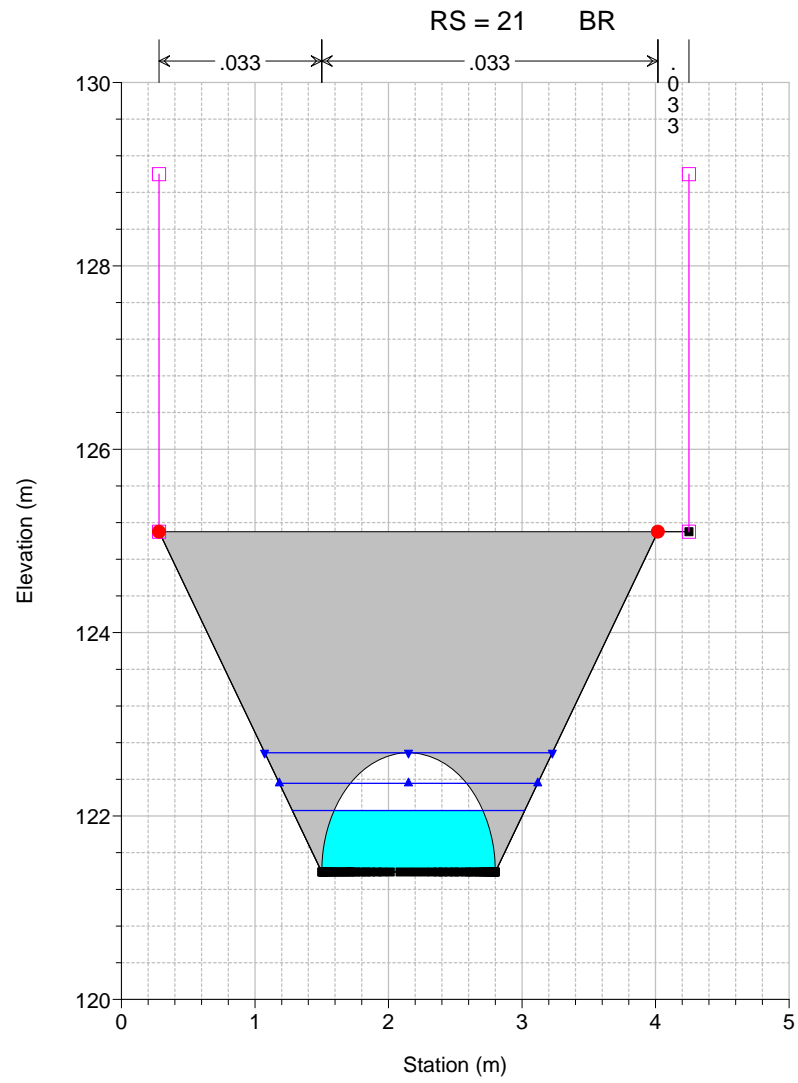
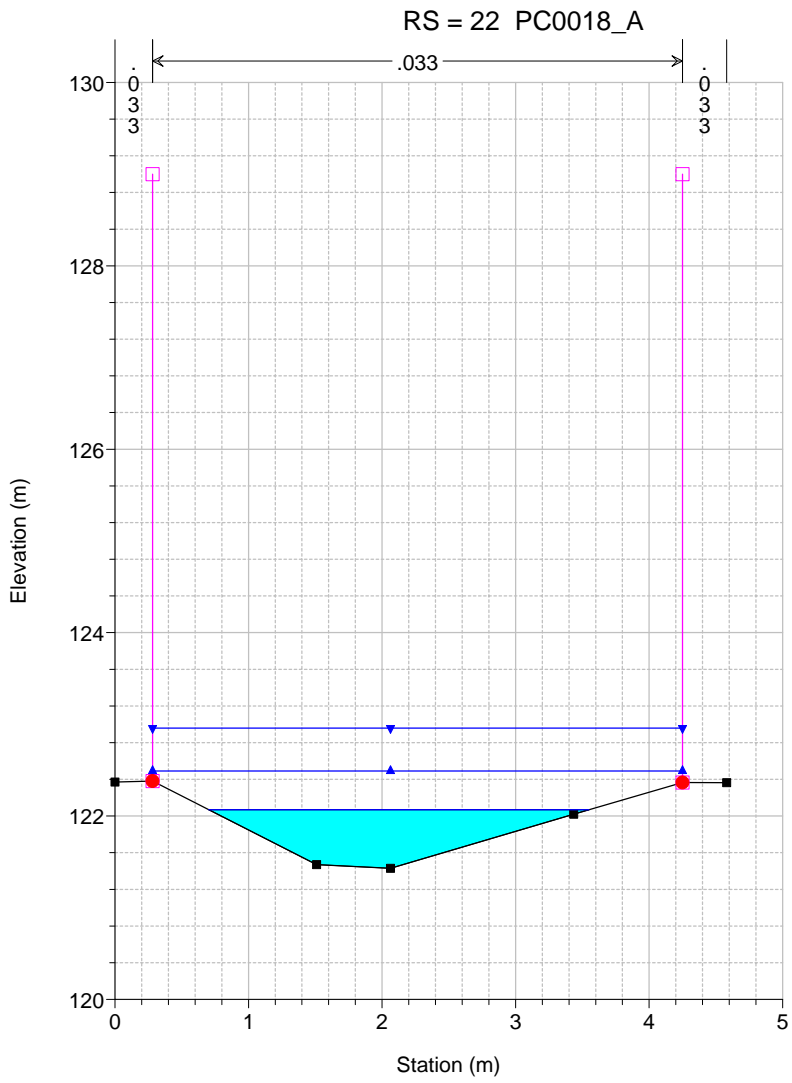
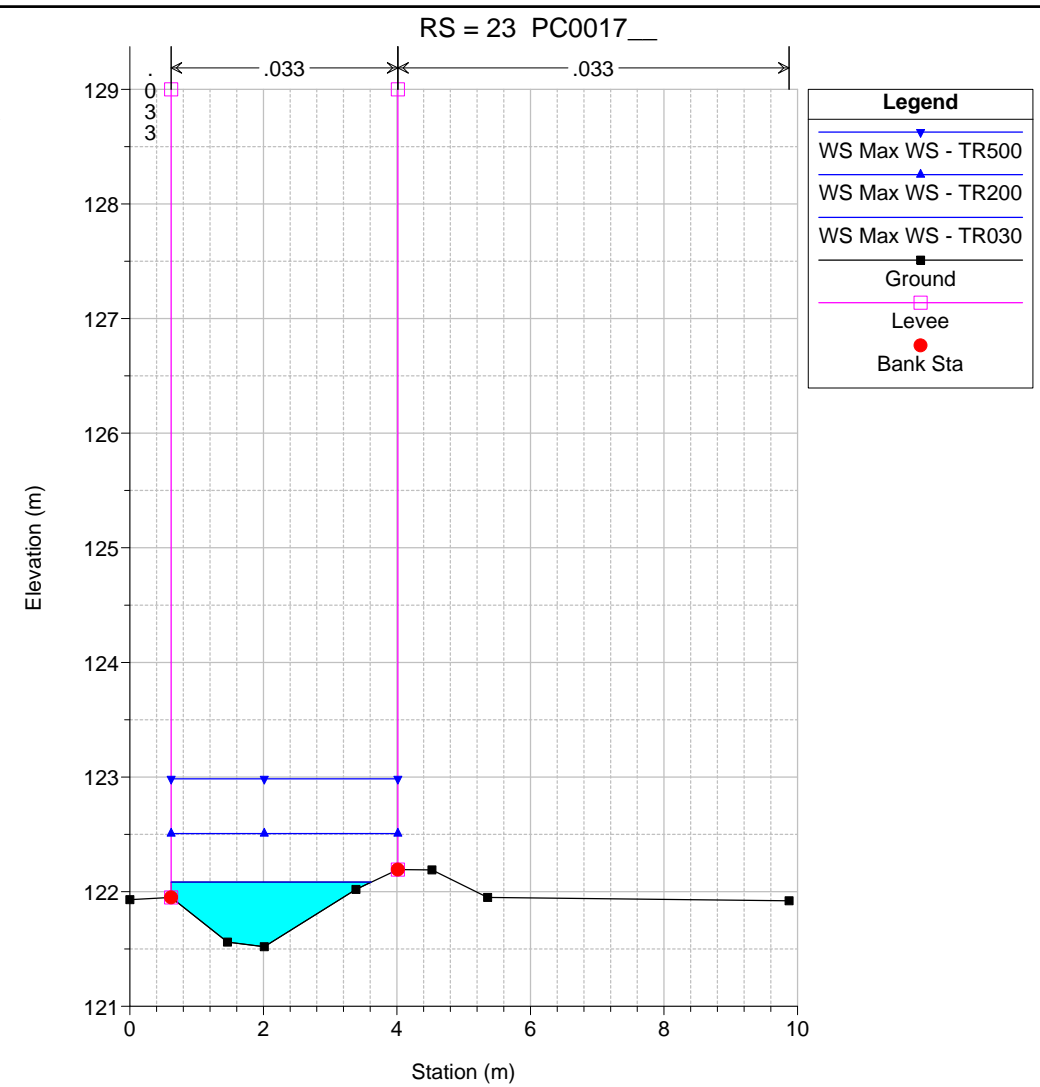
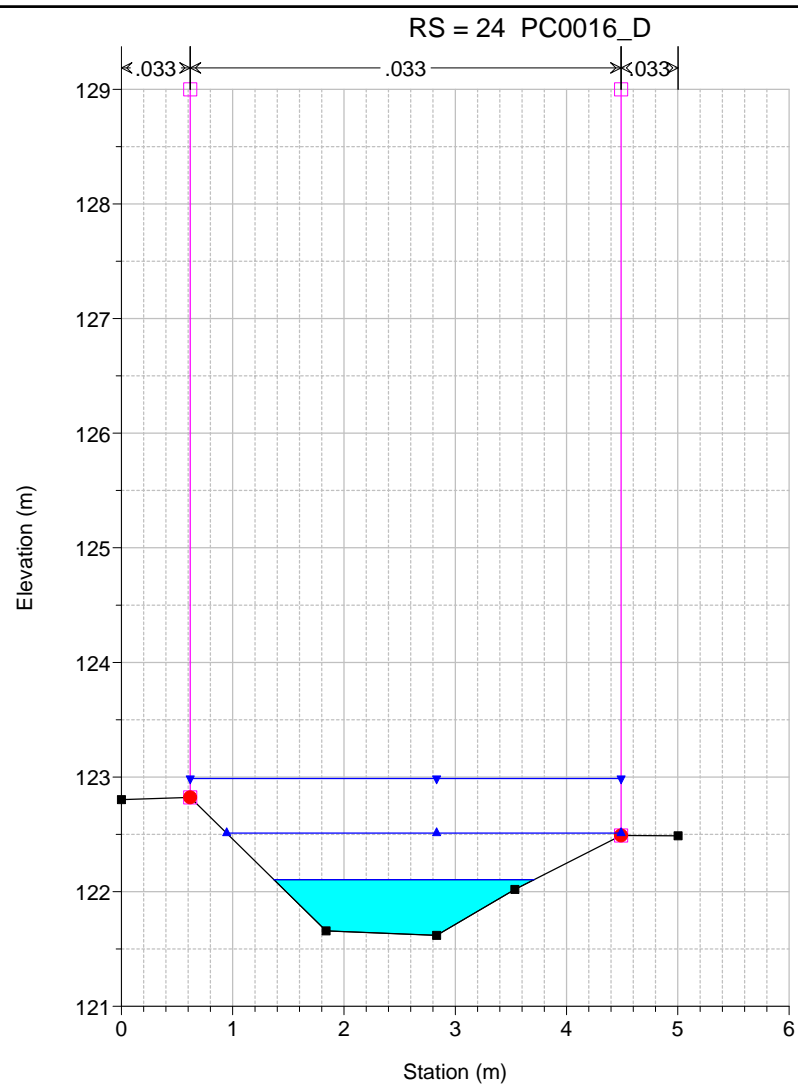
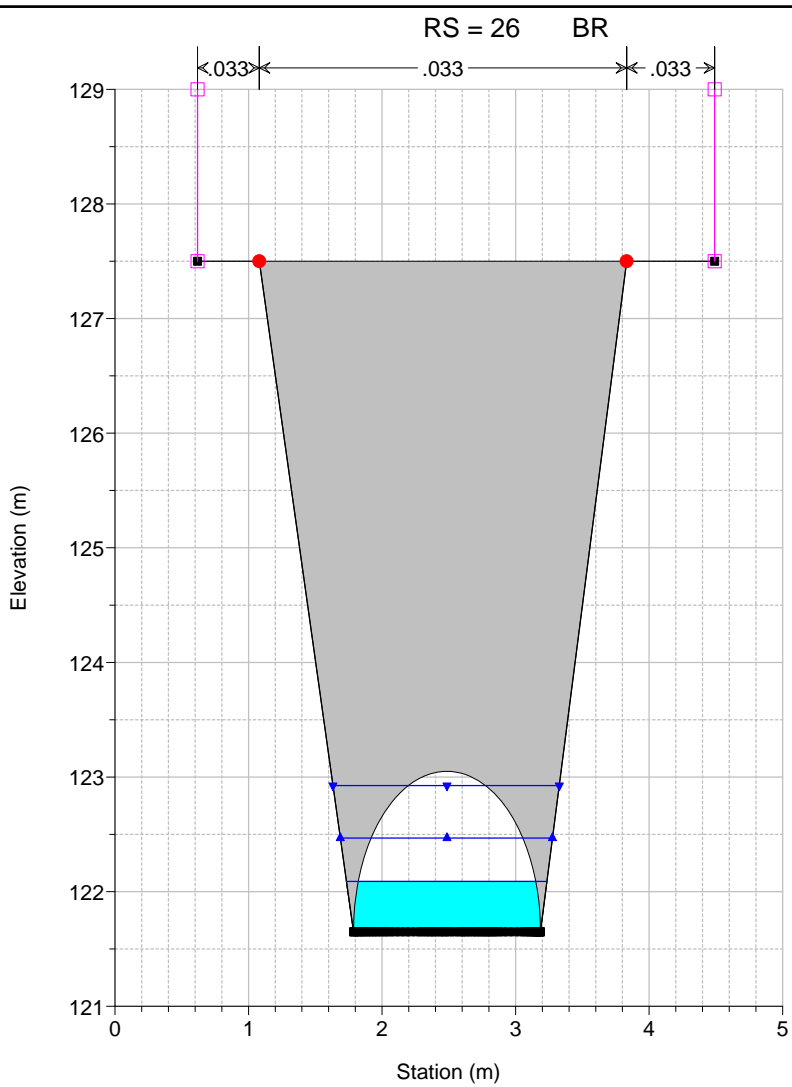

RS = 19 PC0018_D

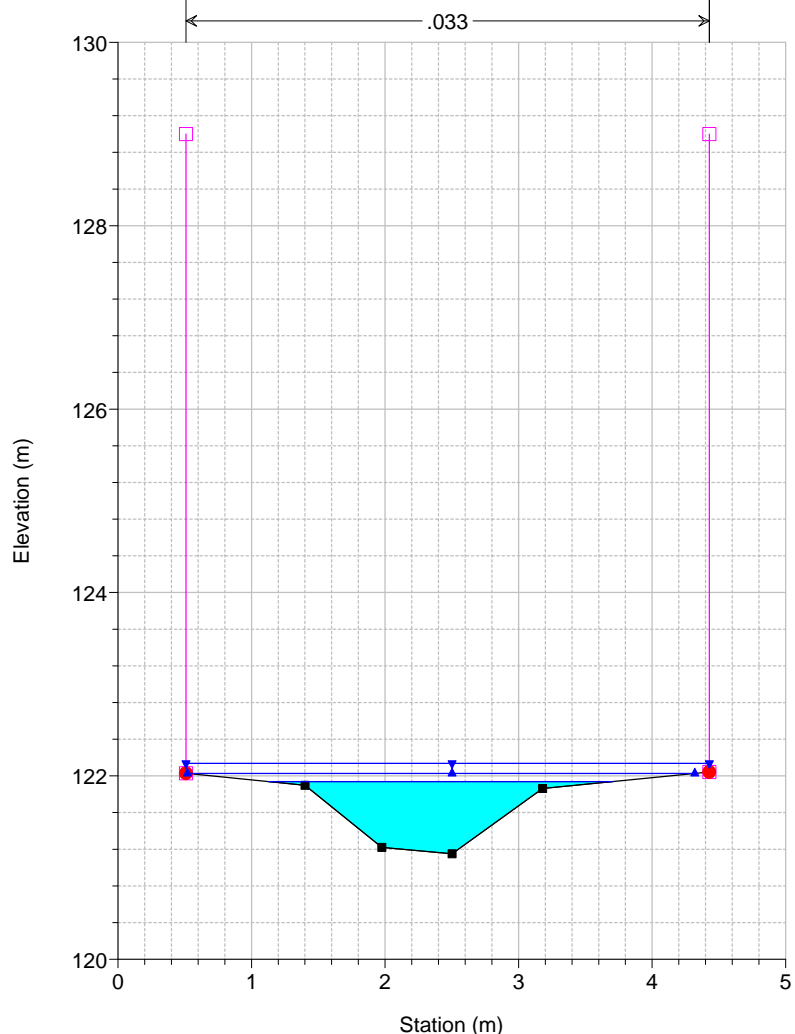

Legend

- WS Max WS - TR500
- WS Max WS - TR200
- WS Max WS - TR030
- Ground
- Levee
- Bank Sta

RS = 18 PC0019_A

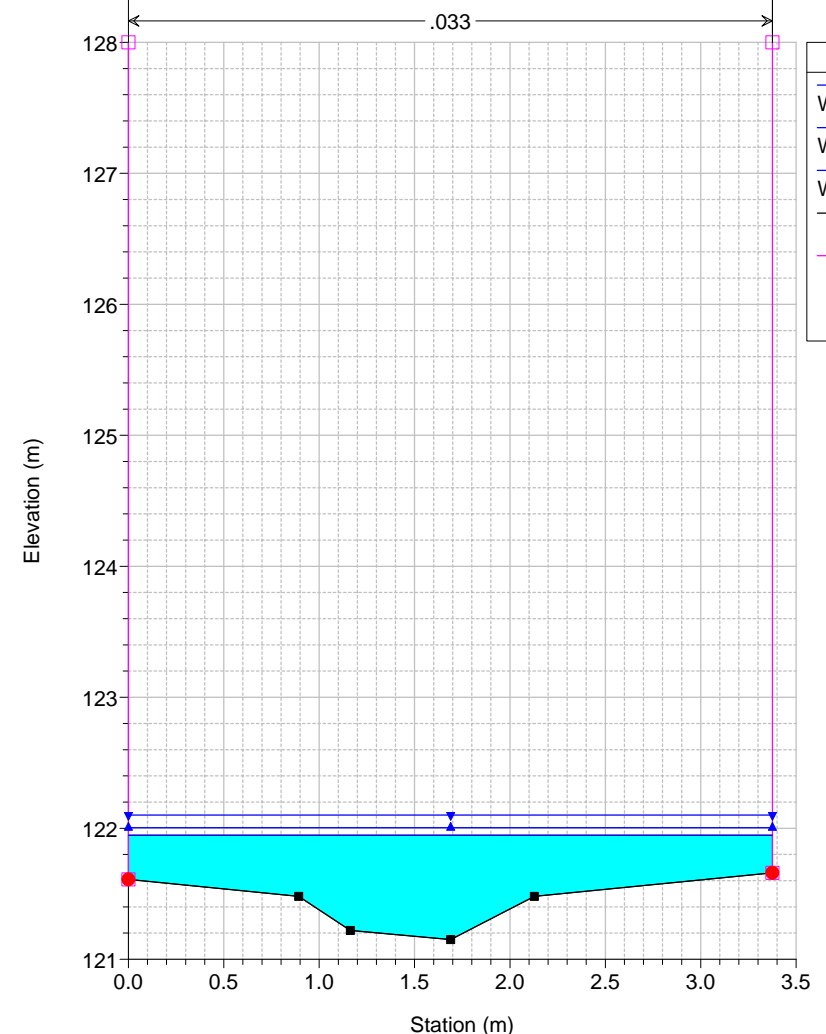

Legend

- WS Max WS - TR500
- WS Max WS - TR200
- WS Max WS - TR030
- Ground
- Levee
- Bank Sta

RS = 17 BR

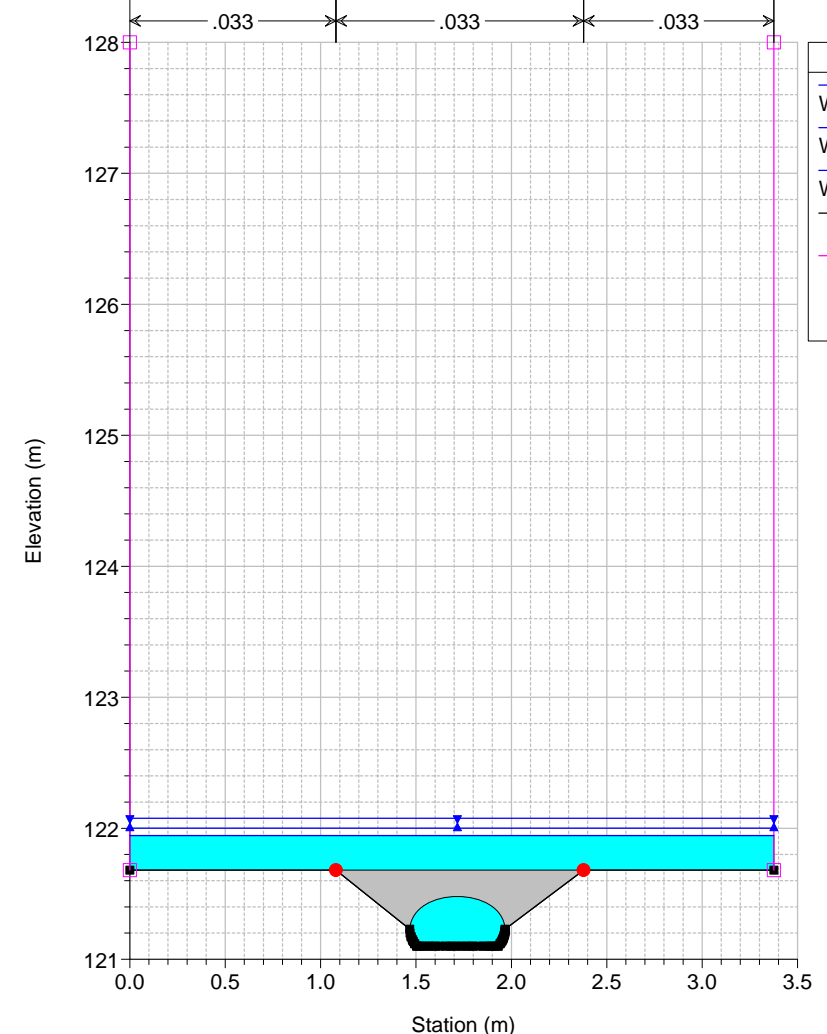

Legend

- WS Max WS - TR500
- WS Max WS - TR200
- WS Max WS - TR030
- Ground
- Levee
- Bank Sta

RS = 17 BR

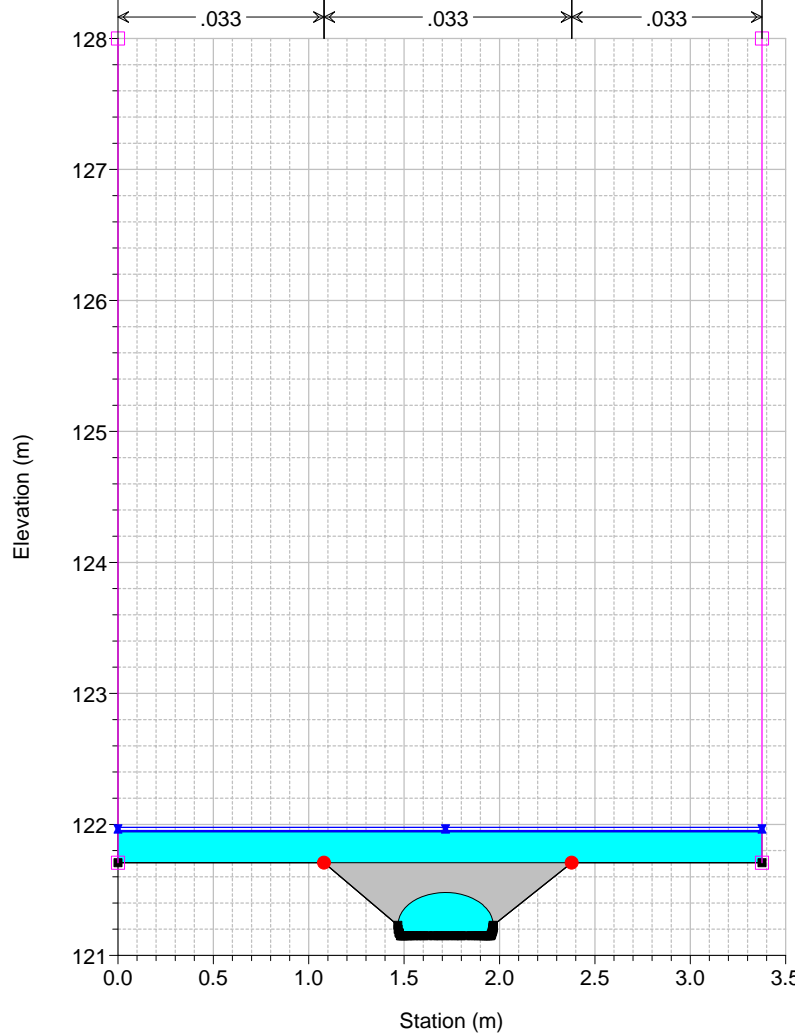

Legend

- WS Max WS - TR500
- WS Max WS - TR200
- WS Max WS - TR030
- Ground
- Levee
- Bank Sta

RS = 15 PC0019_D

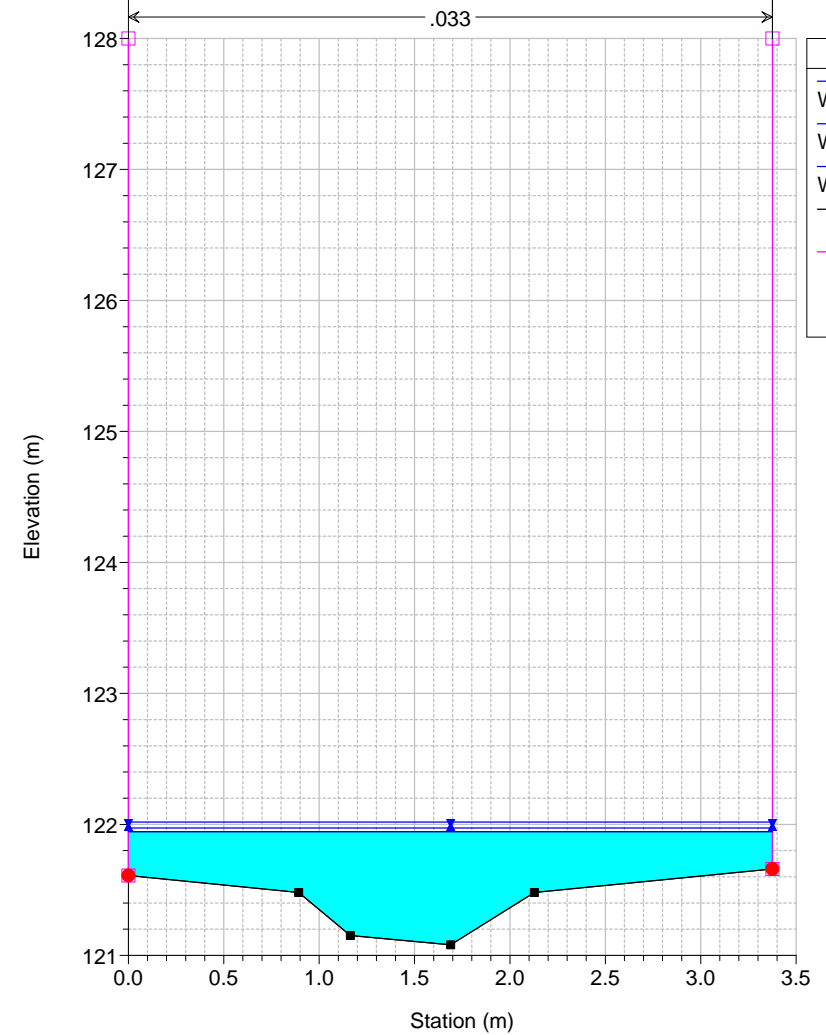

Legend

- WS Max WS - TR500
- WS Max WS - TR200
- WS Max WS - TR030
- Ground
- Levee
- Bank Sta

RS = 14 PC0020_A

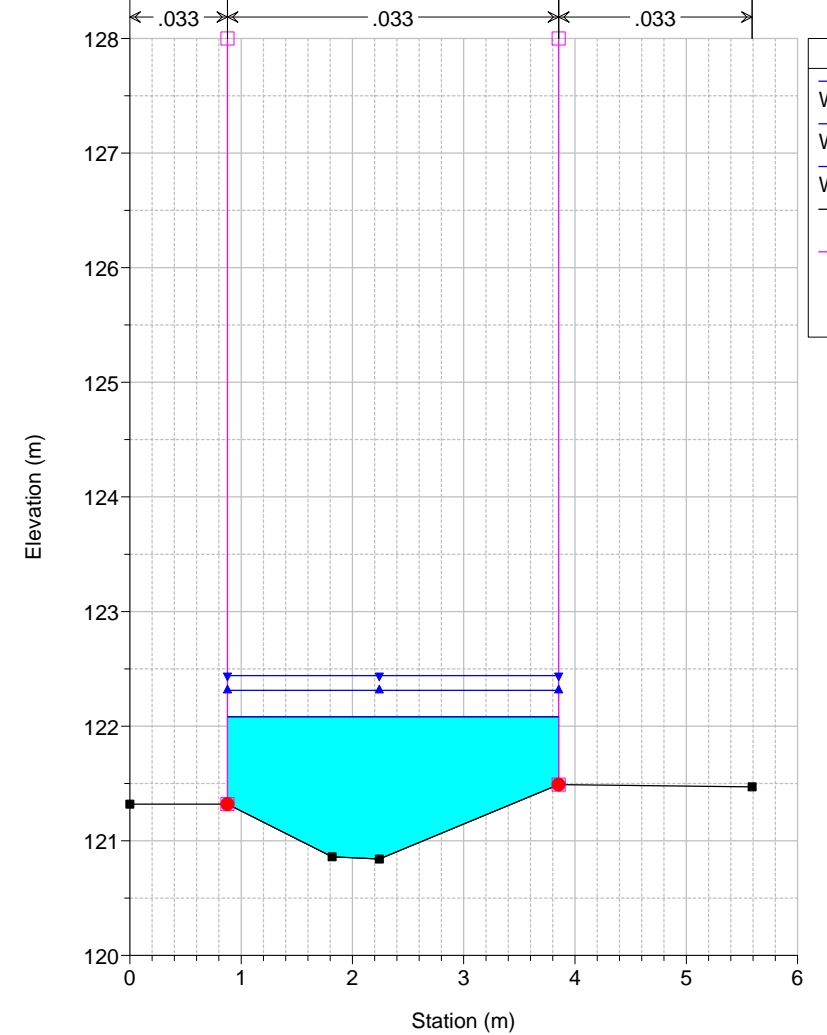

Legend

- WS Max WS - TR500
- WS Max WS - TR200
- WS Max WS - TR030
- Ground
- Levee
- Bank Sta

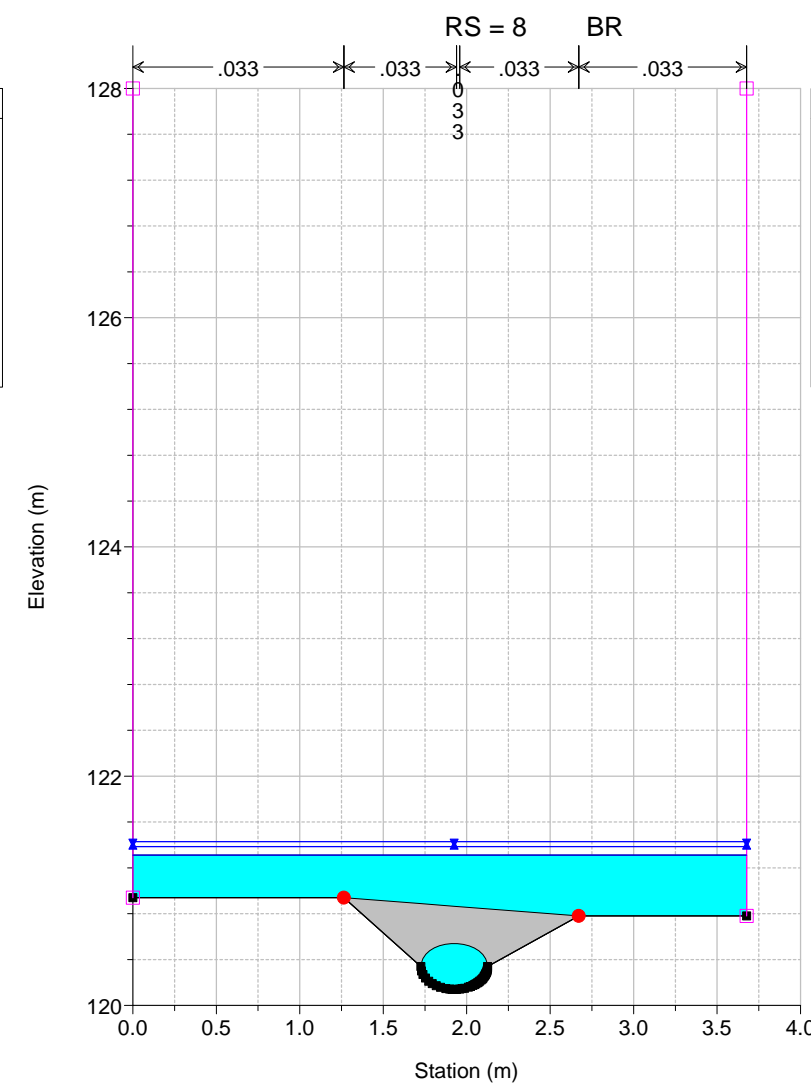
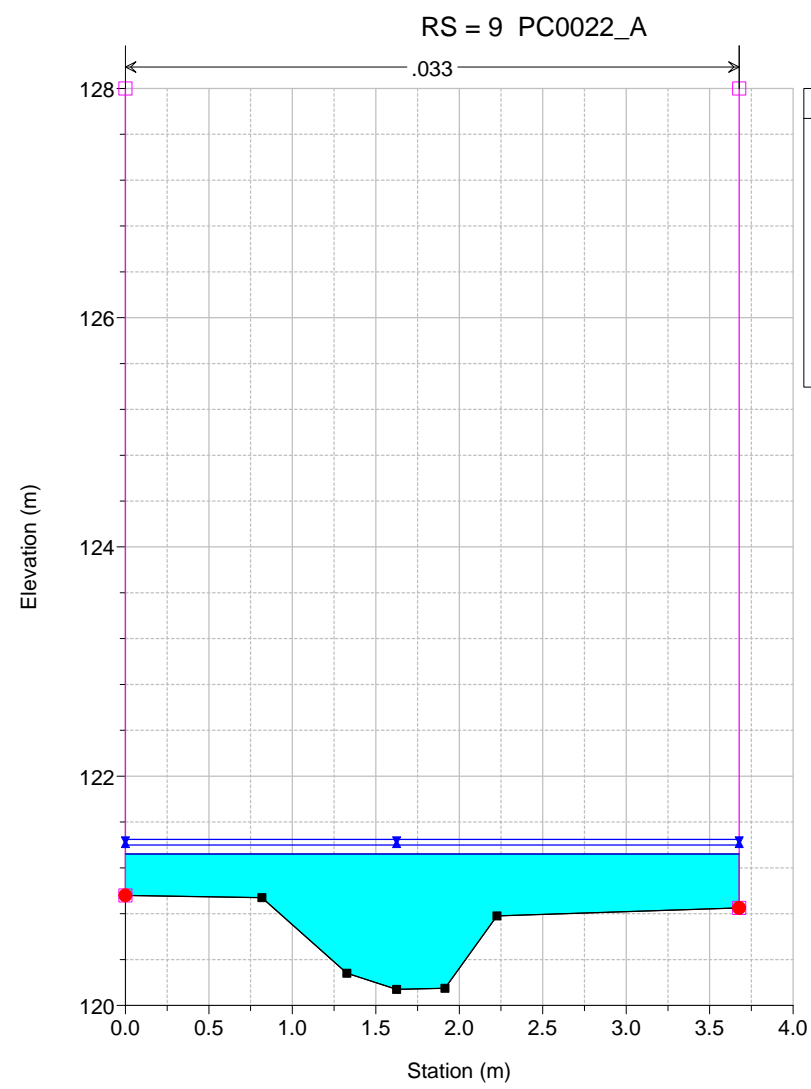
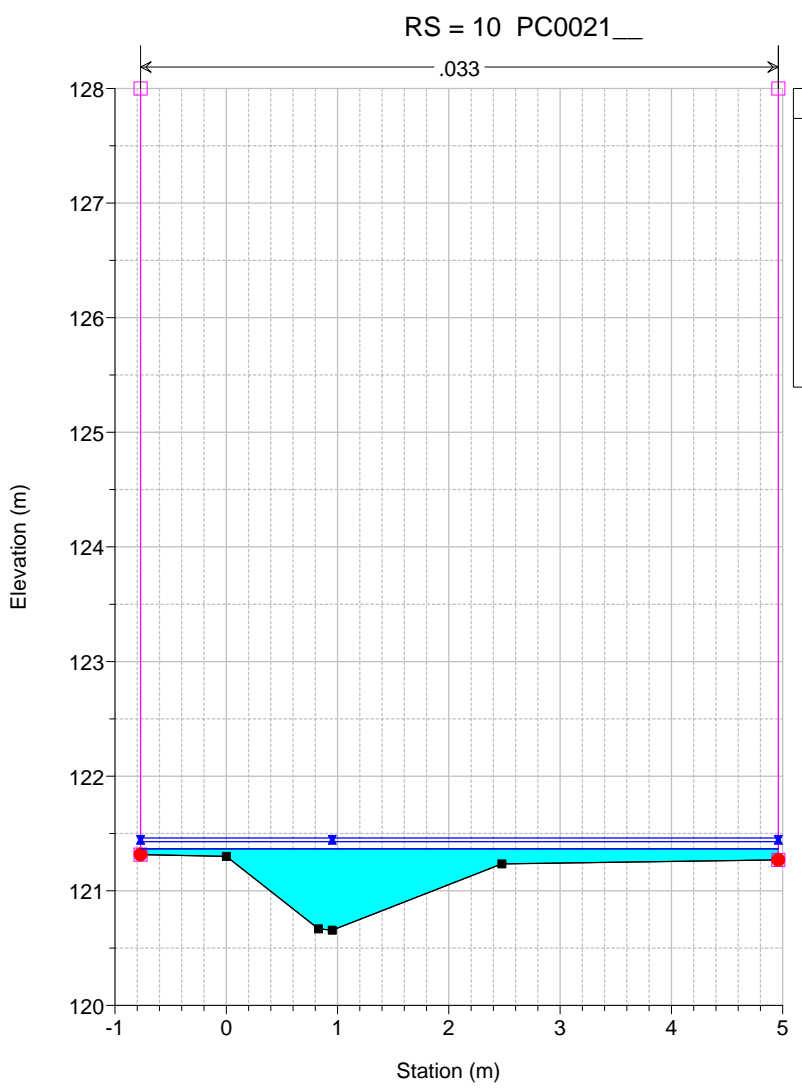
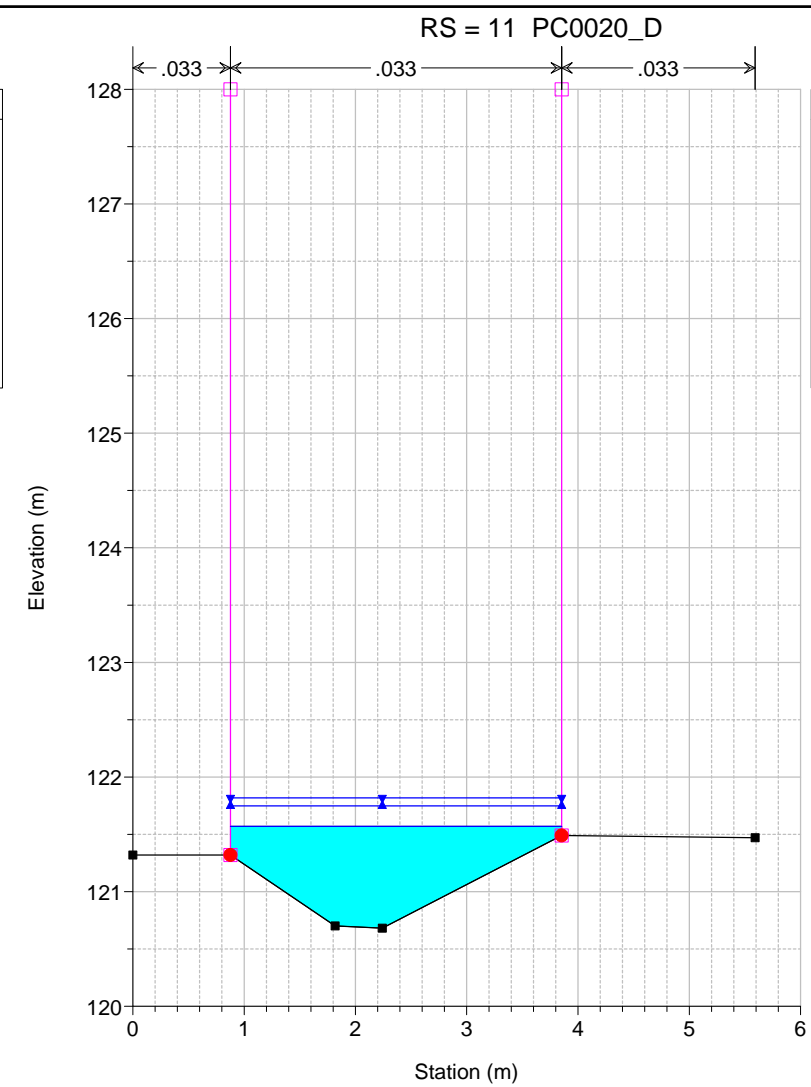
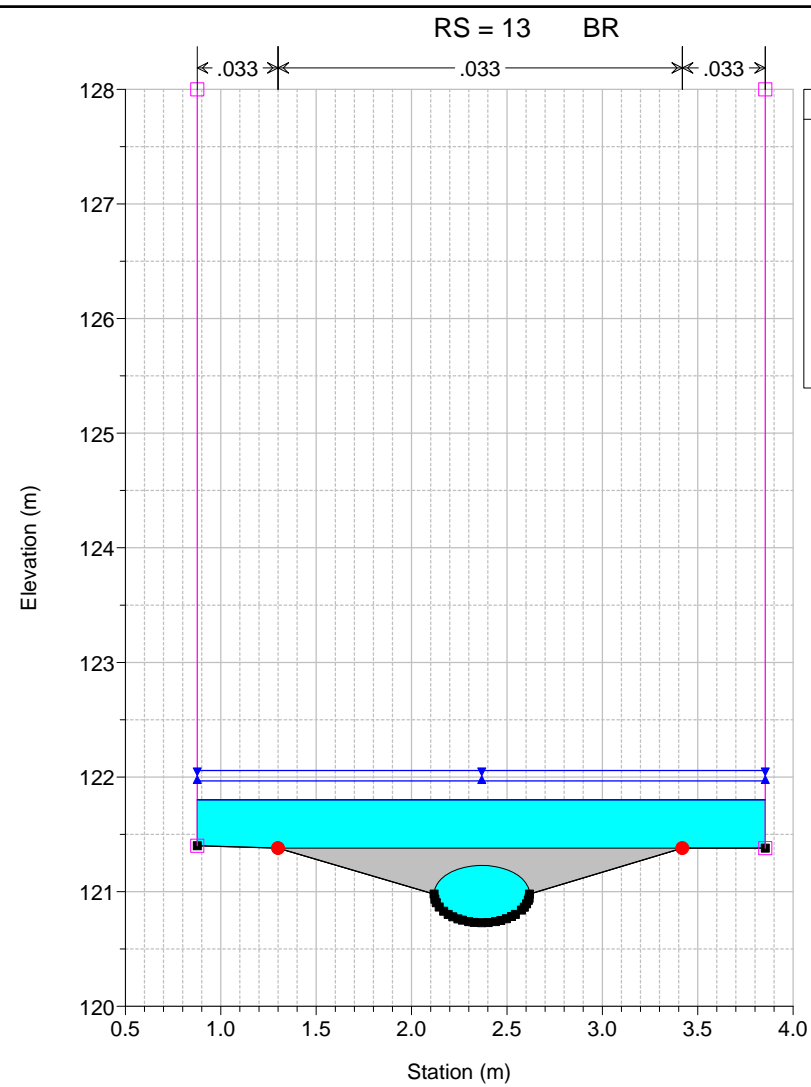
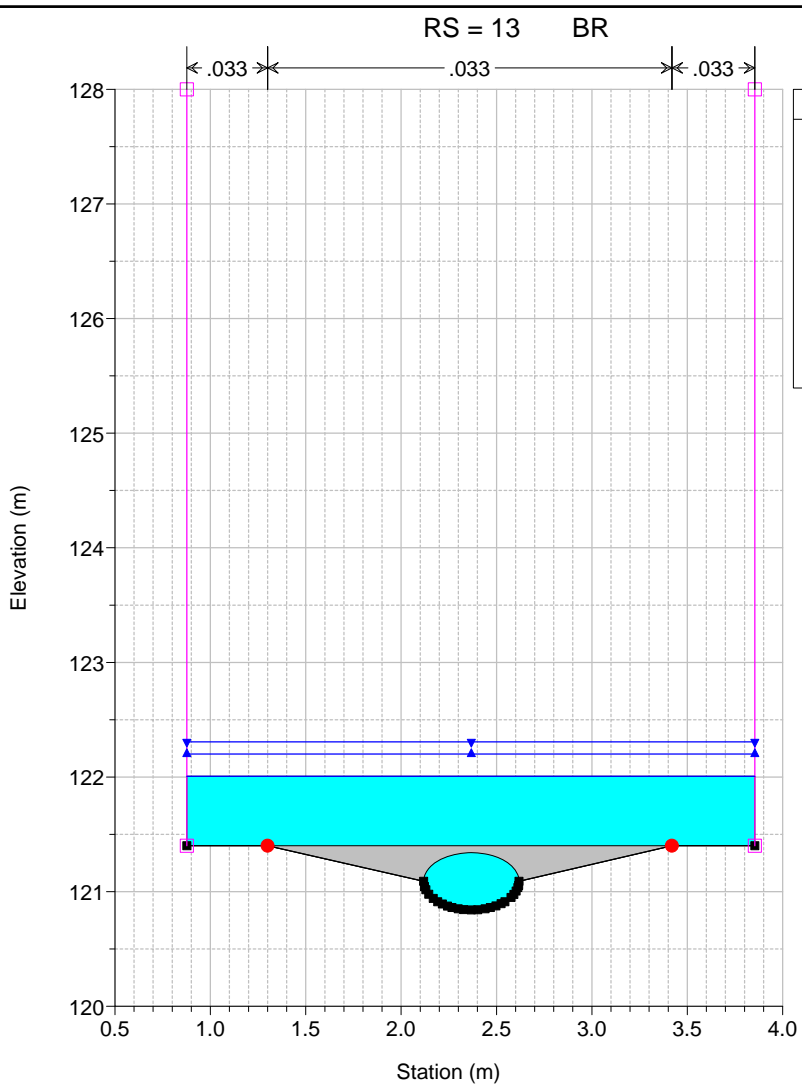

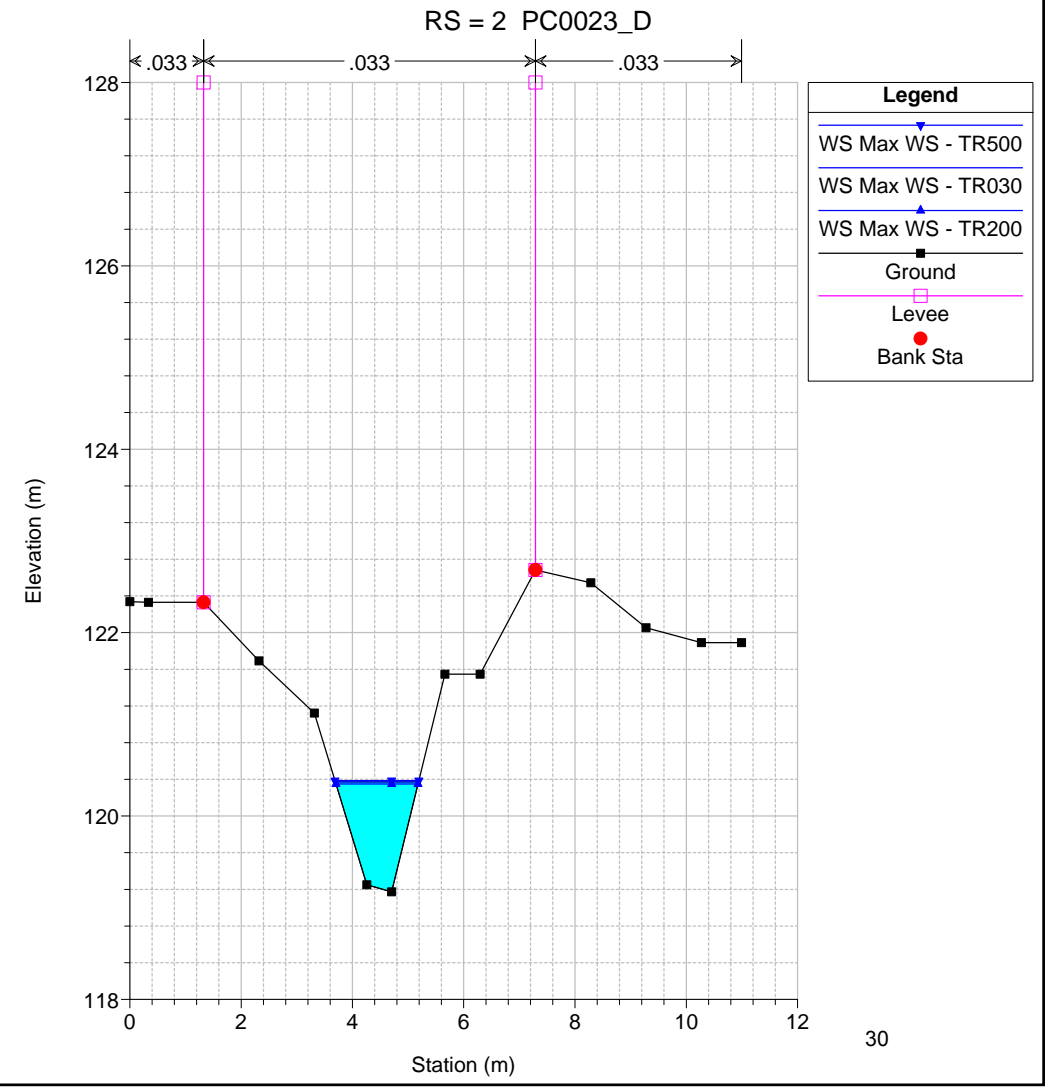
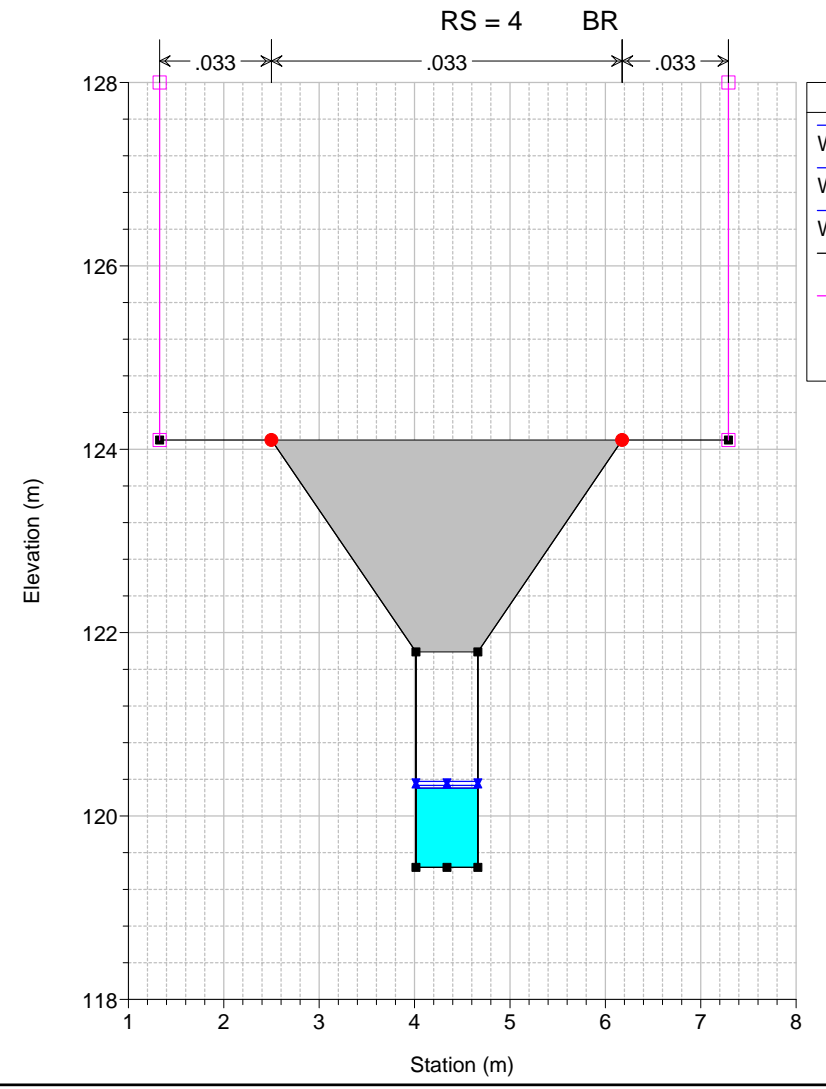
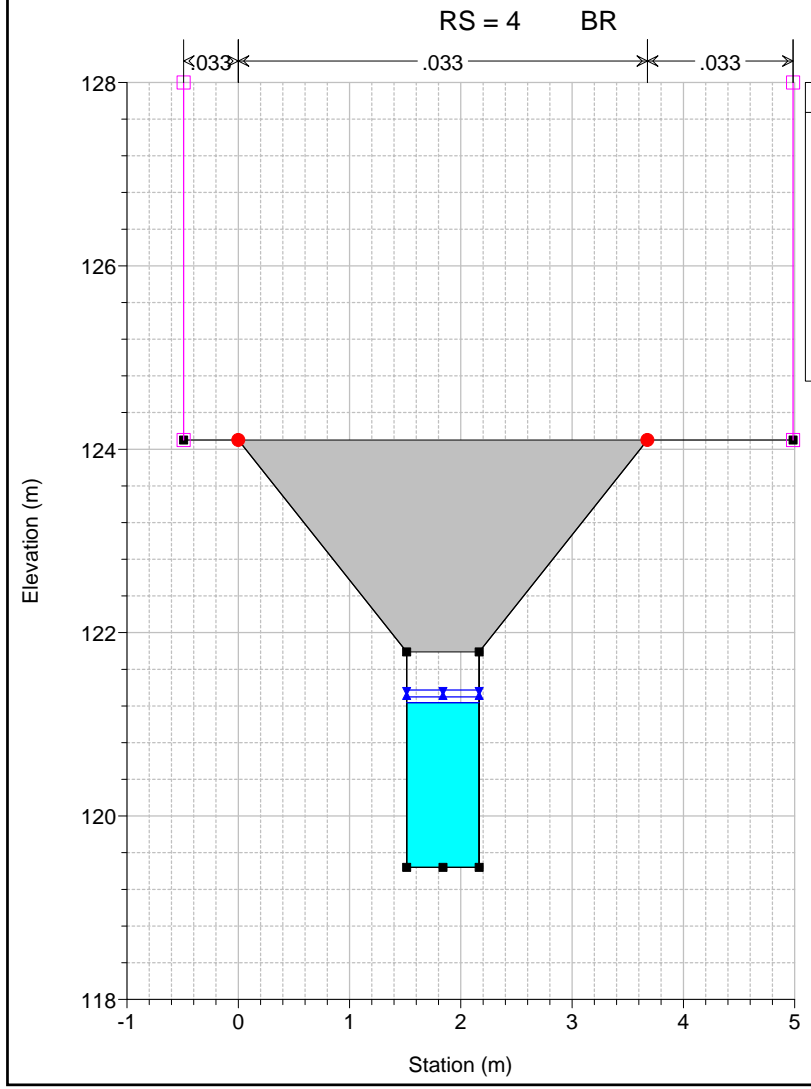
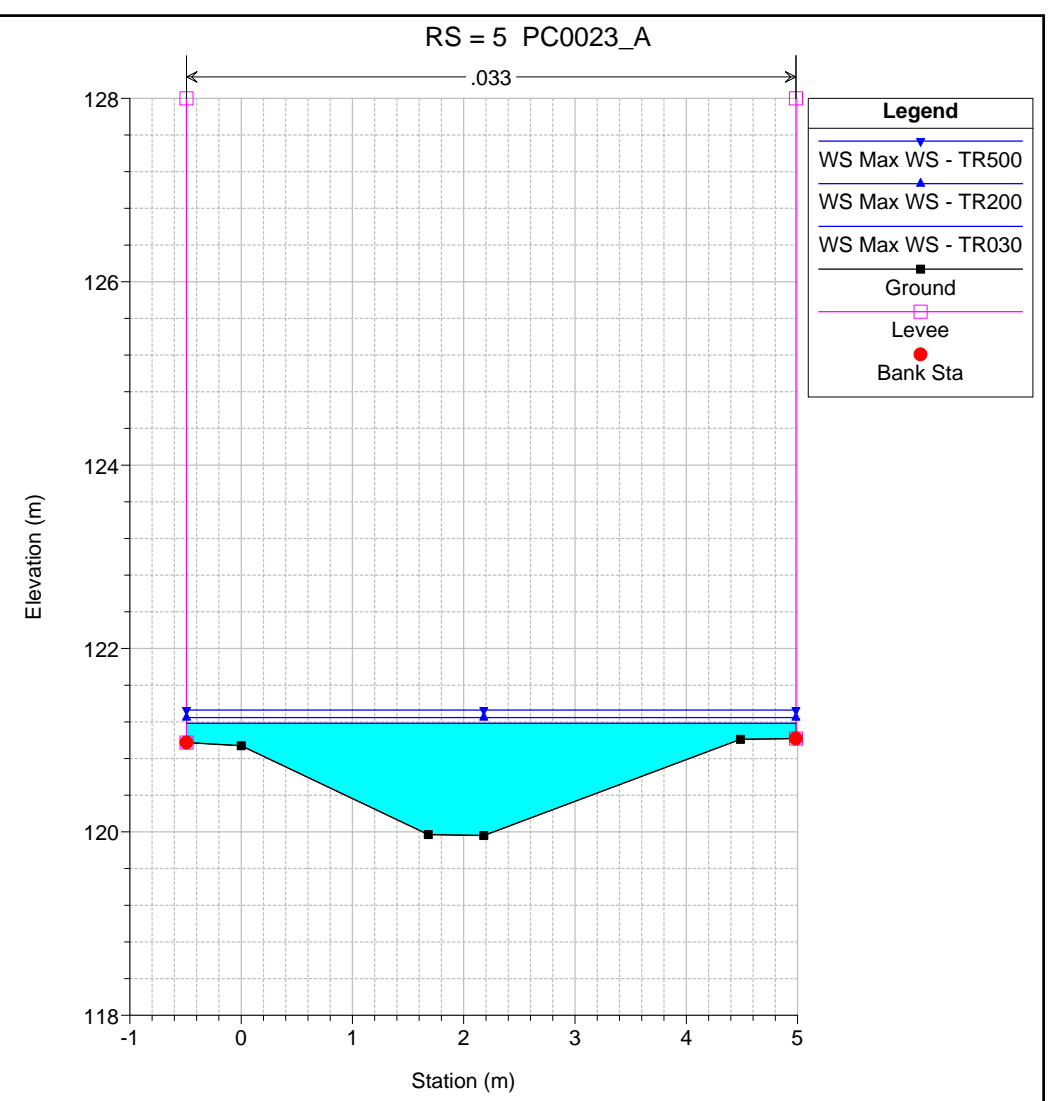
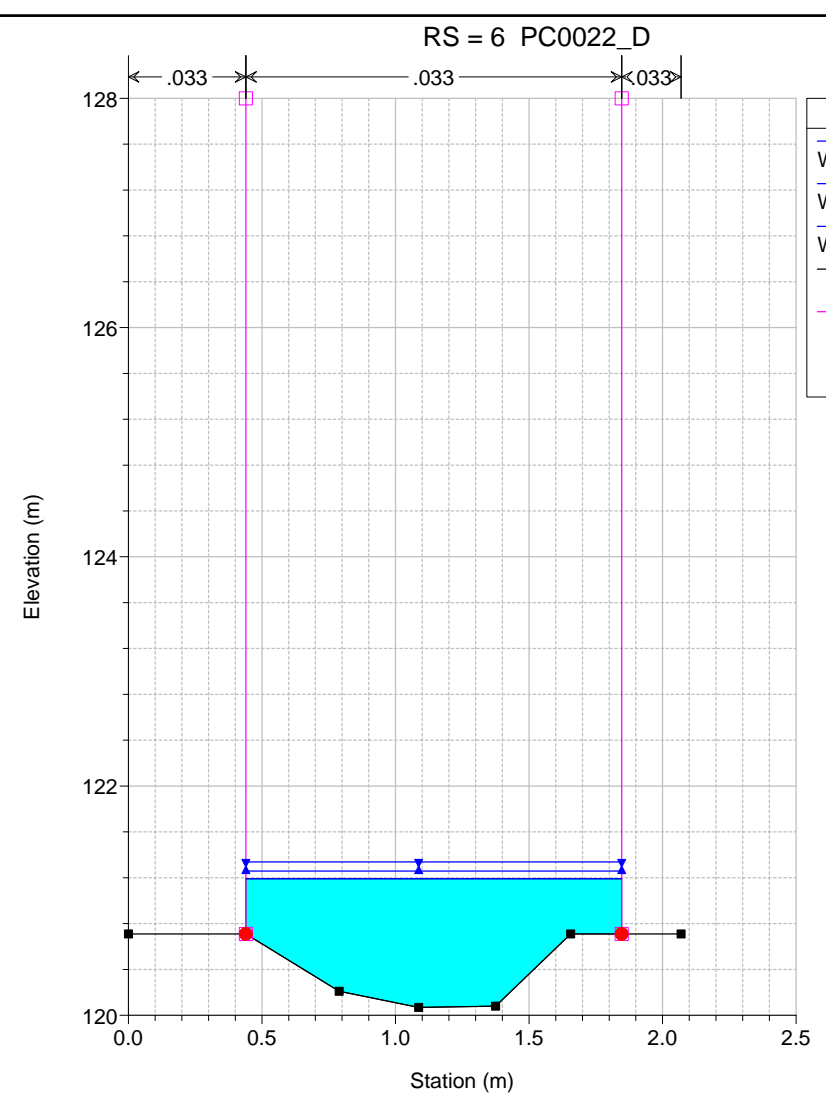
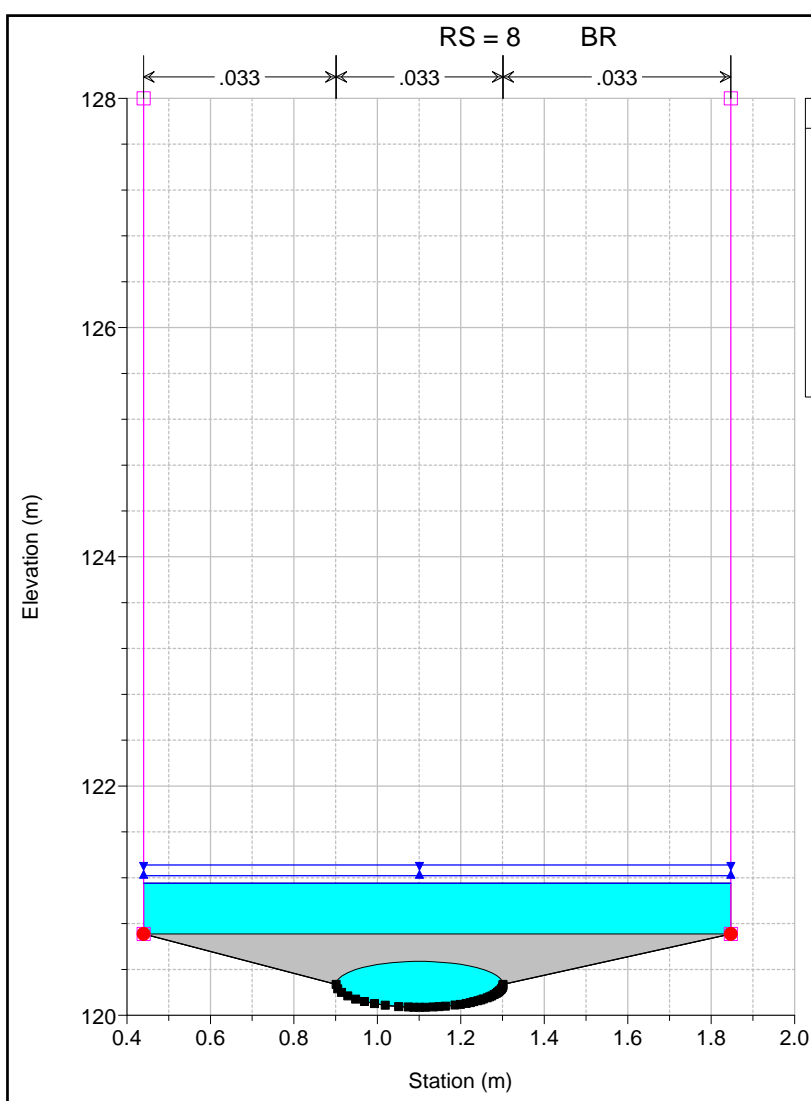

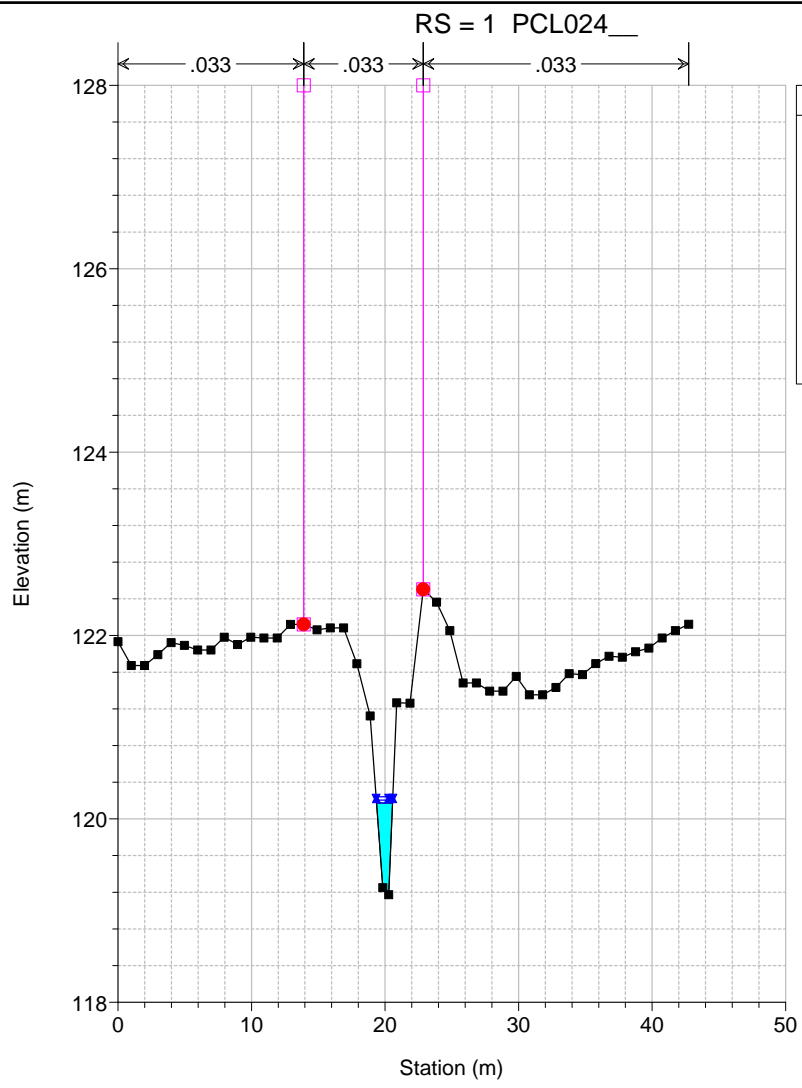

Sezioni fluviali
Borro Colmate, tratto a monte della confluenza con il diversivo
Tempo di ritorno: 30, 200 e 500 anni

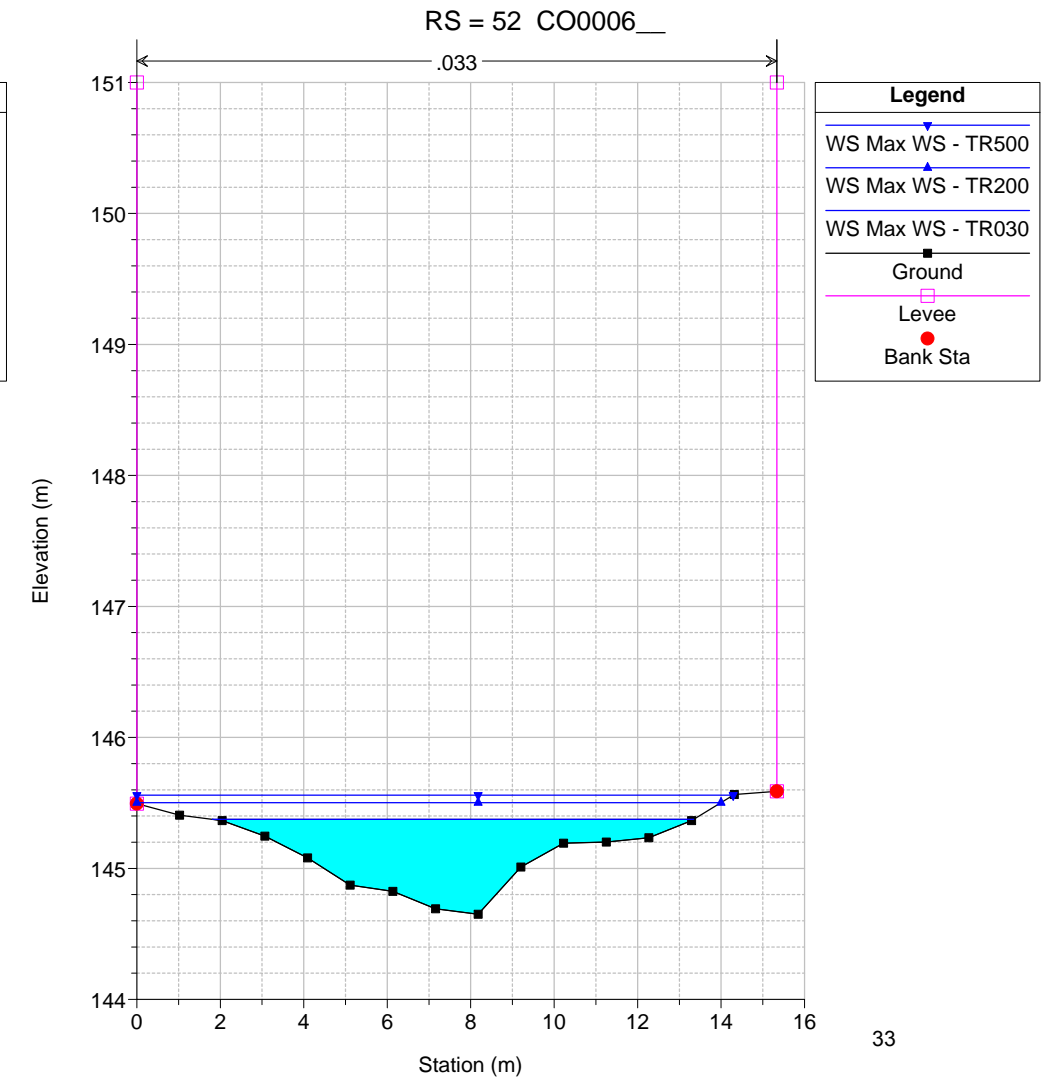
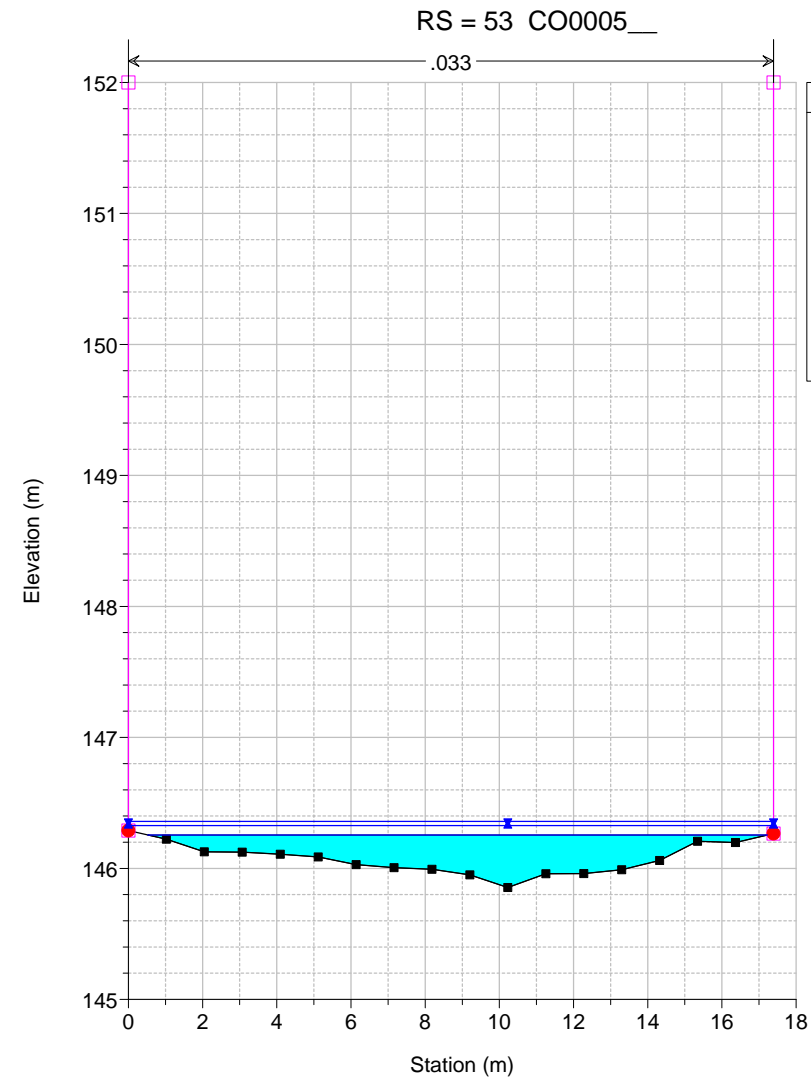
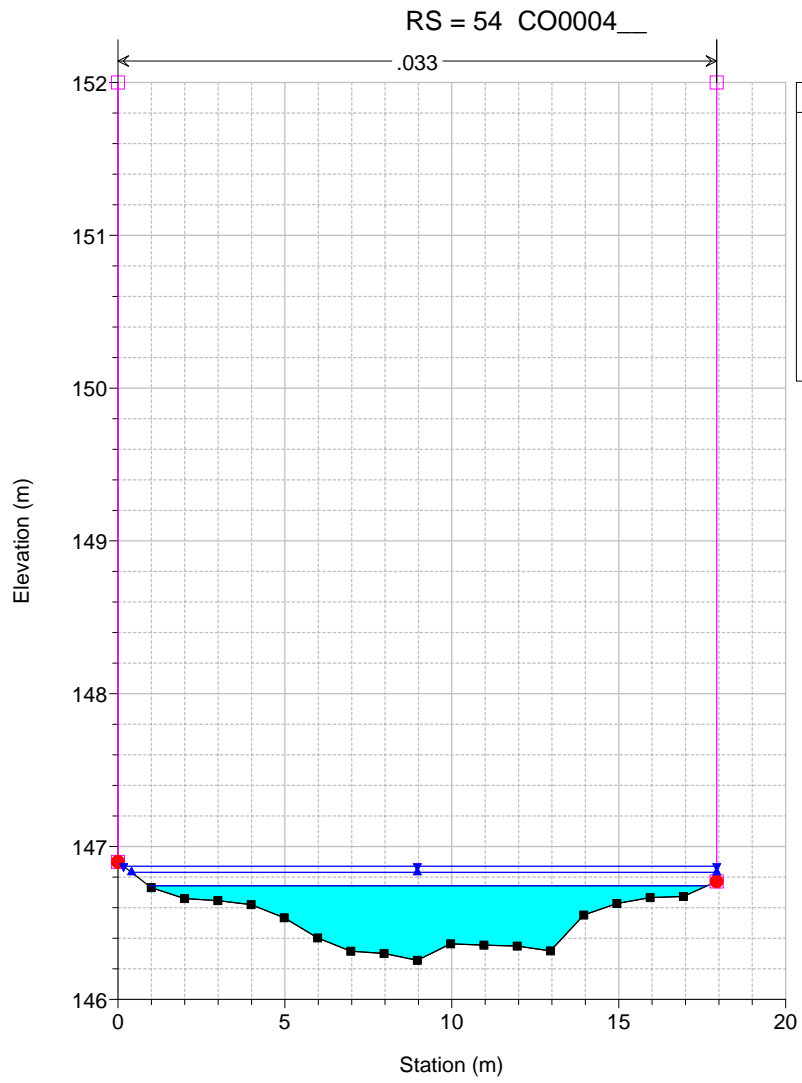
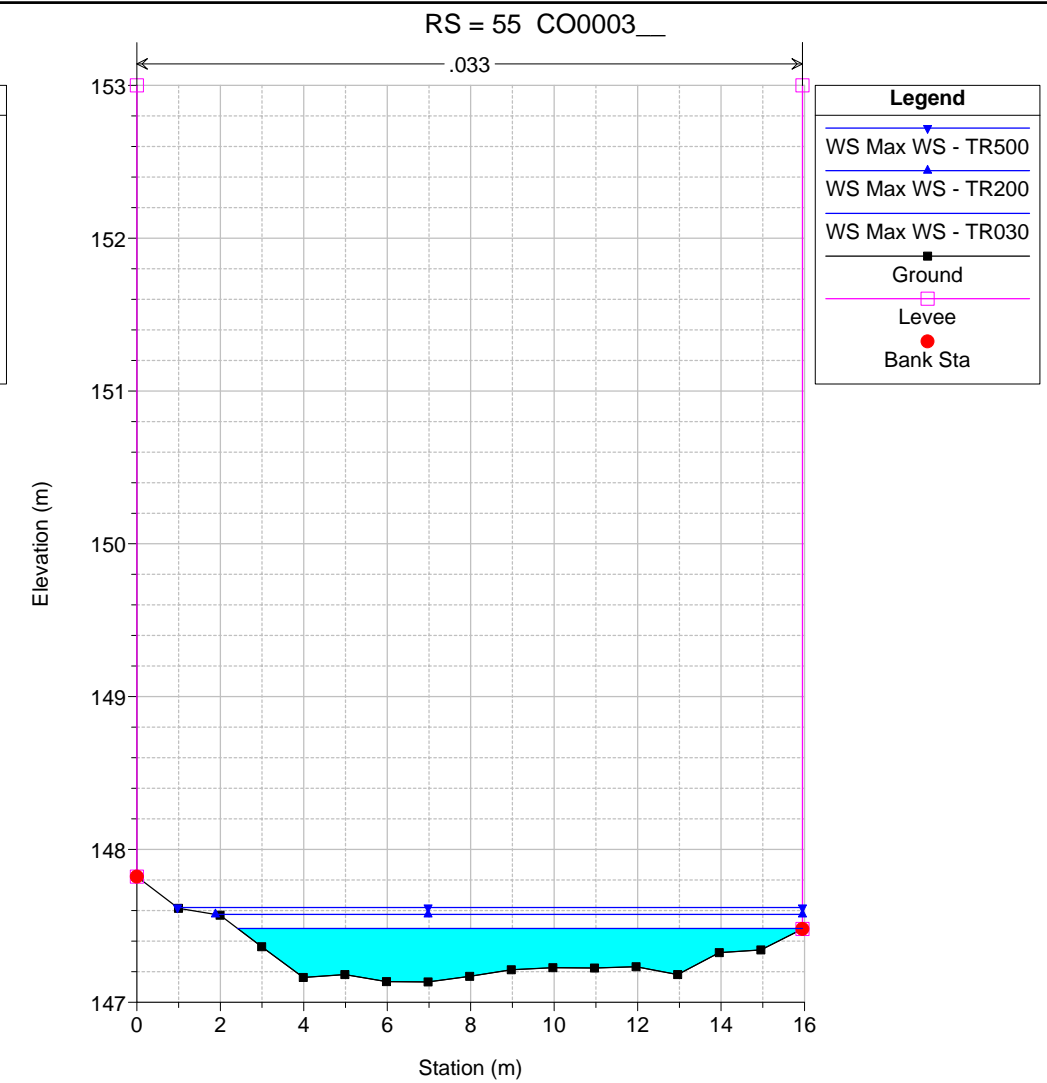
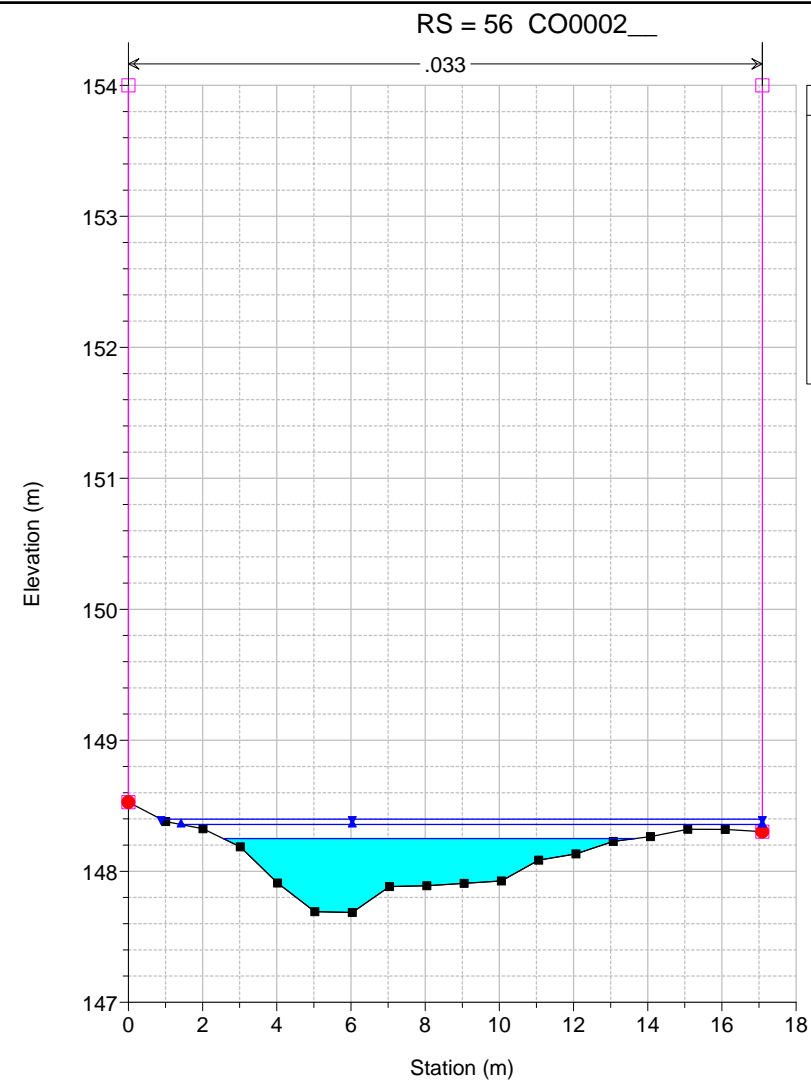
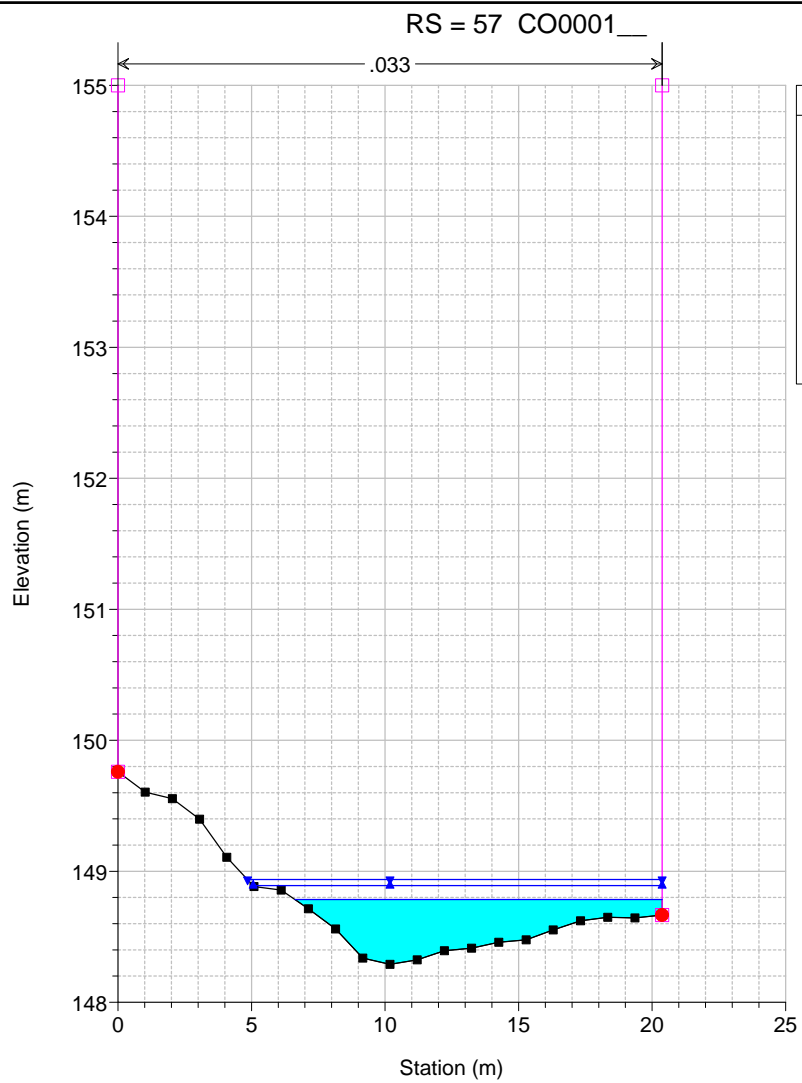

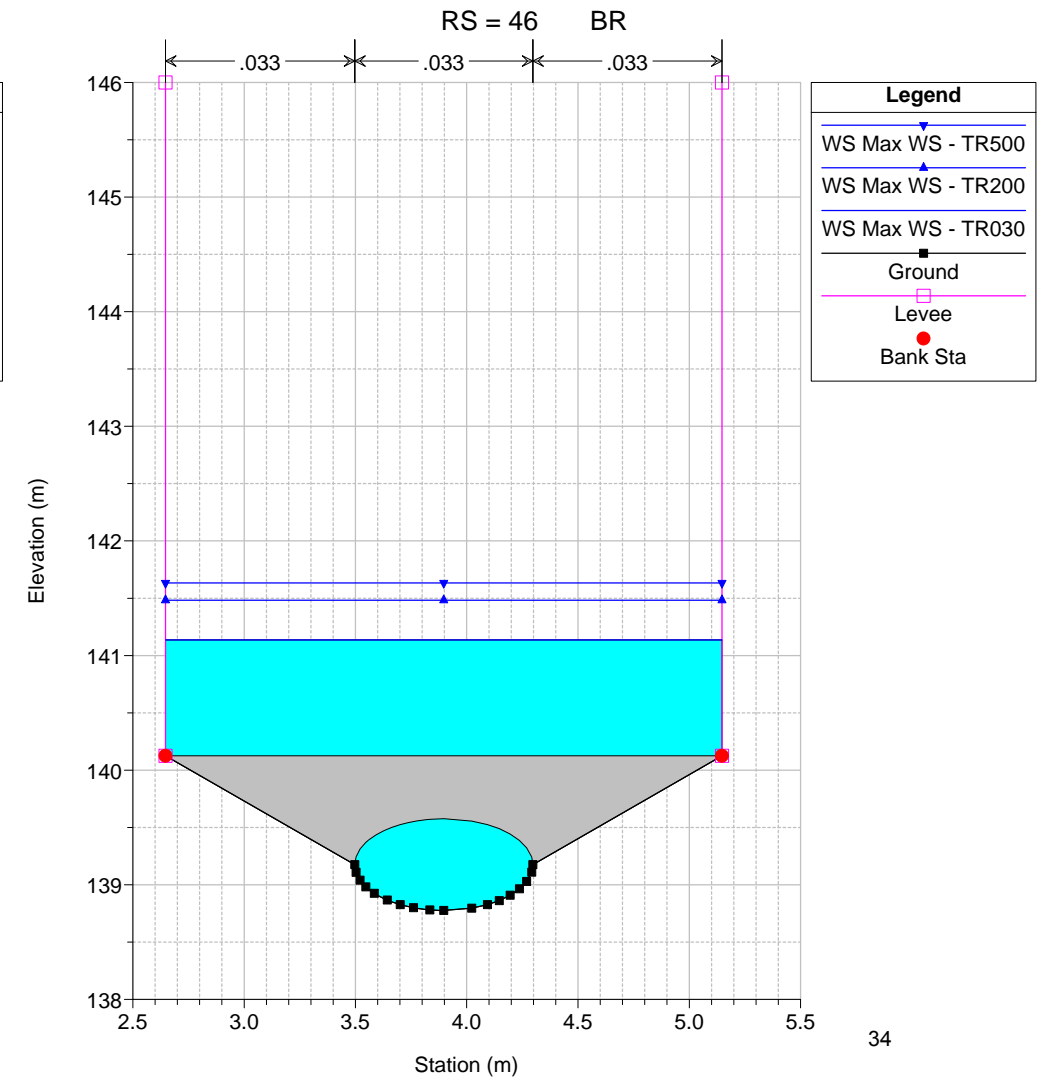
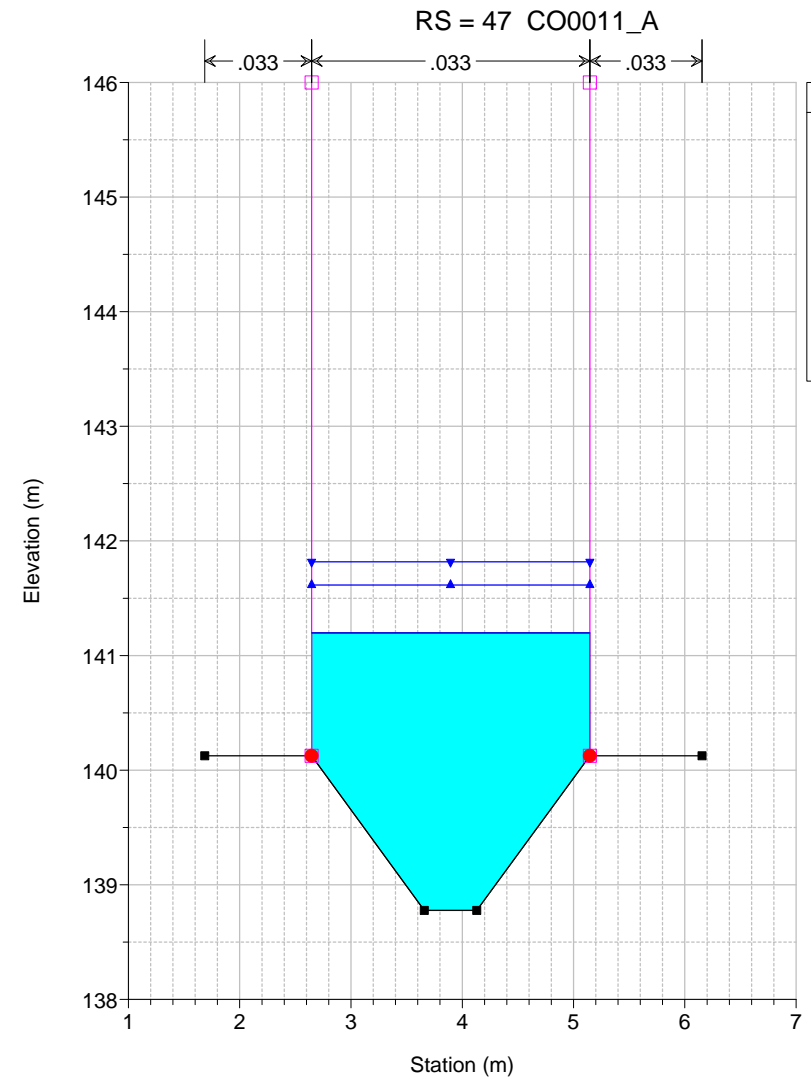
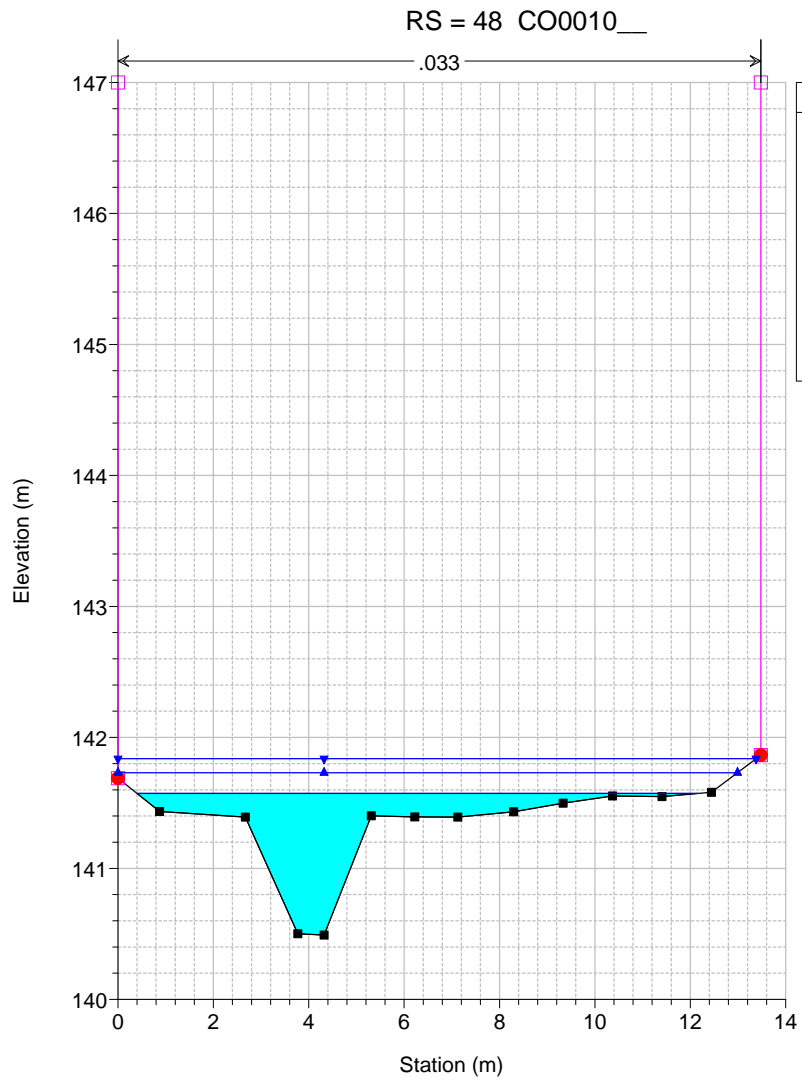
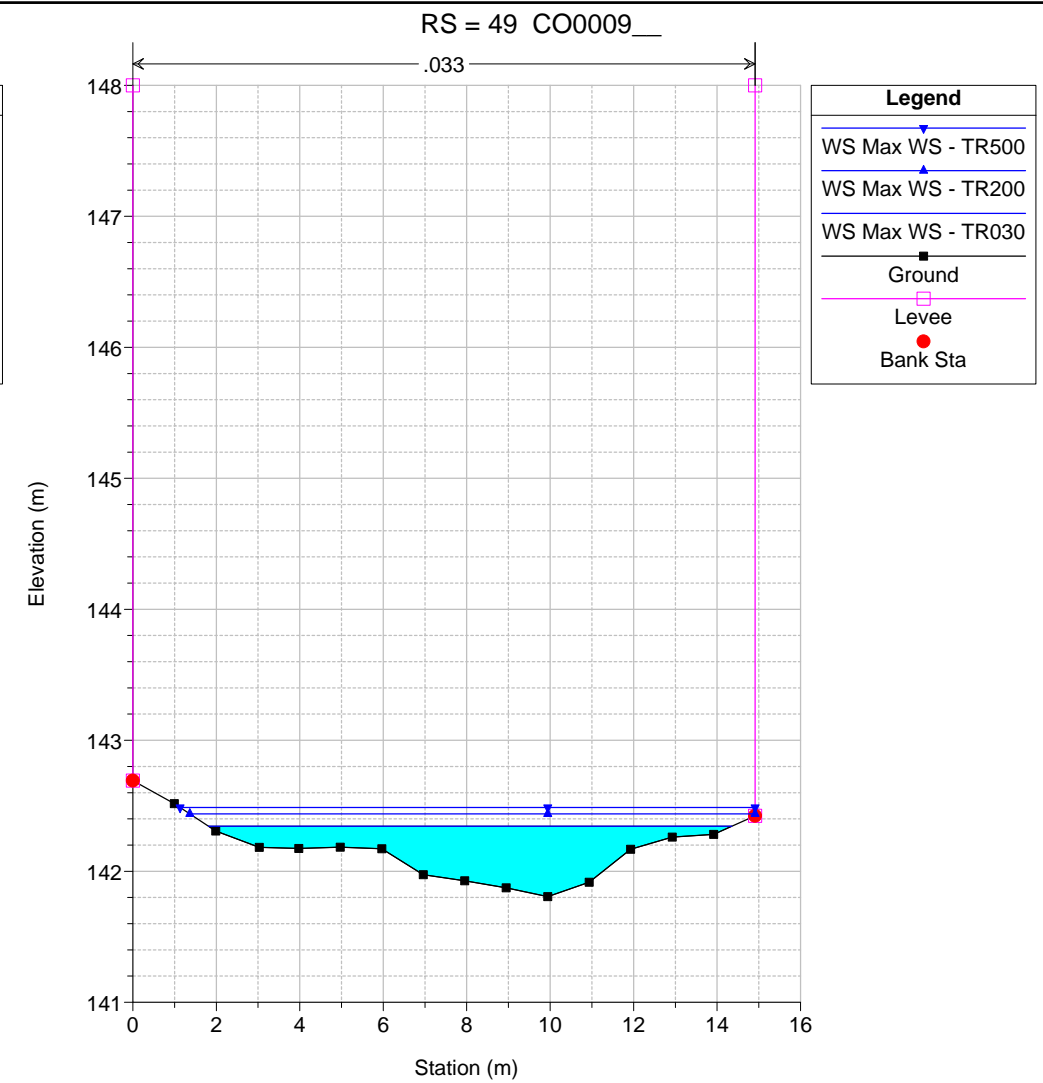
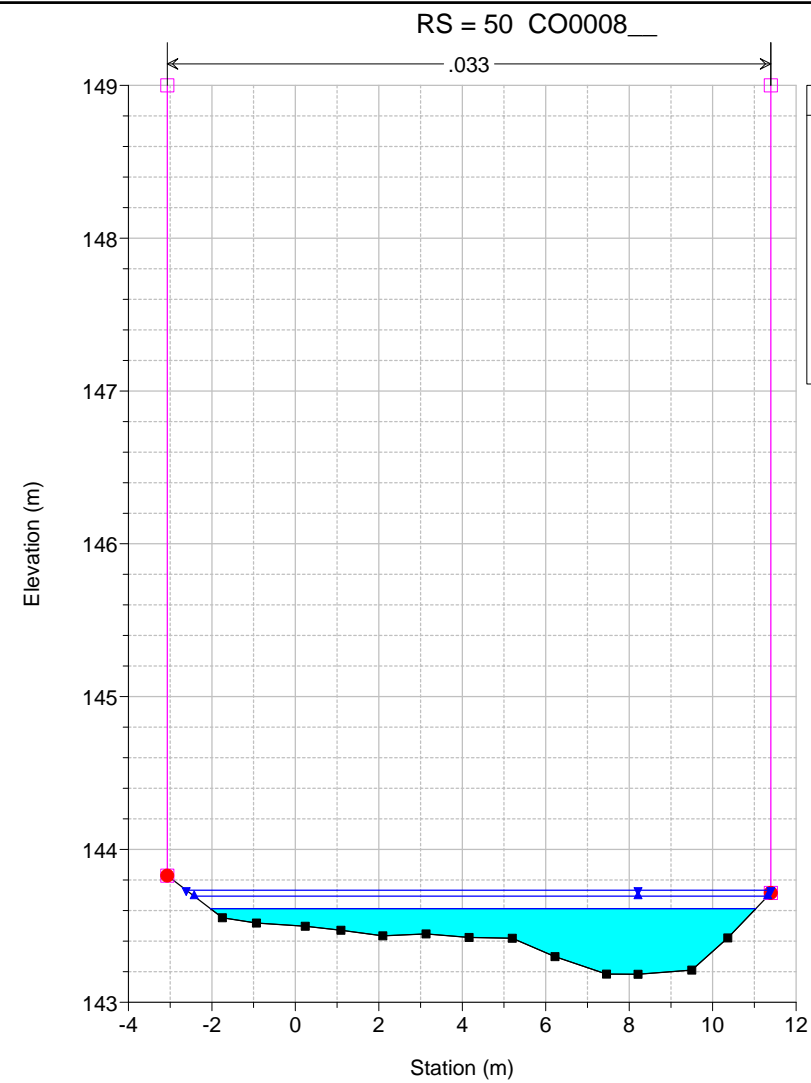
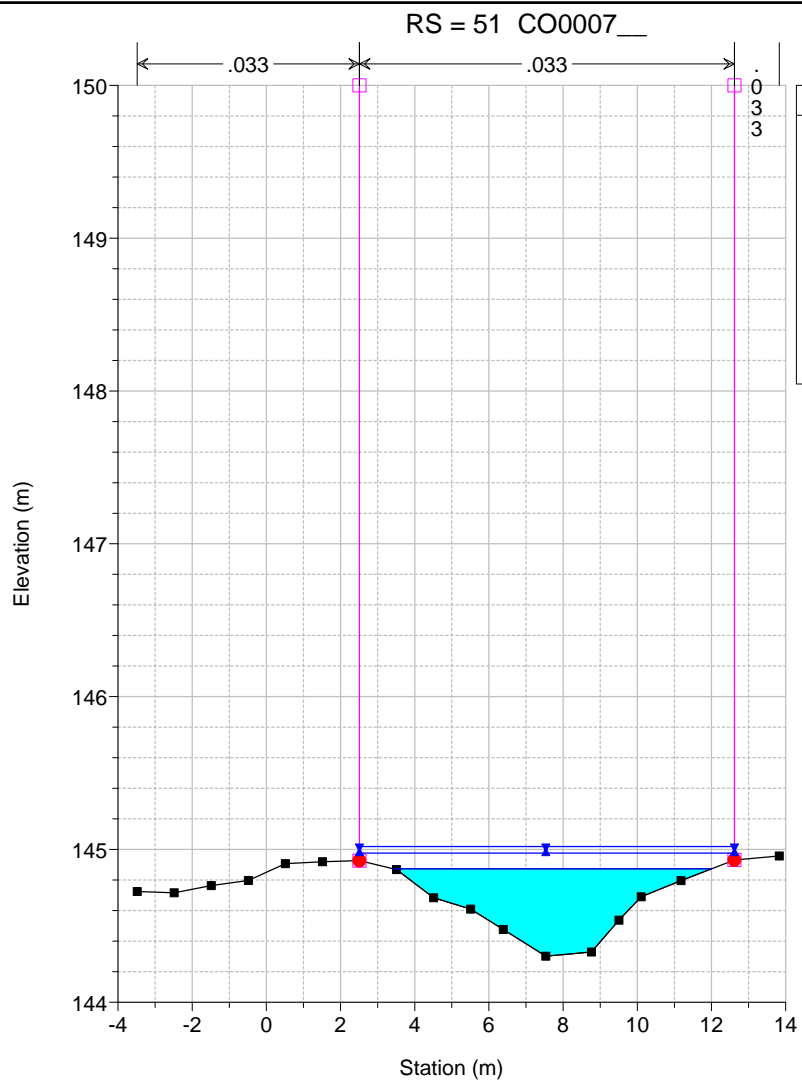

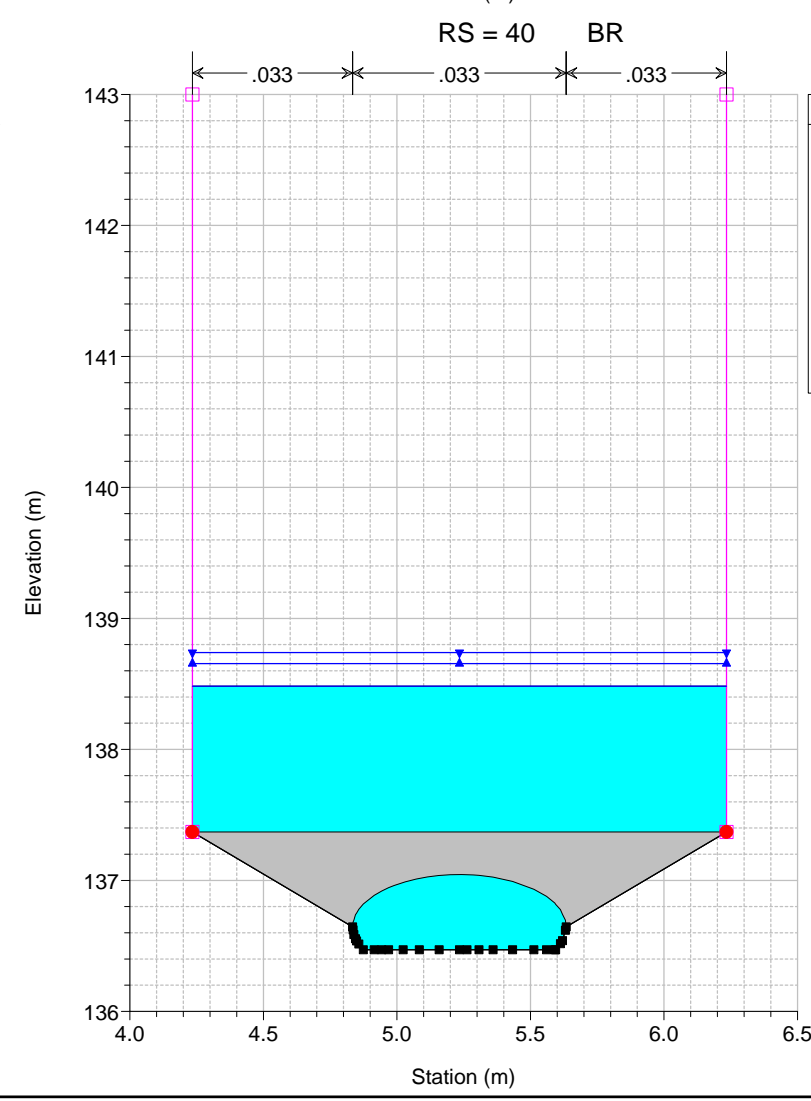
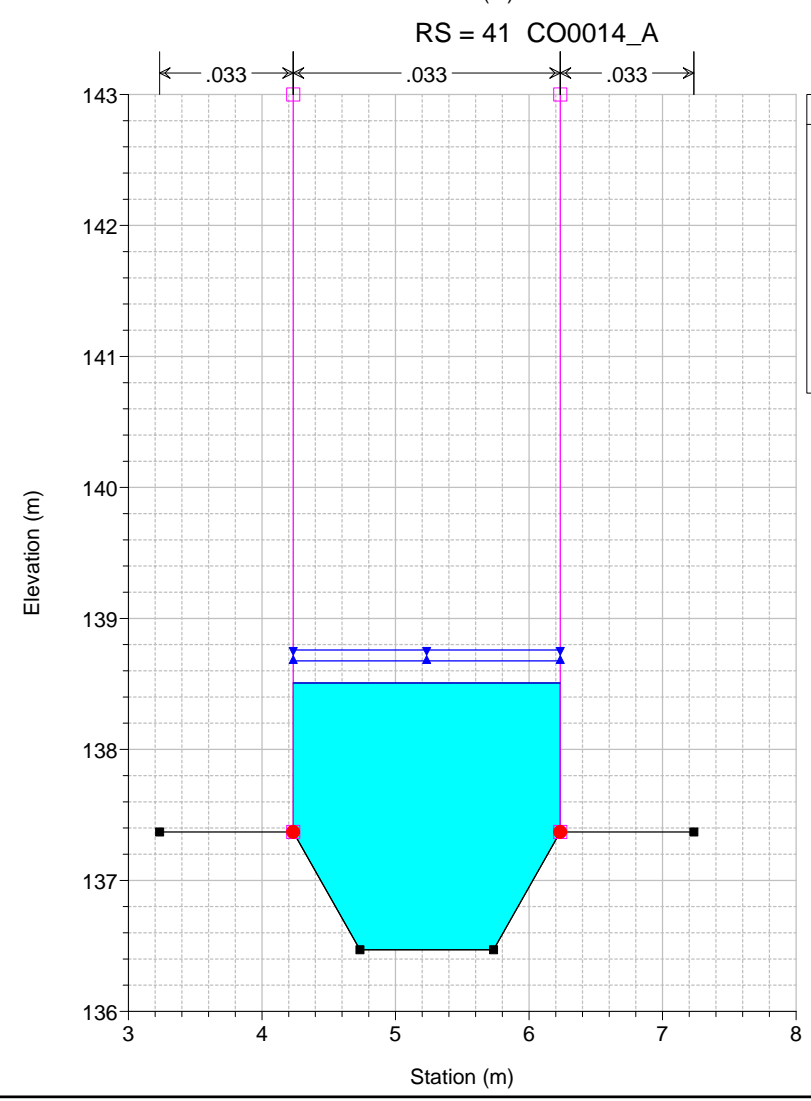
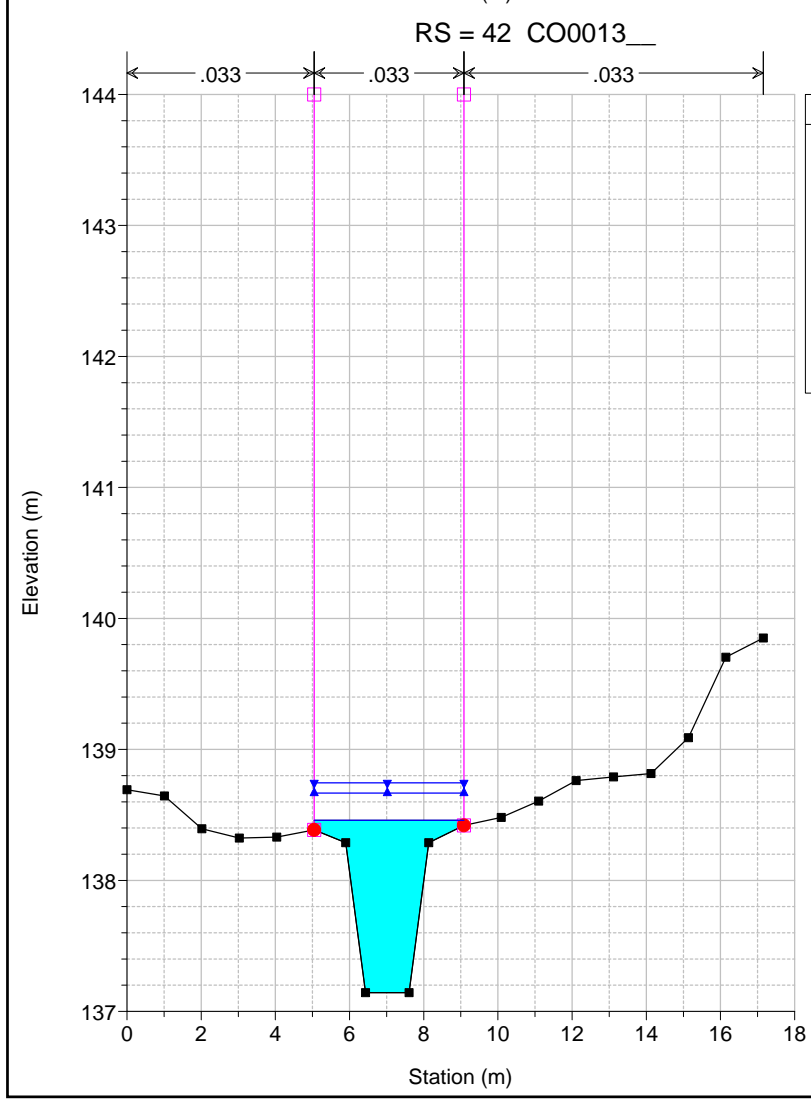
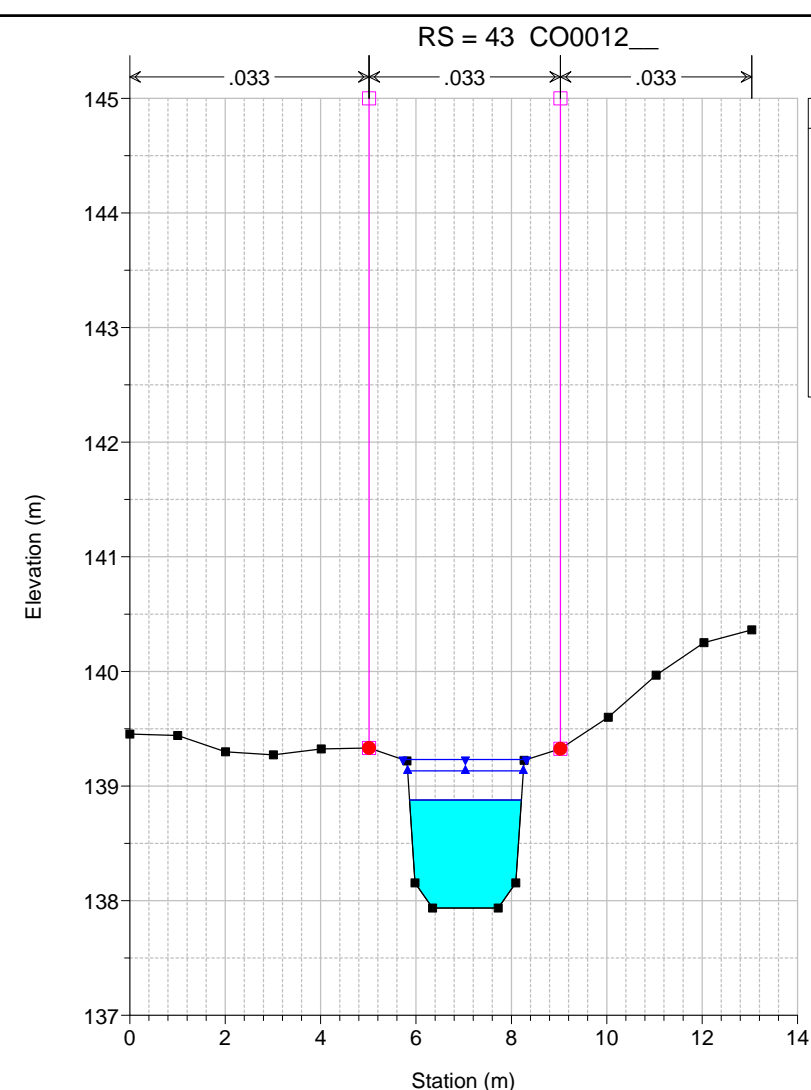
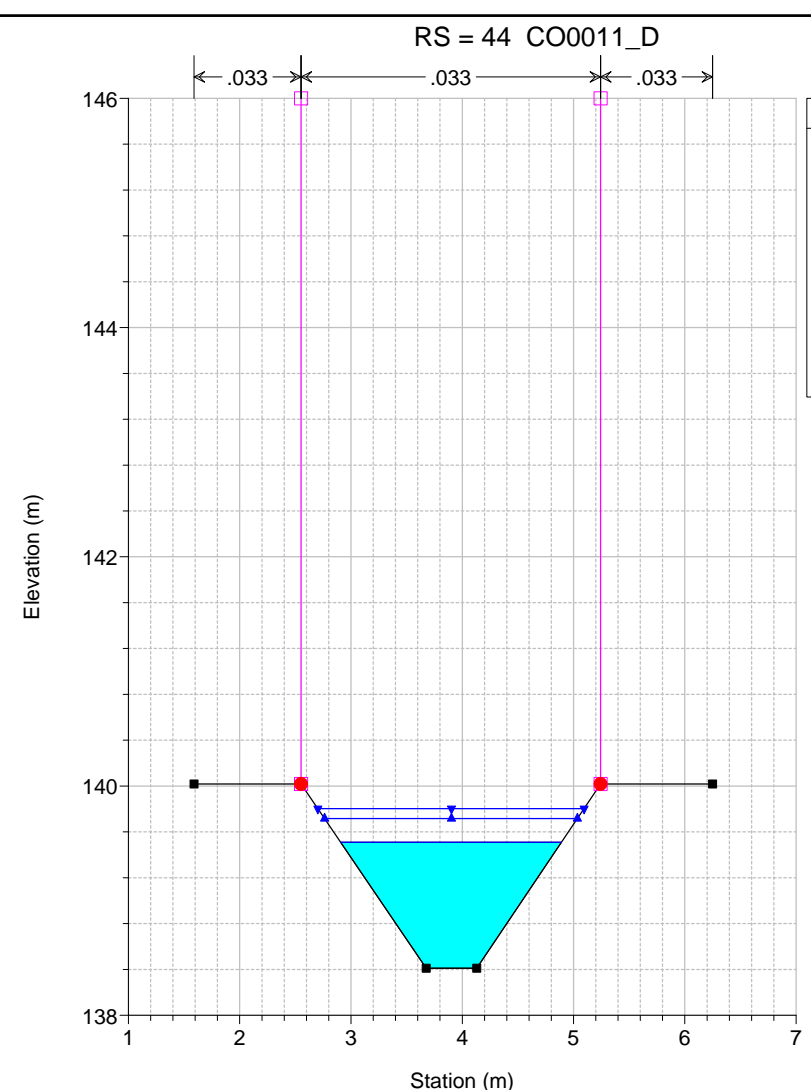
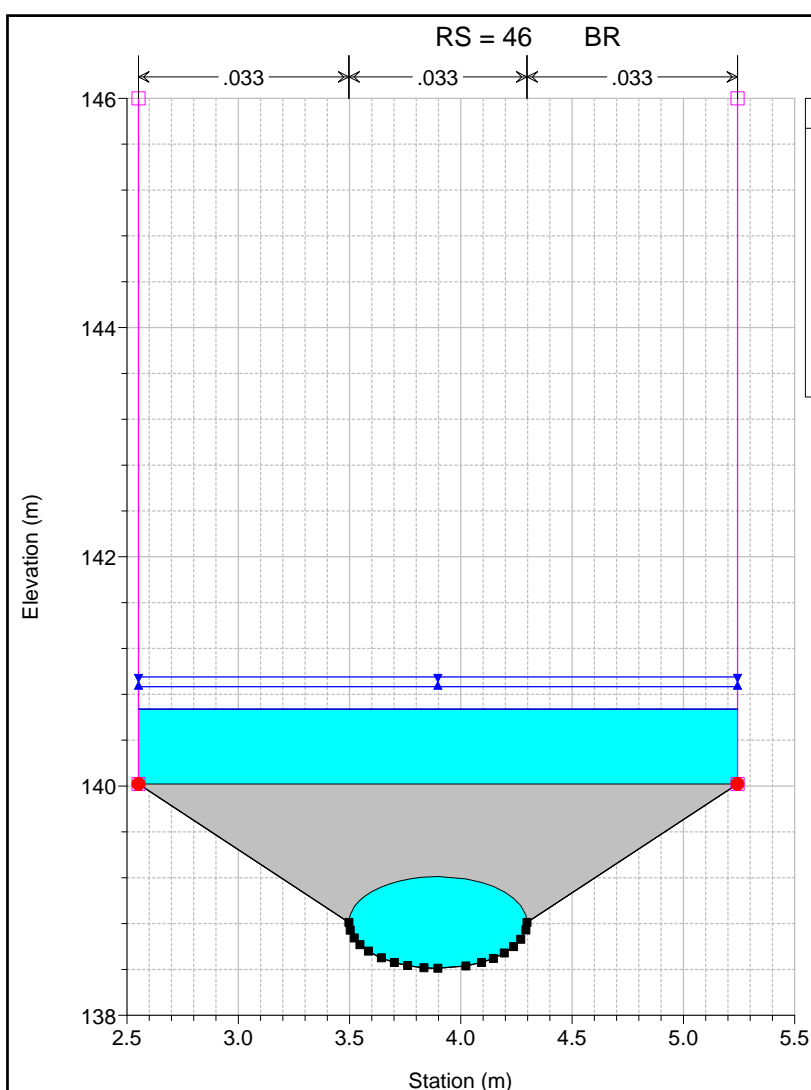

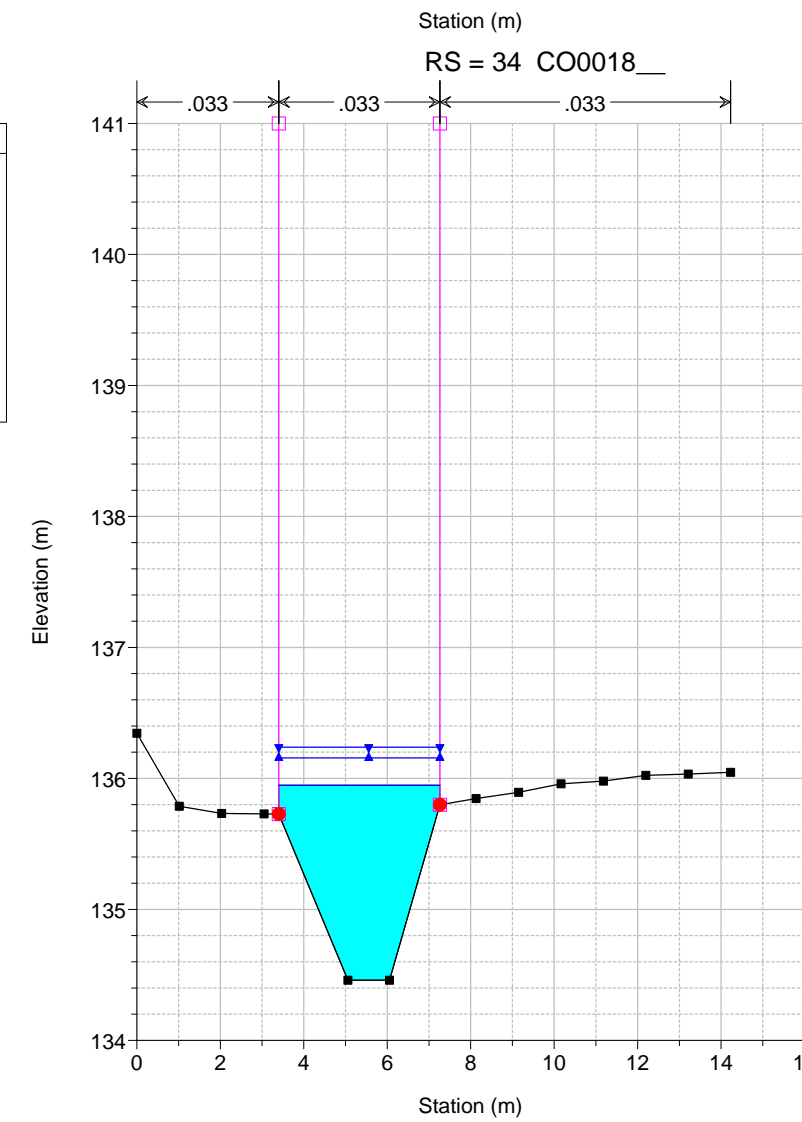
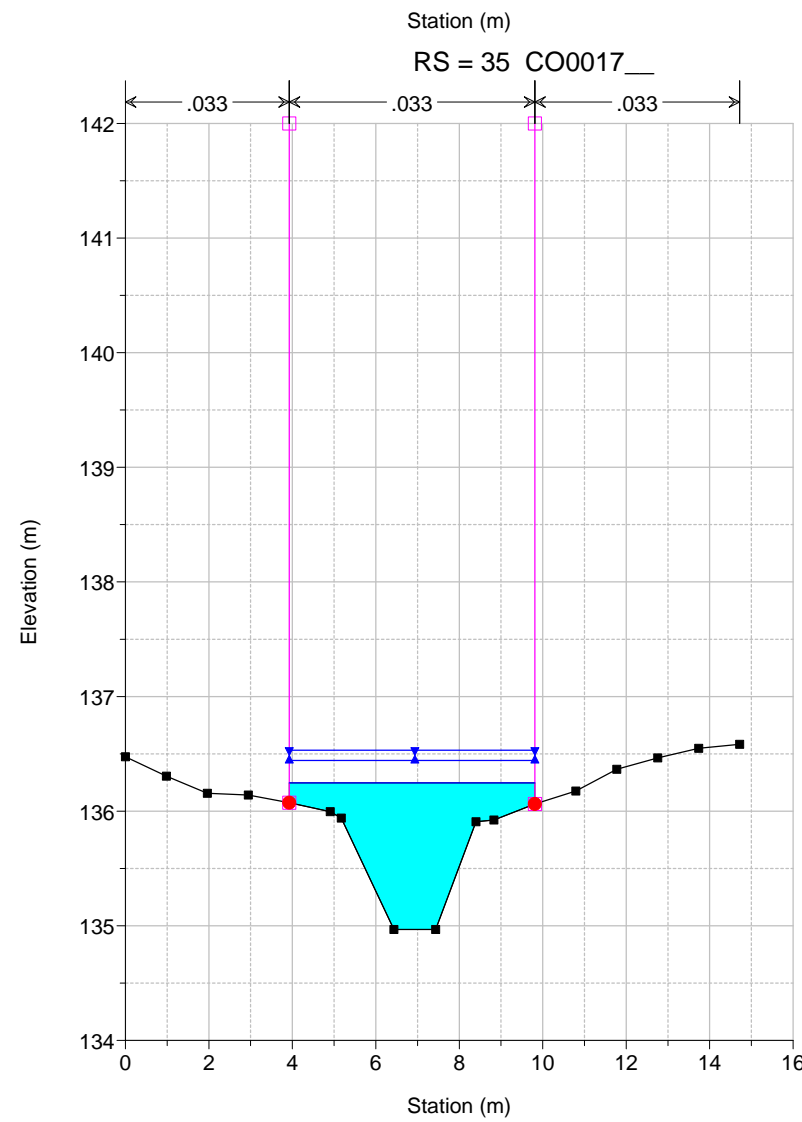
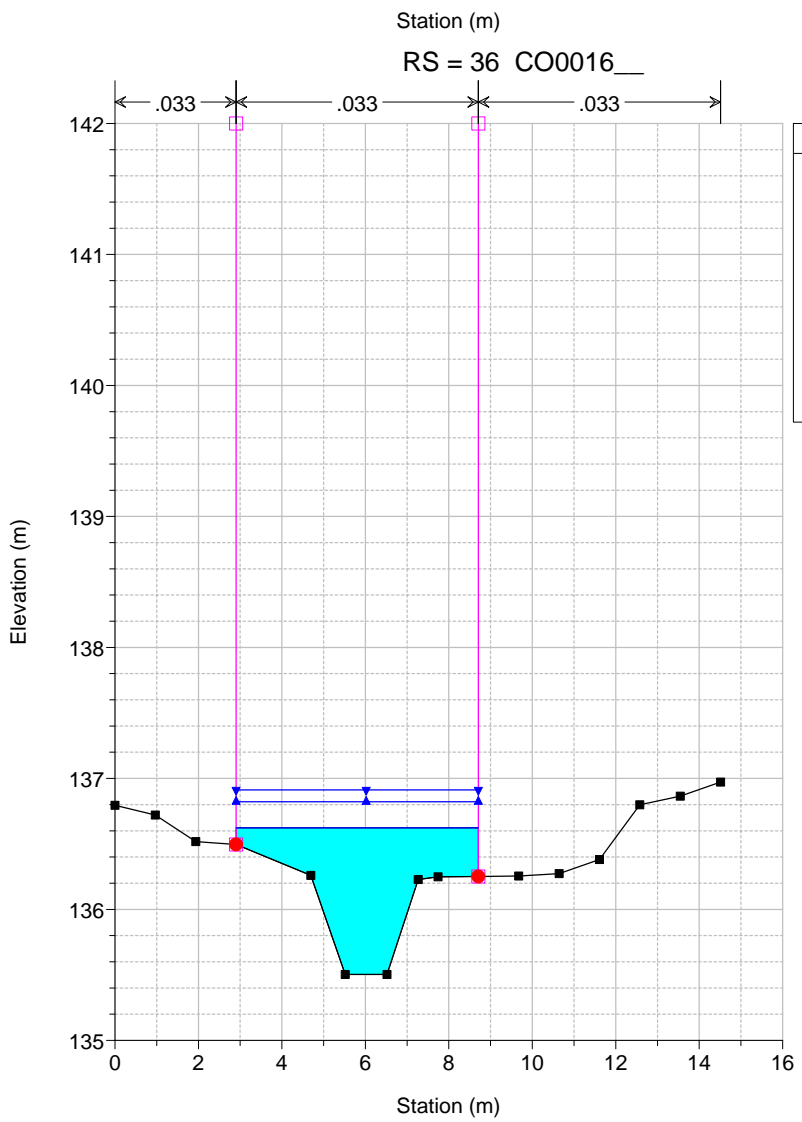
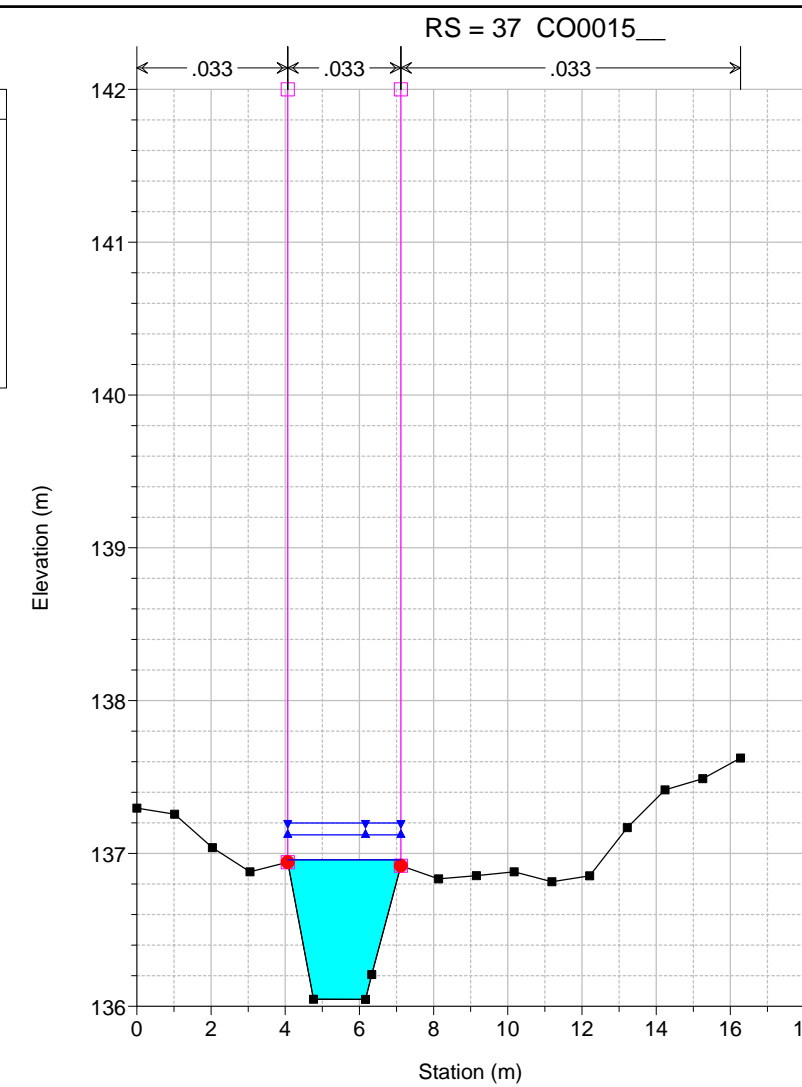
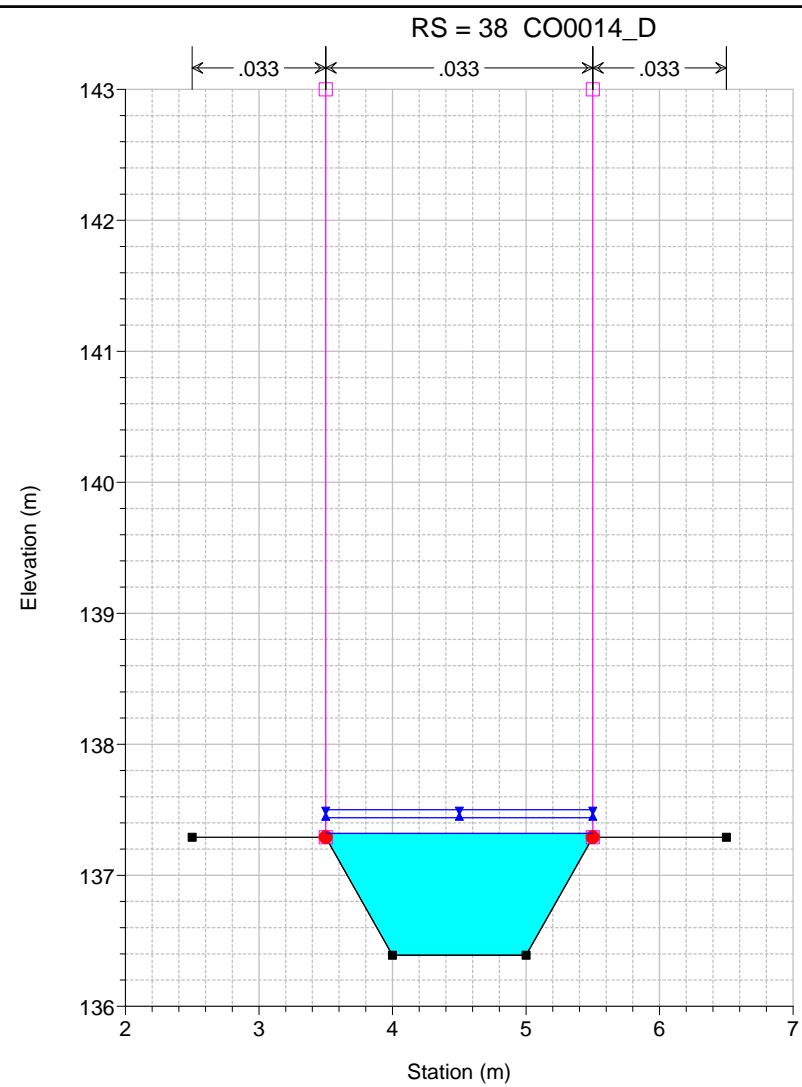
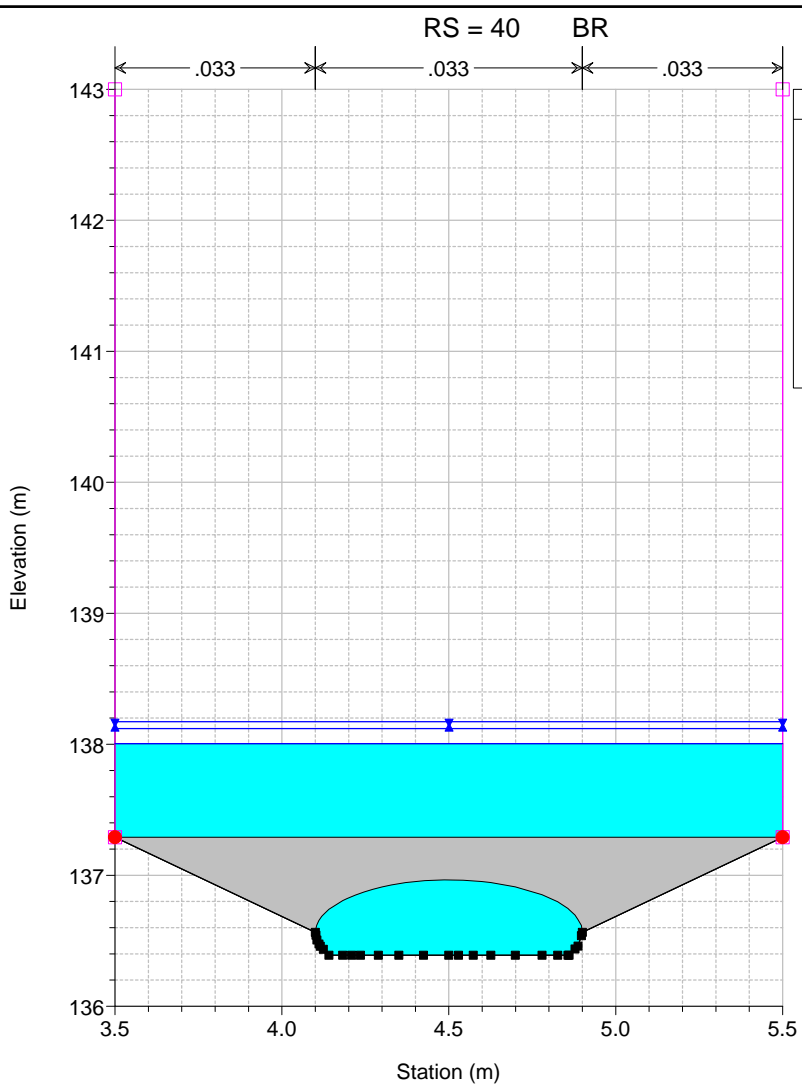

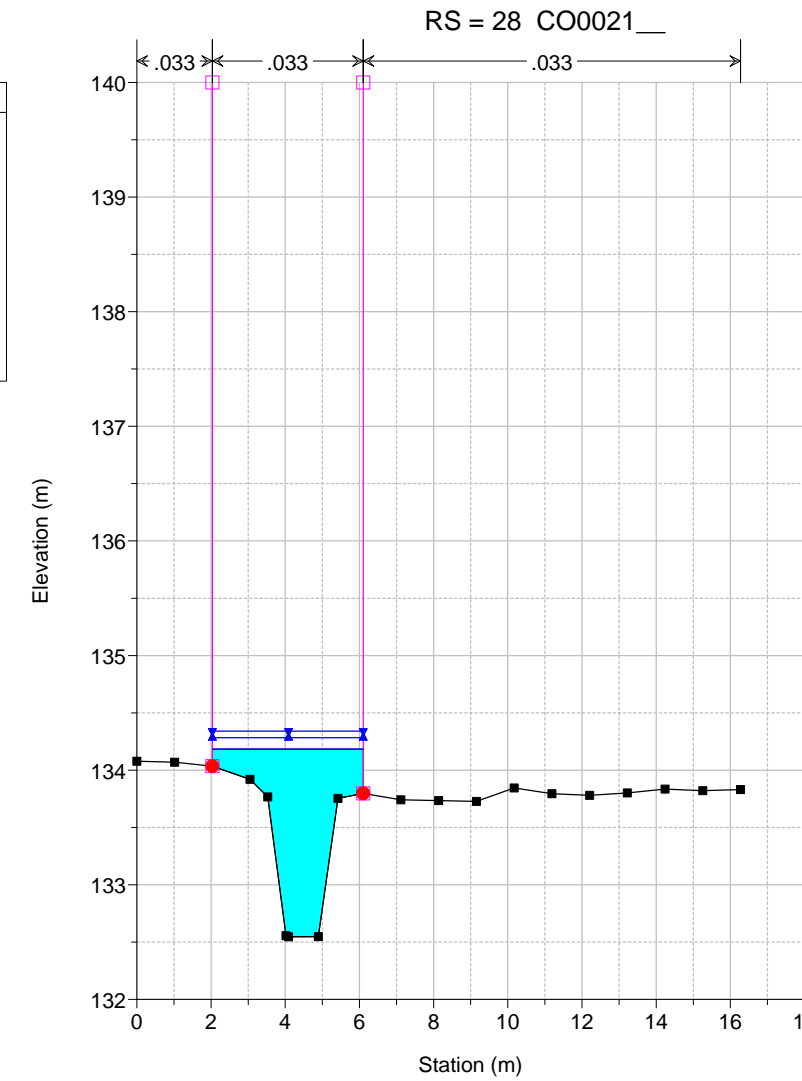
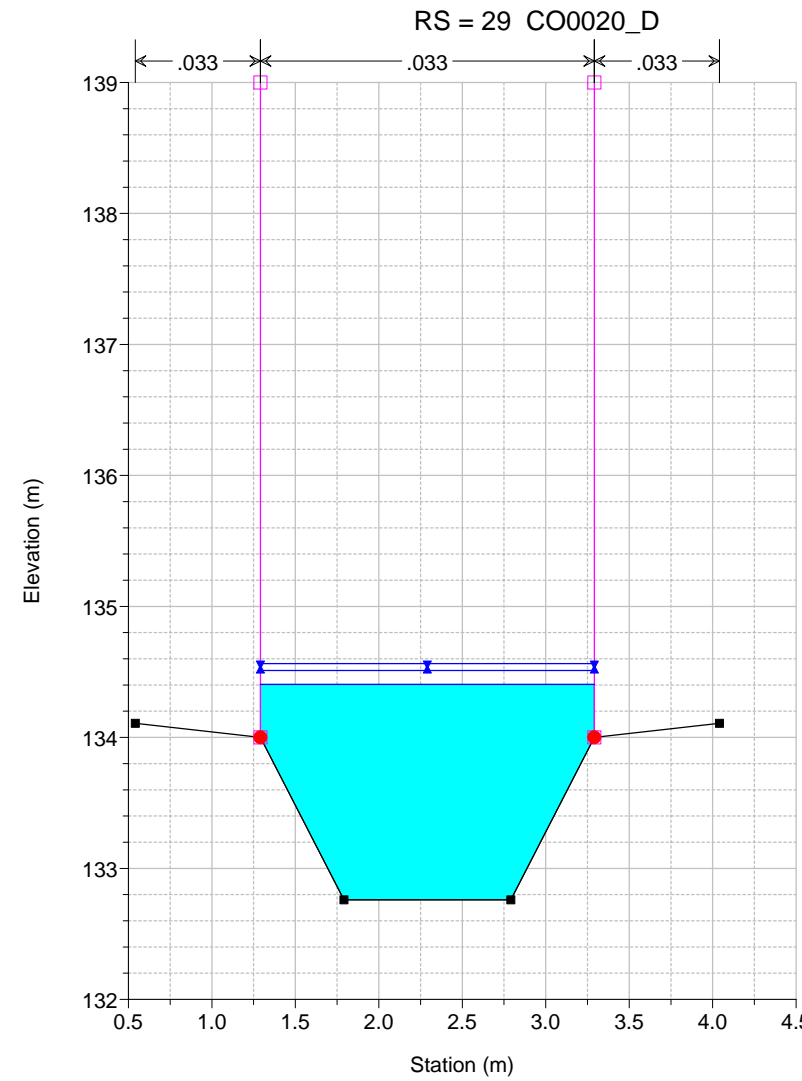
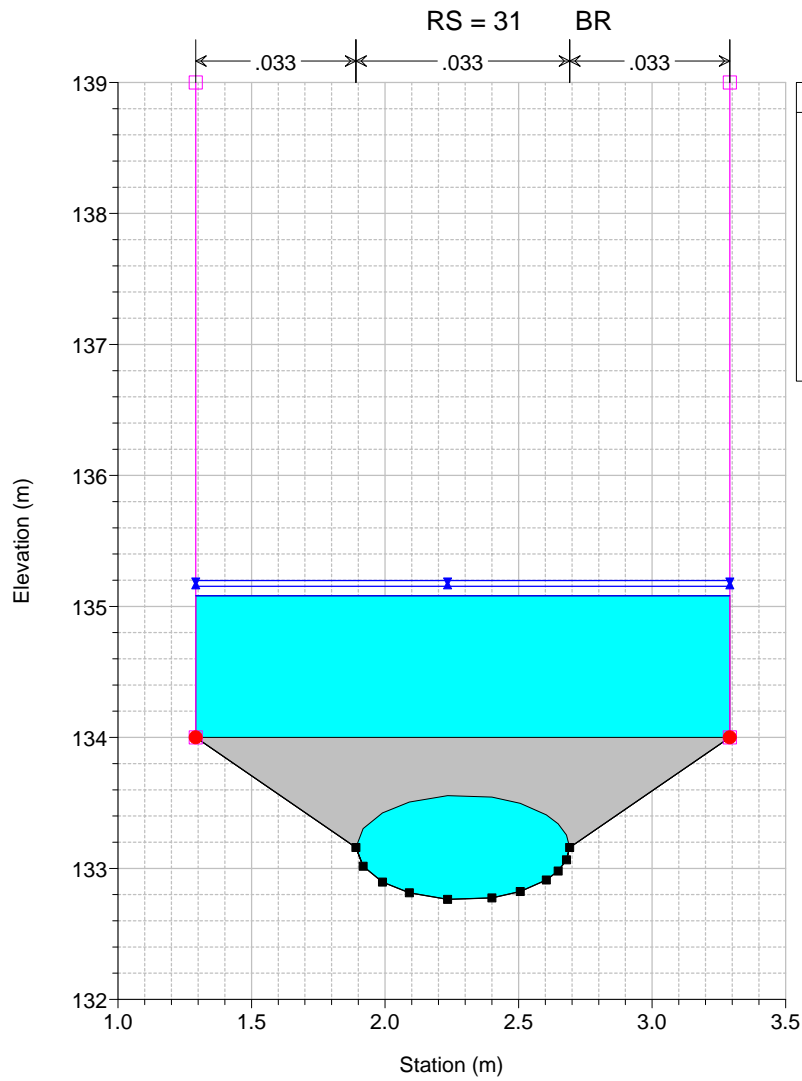
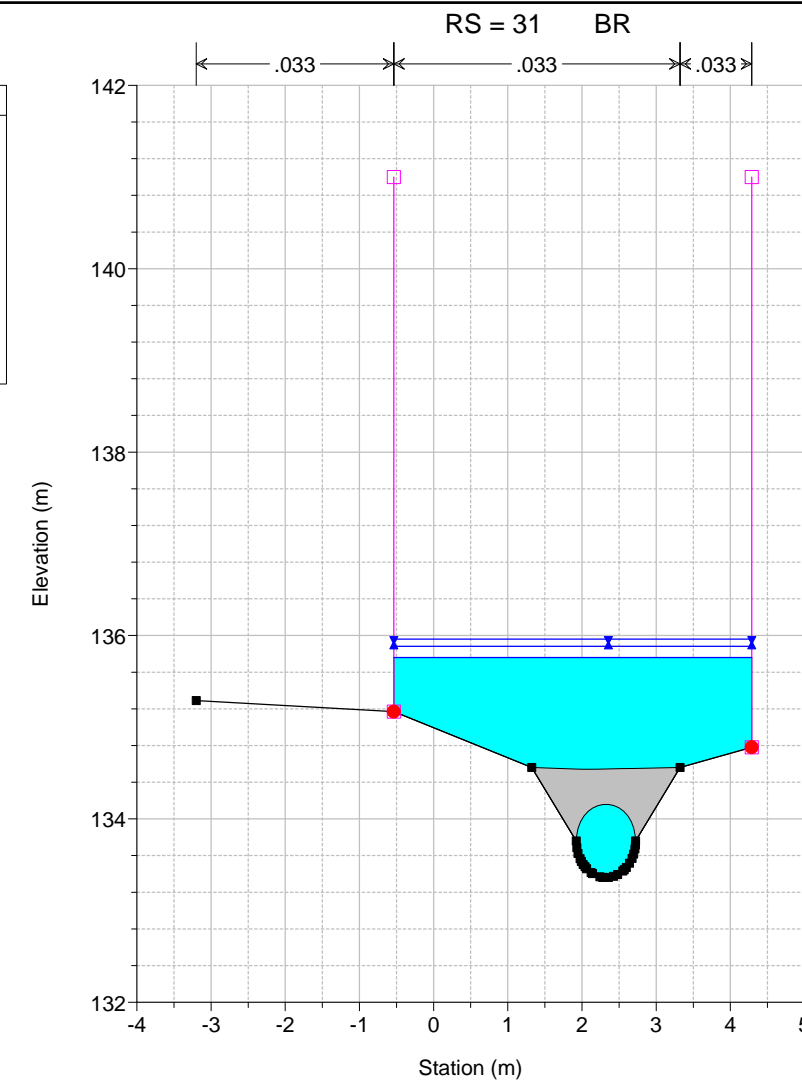
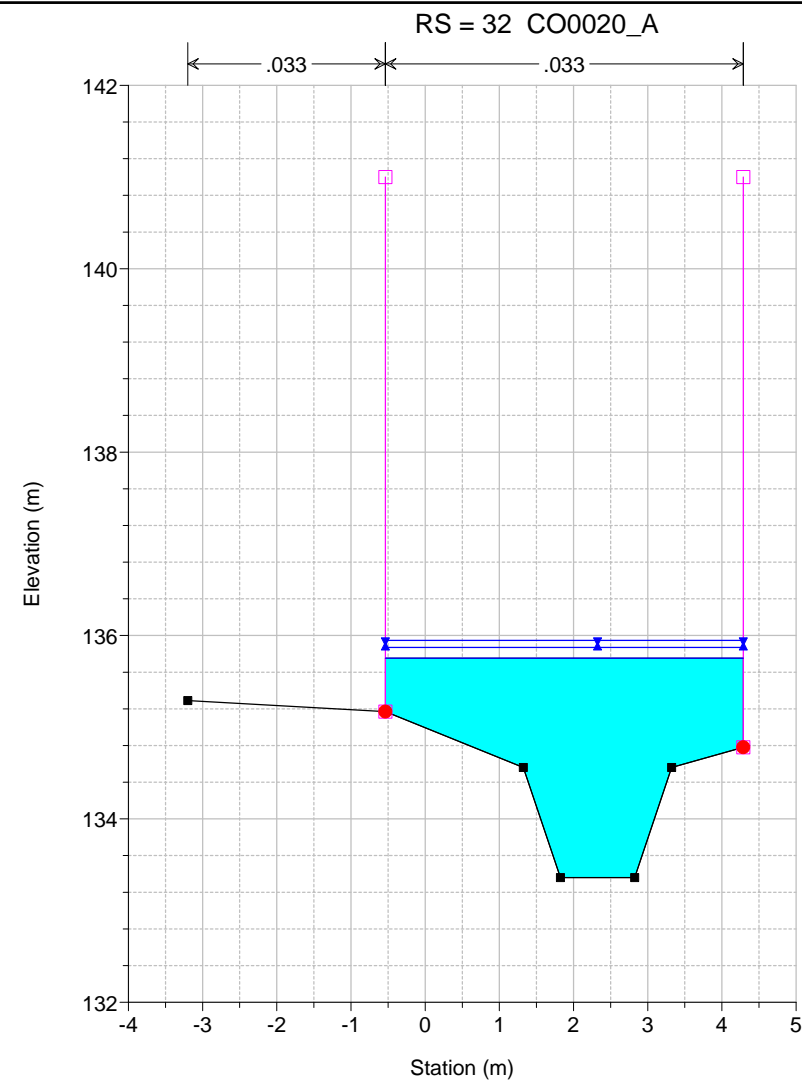
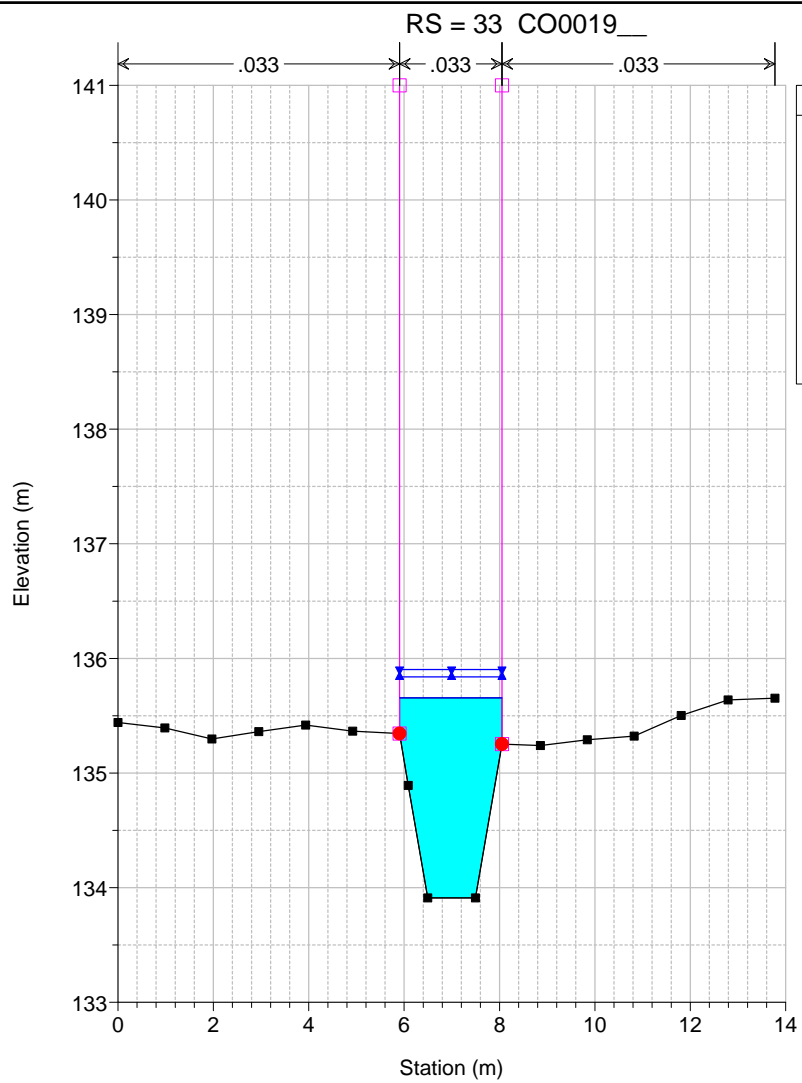

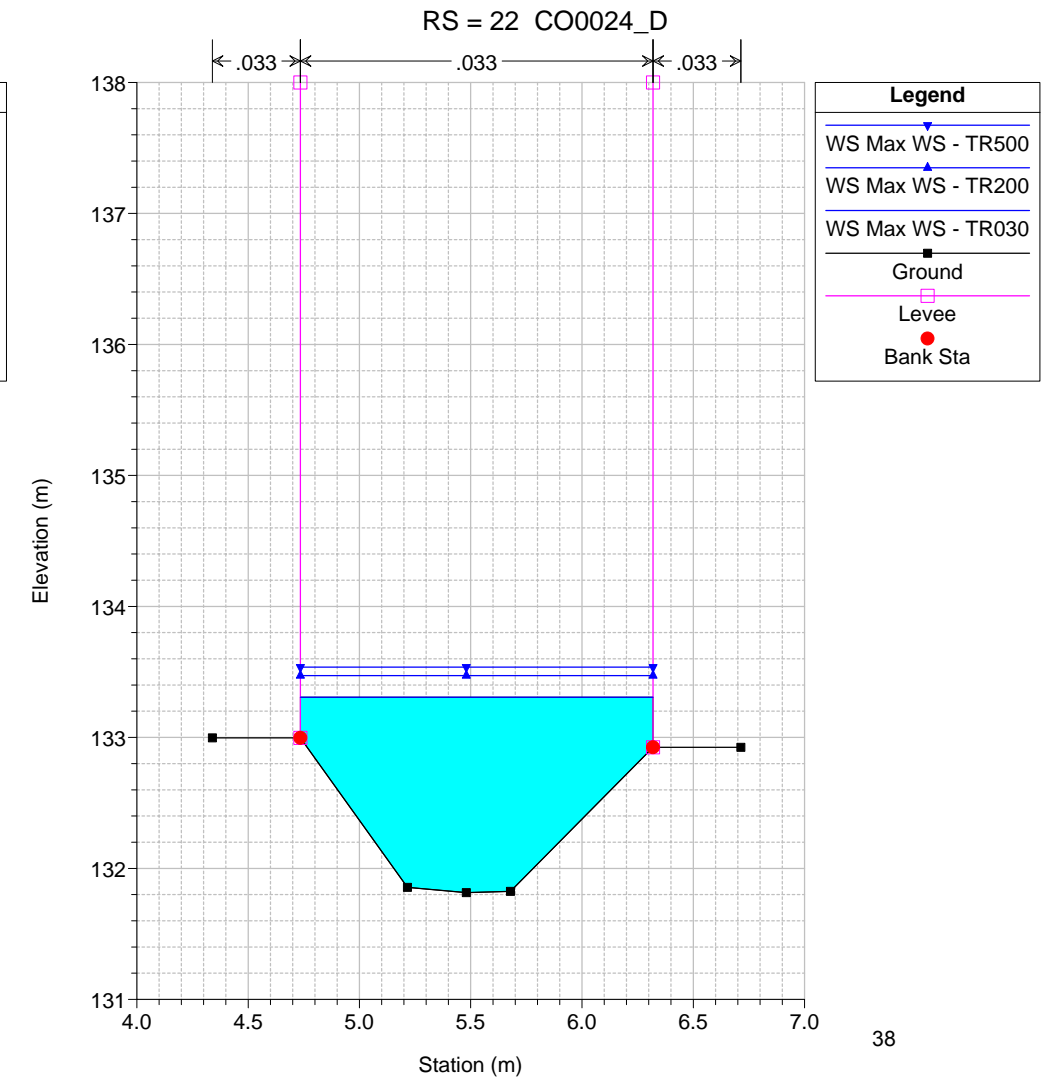
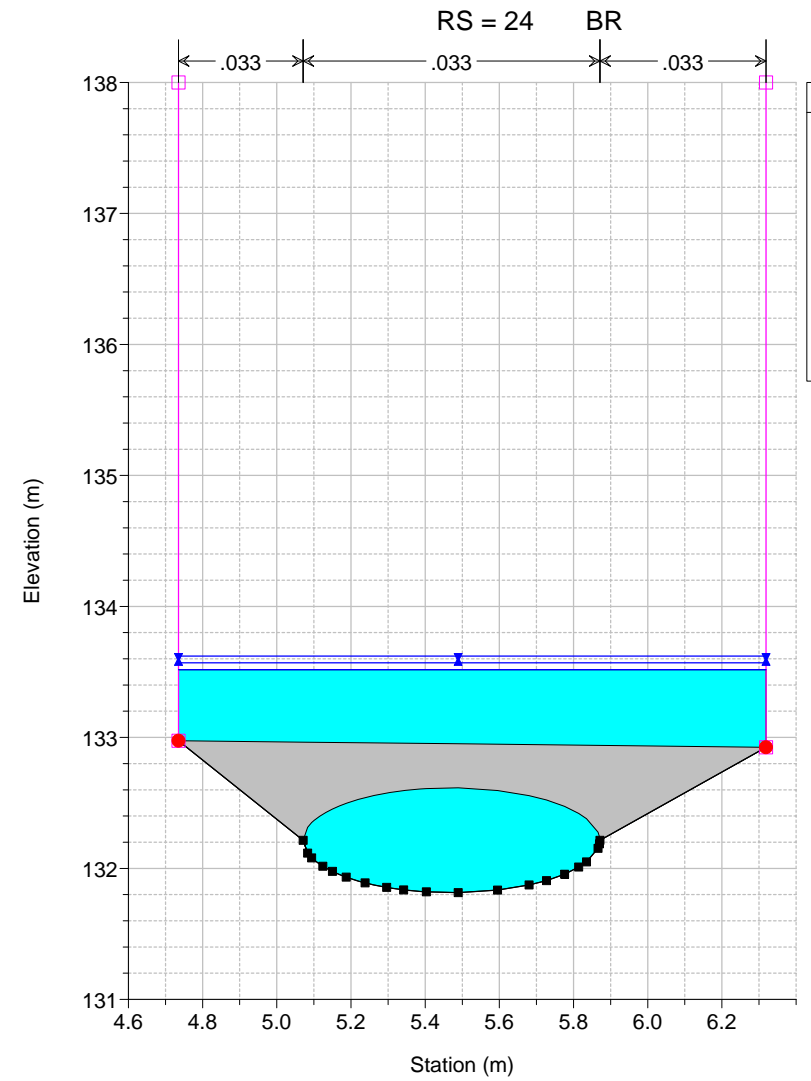
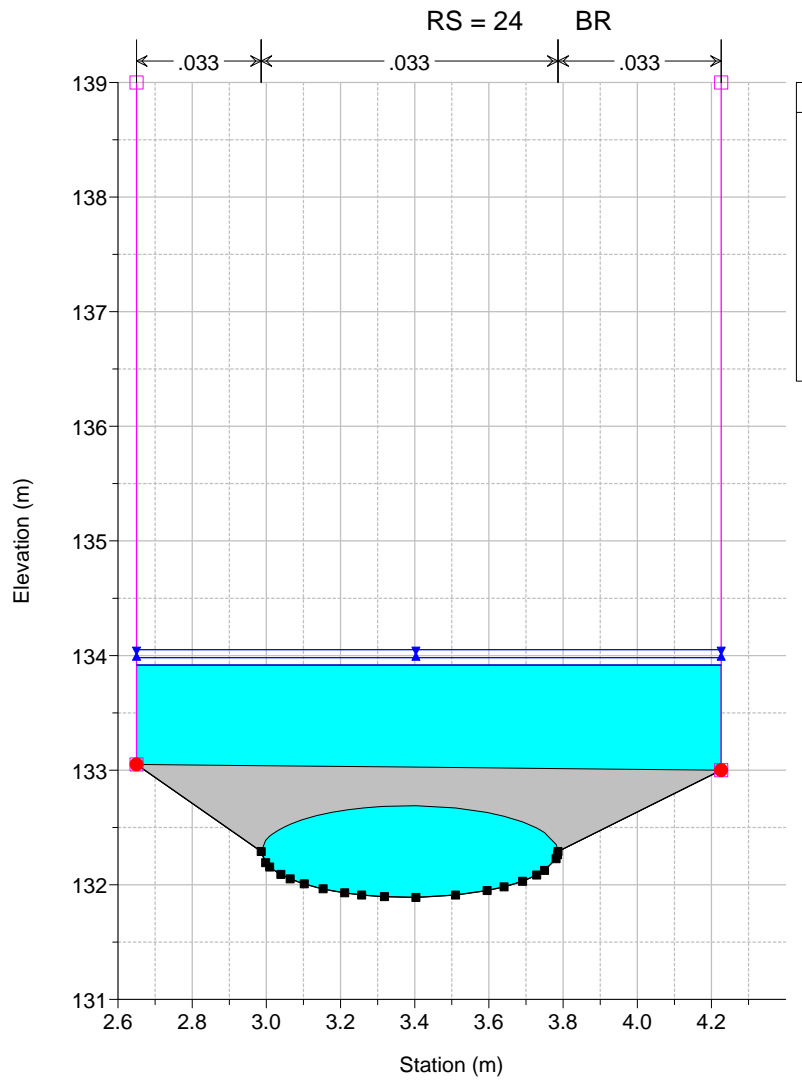
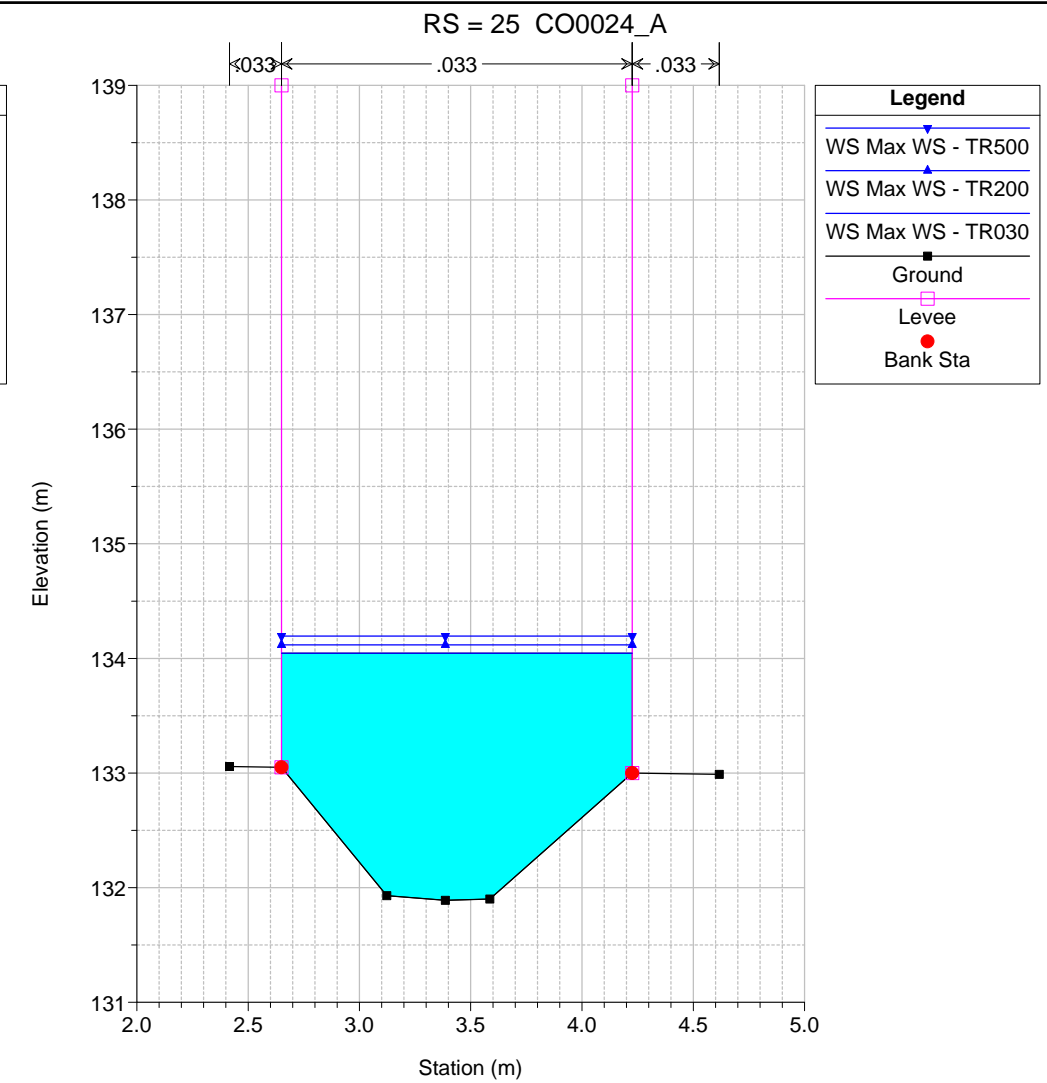
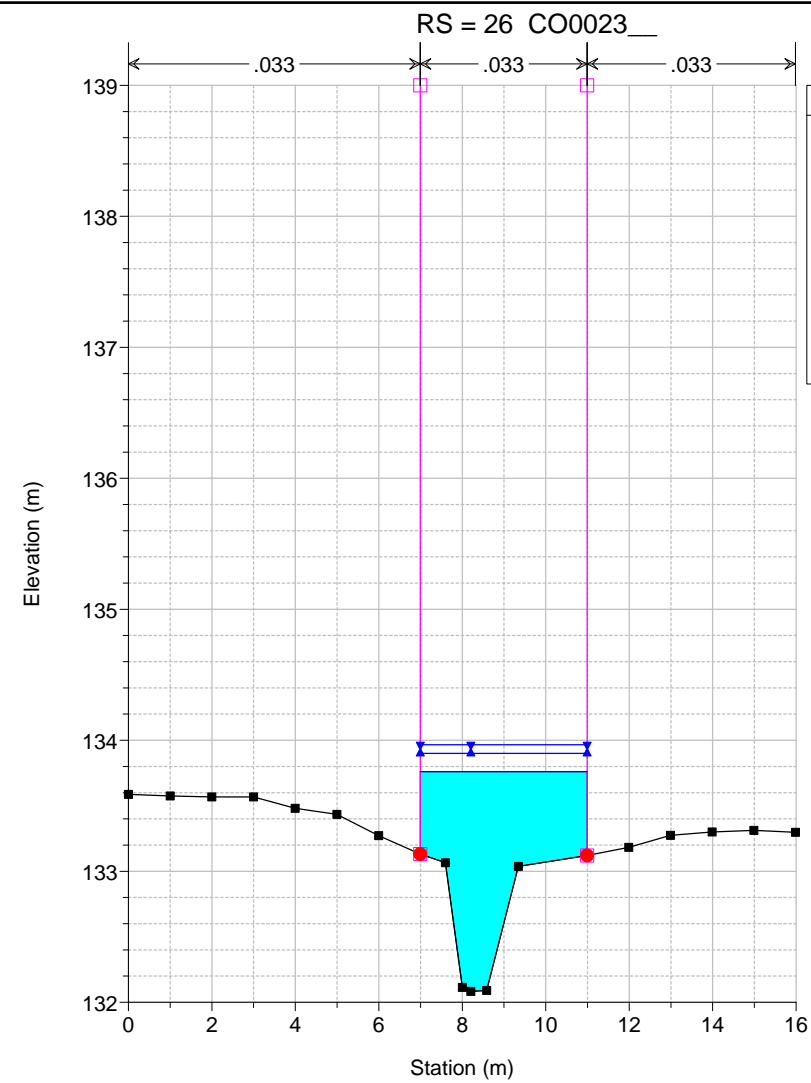
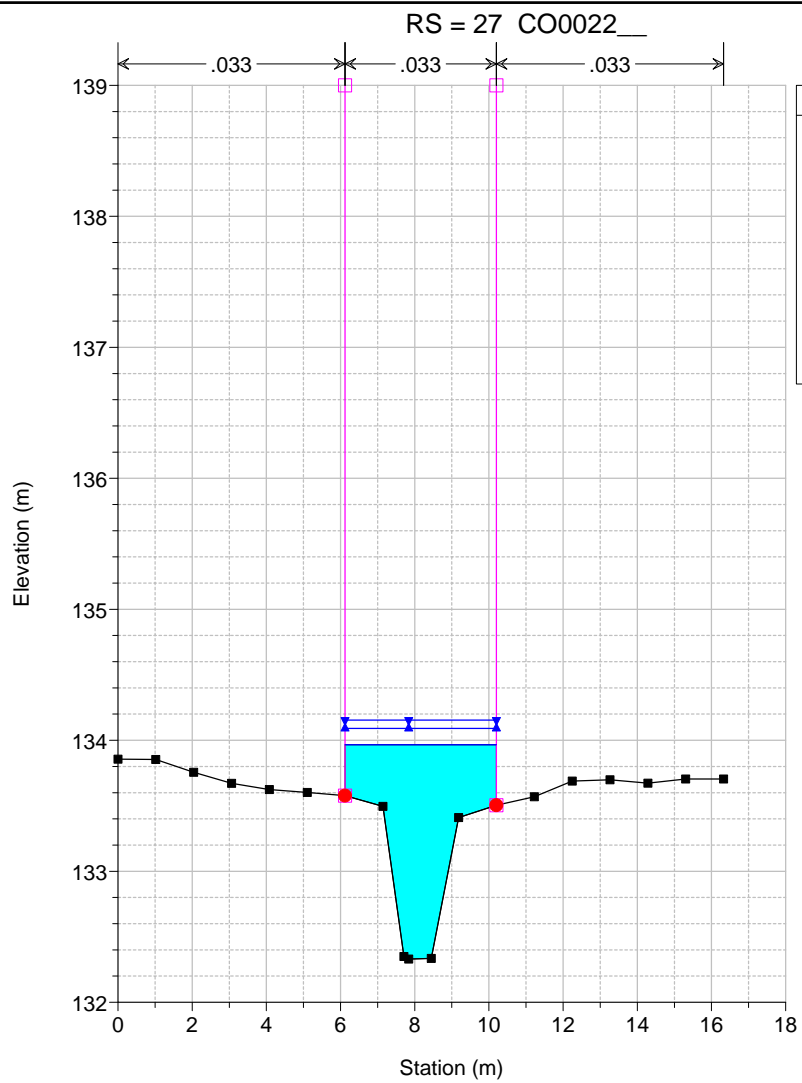

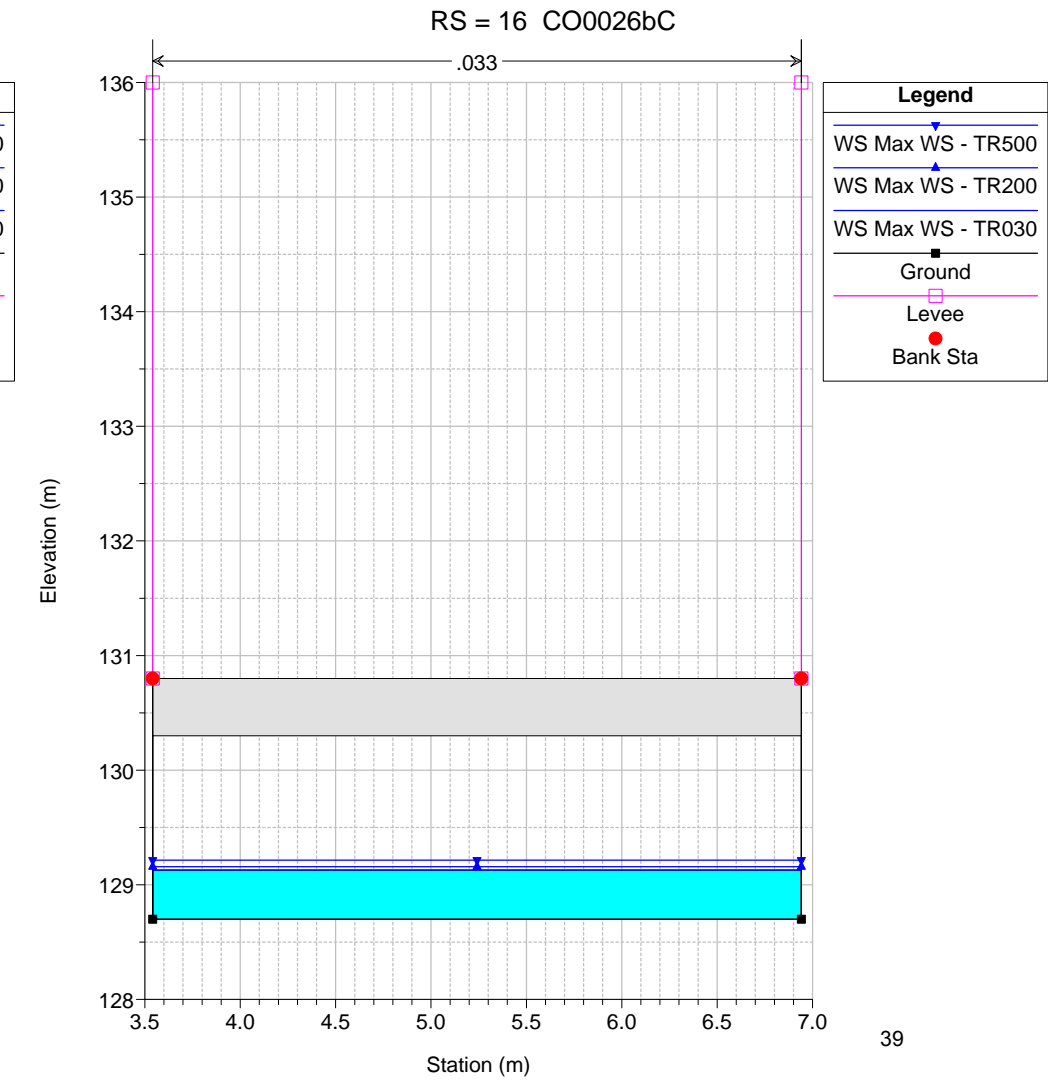
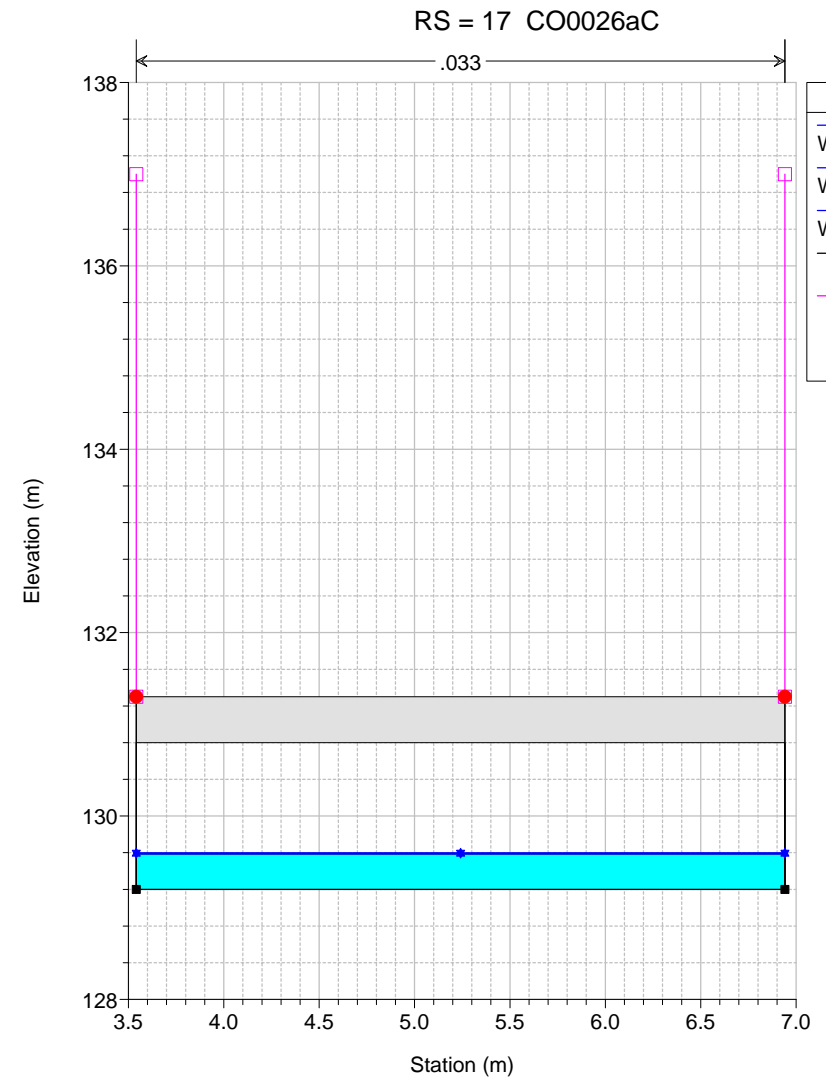
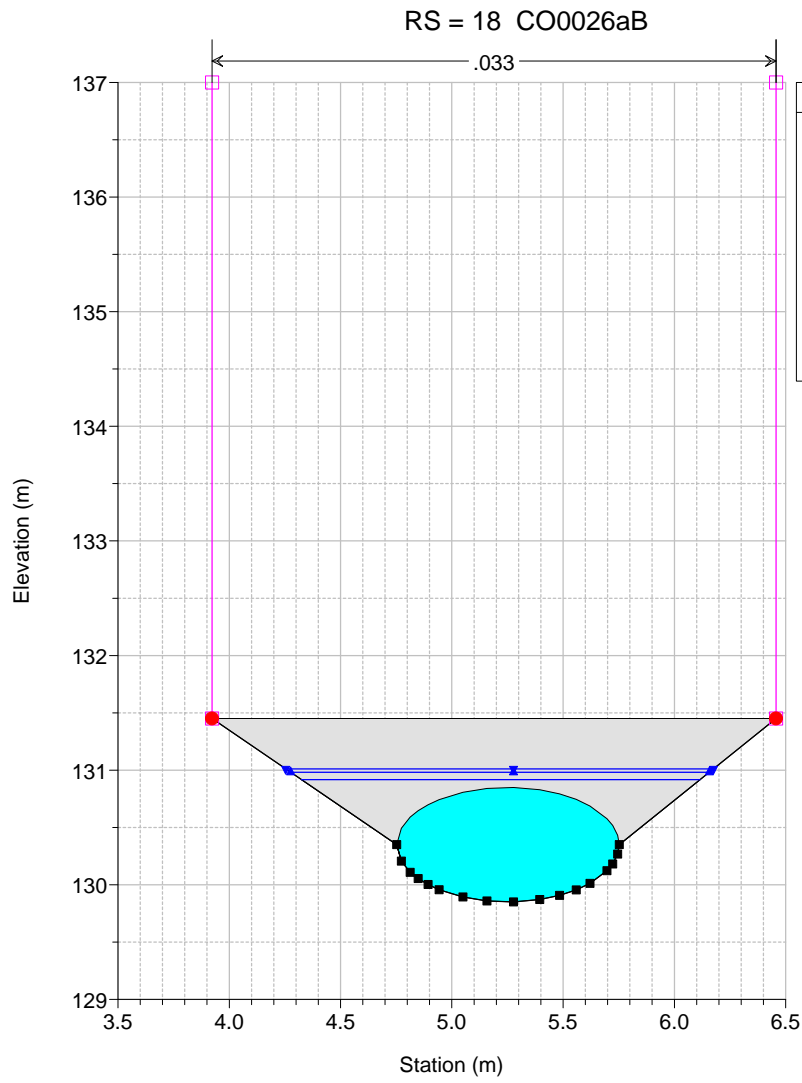
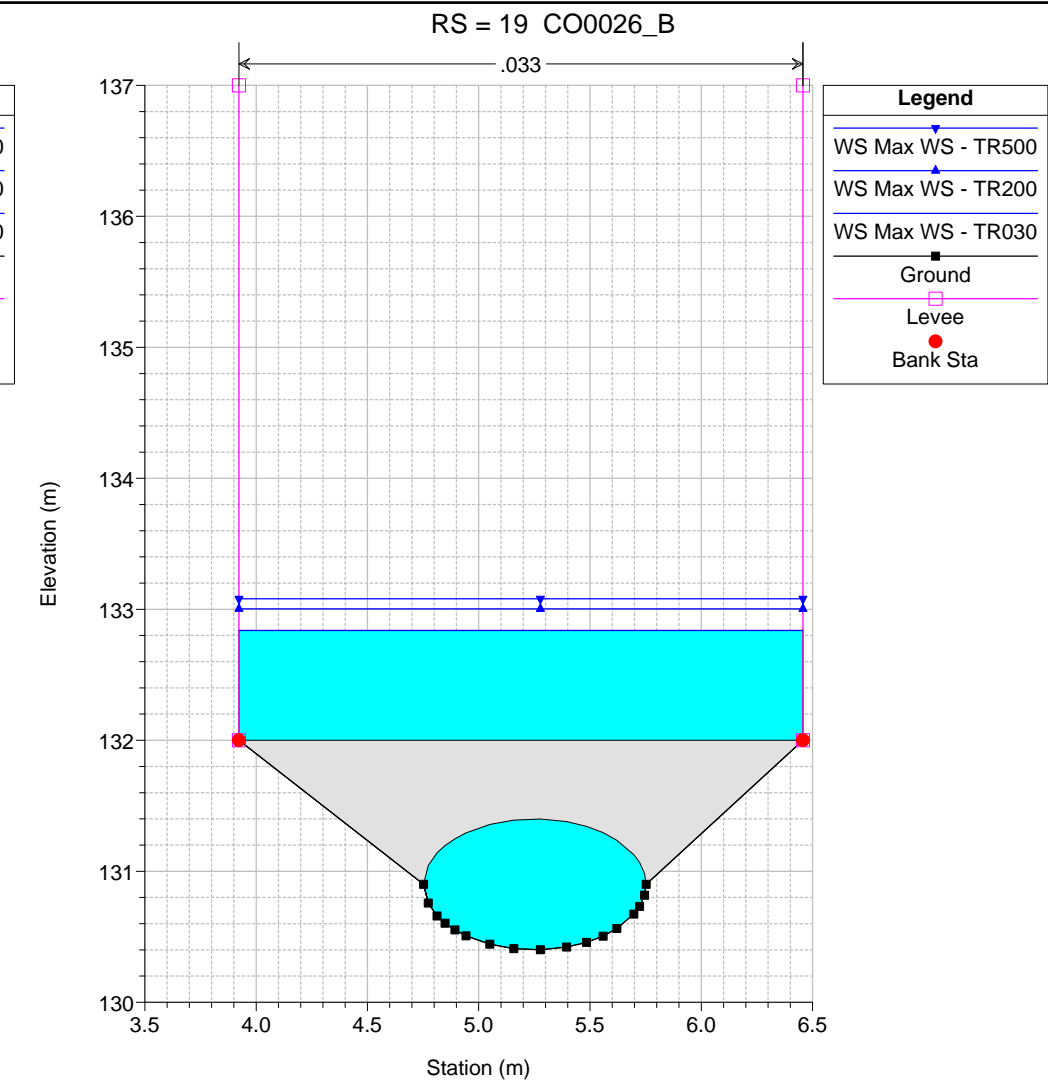
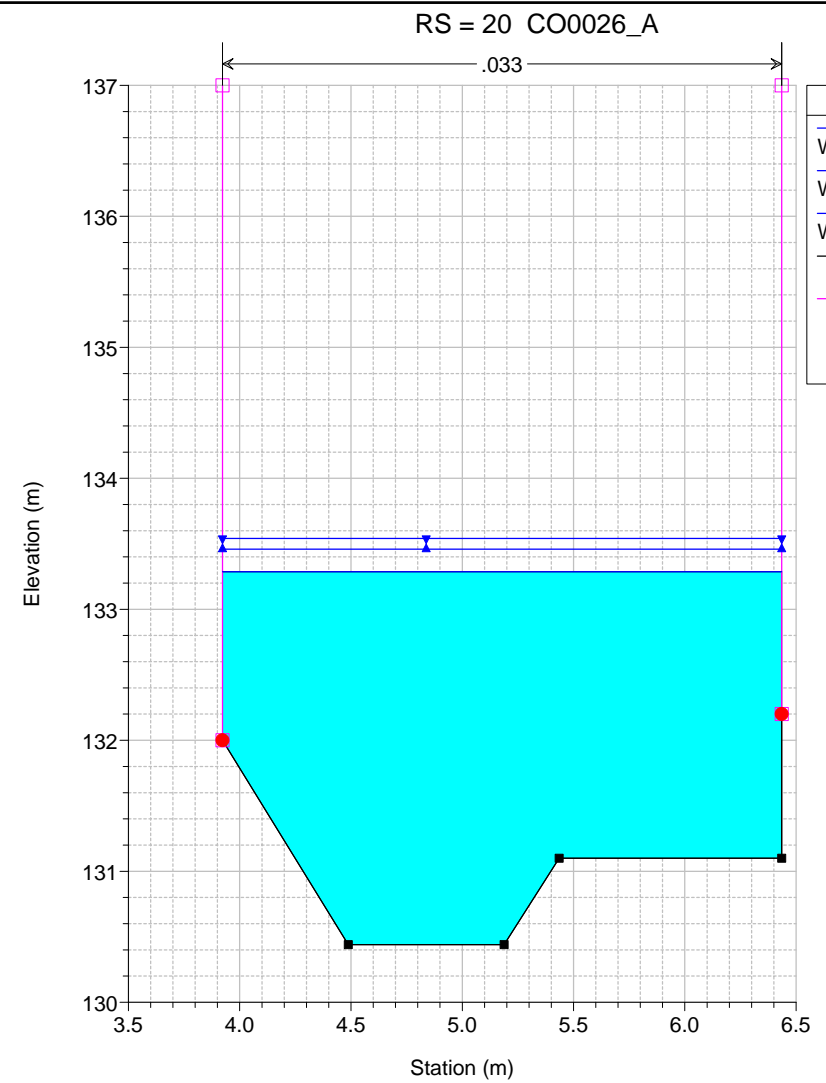
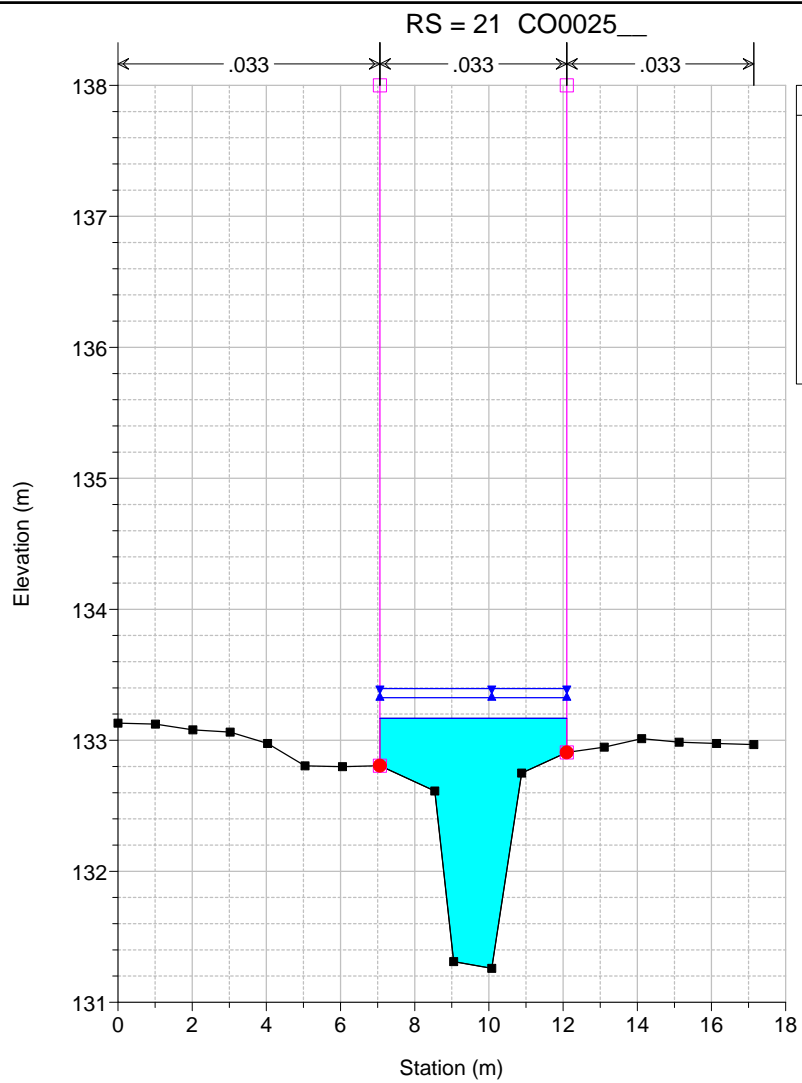

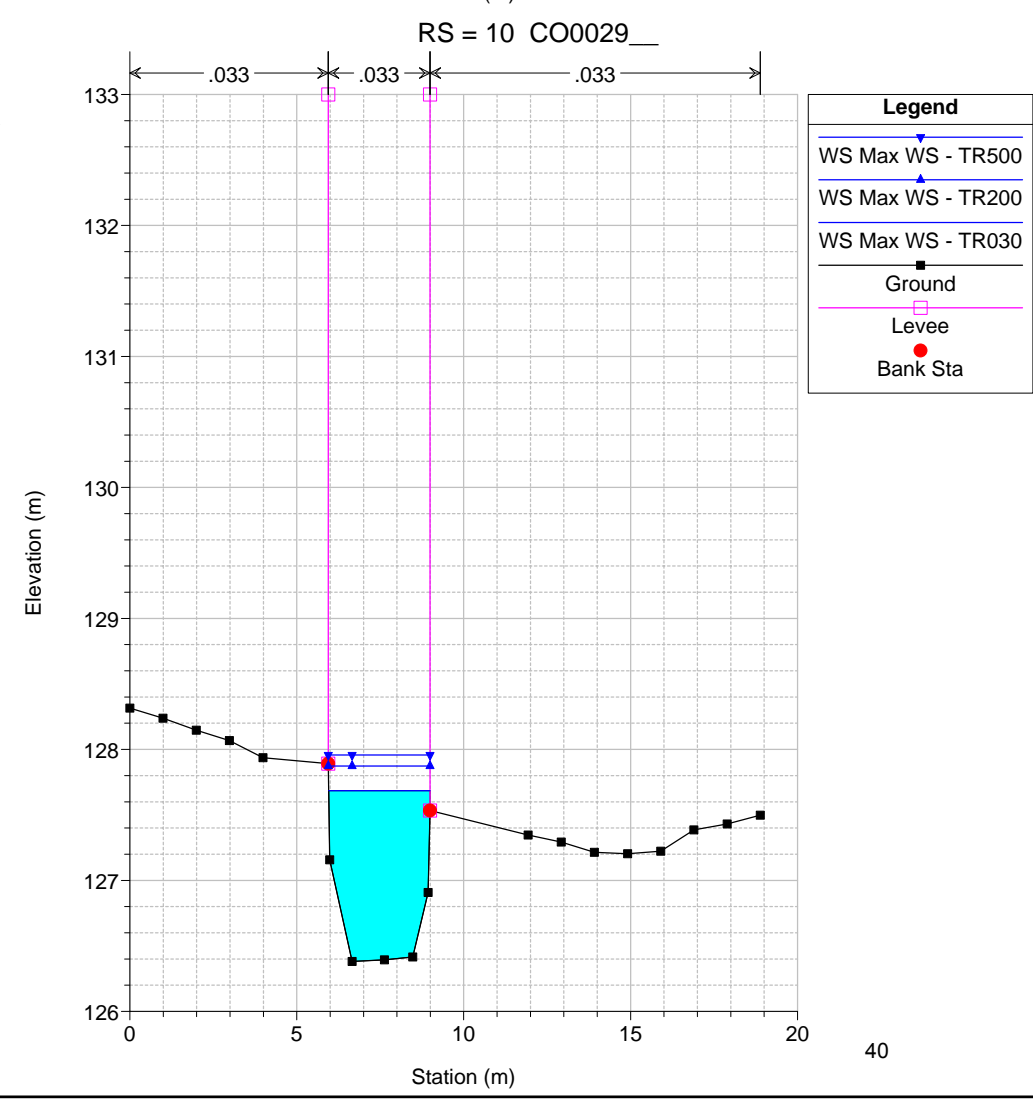
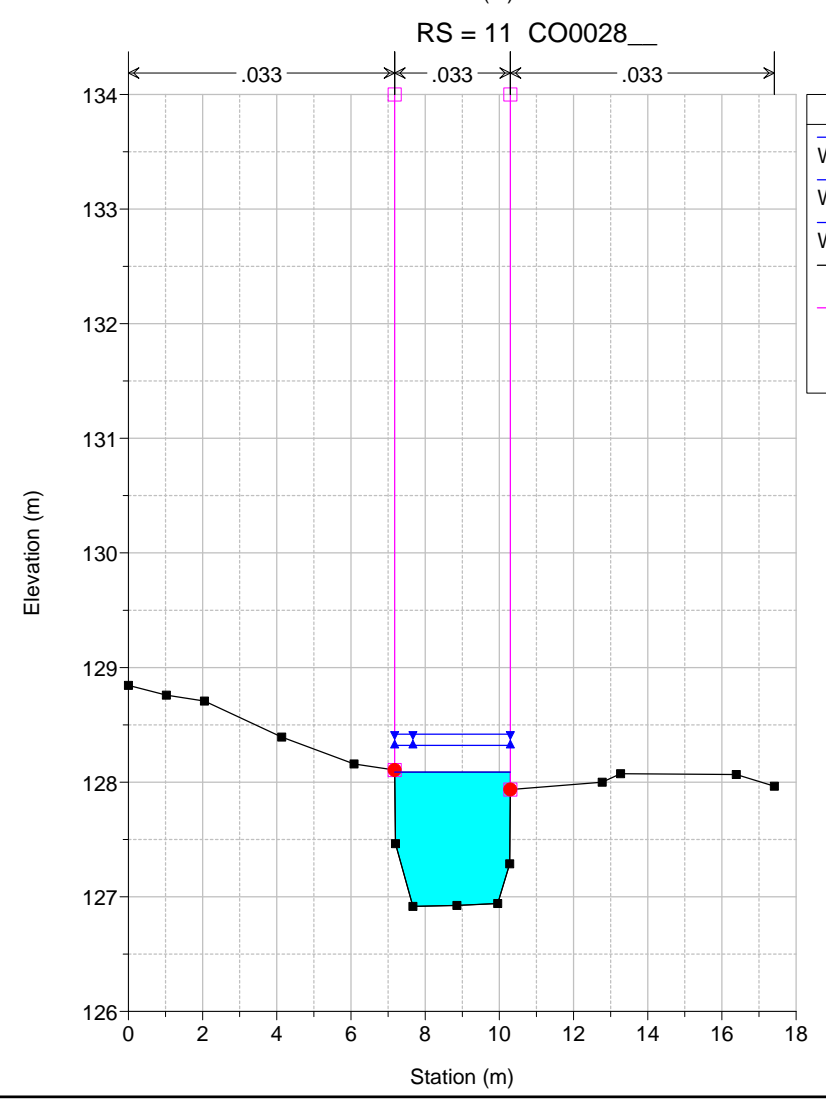
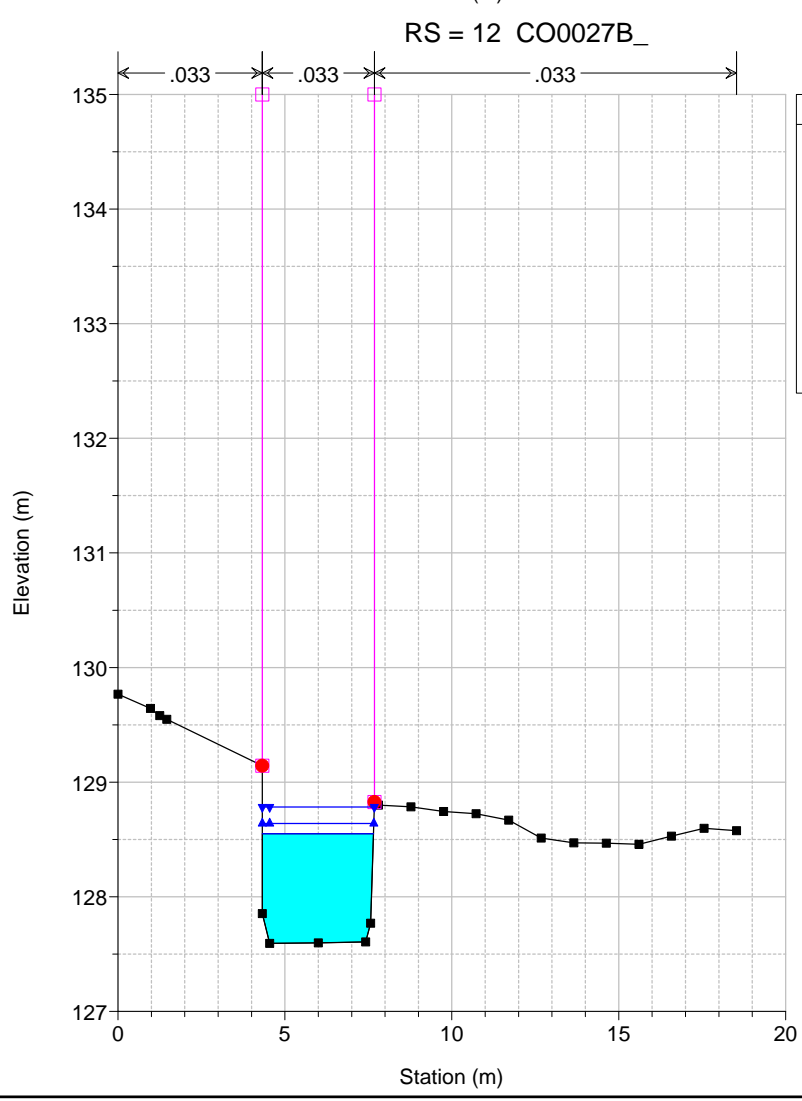
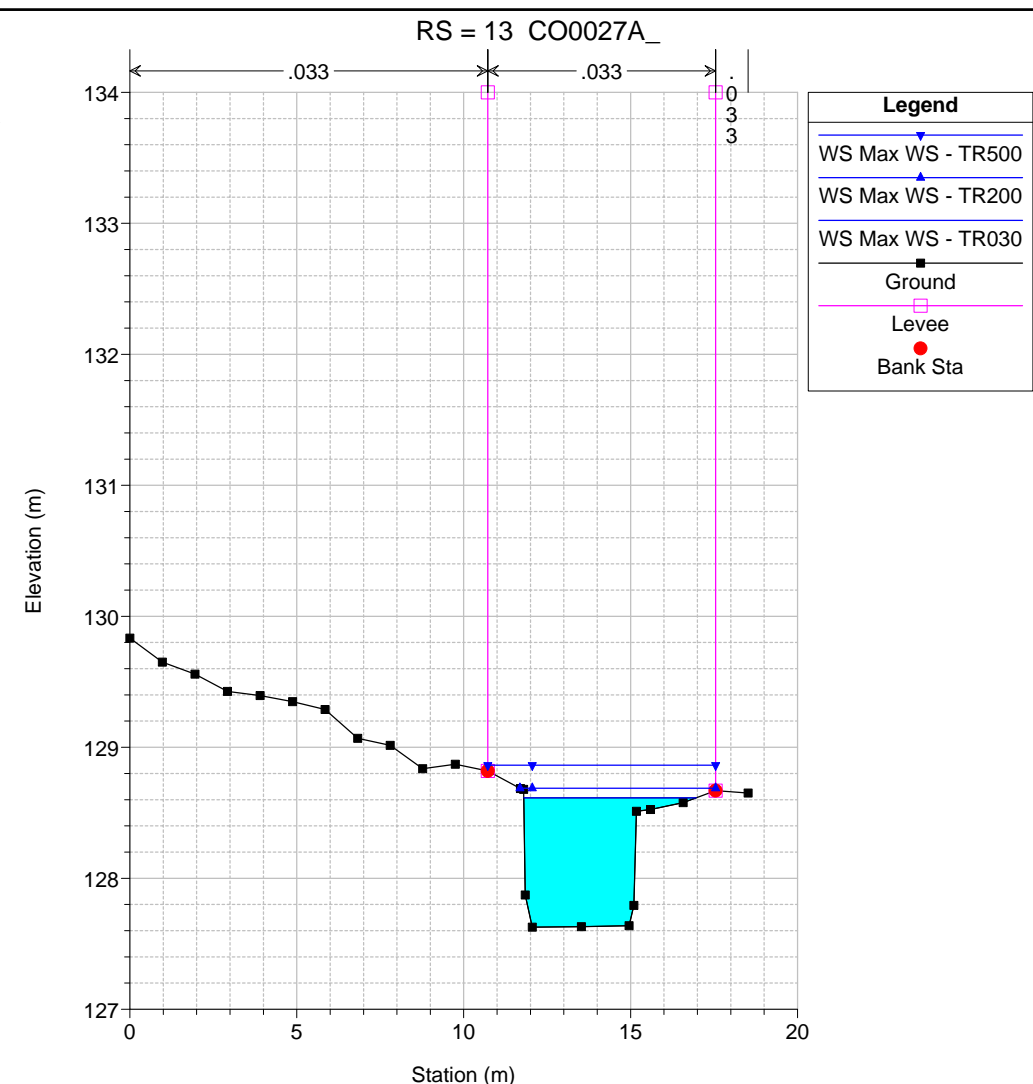
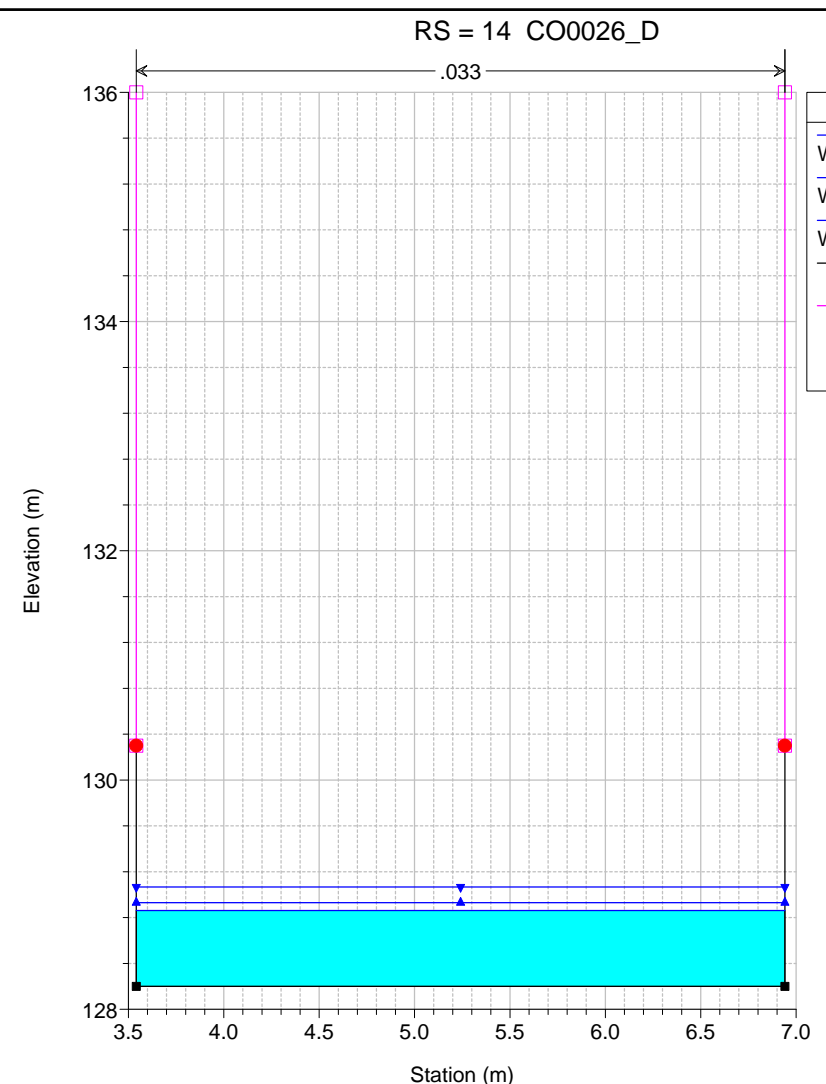
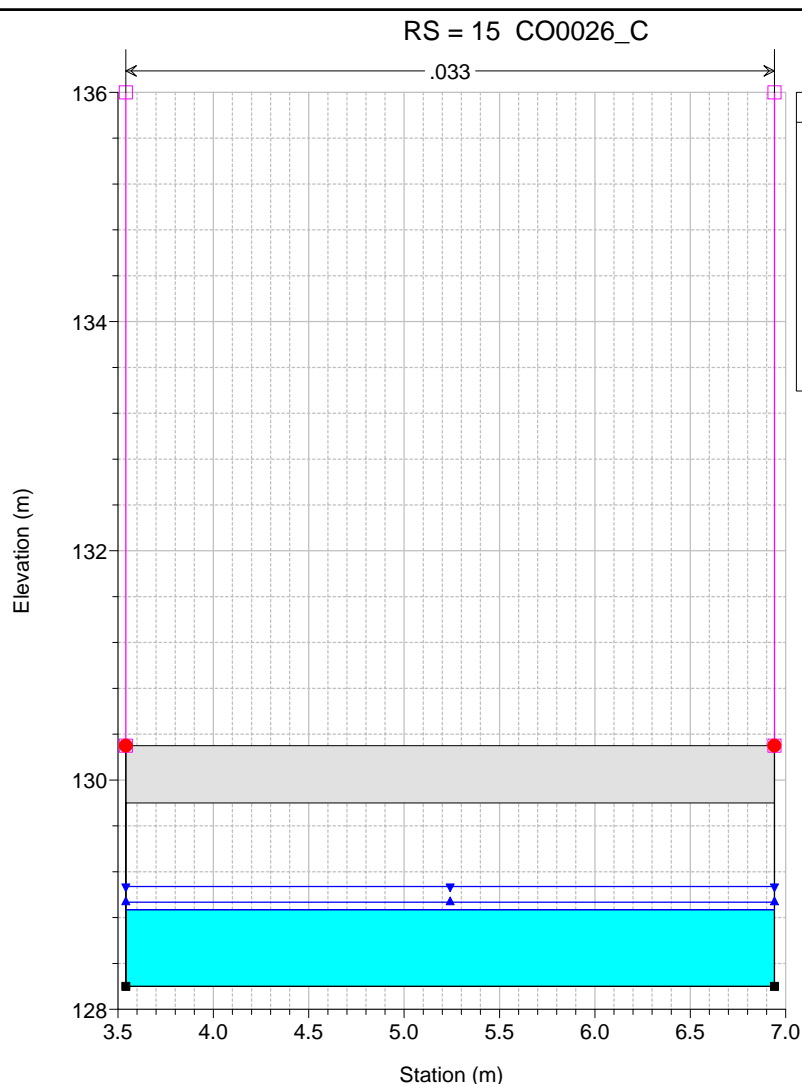

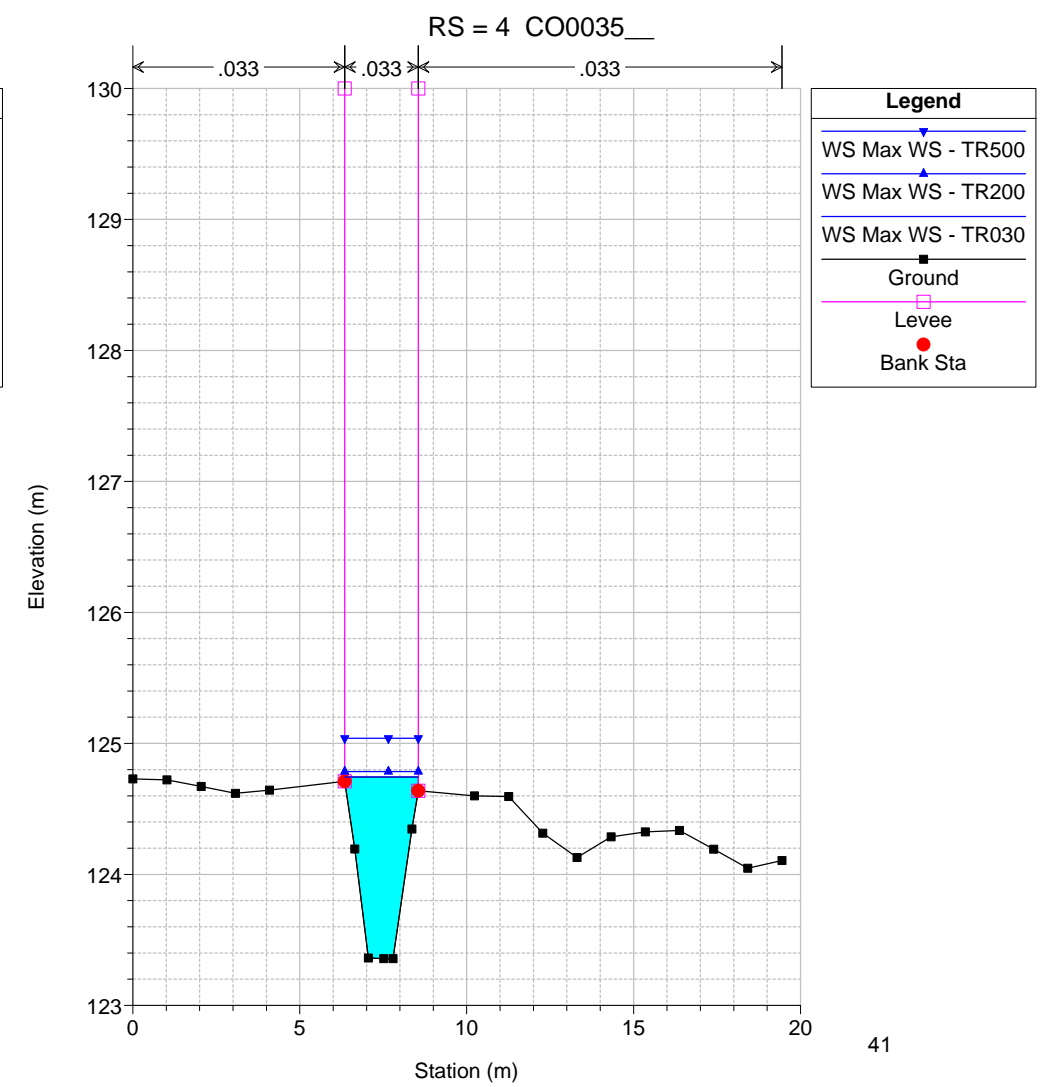
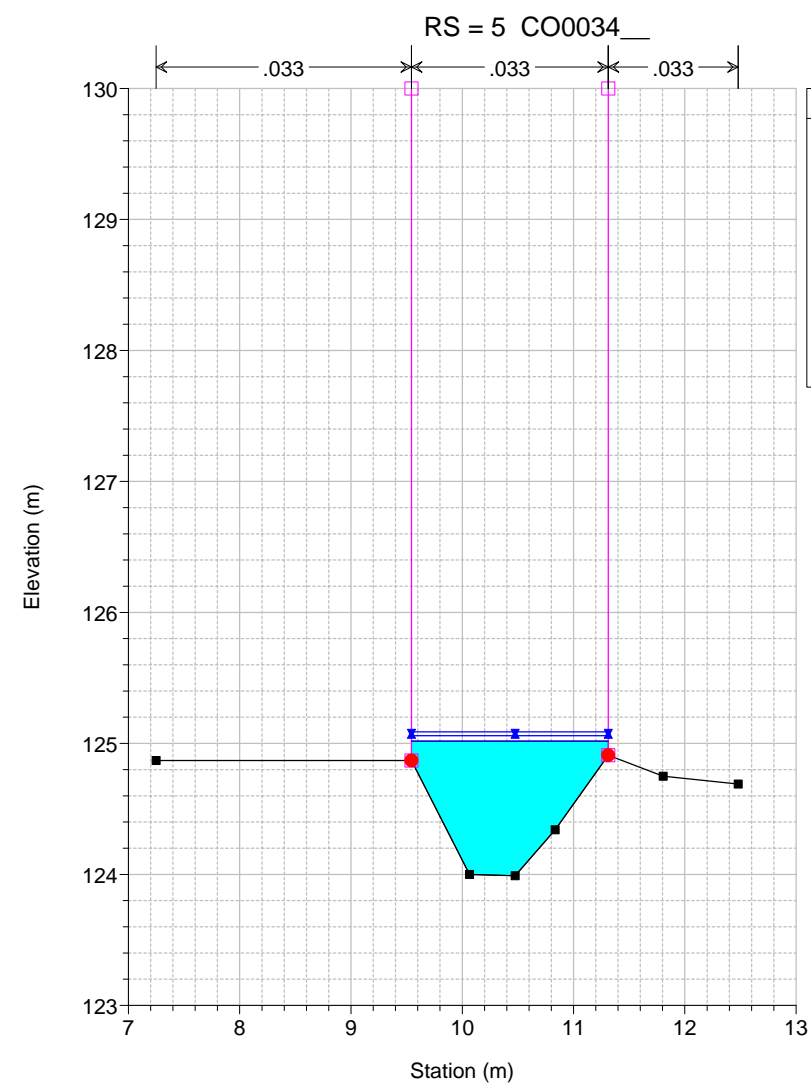
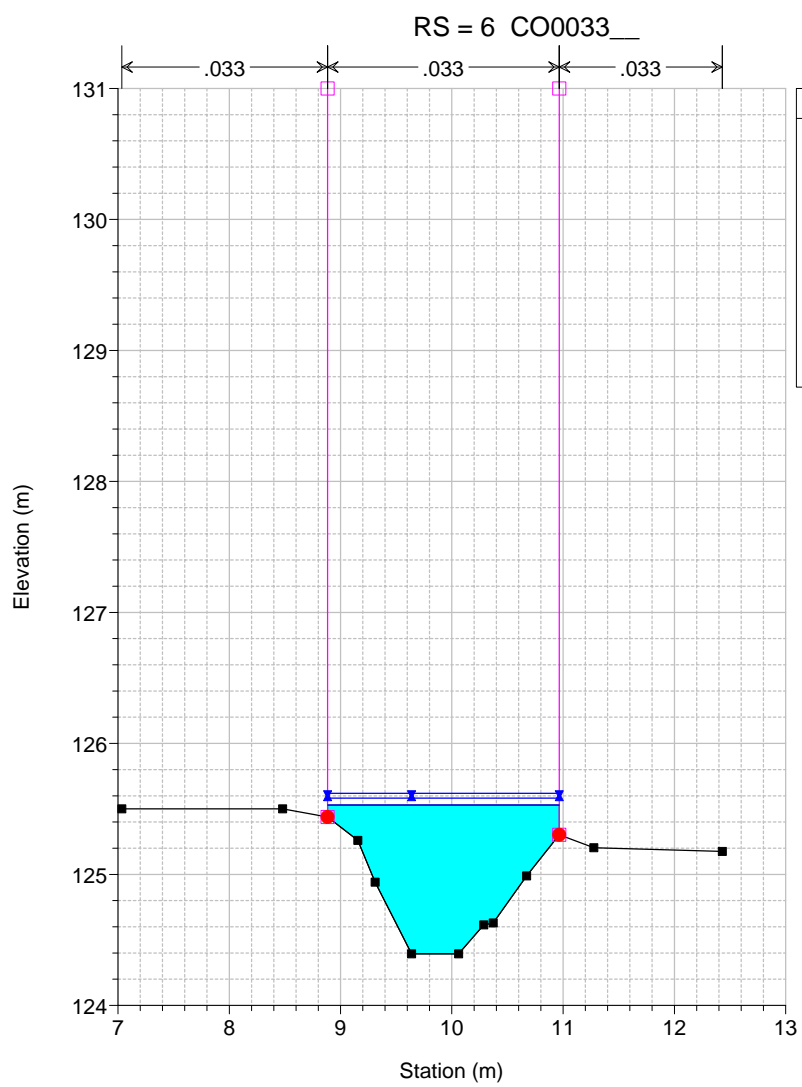
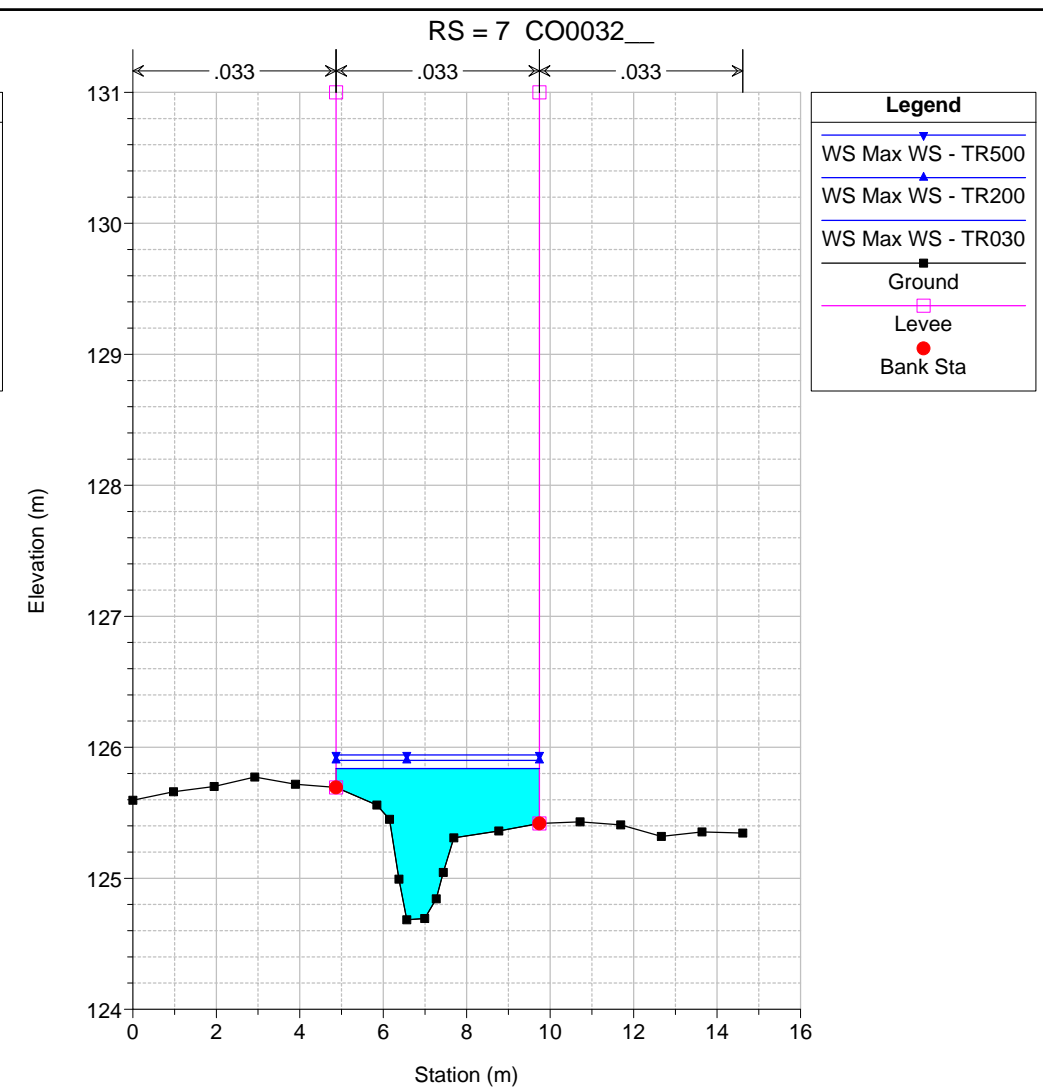
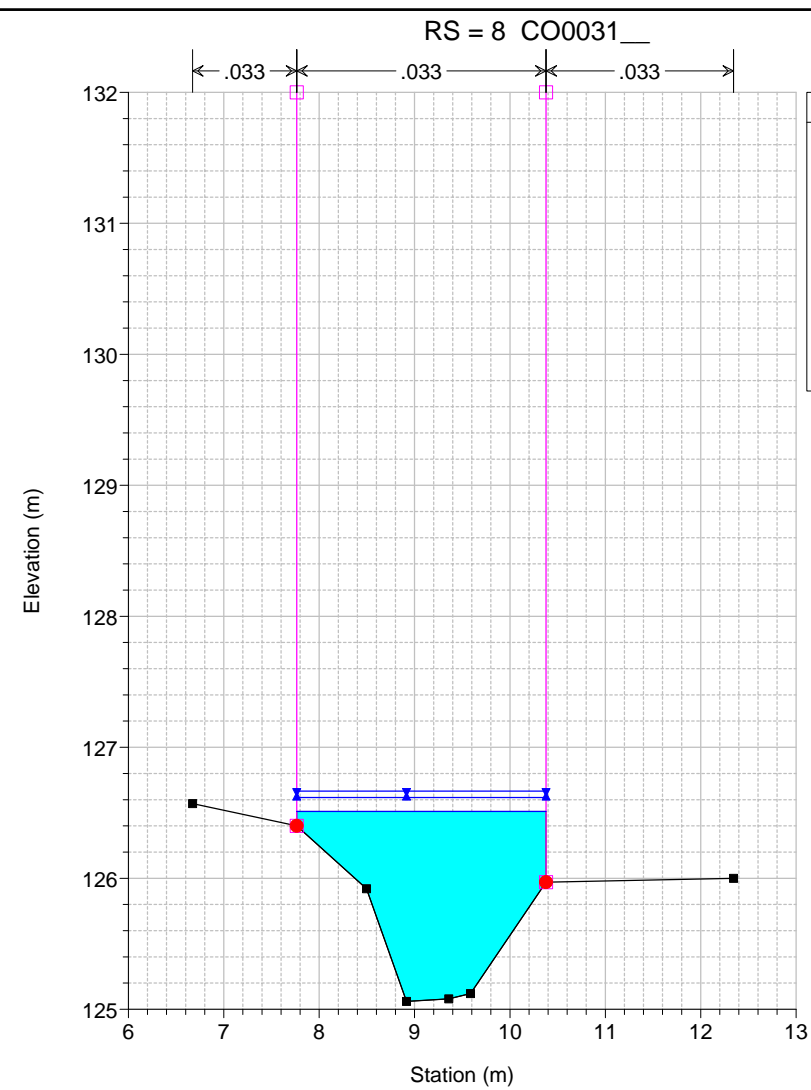
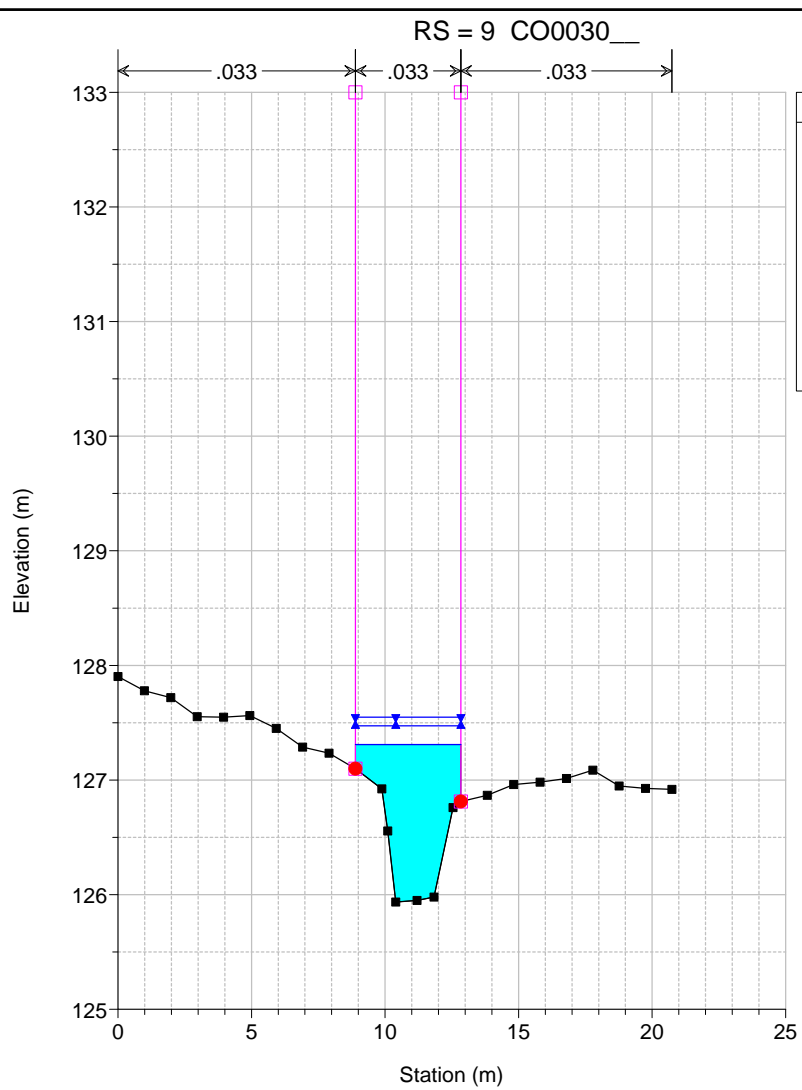

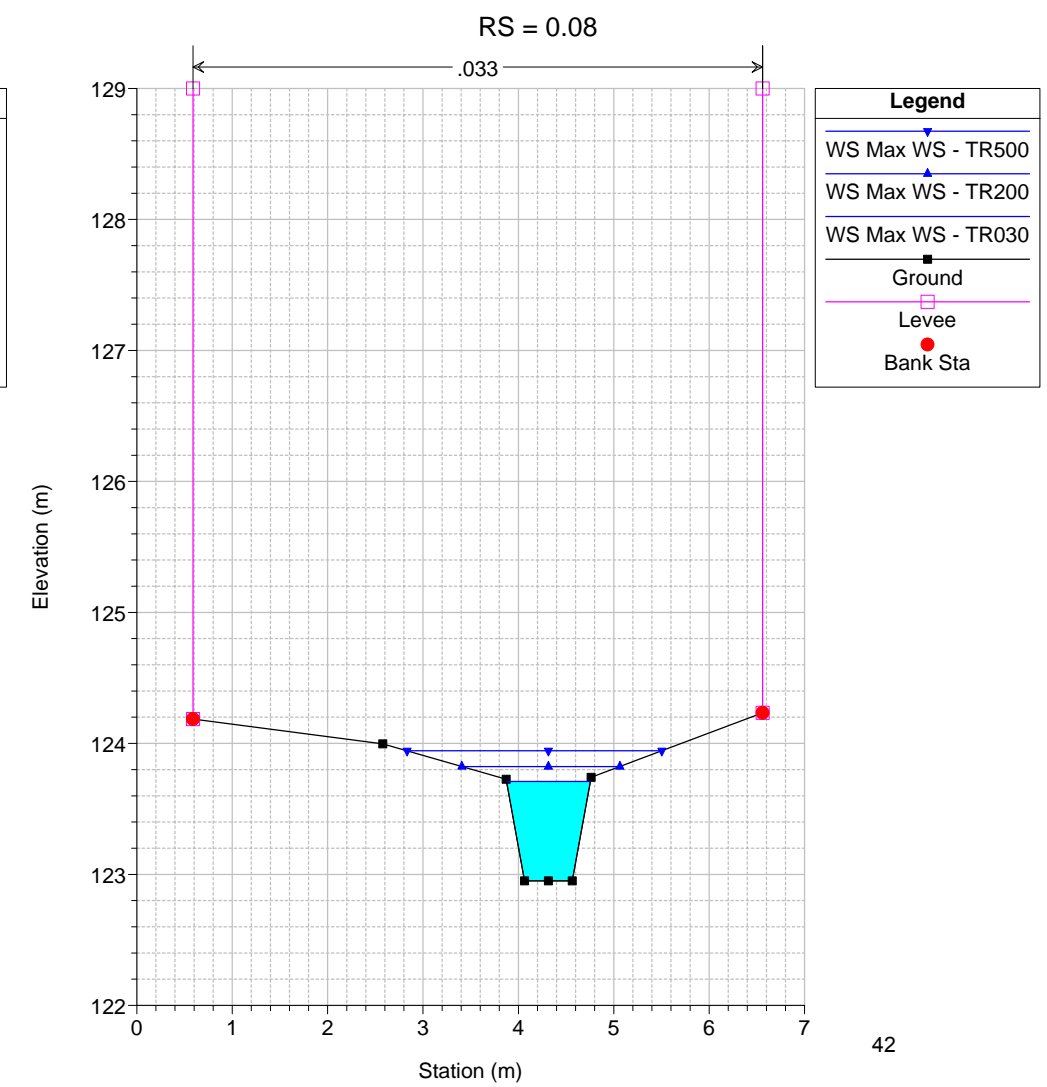
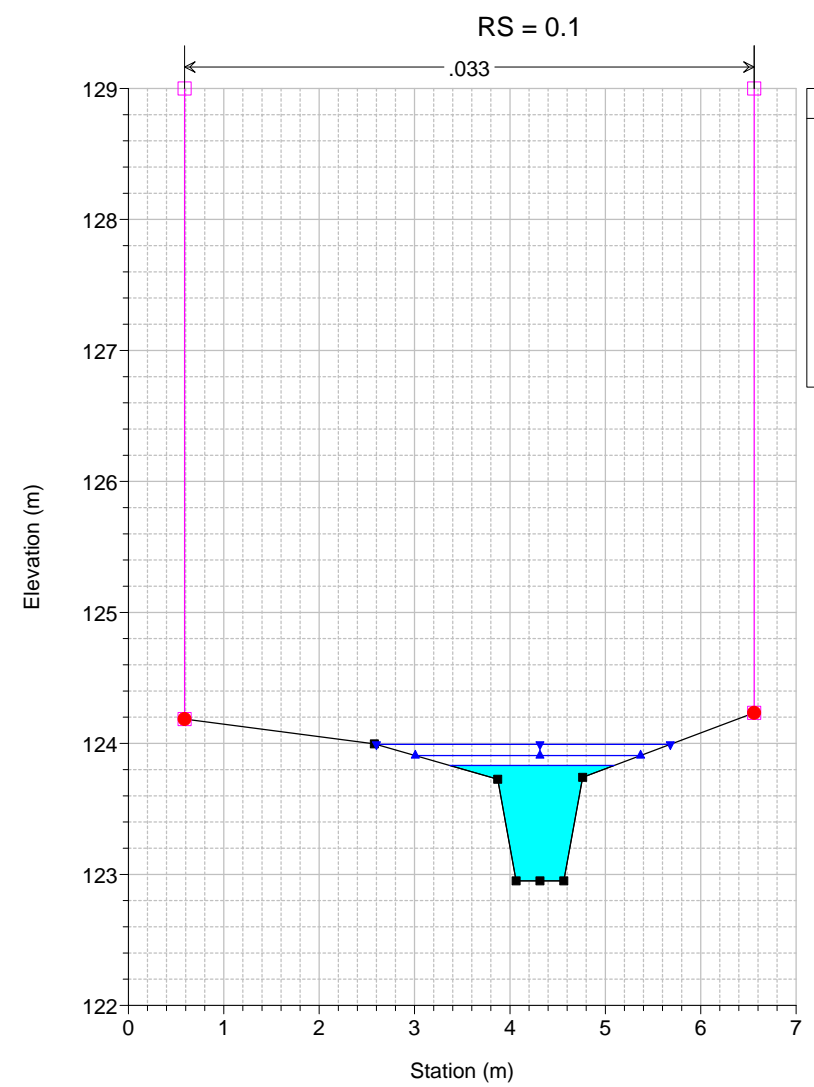
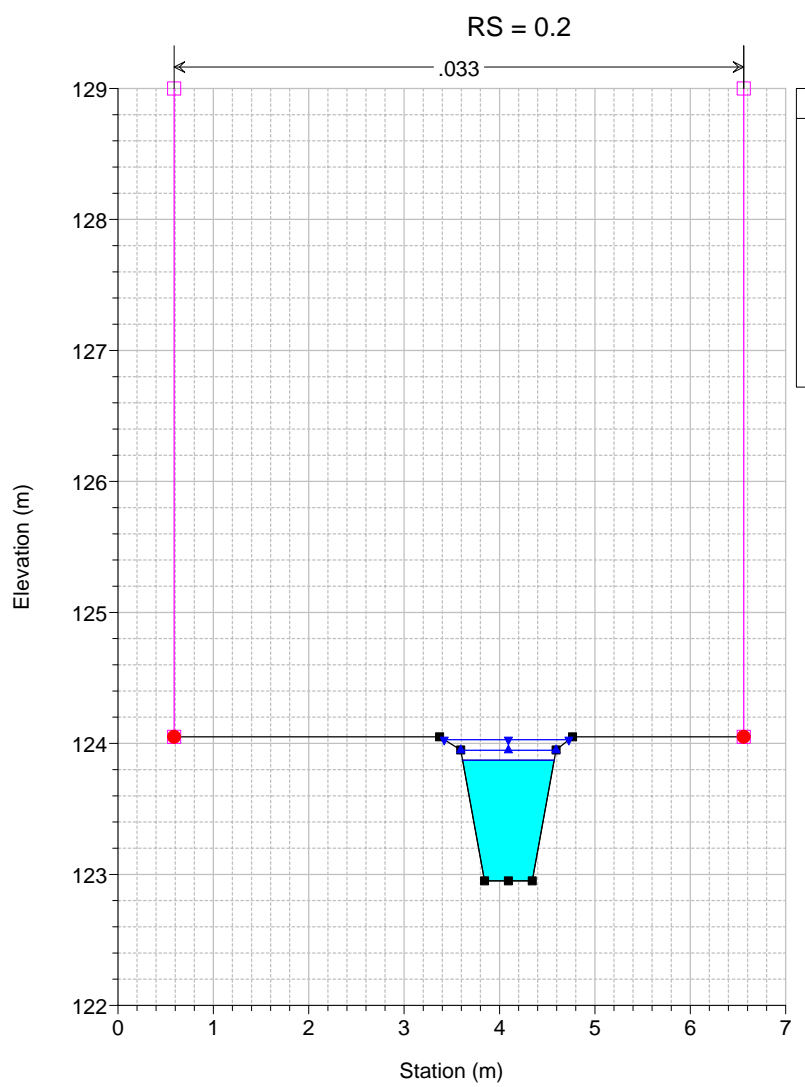
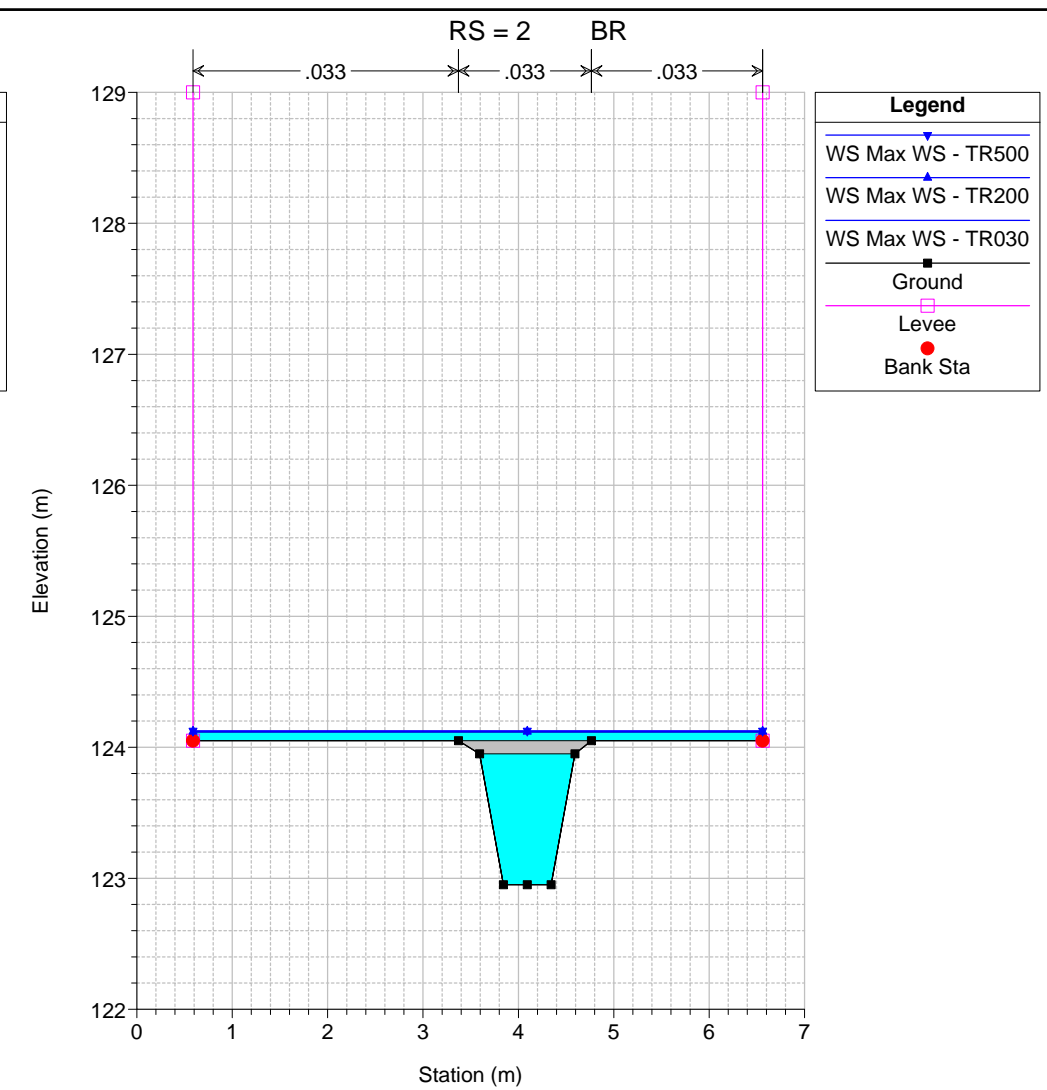
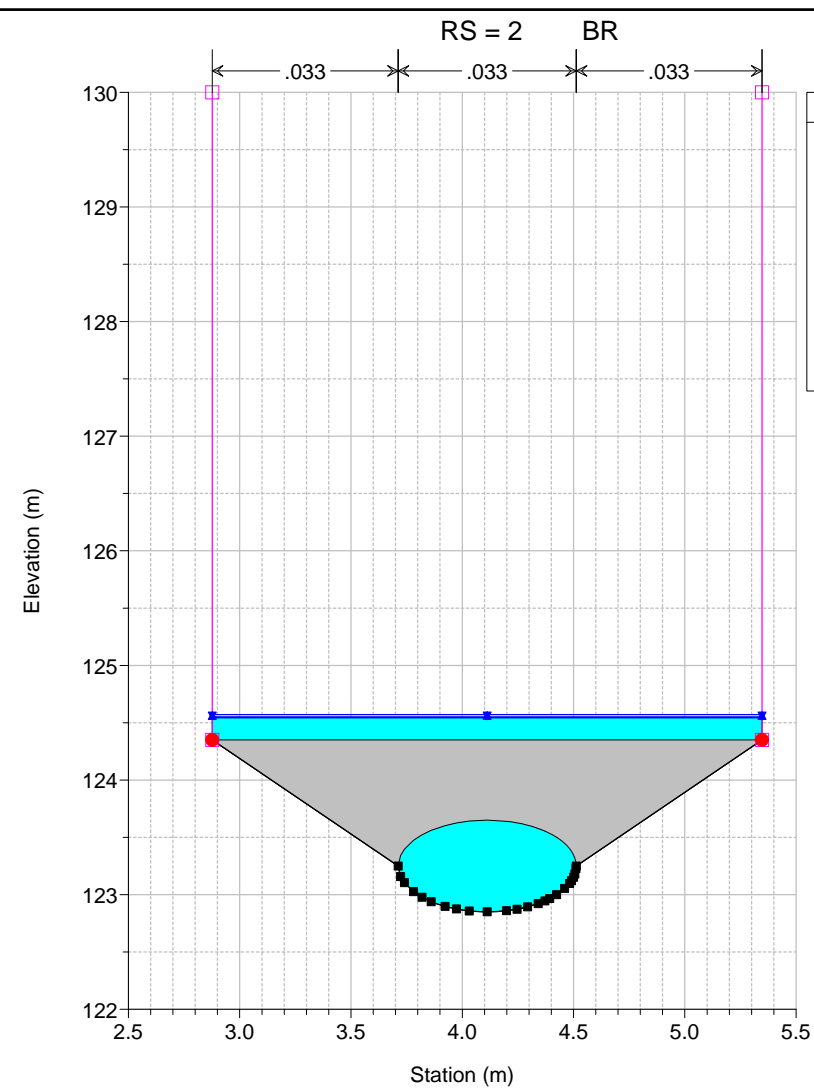
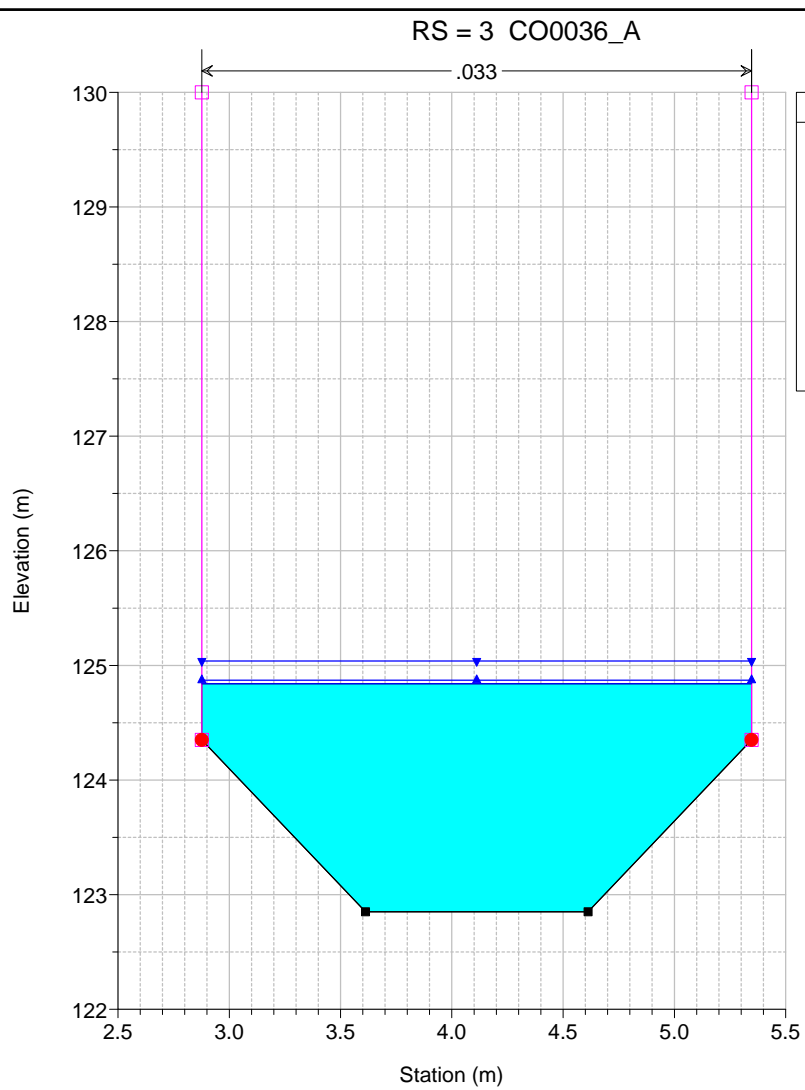

Sezioni fluviali
Borro Colmate, tratto a valle della confluenza con il diversivo
Tempo di ritorno: 30, 200 e 500 anni

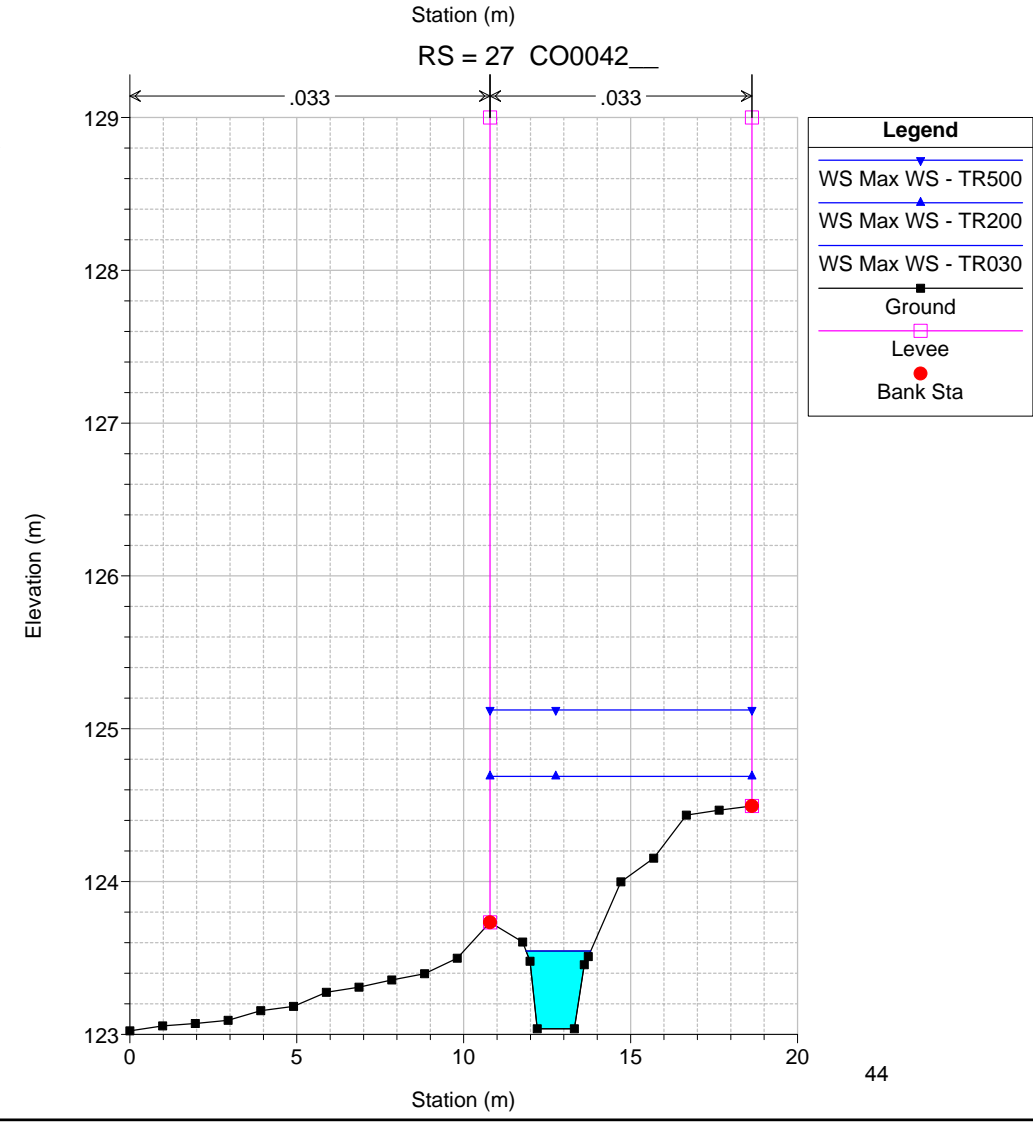
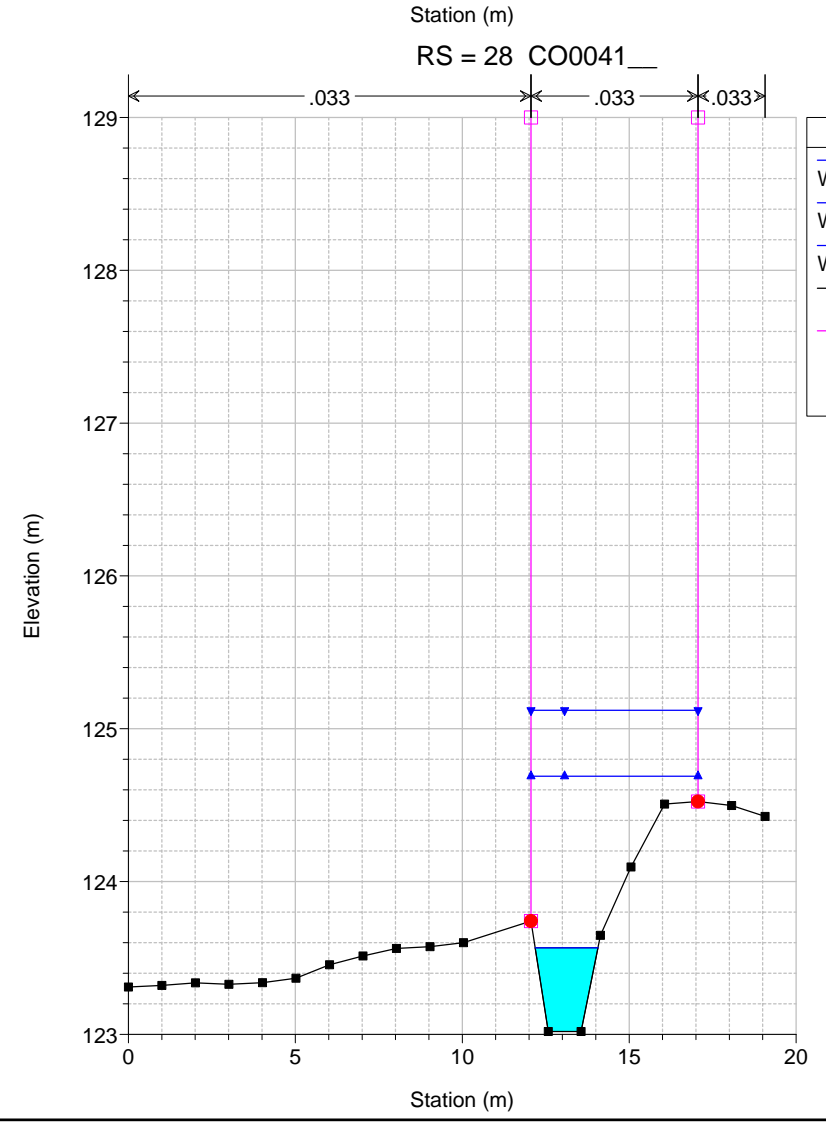
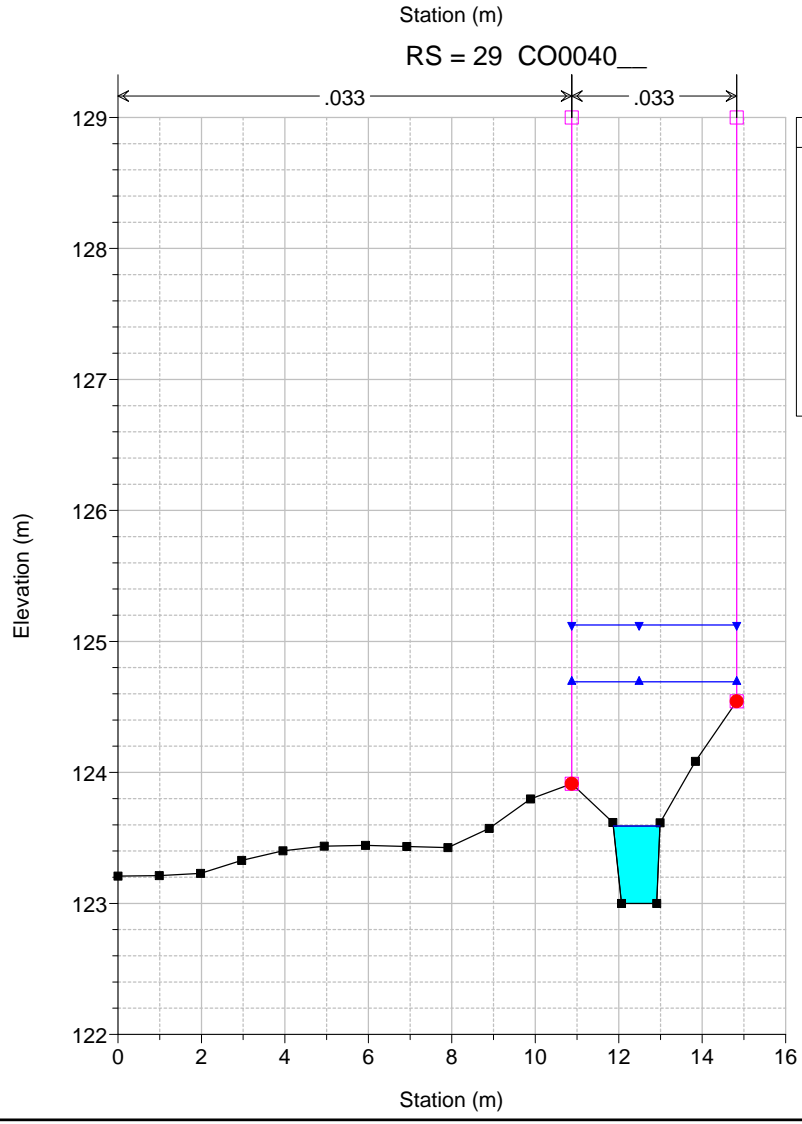
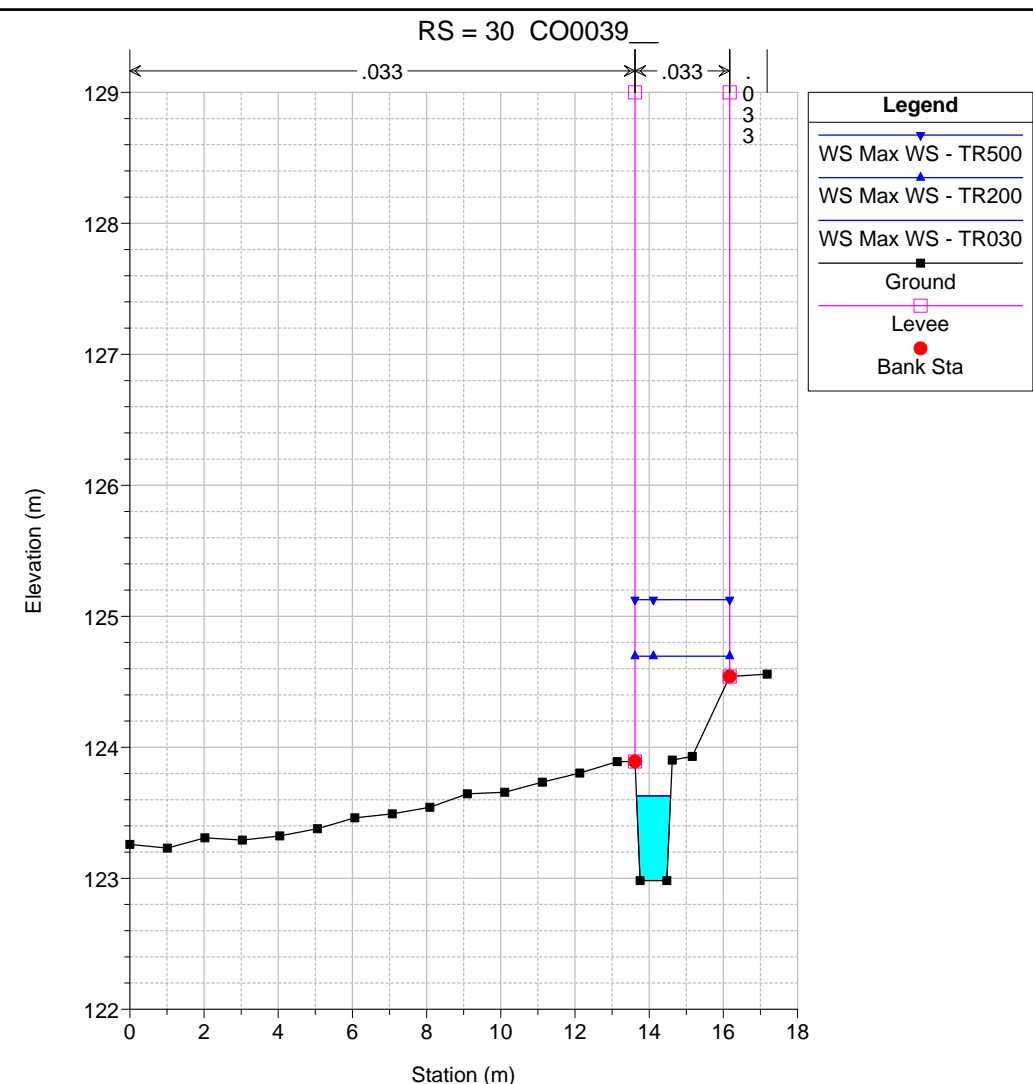
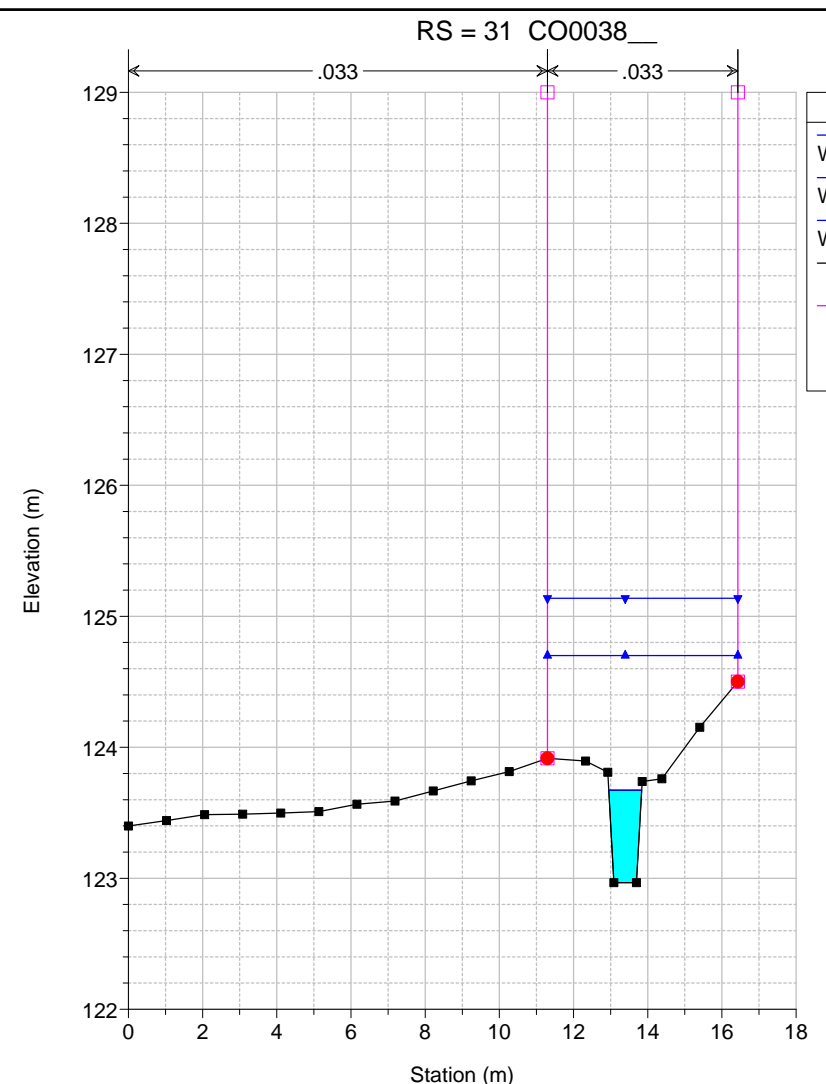
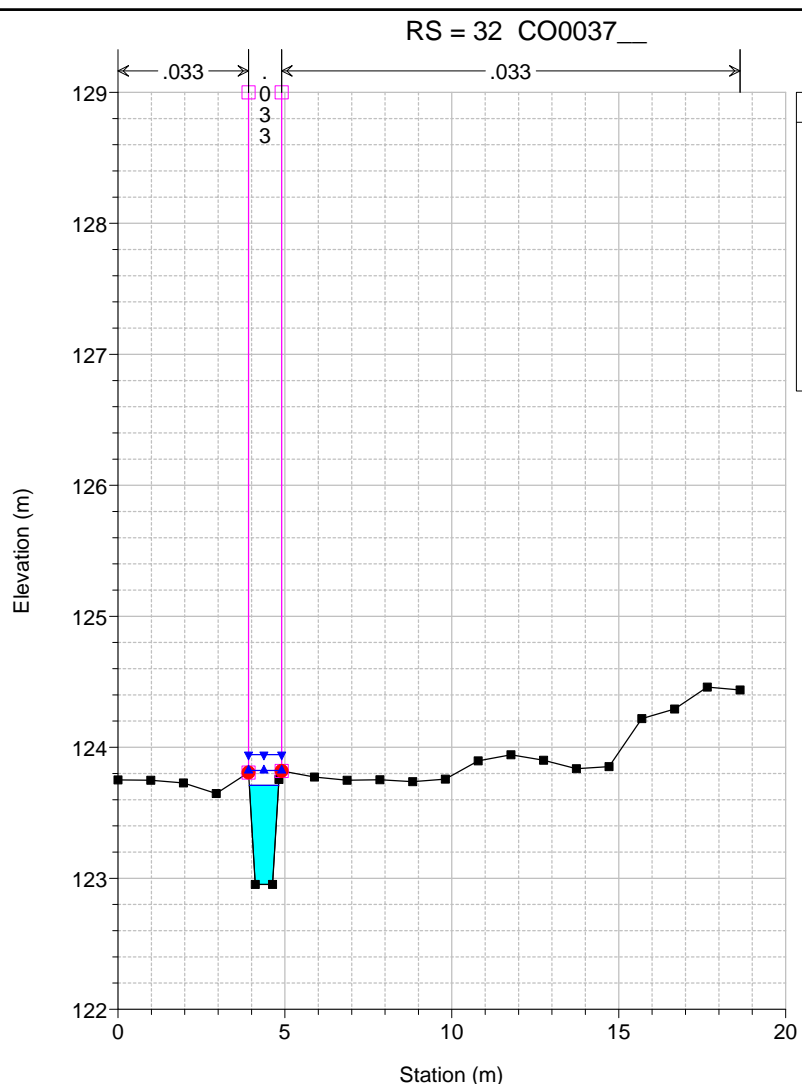

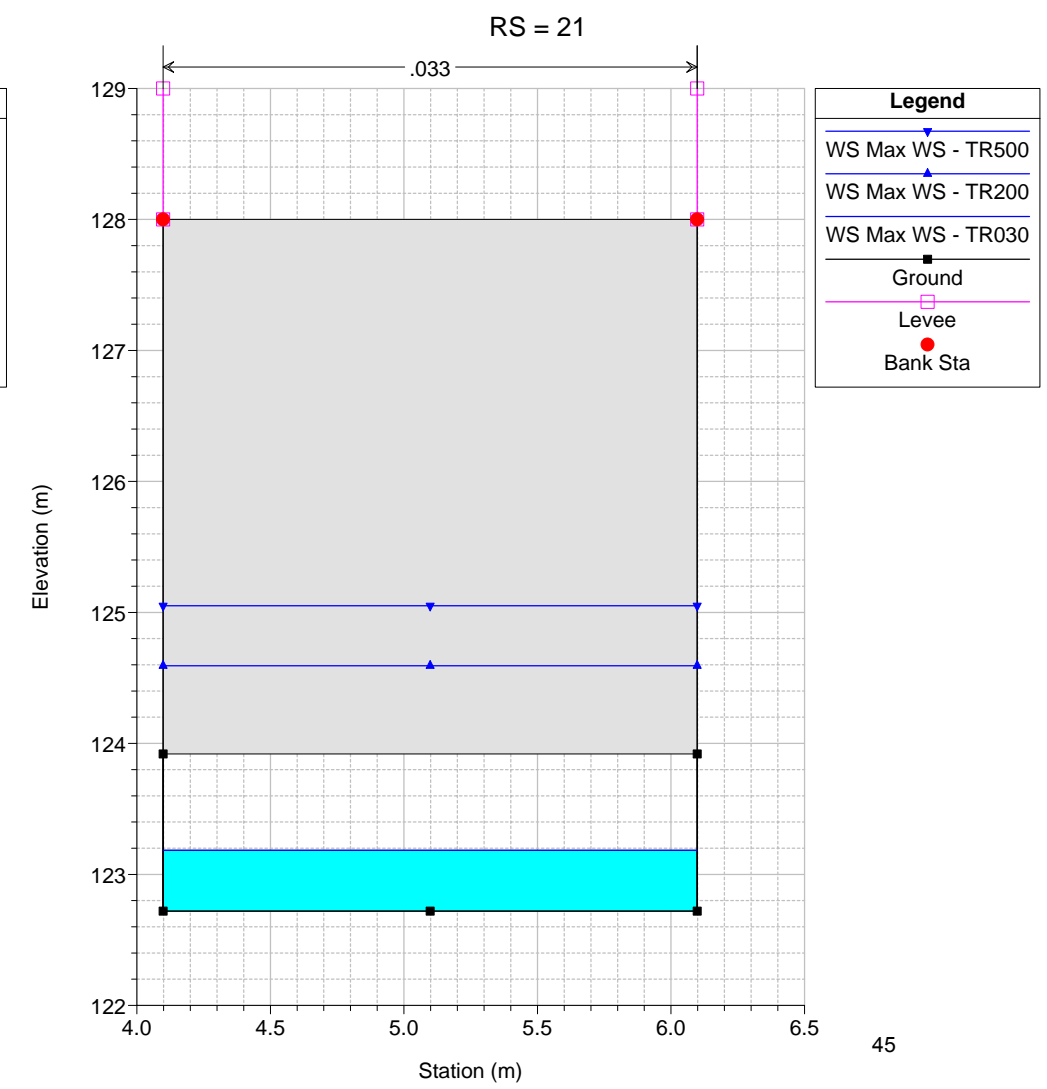
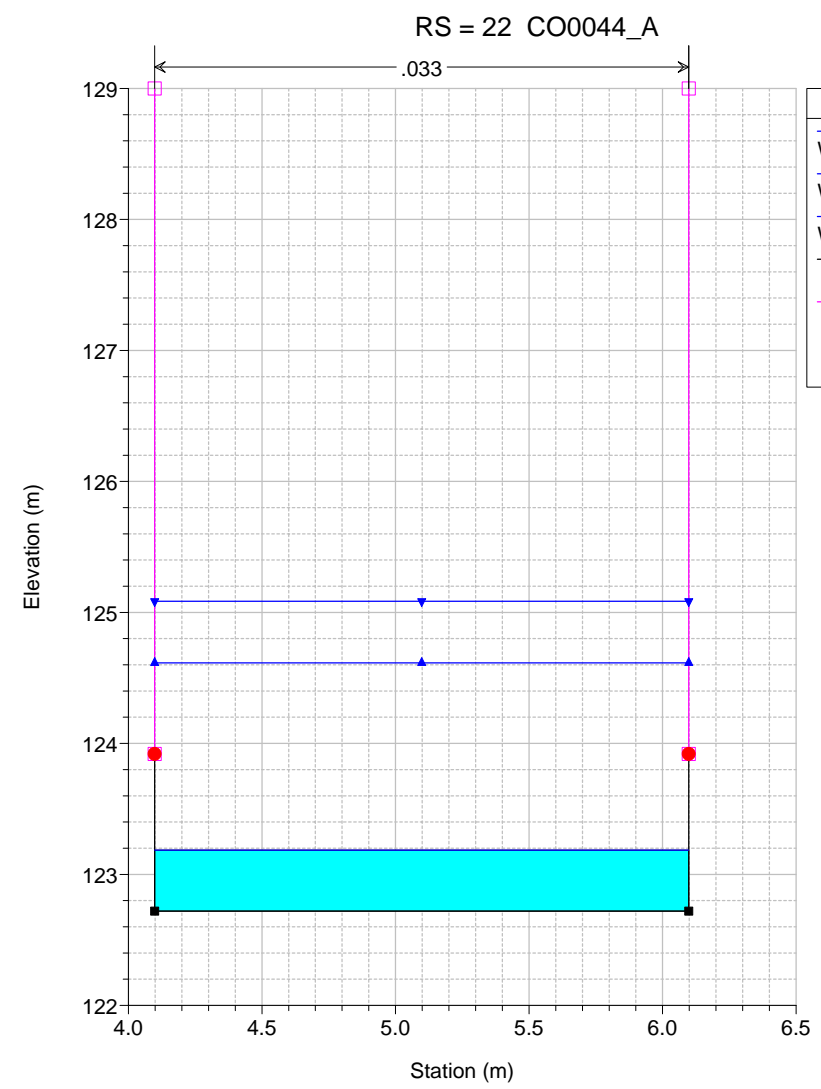
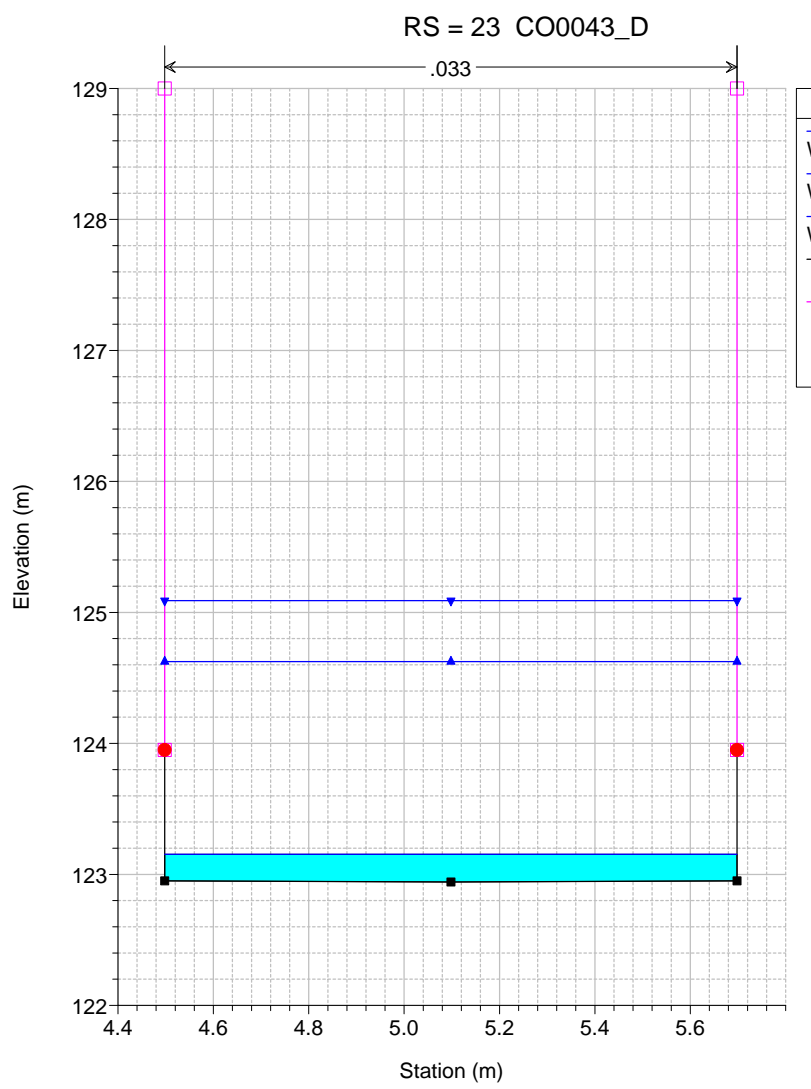
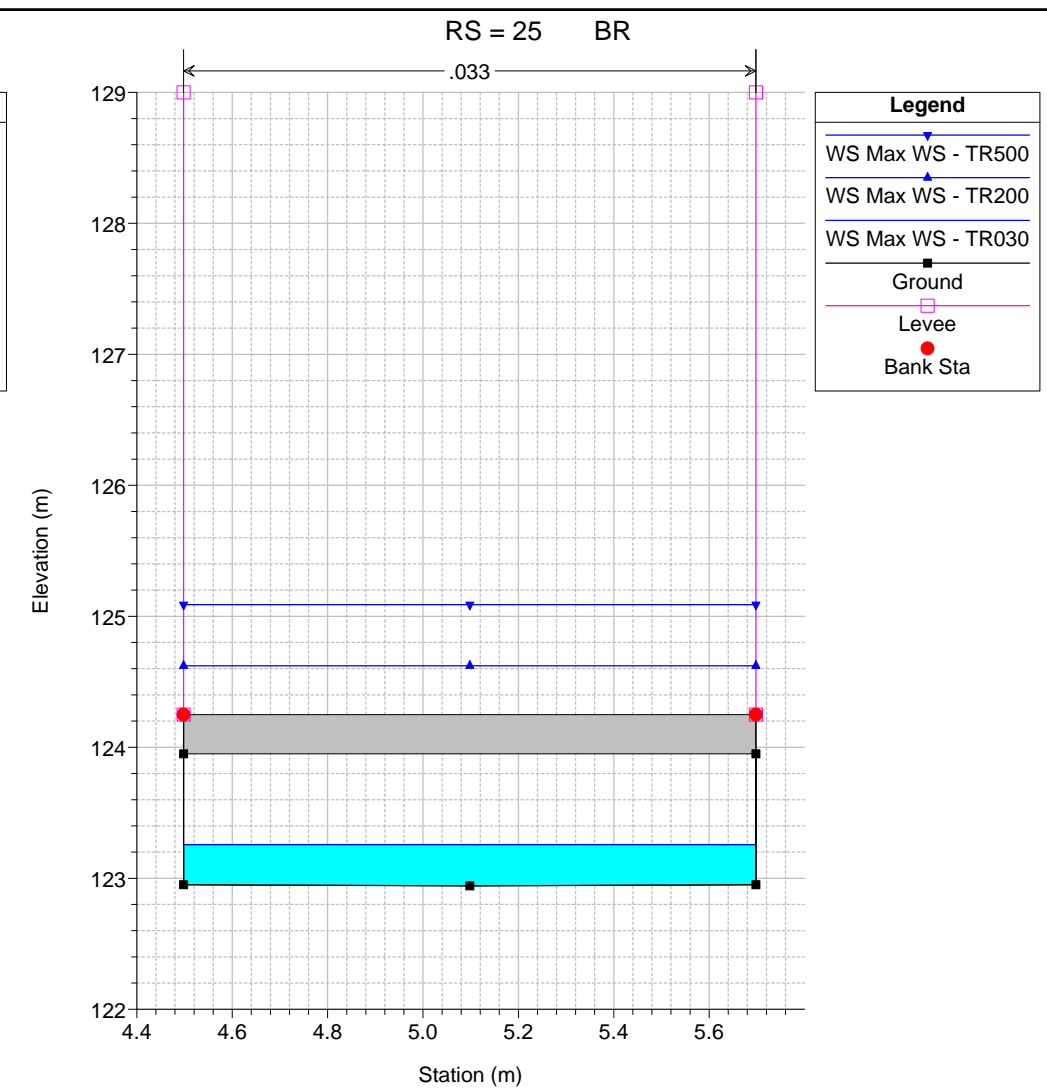
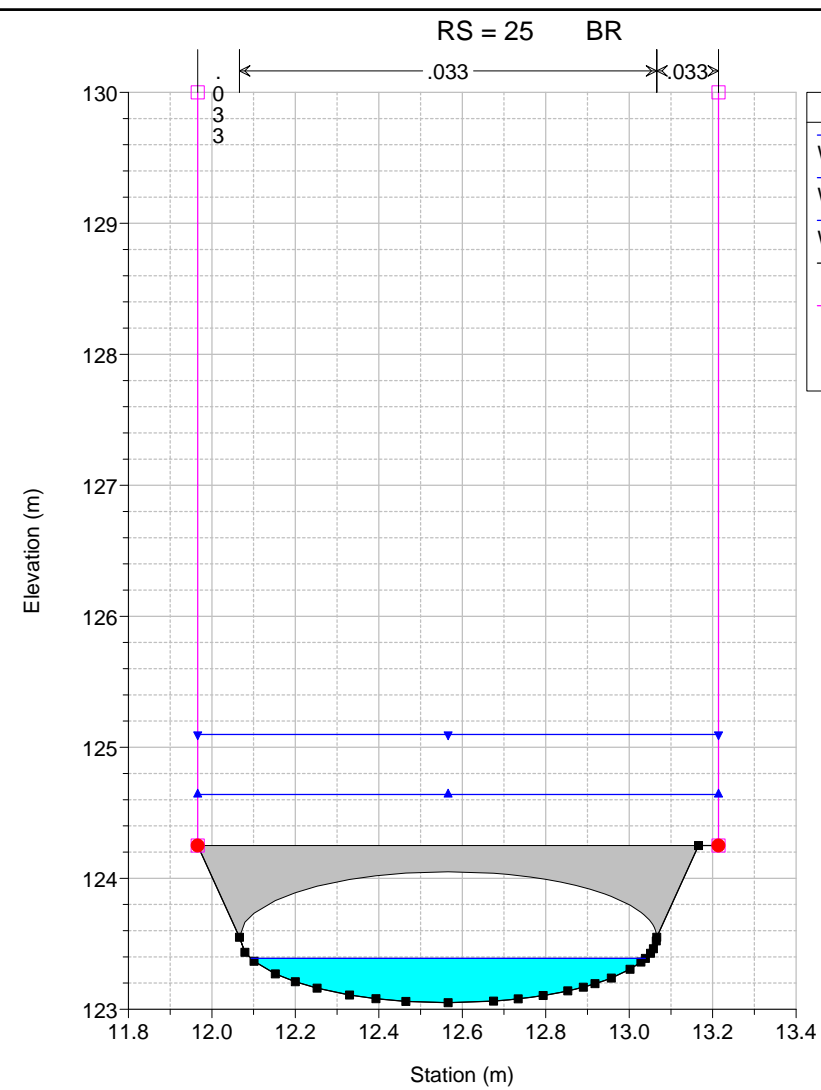
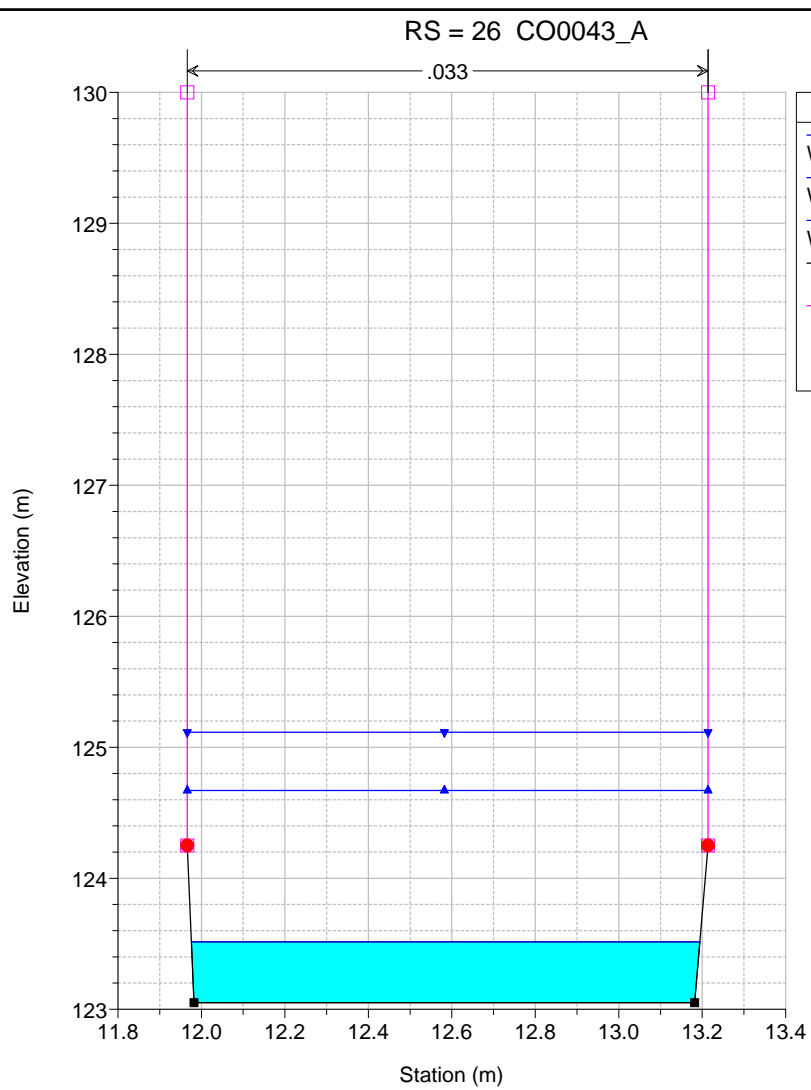

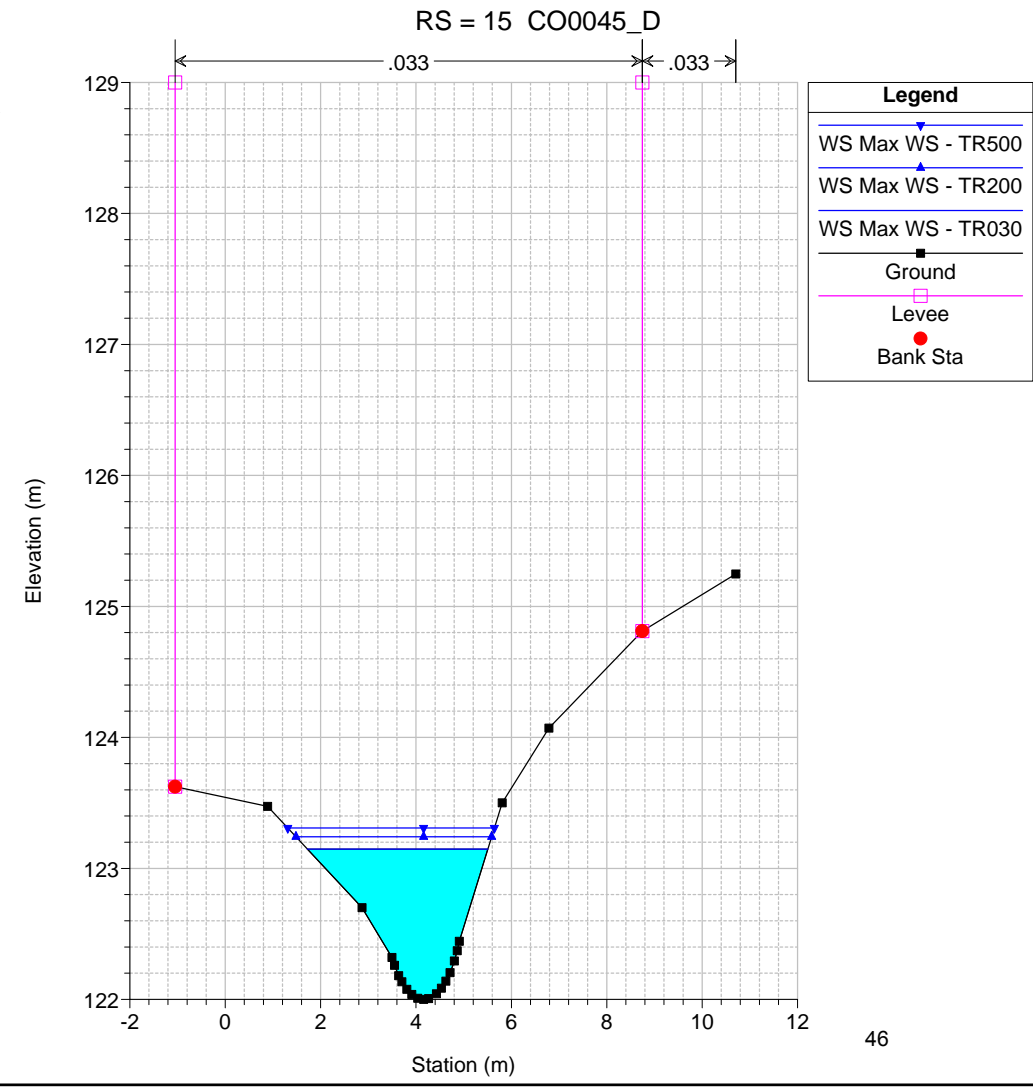
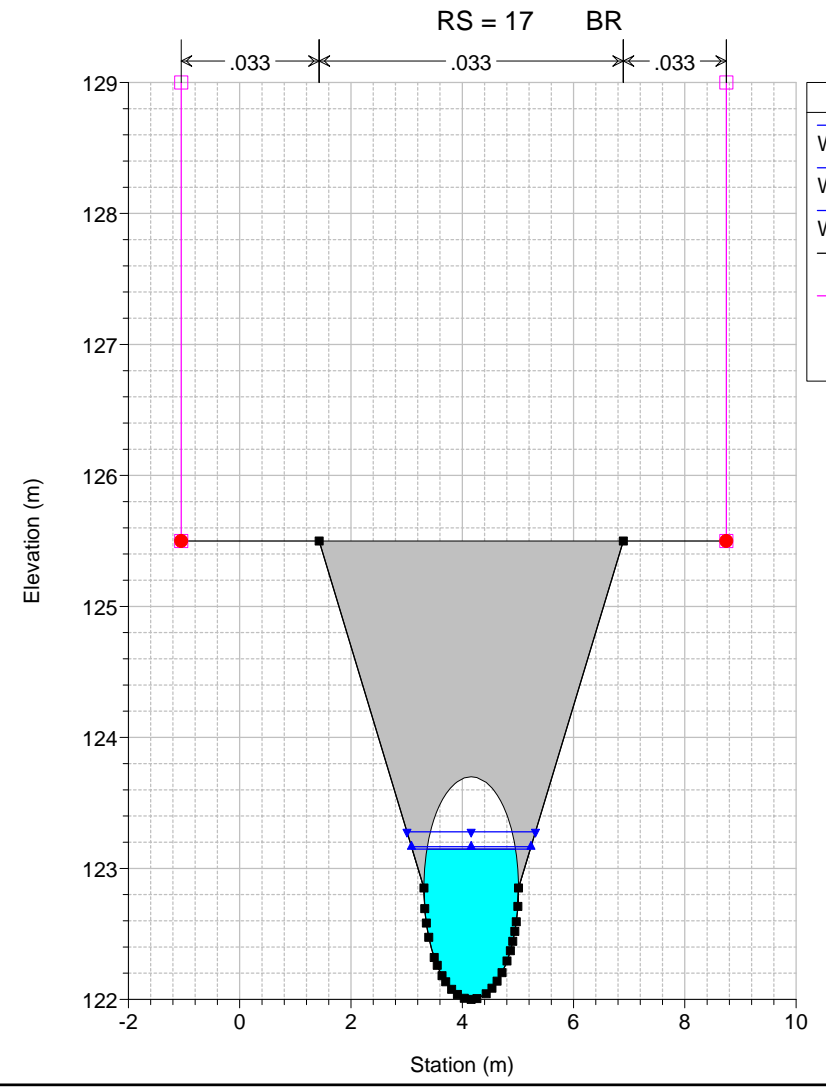
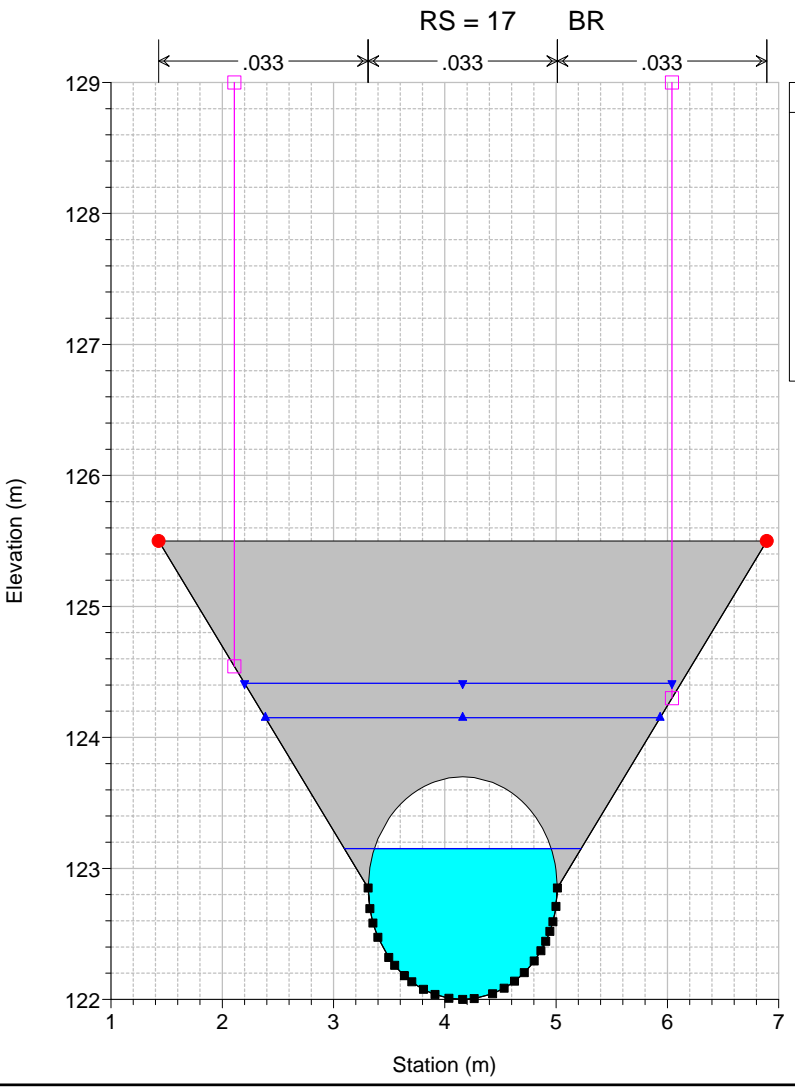
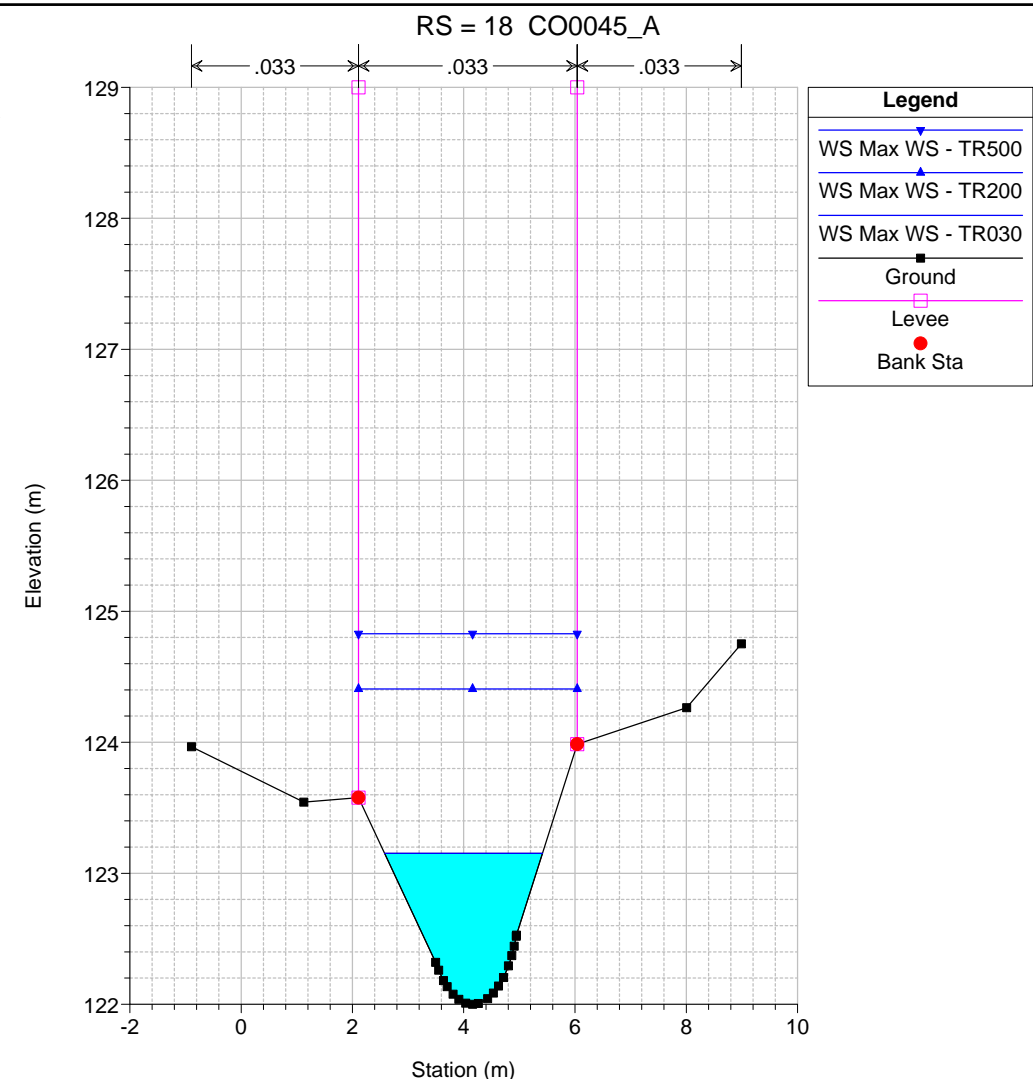
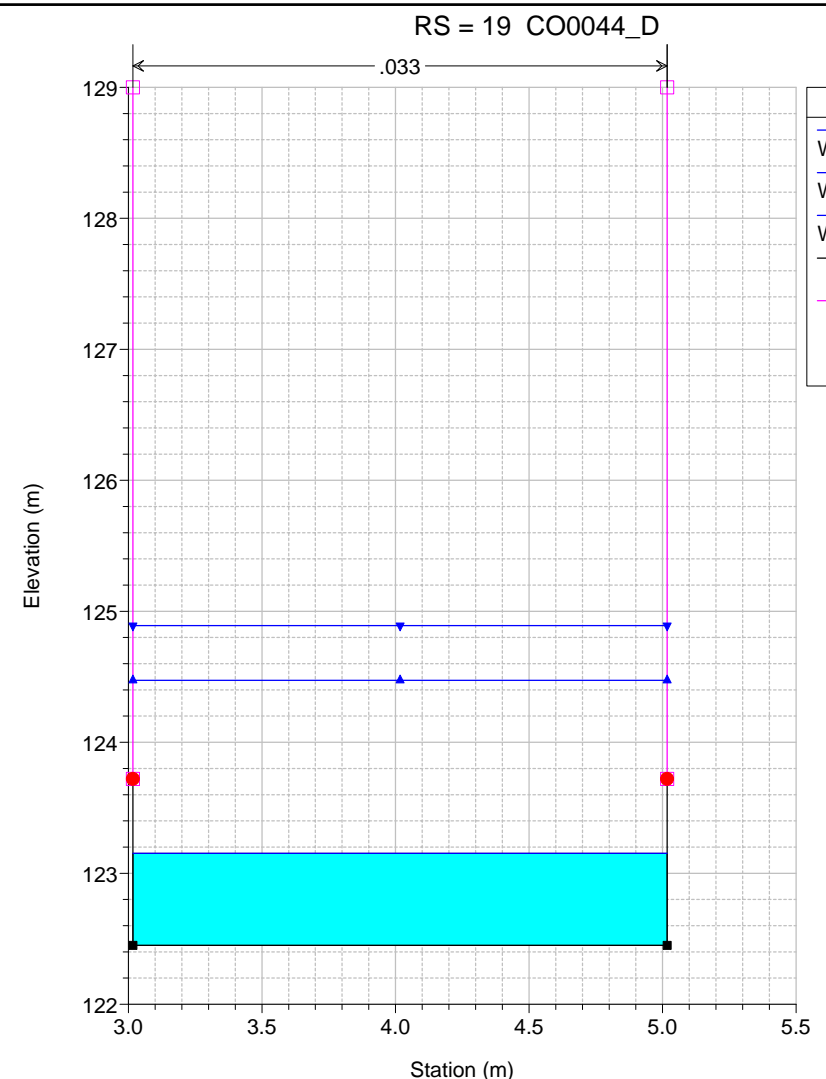
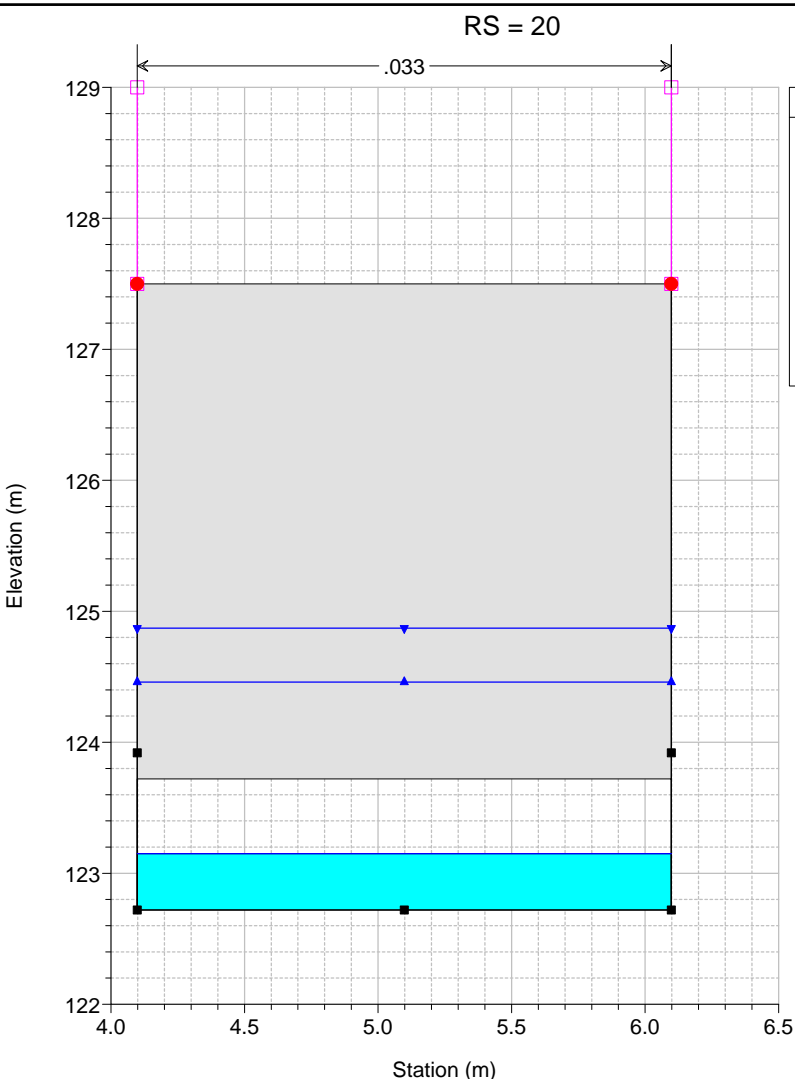

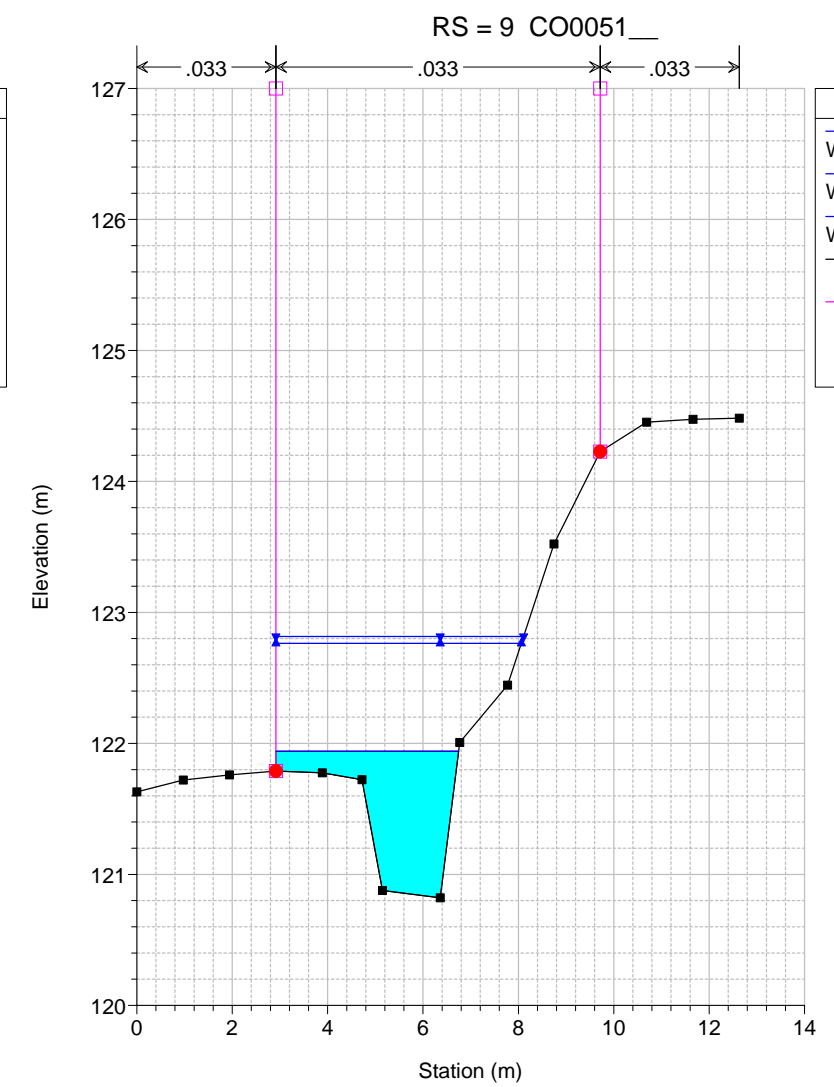
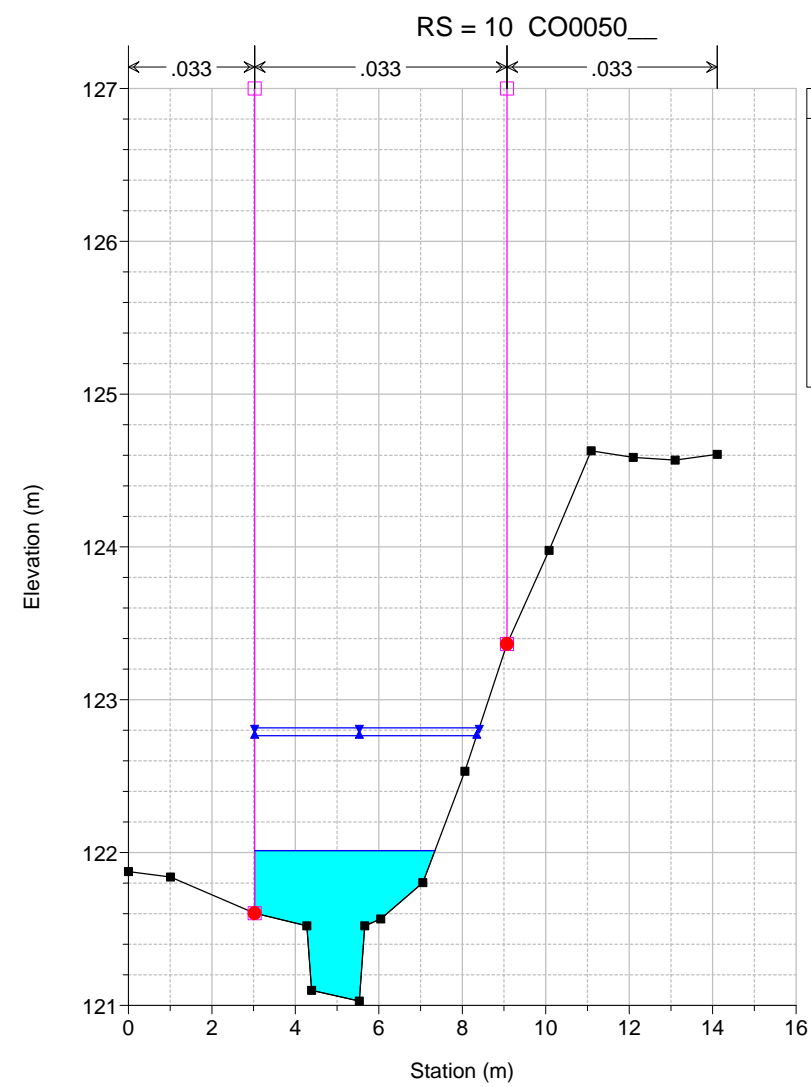
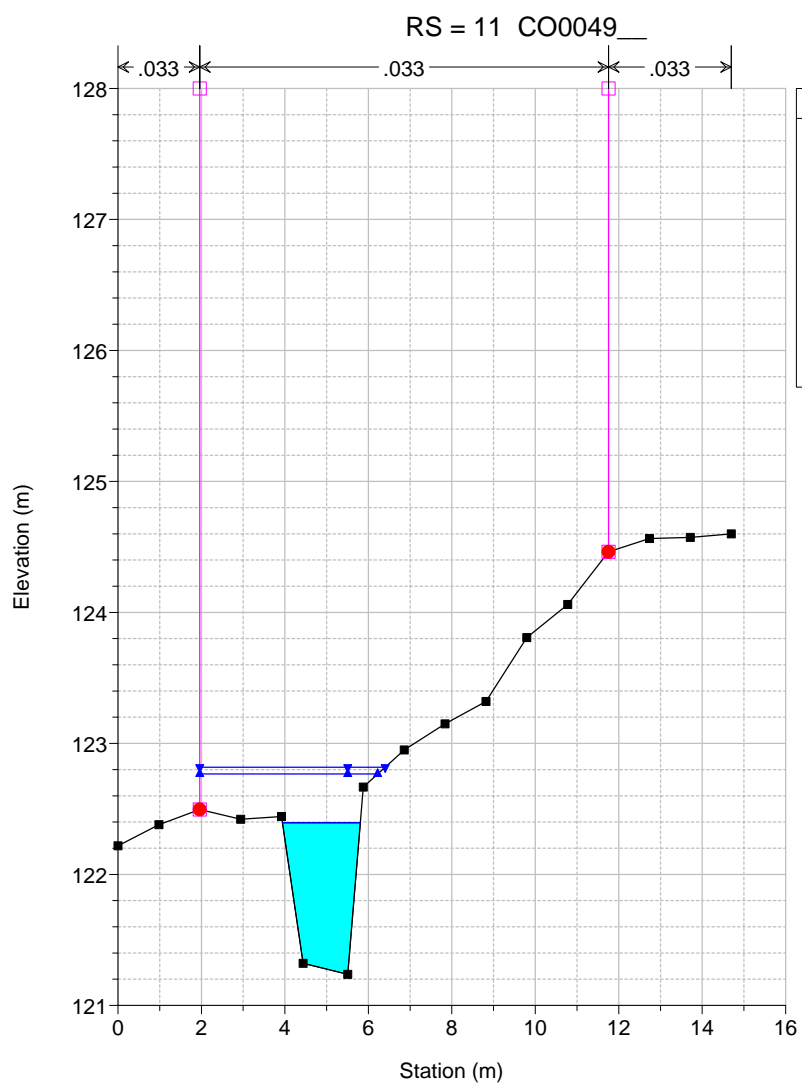
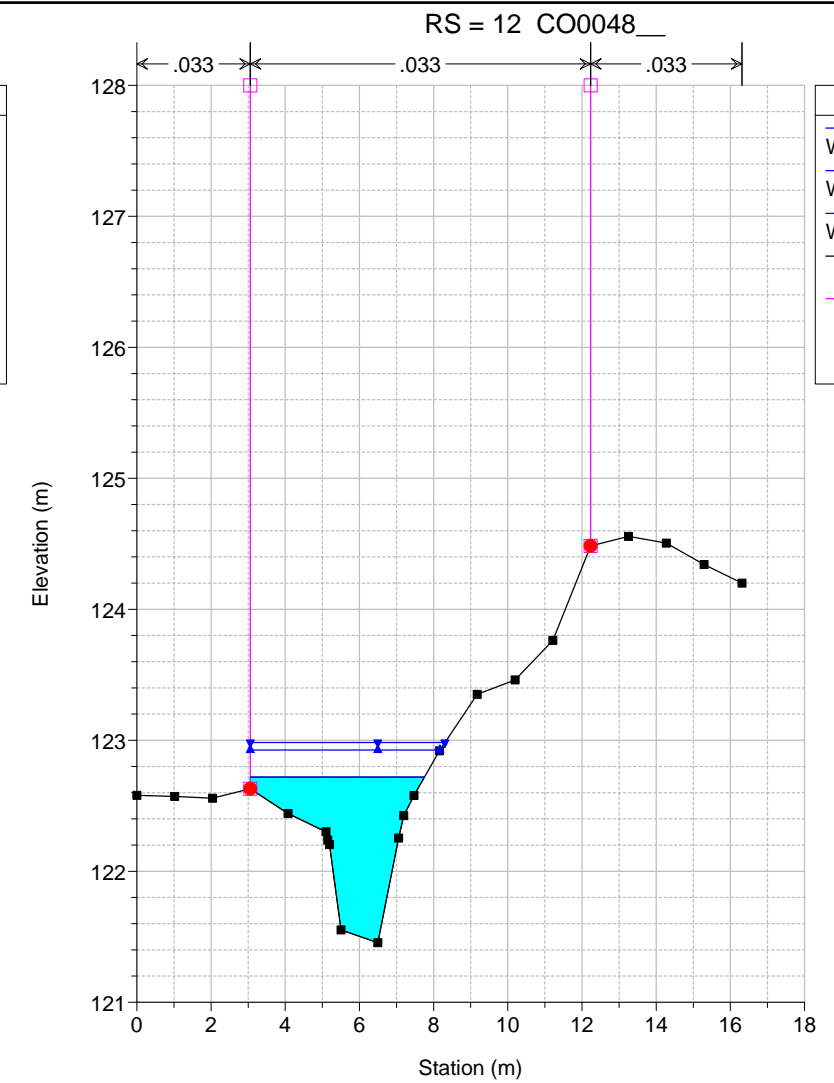
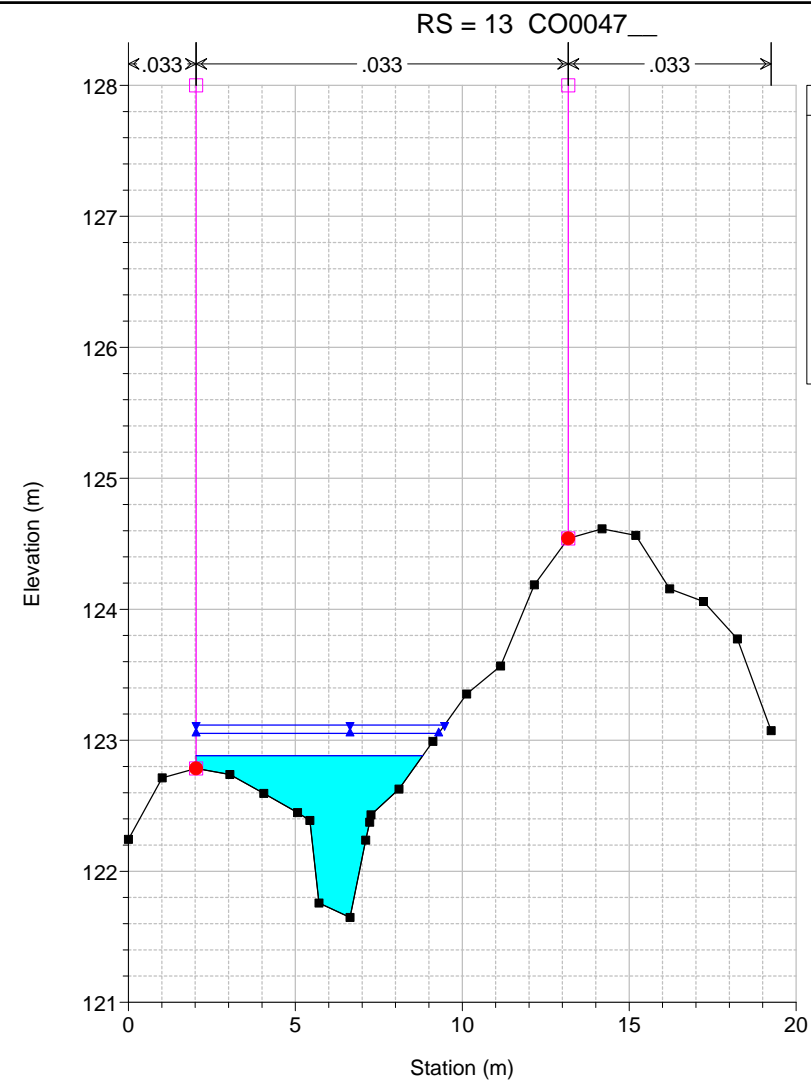
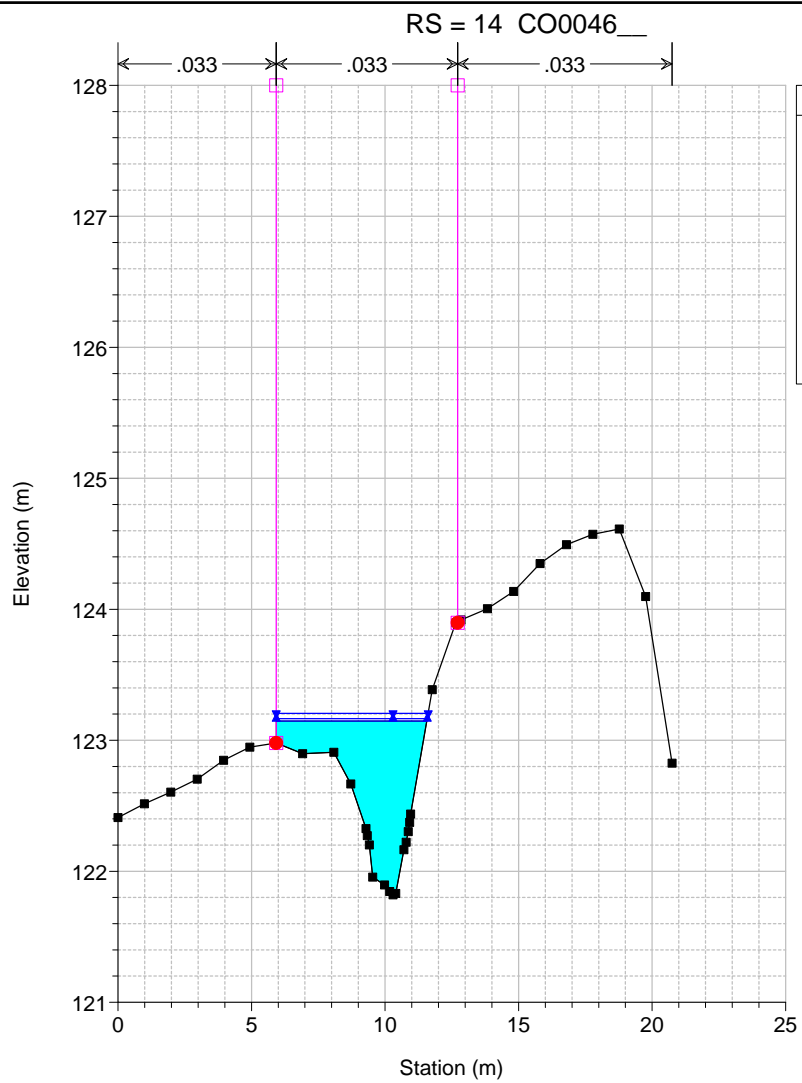

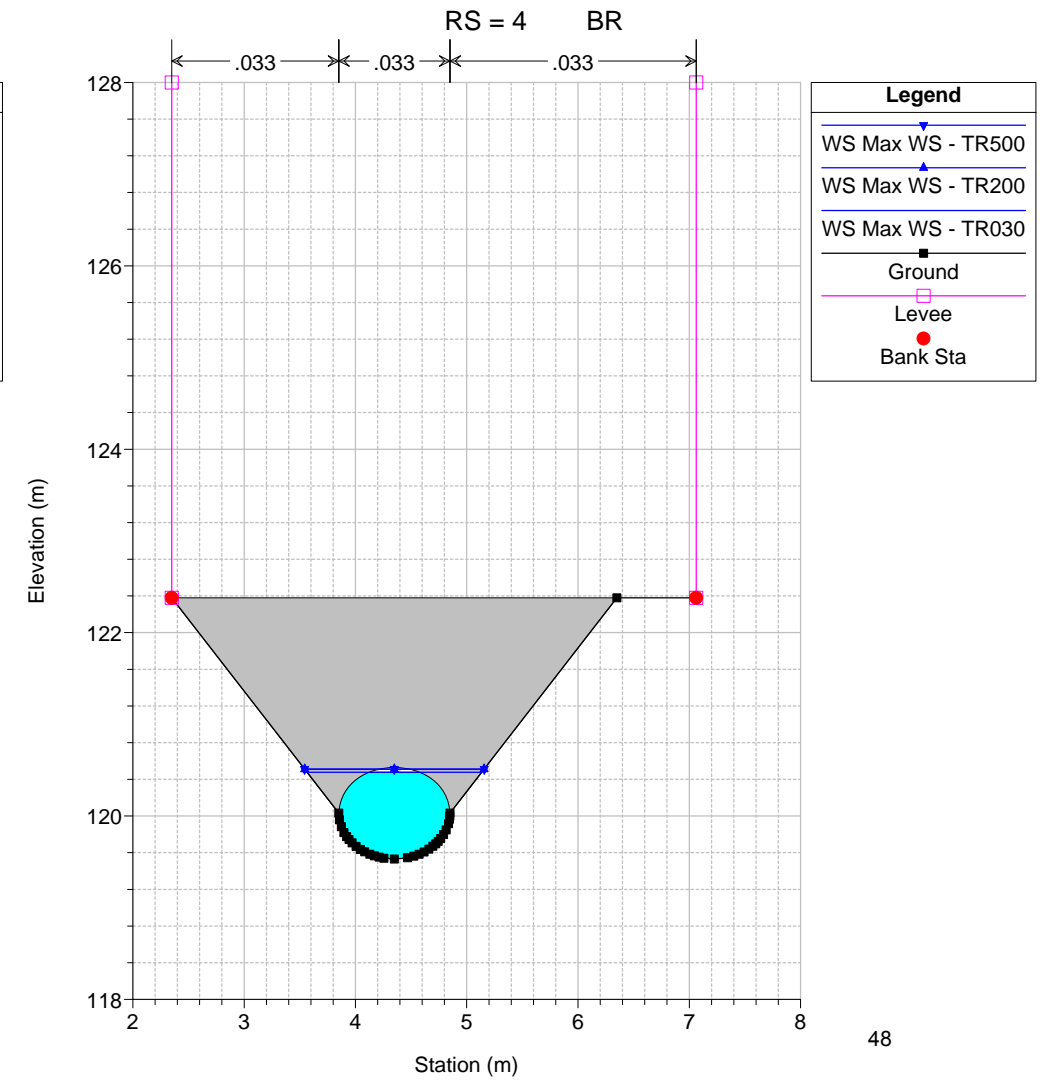
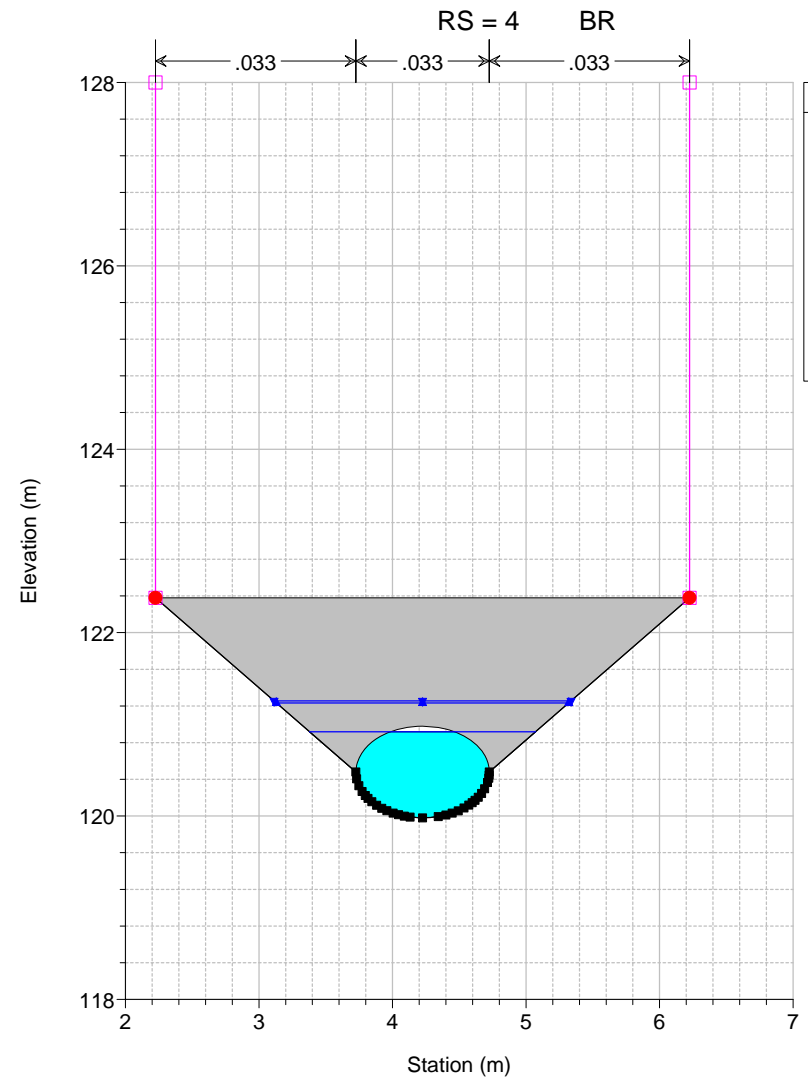
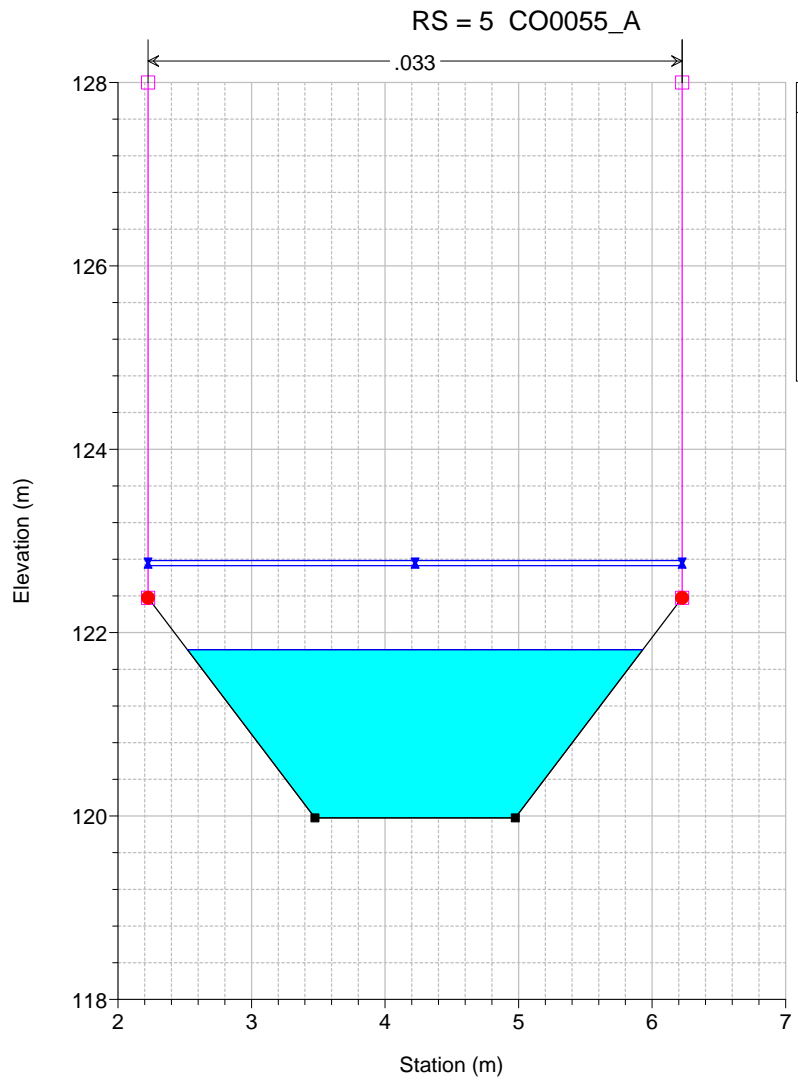
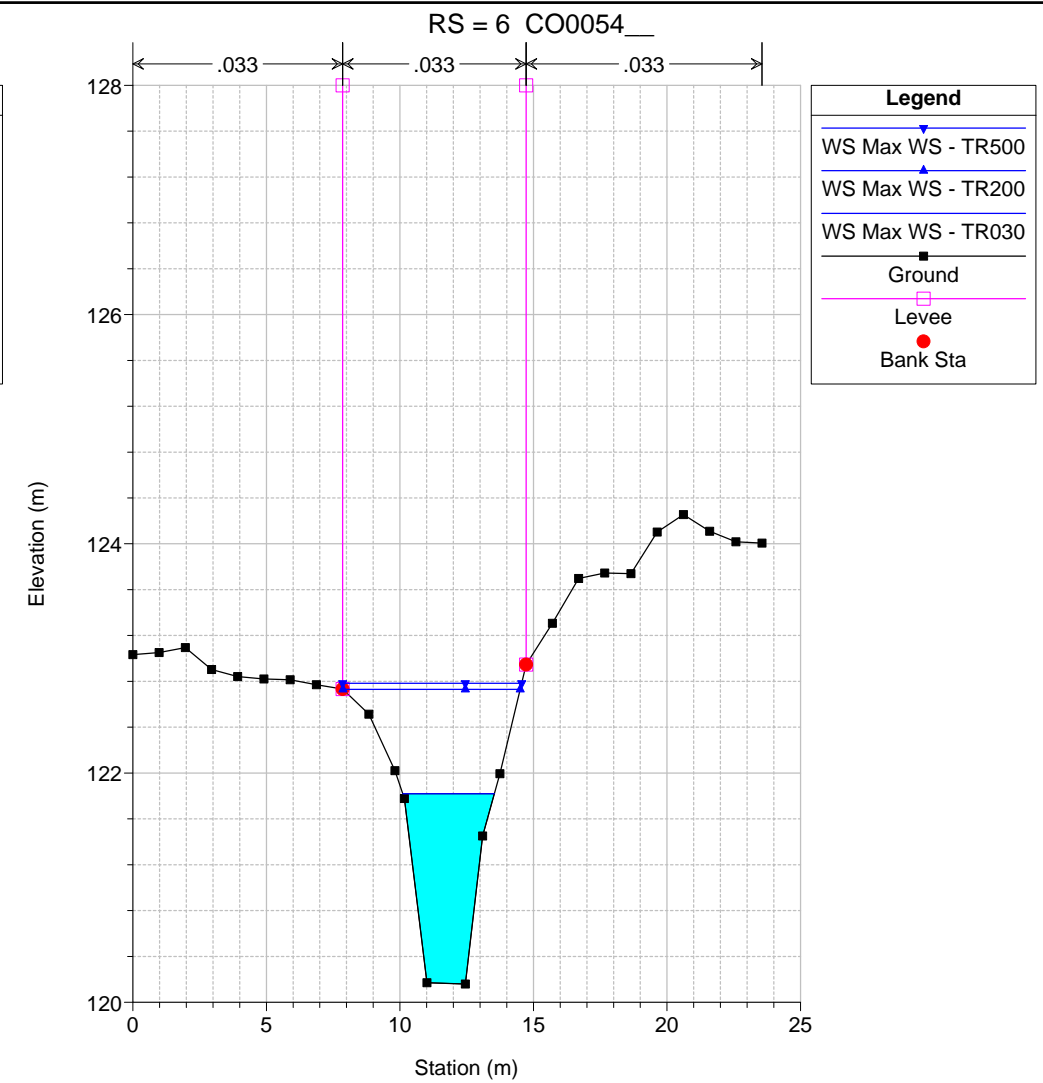
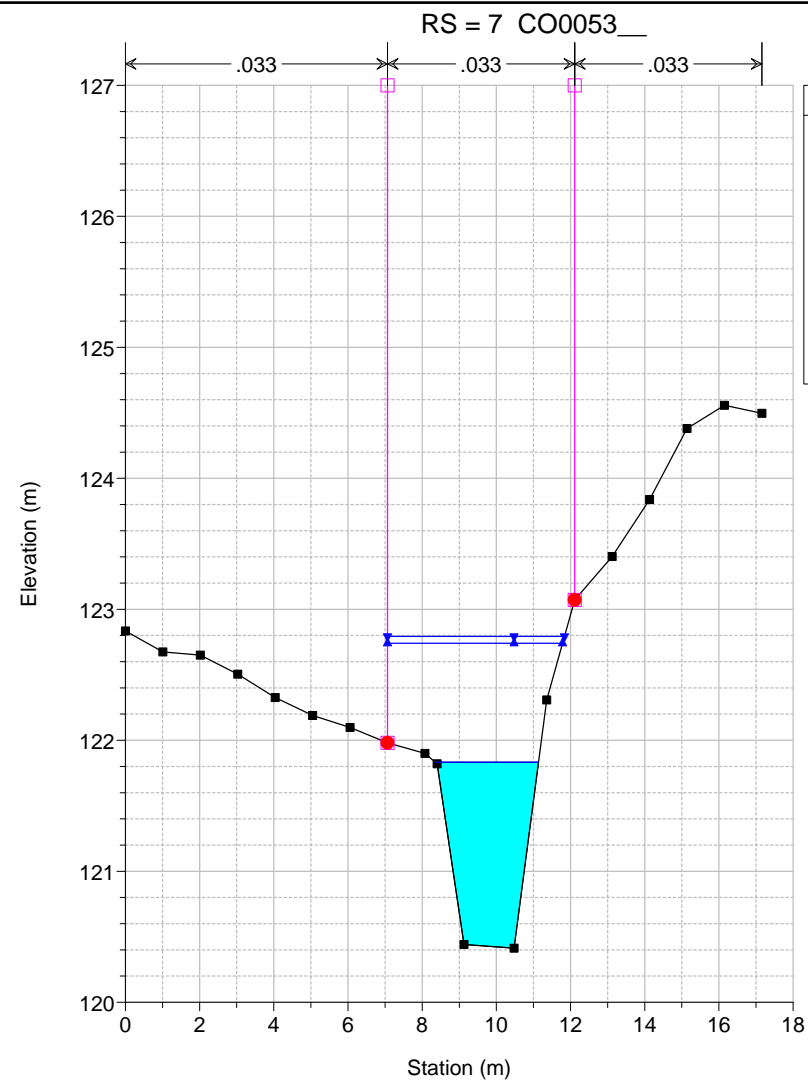
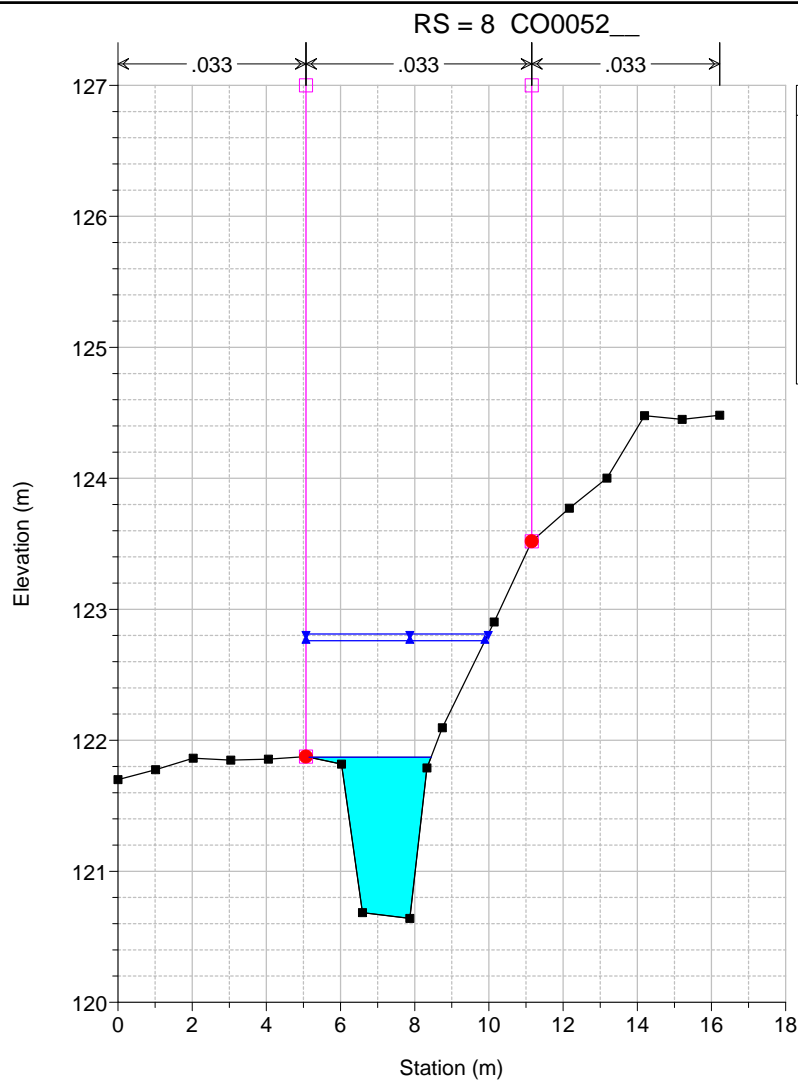

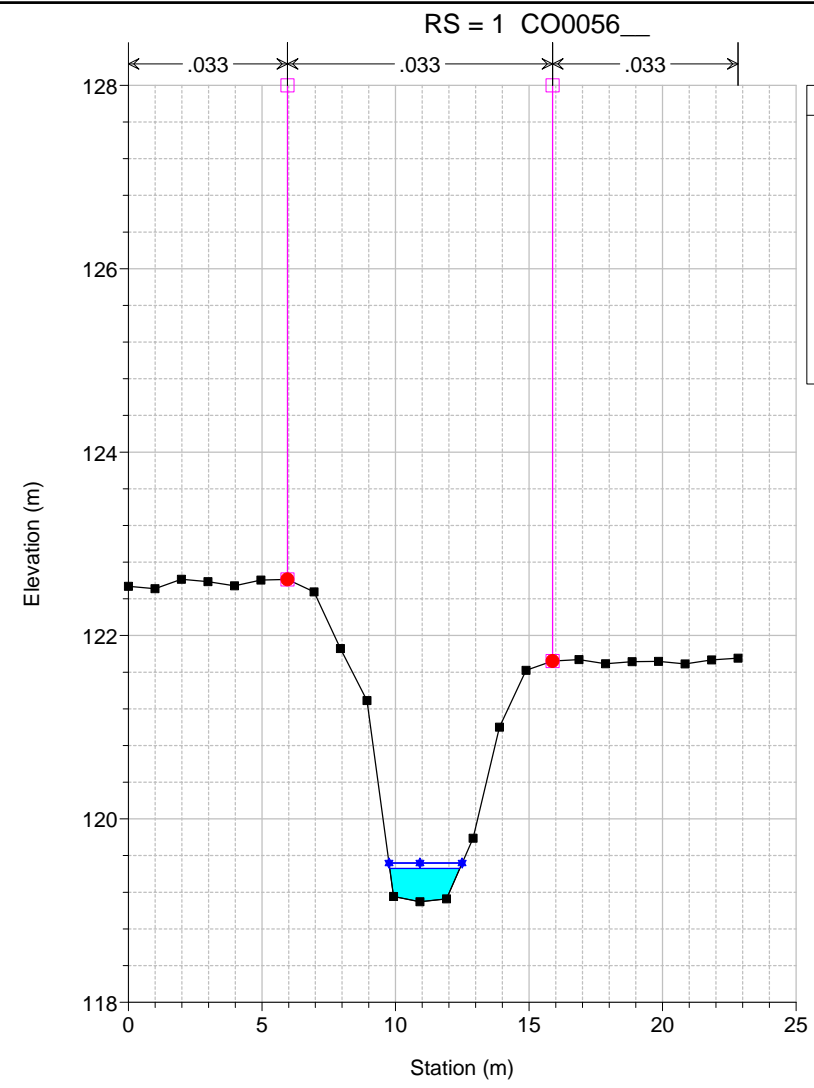
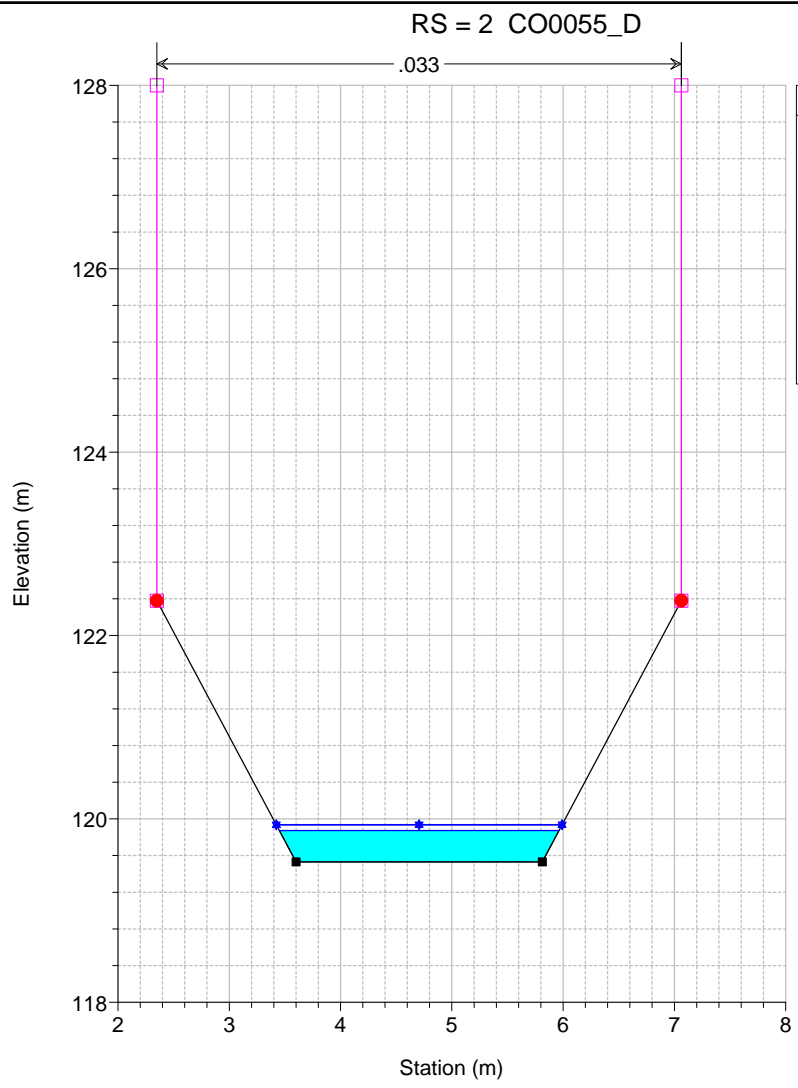

Sezioni fluviali
Diversivo Borro Colmate
Tempo di ritorno: 30, 200 e 500 anni

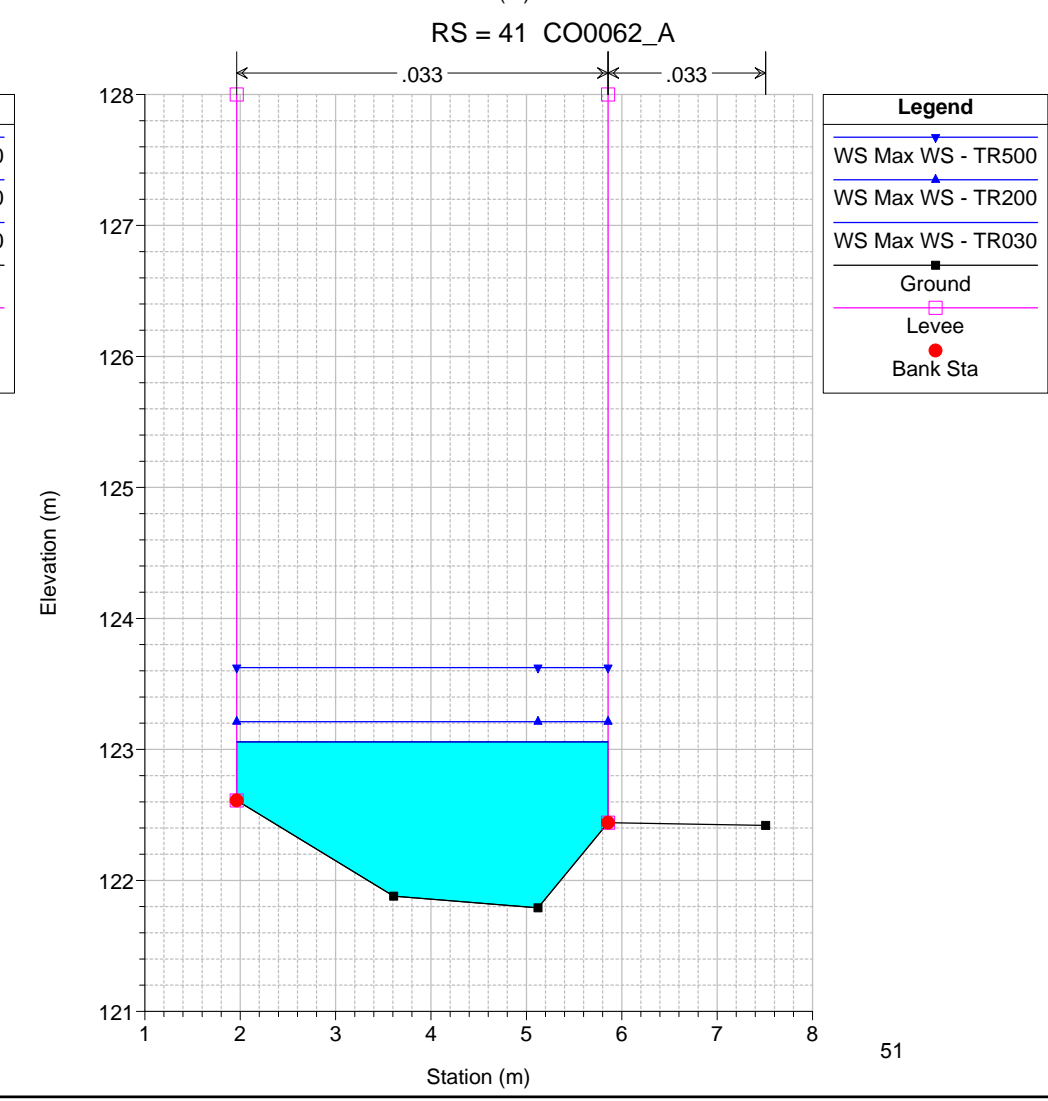
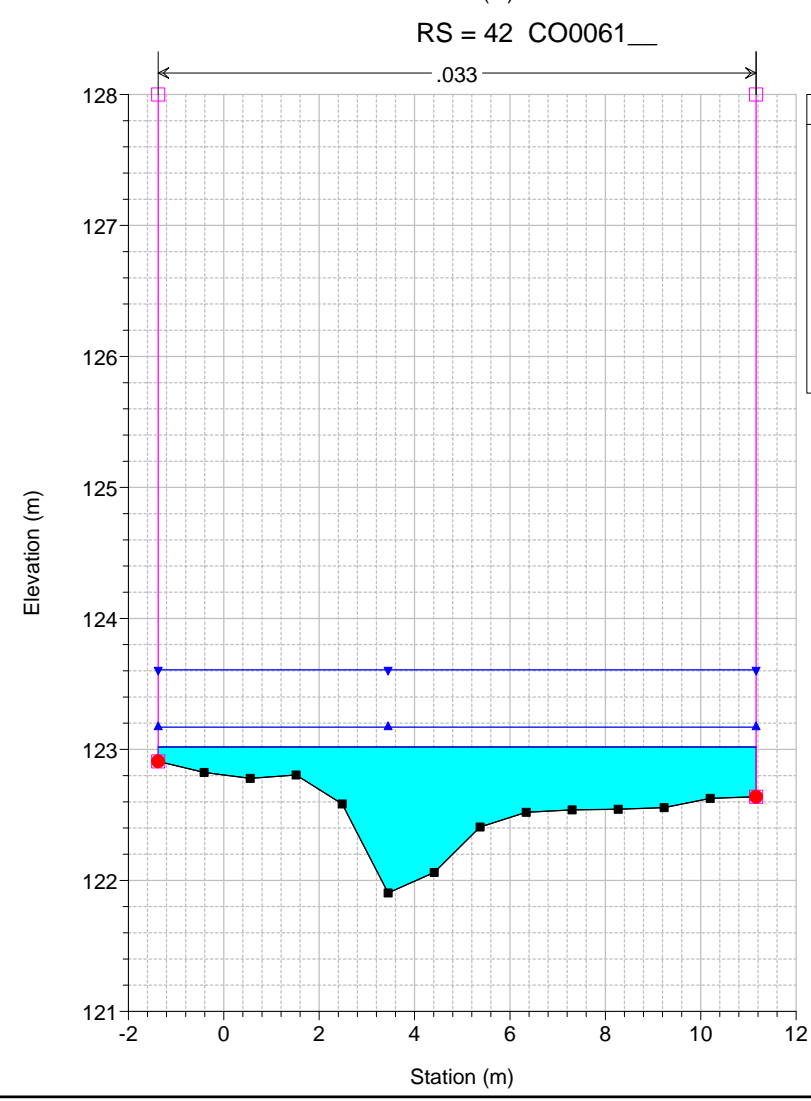
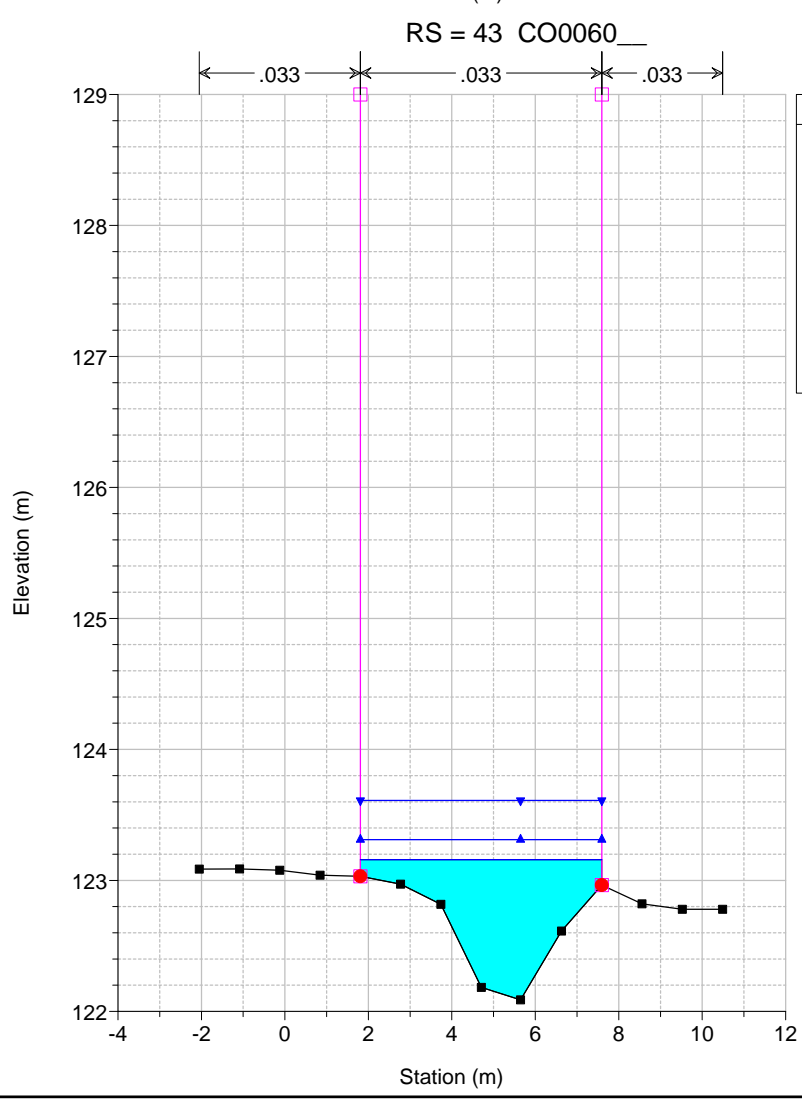
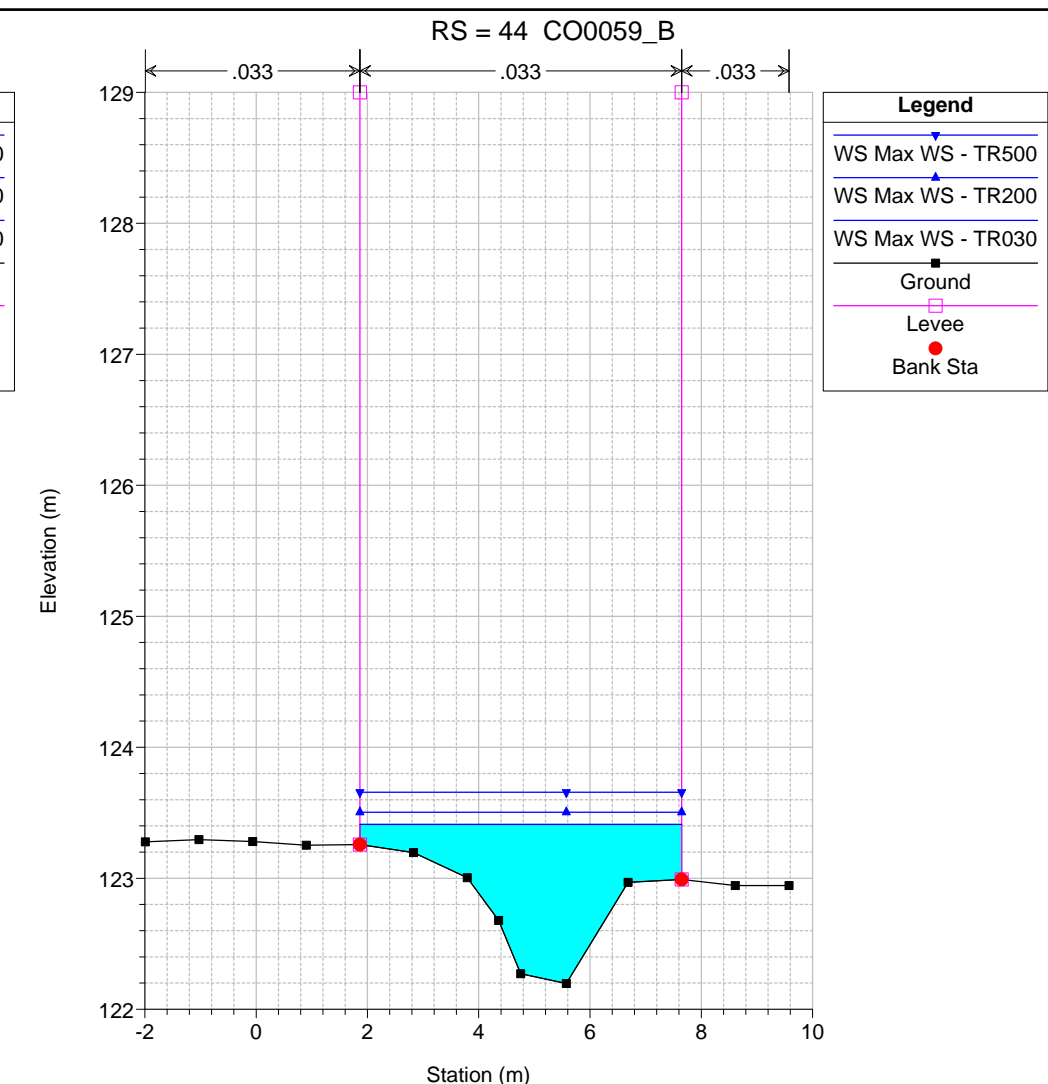
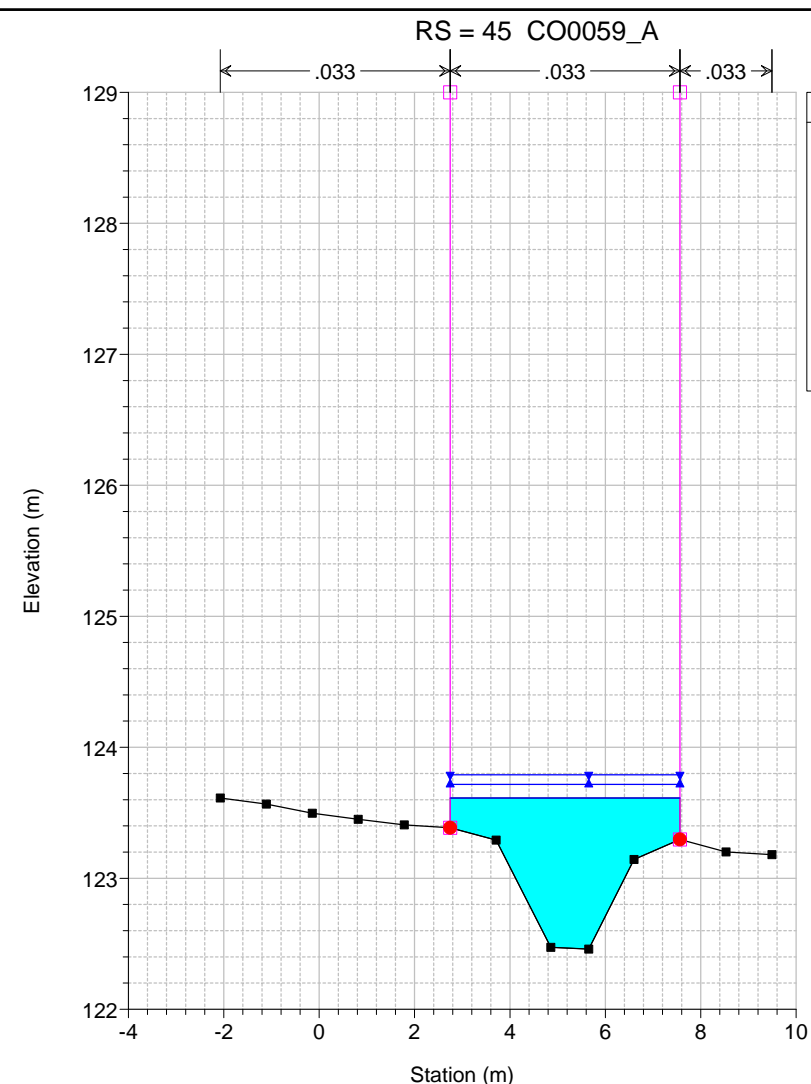
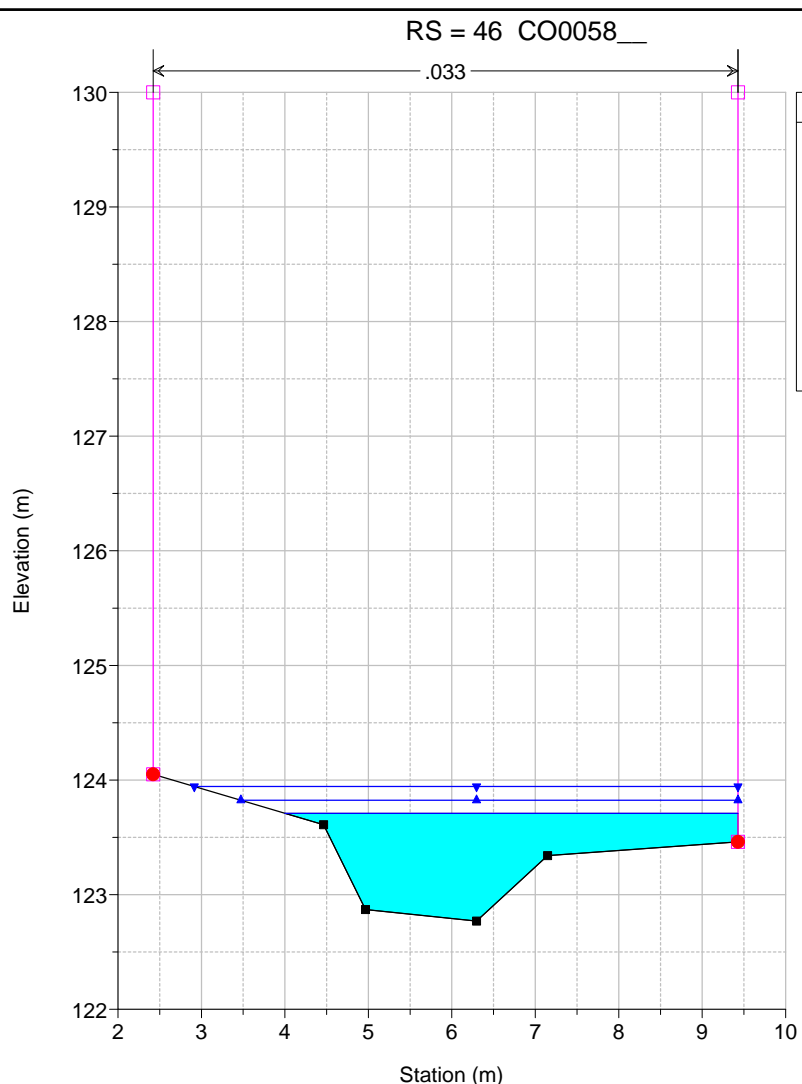

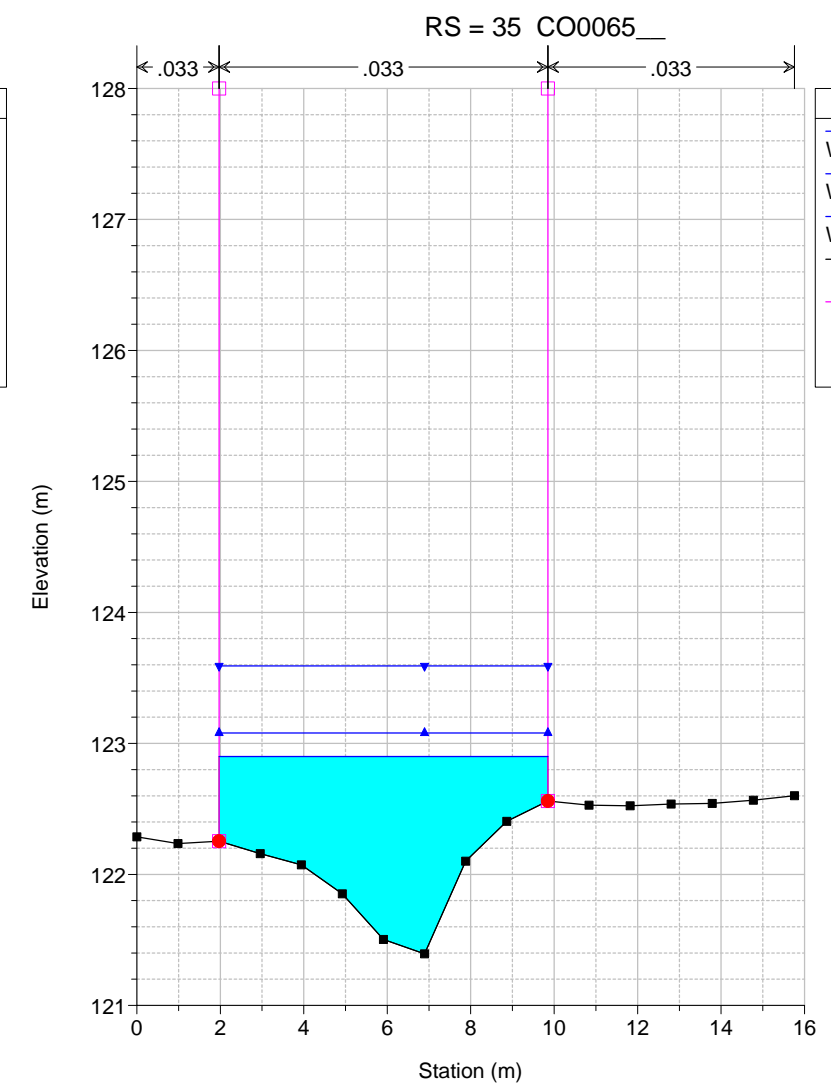
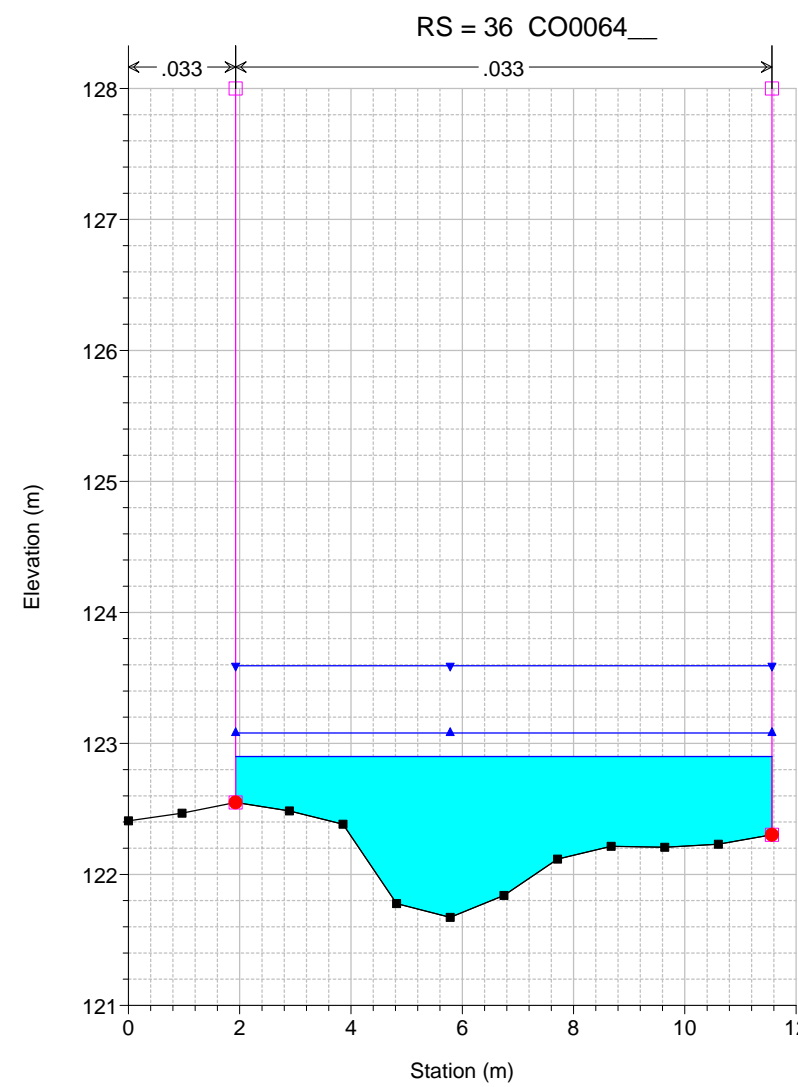
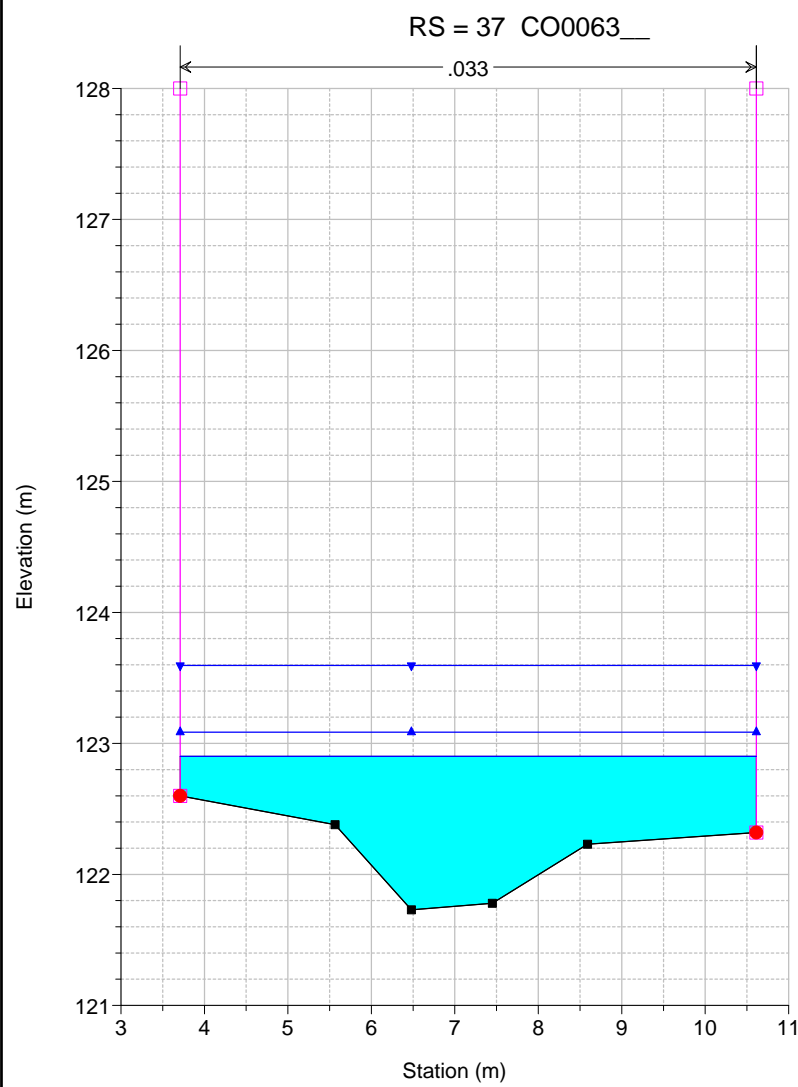
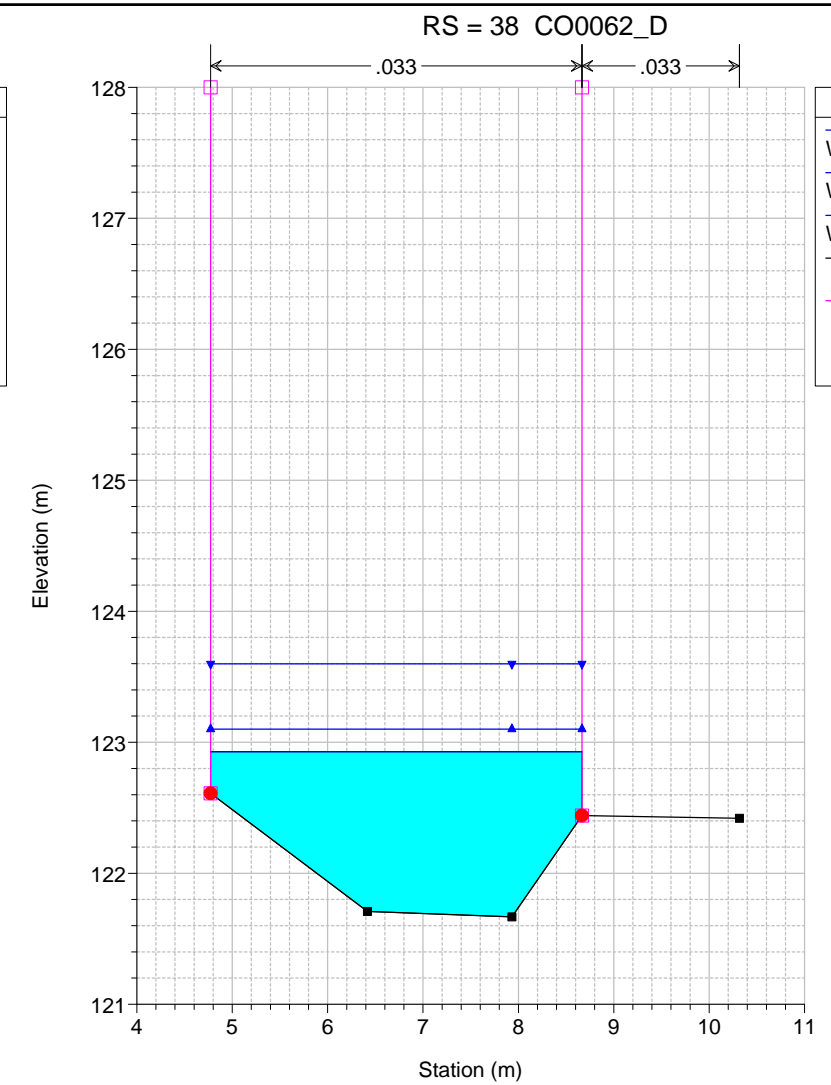
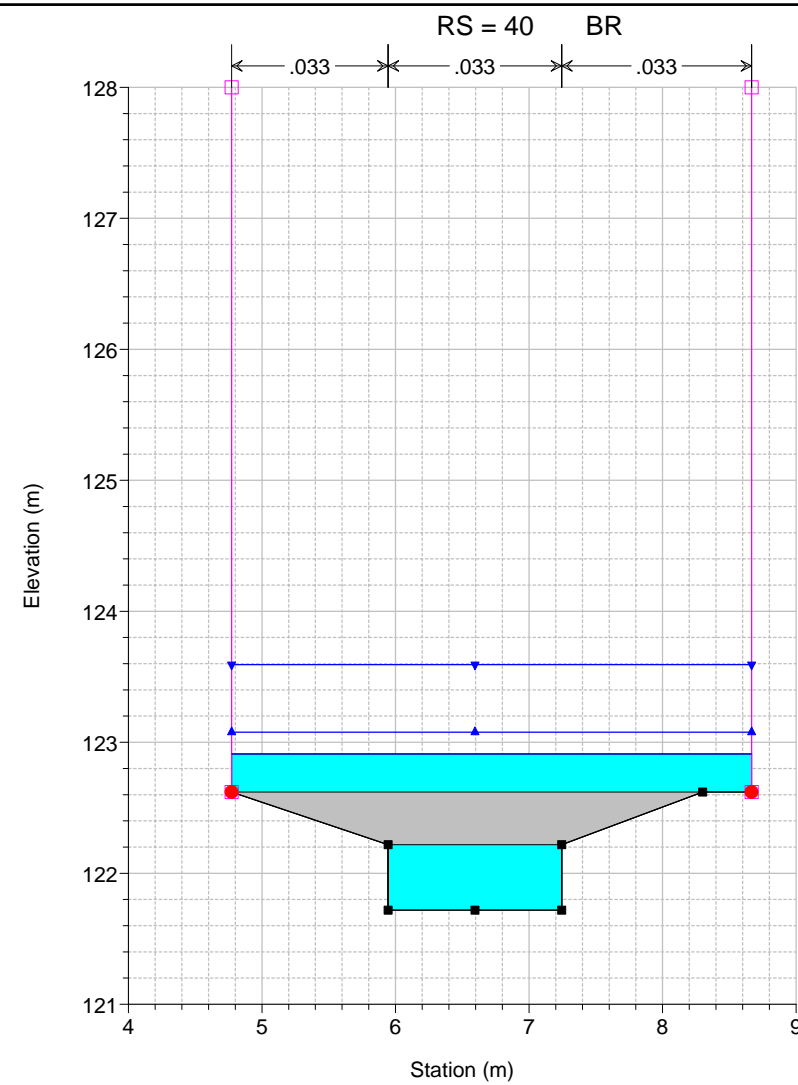
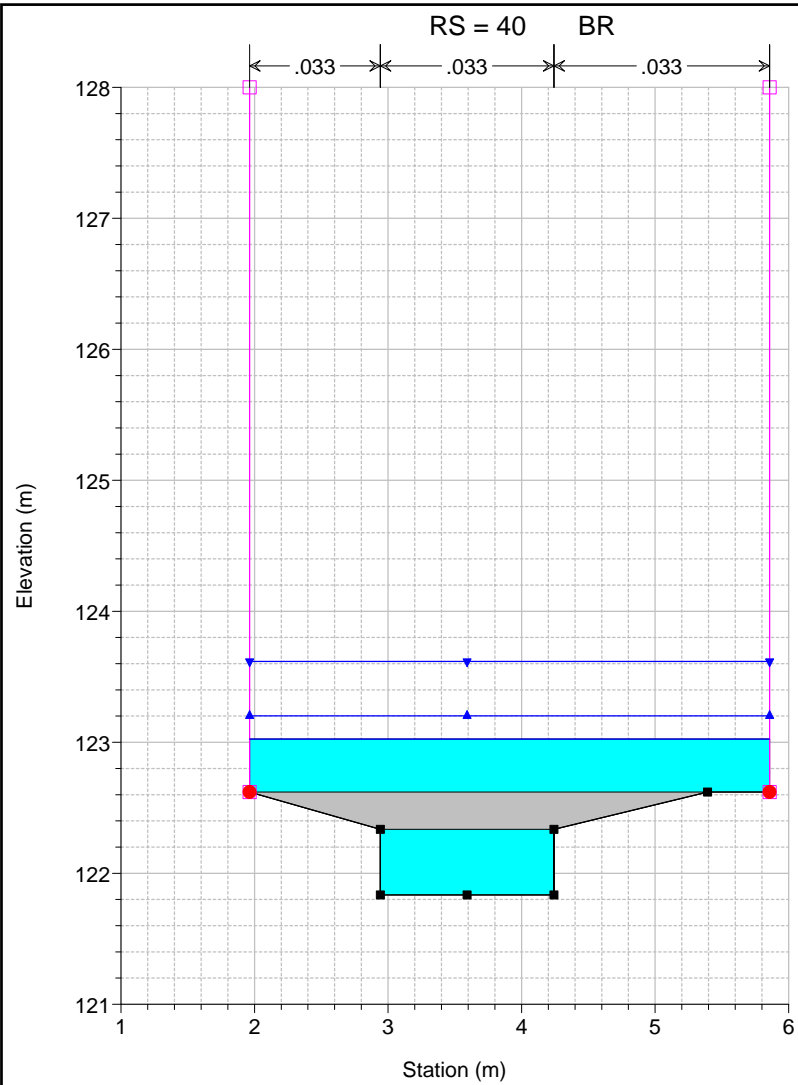

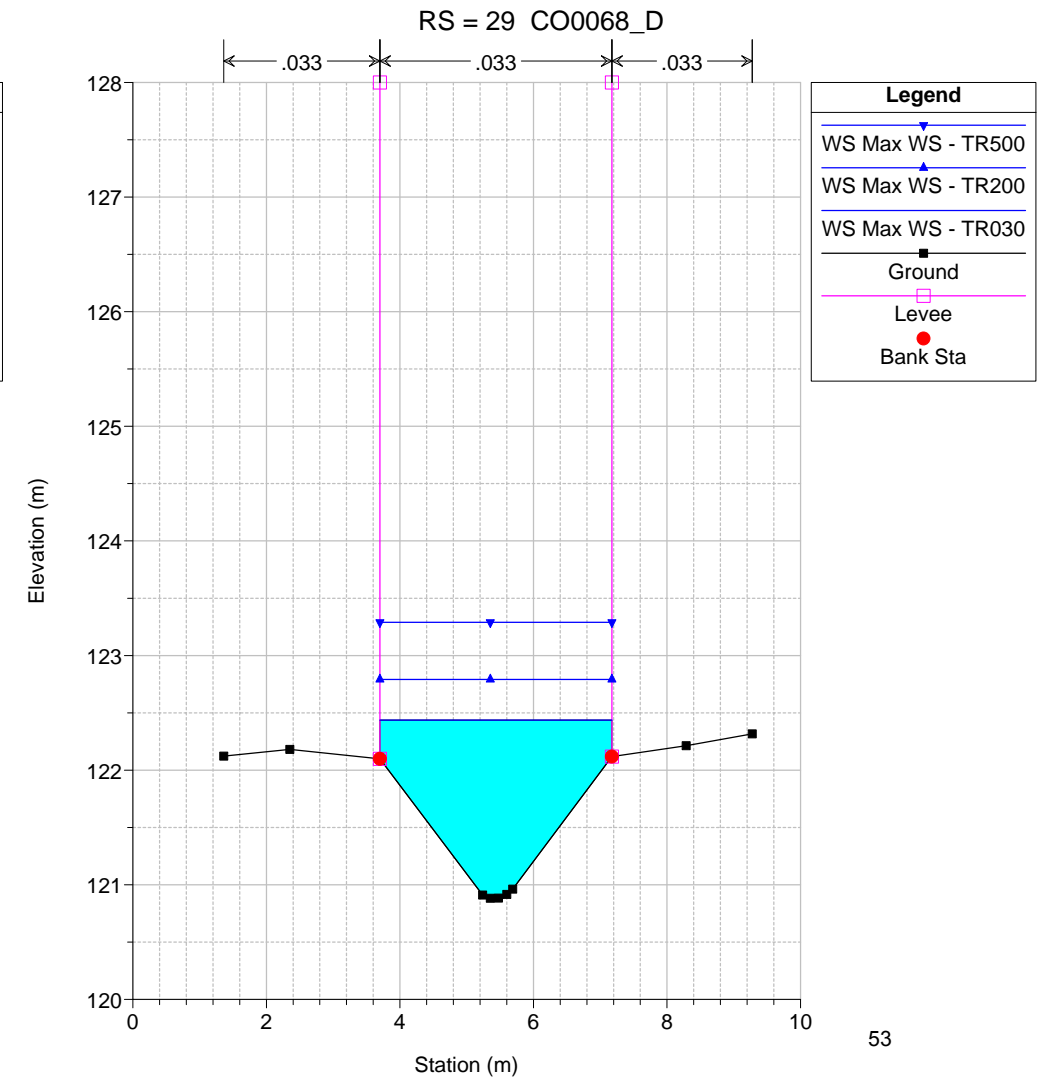
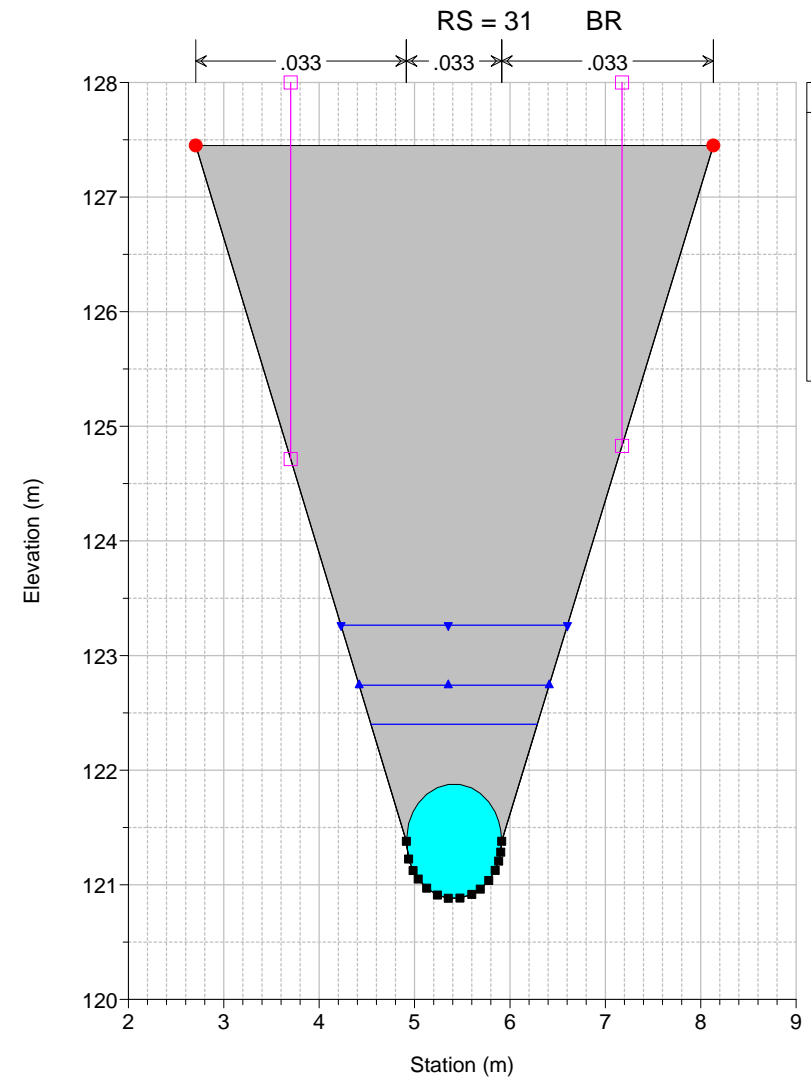
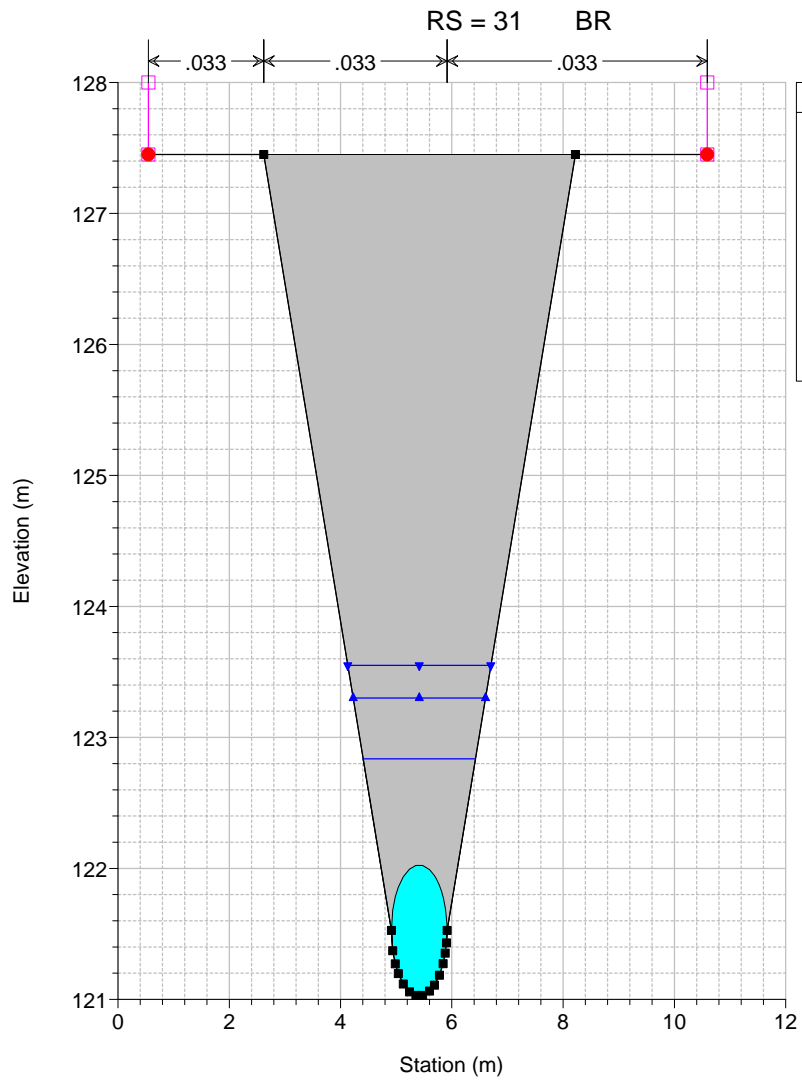
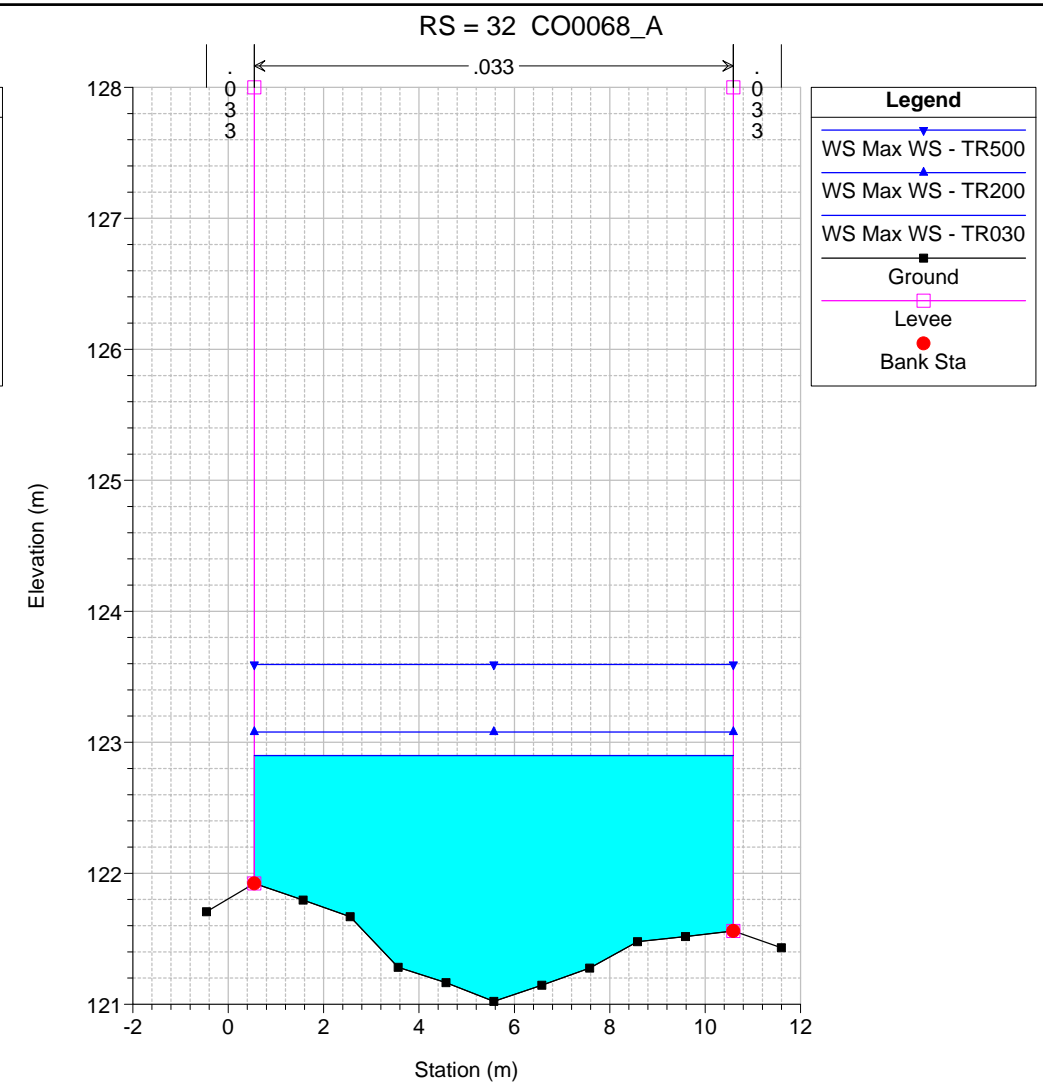
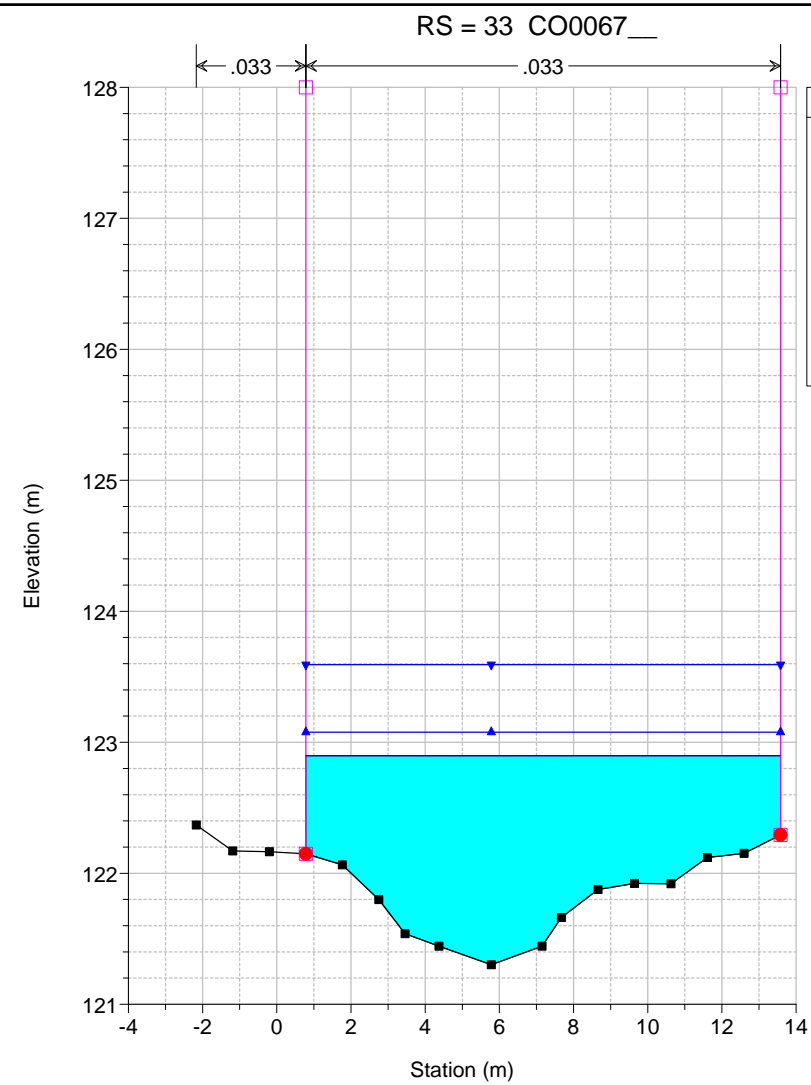
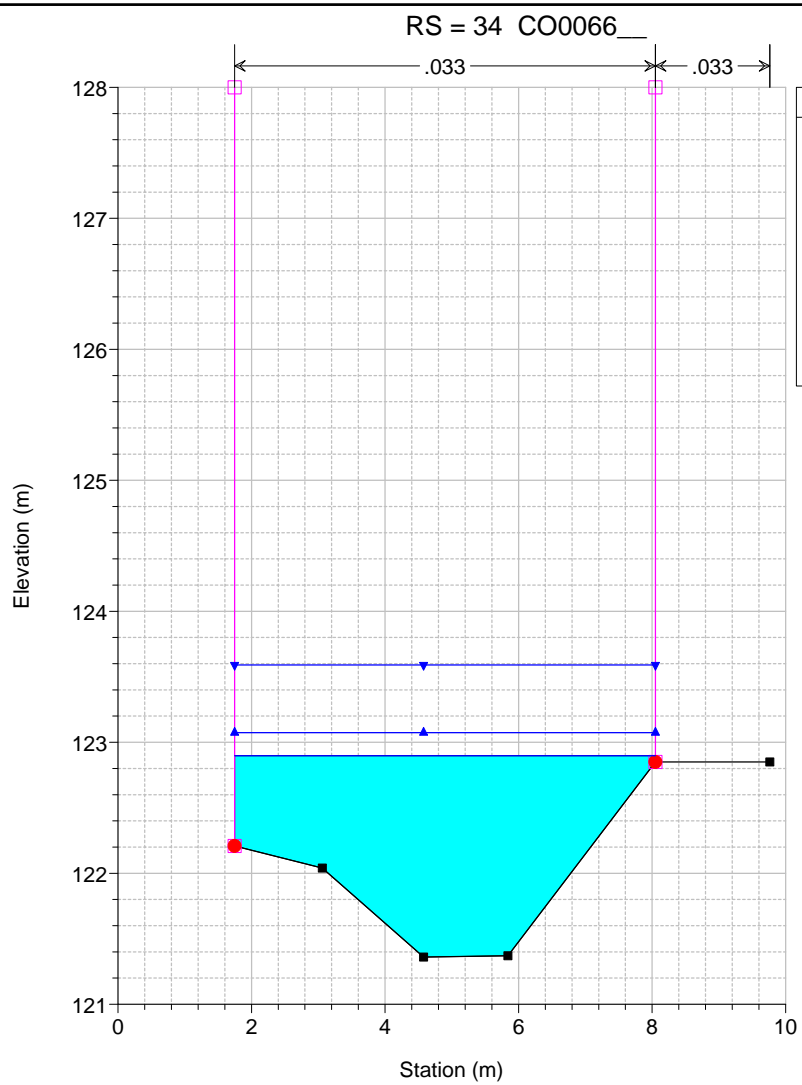

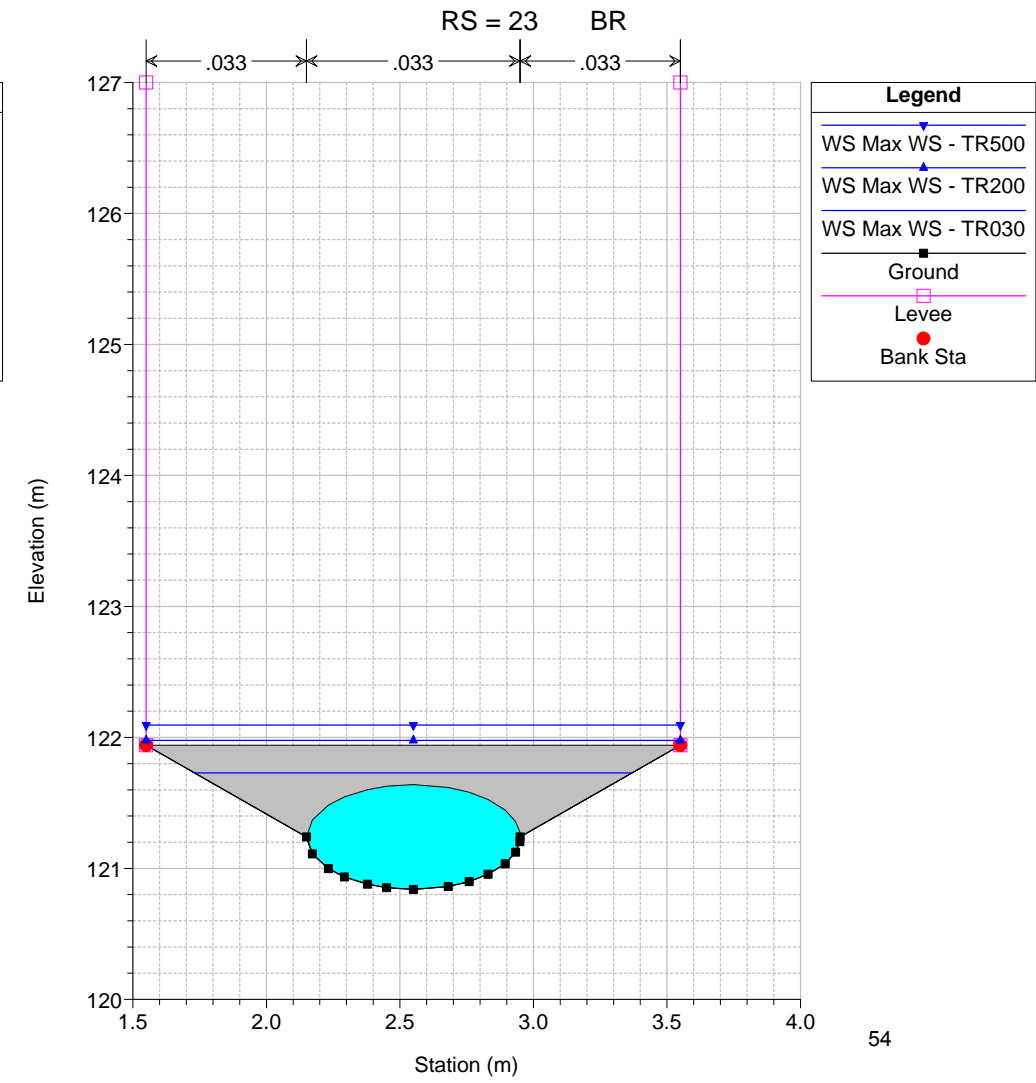
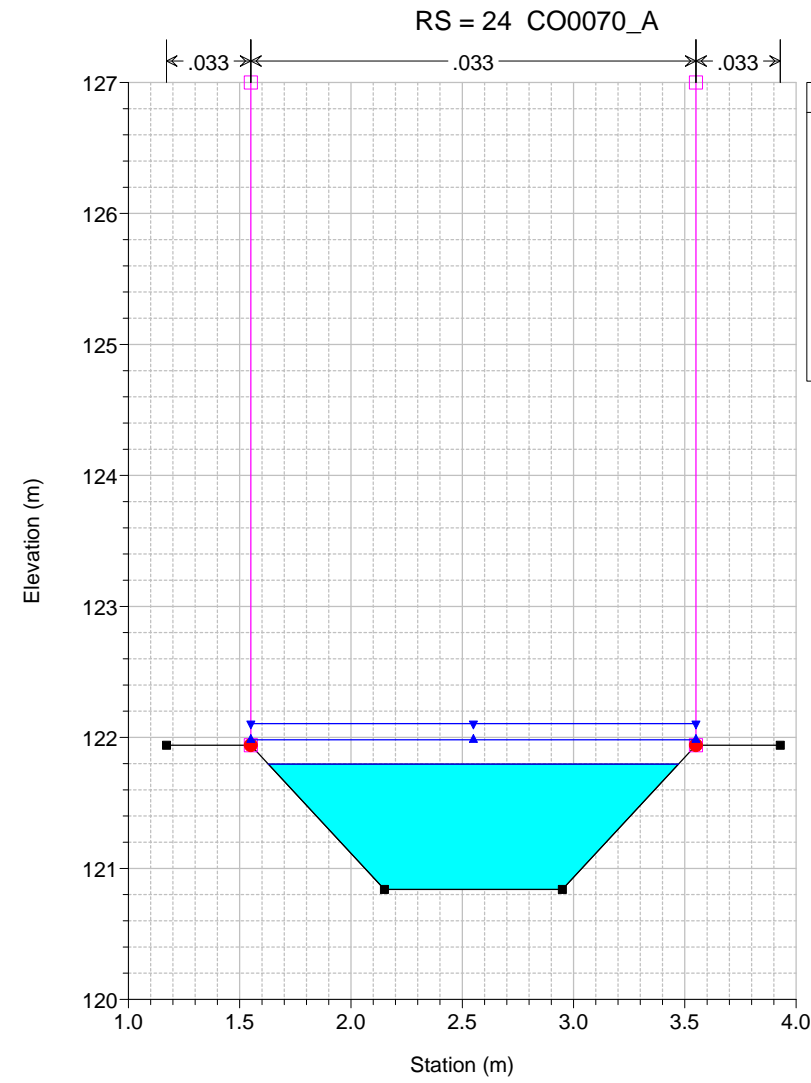
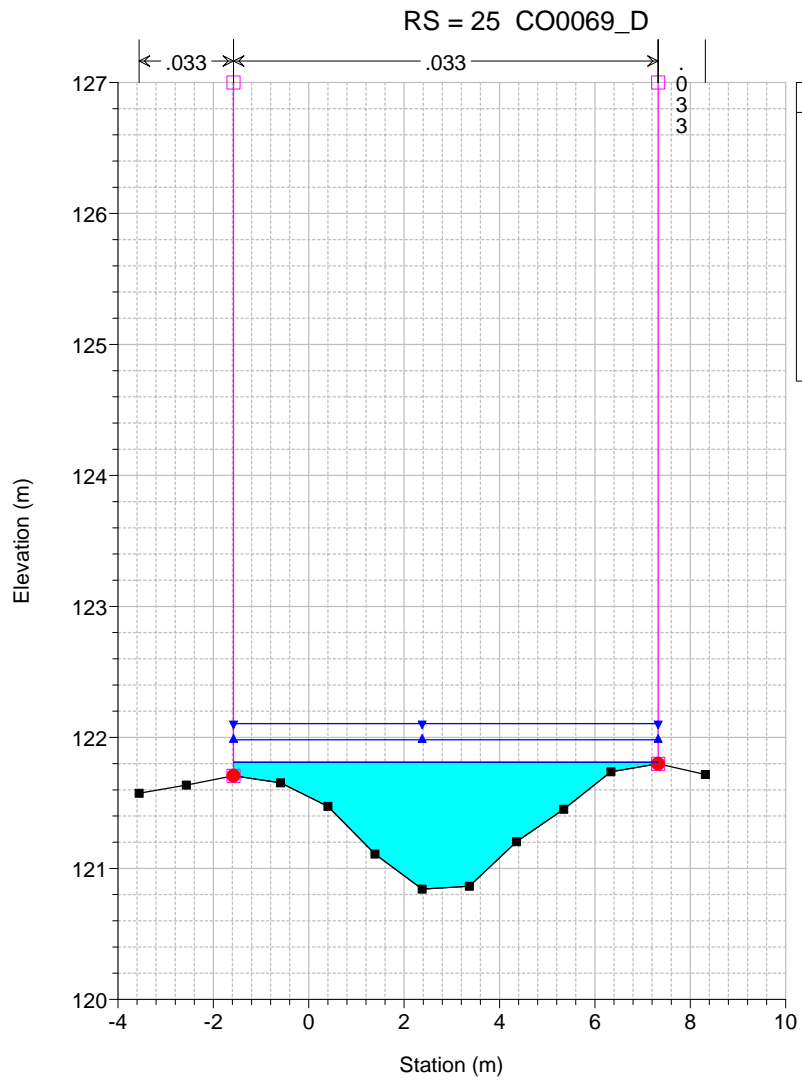
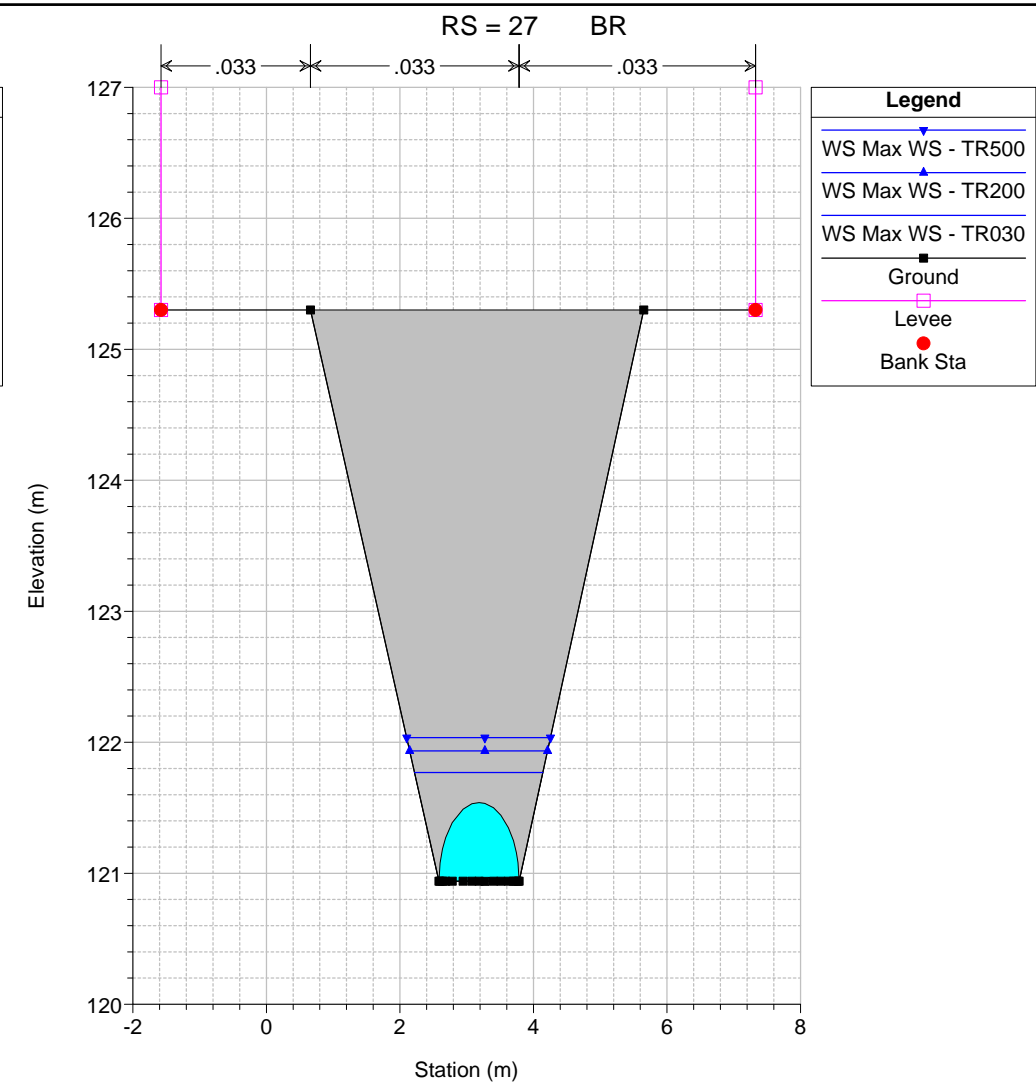
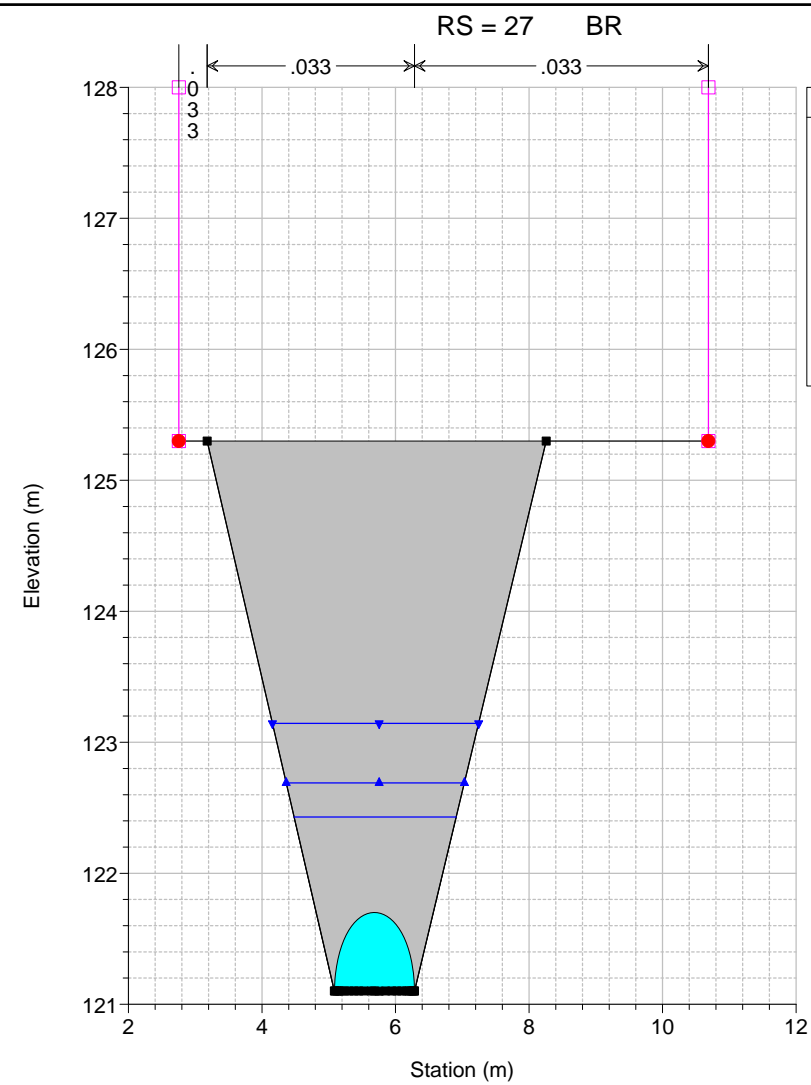
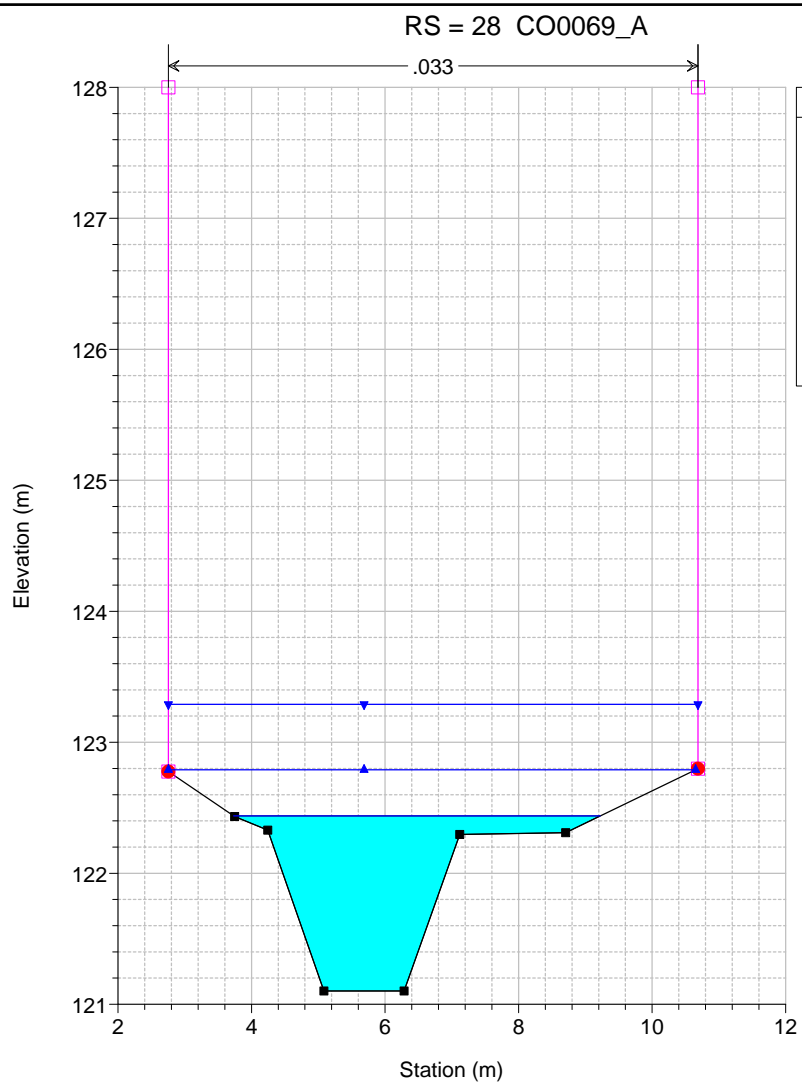

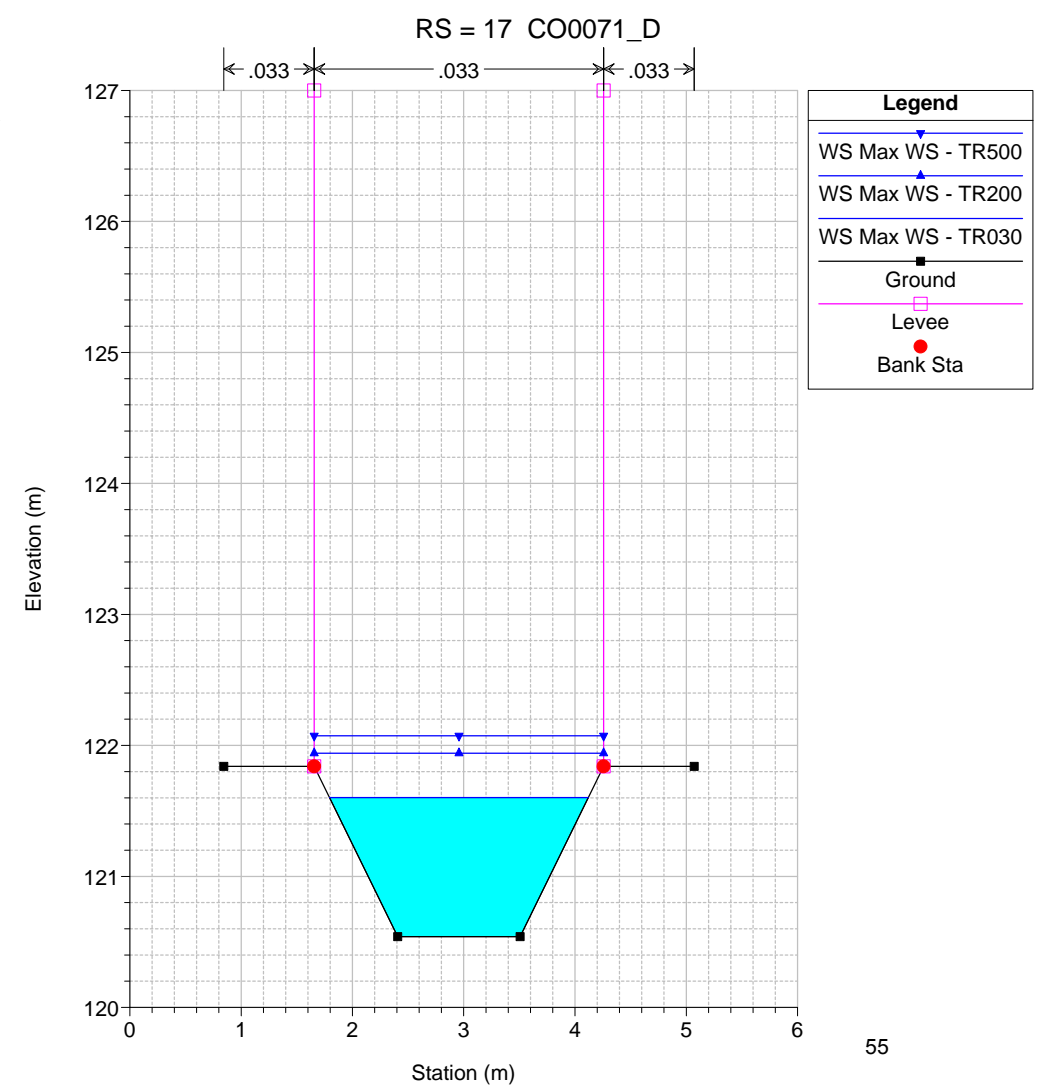
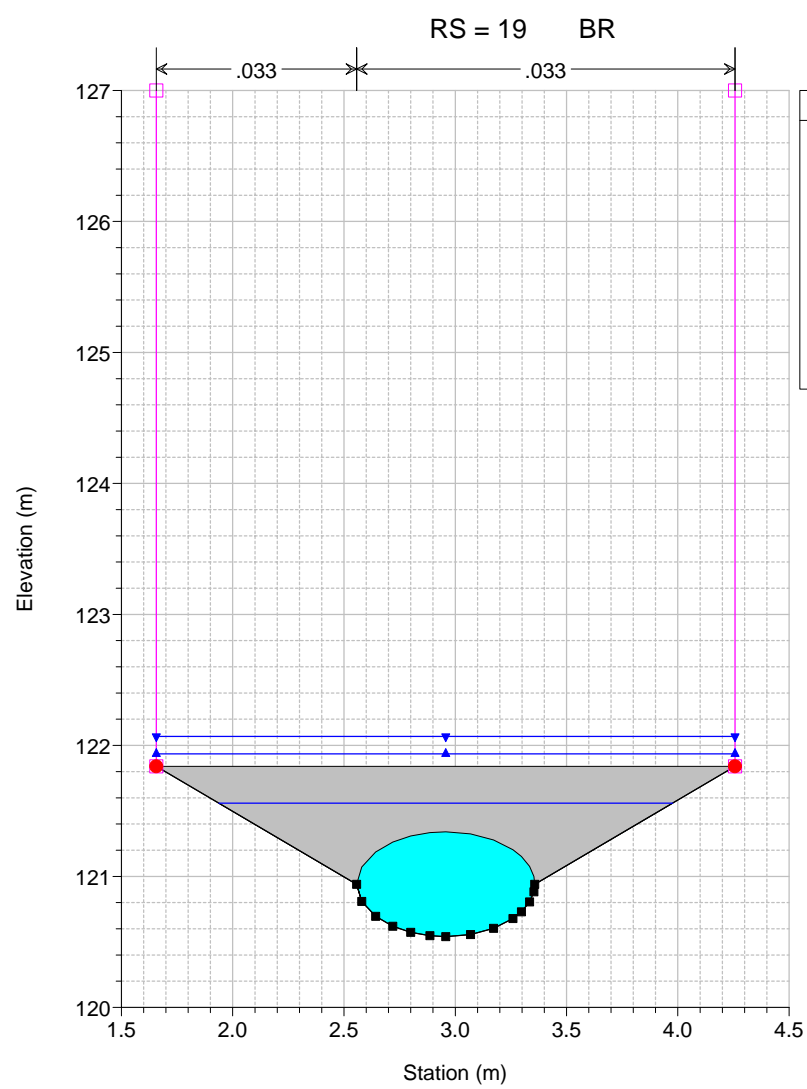
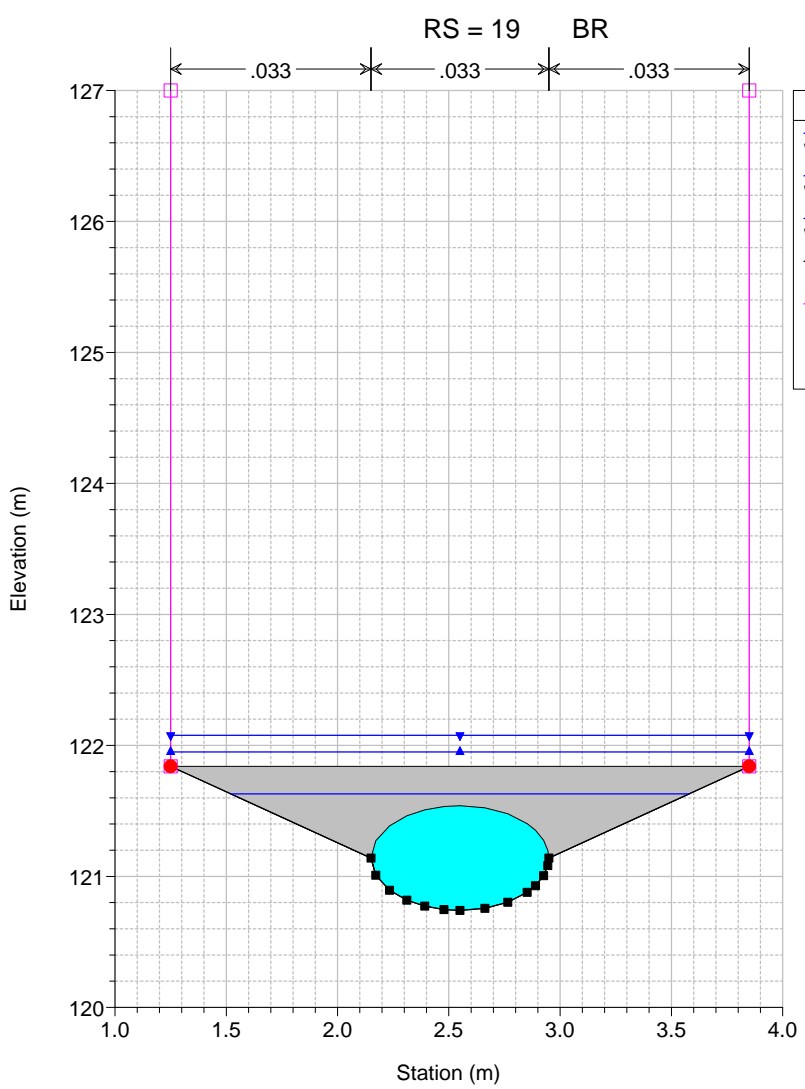
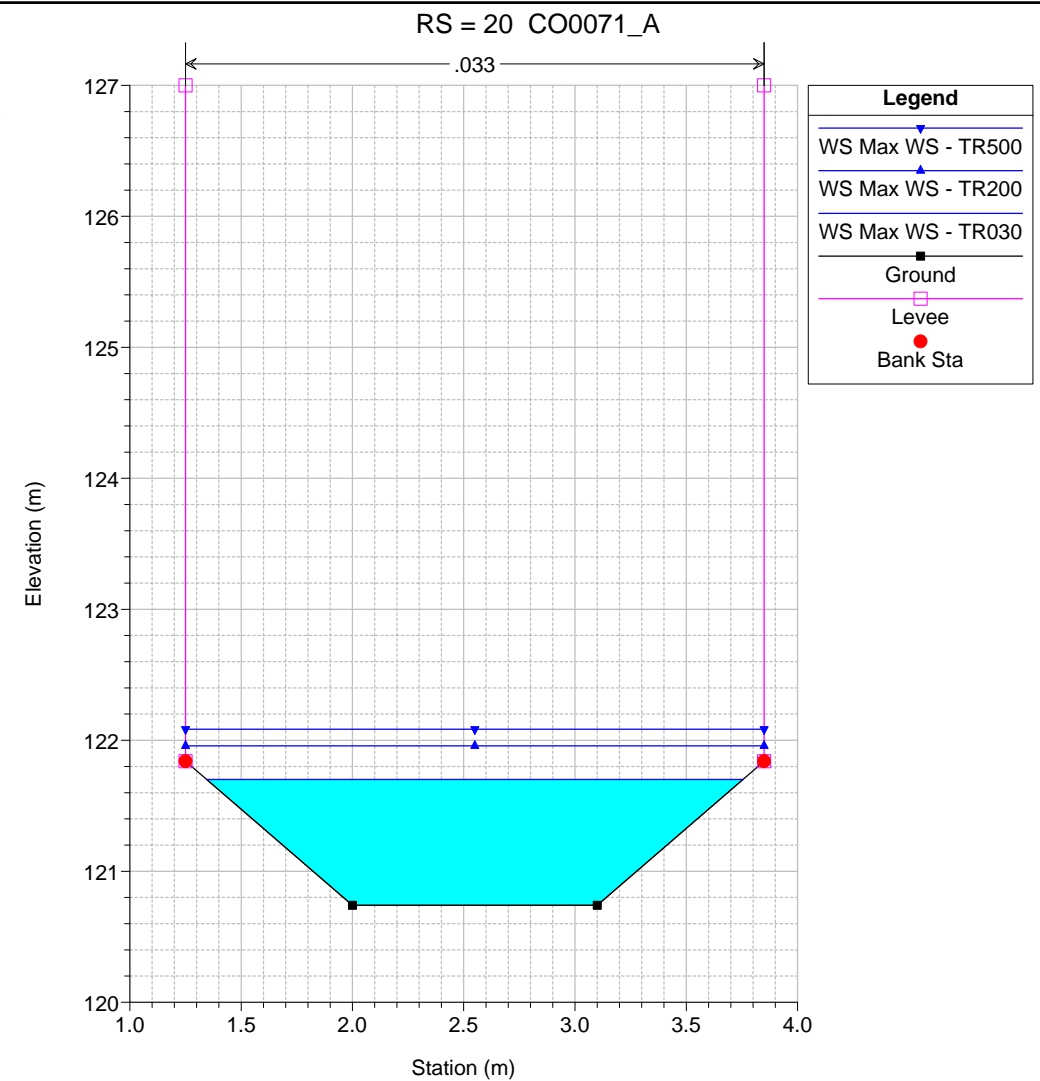
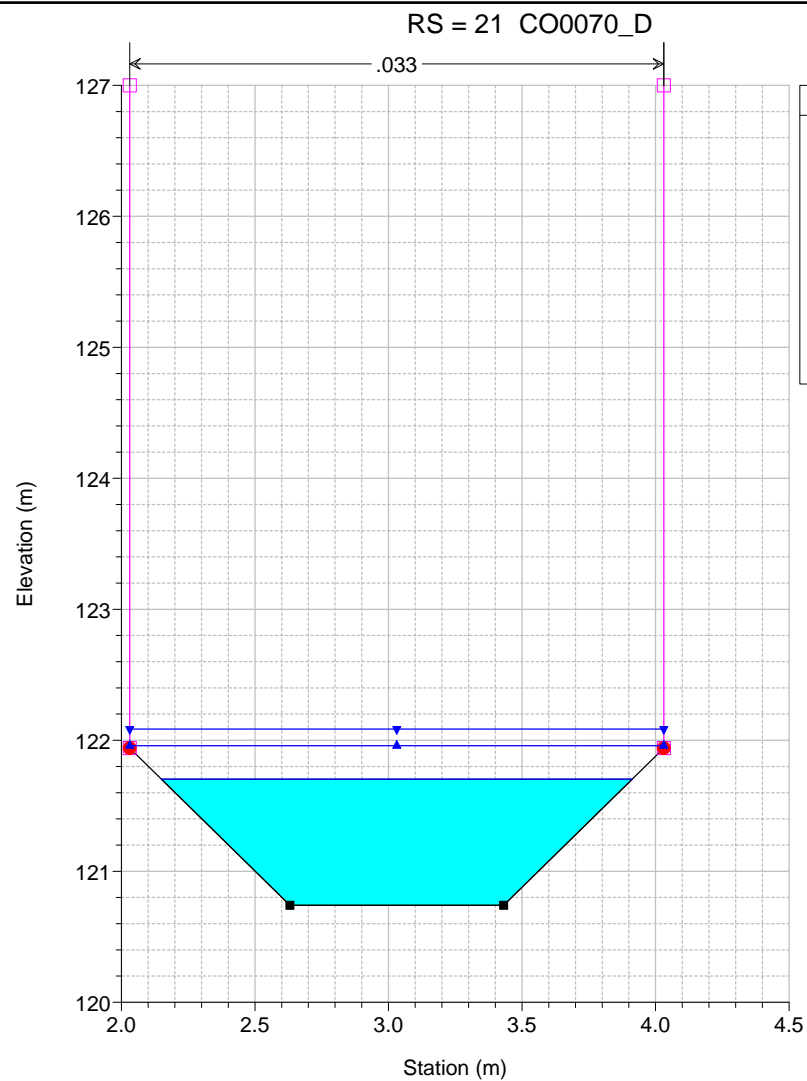
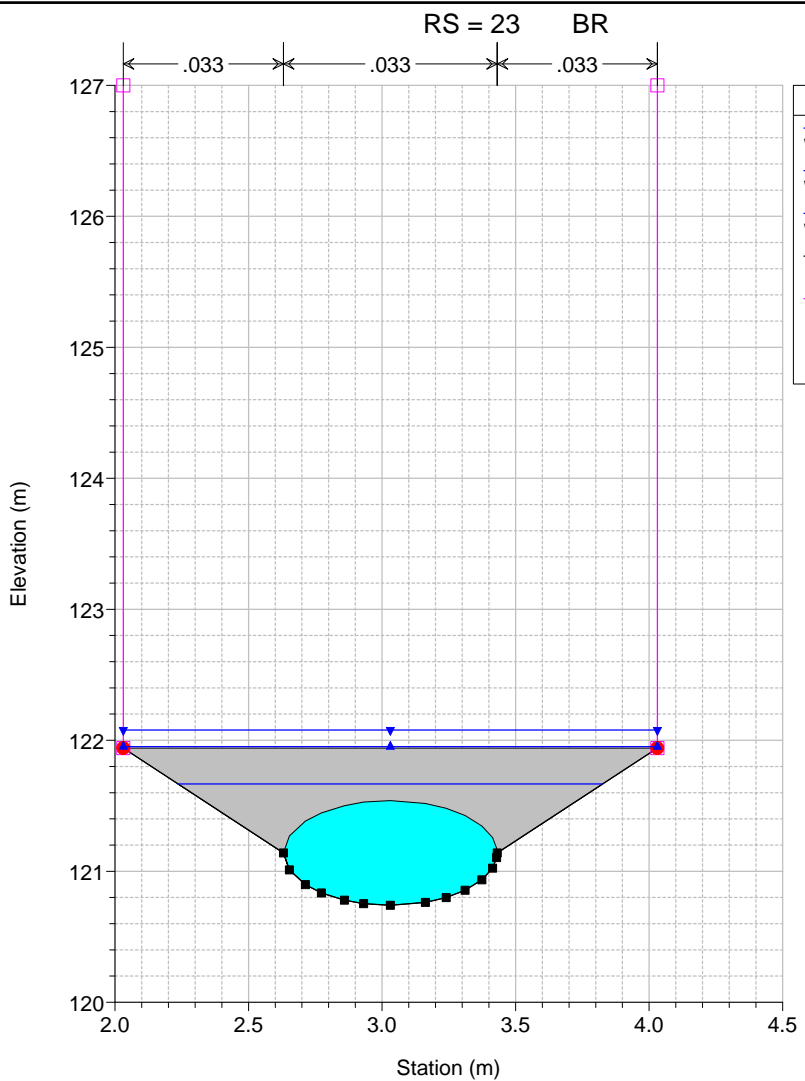

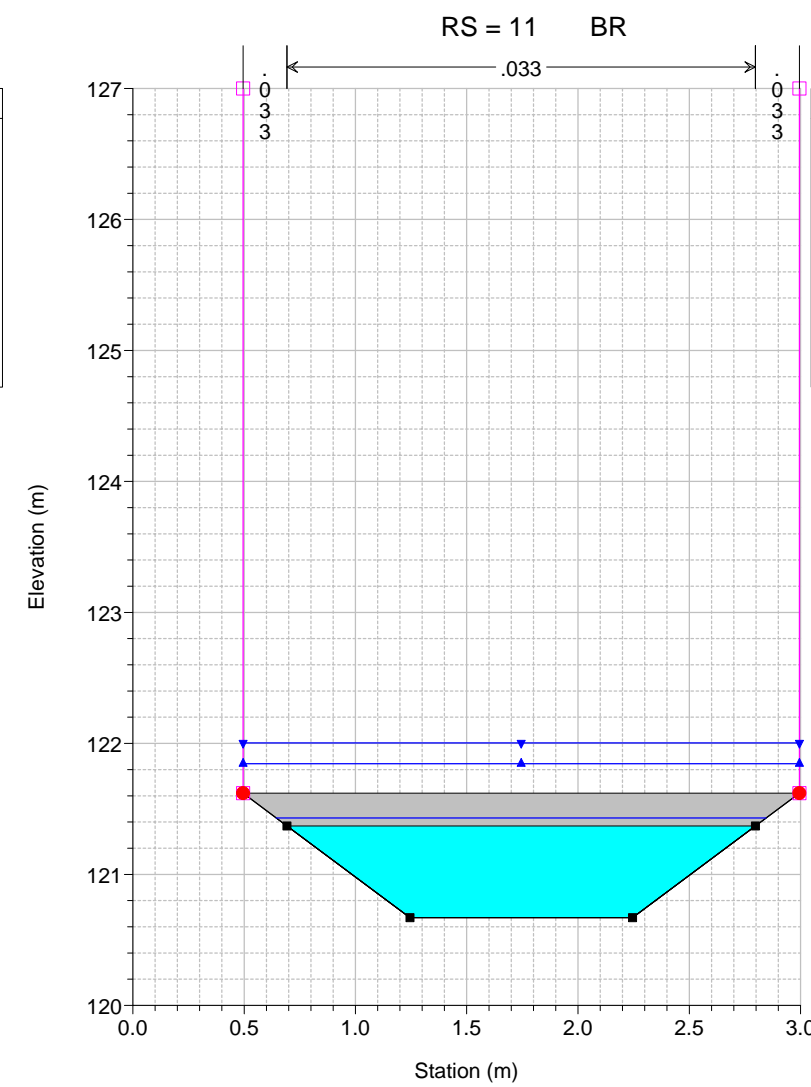
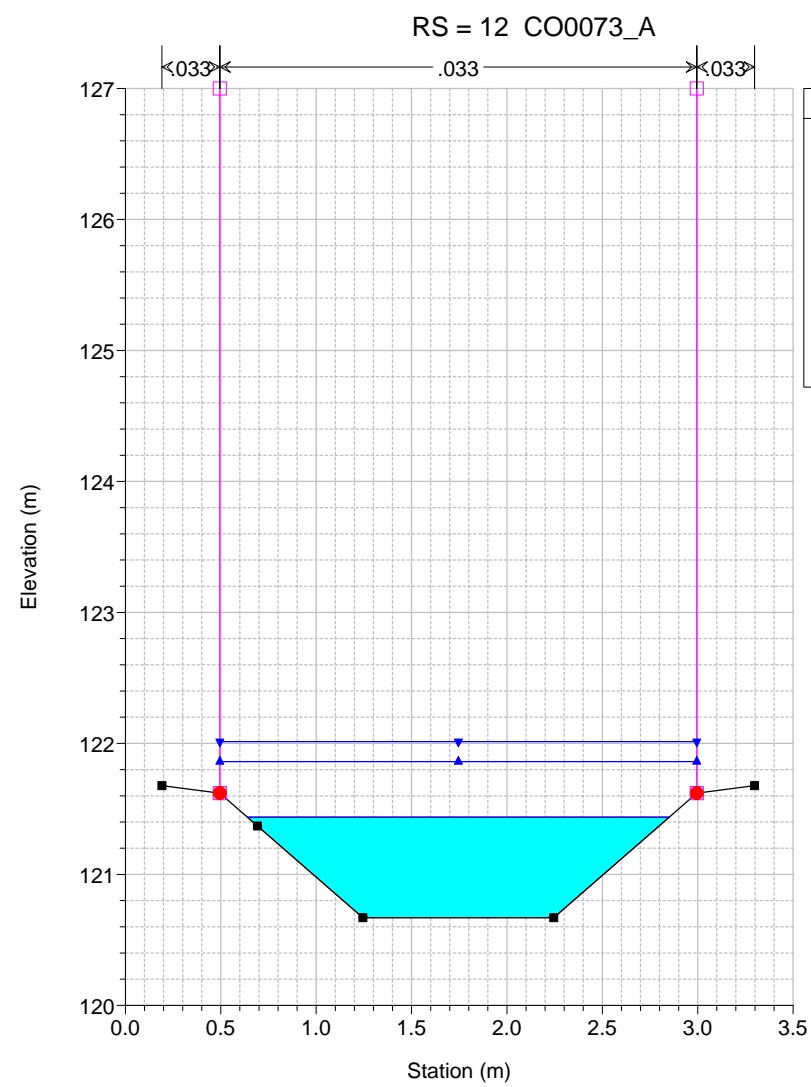
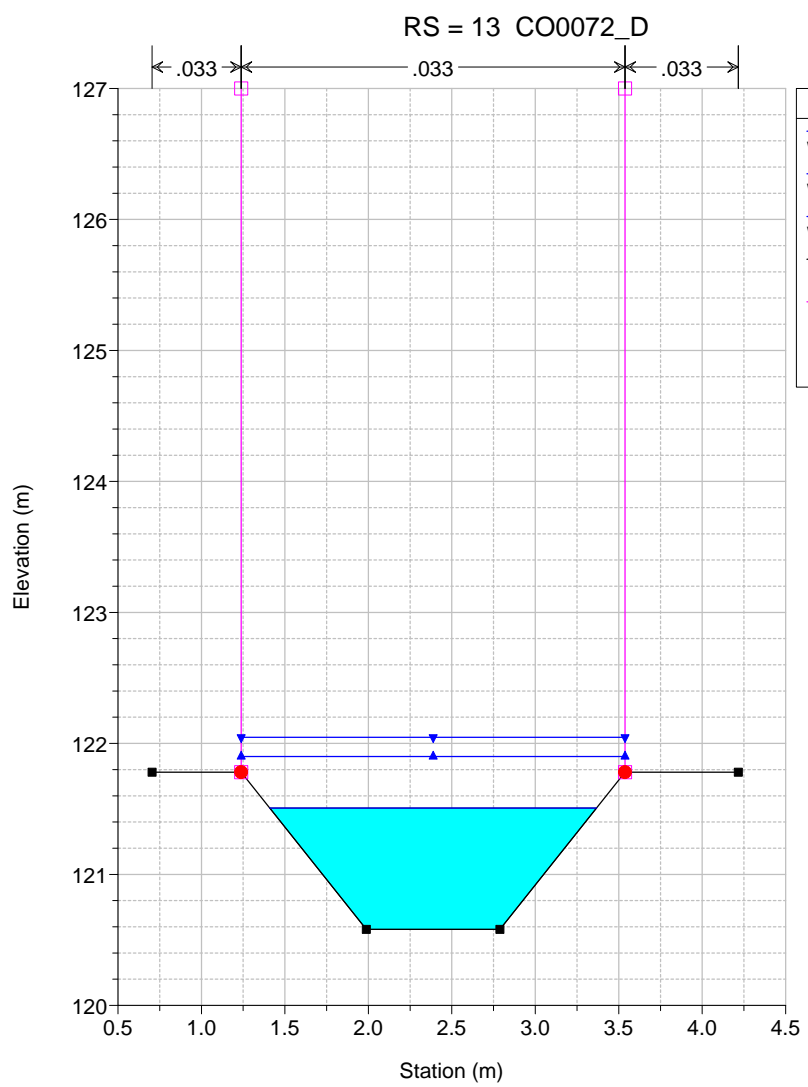
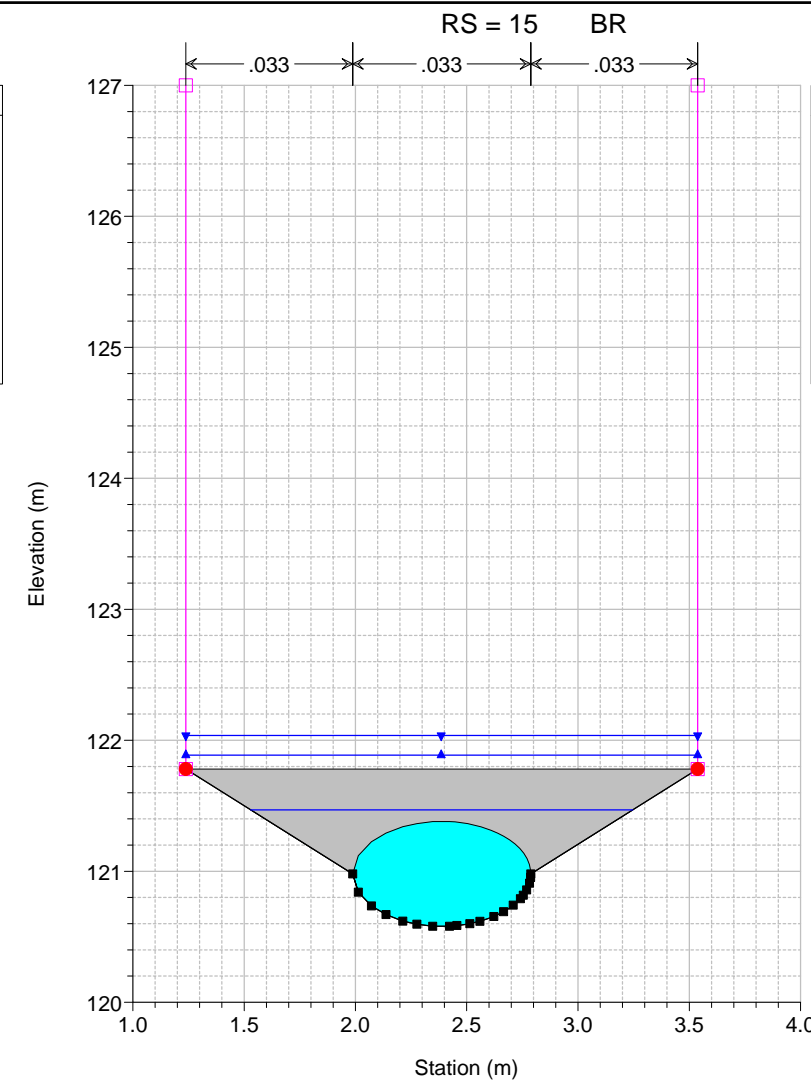
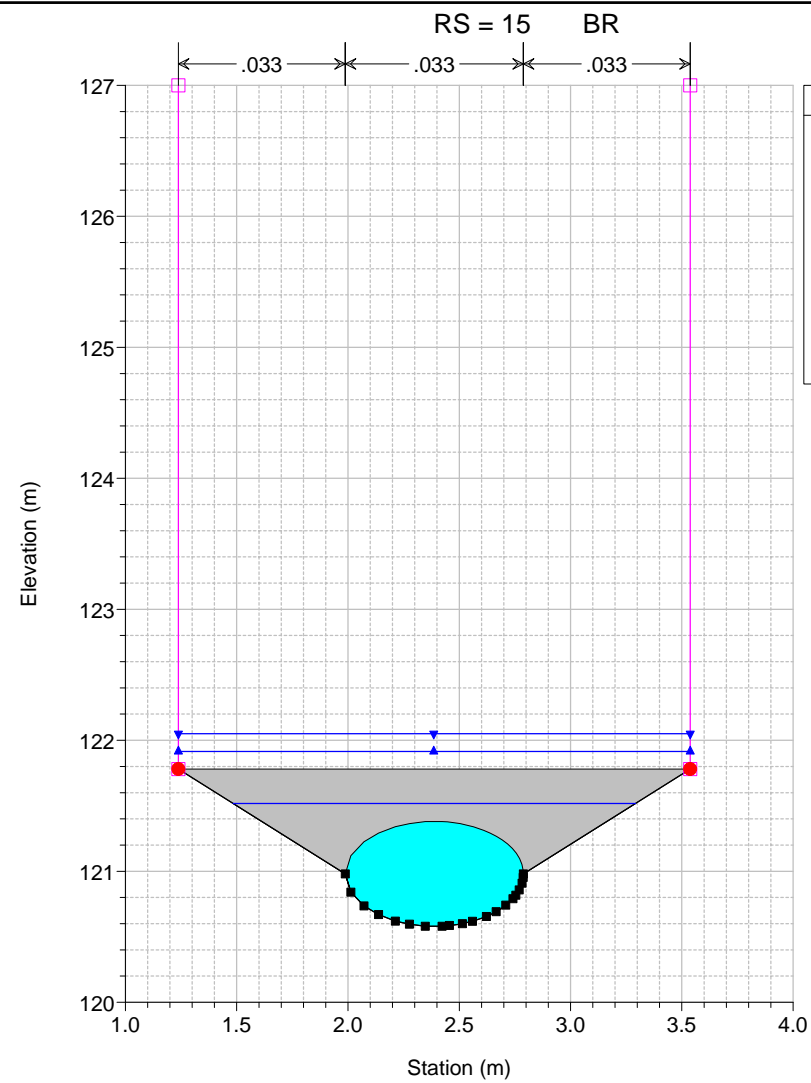
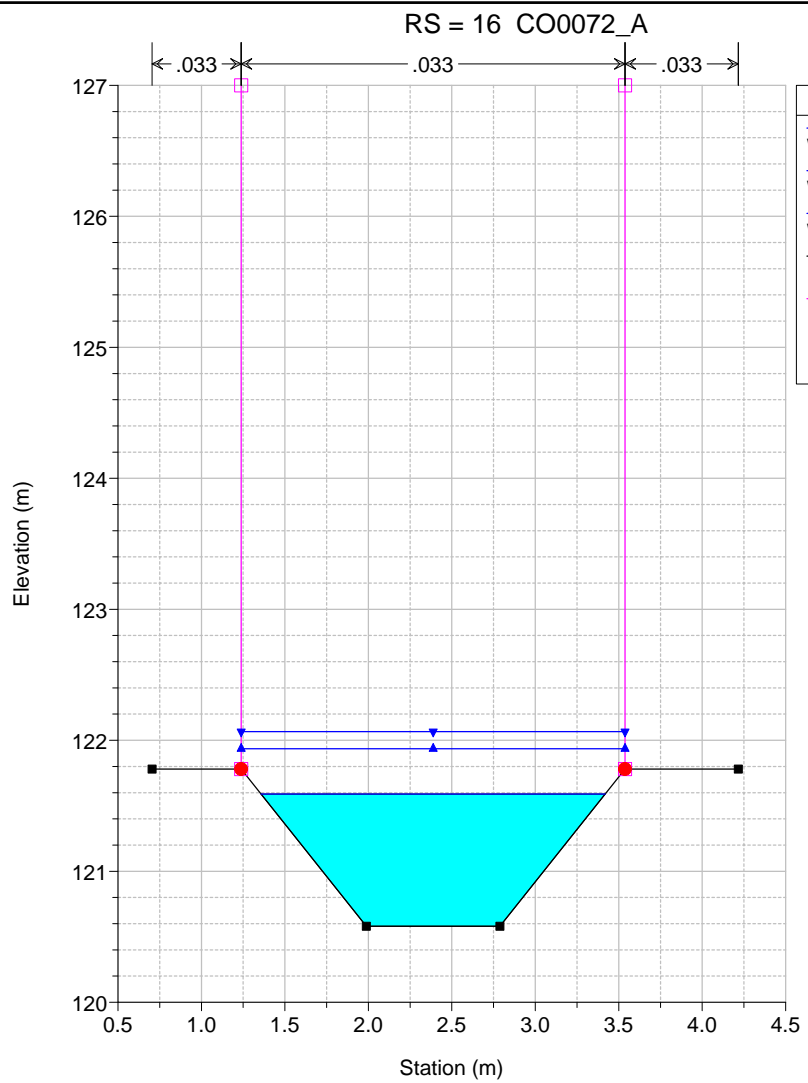

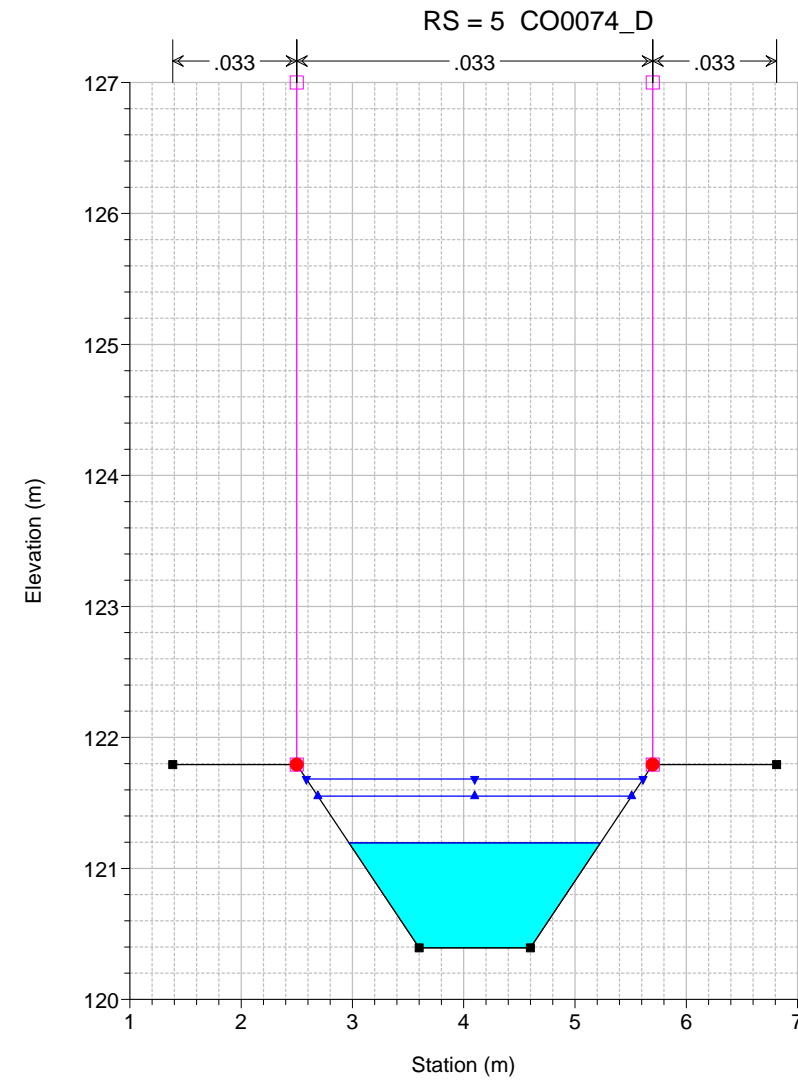
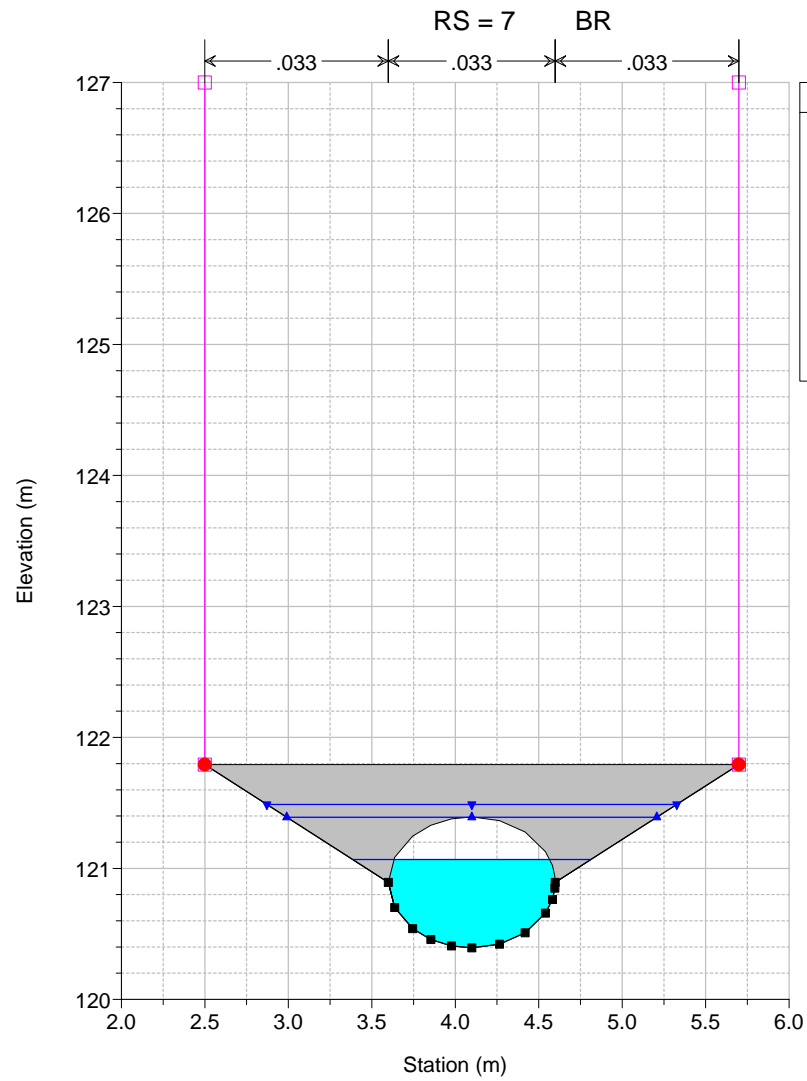
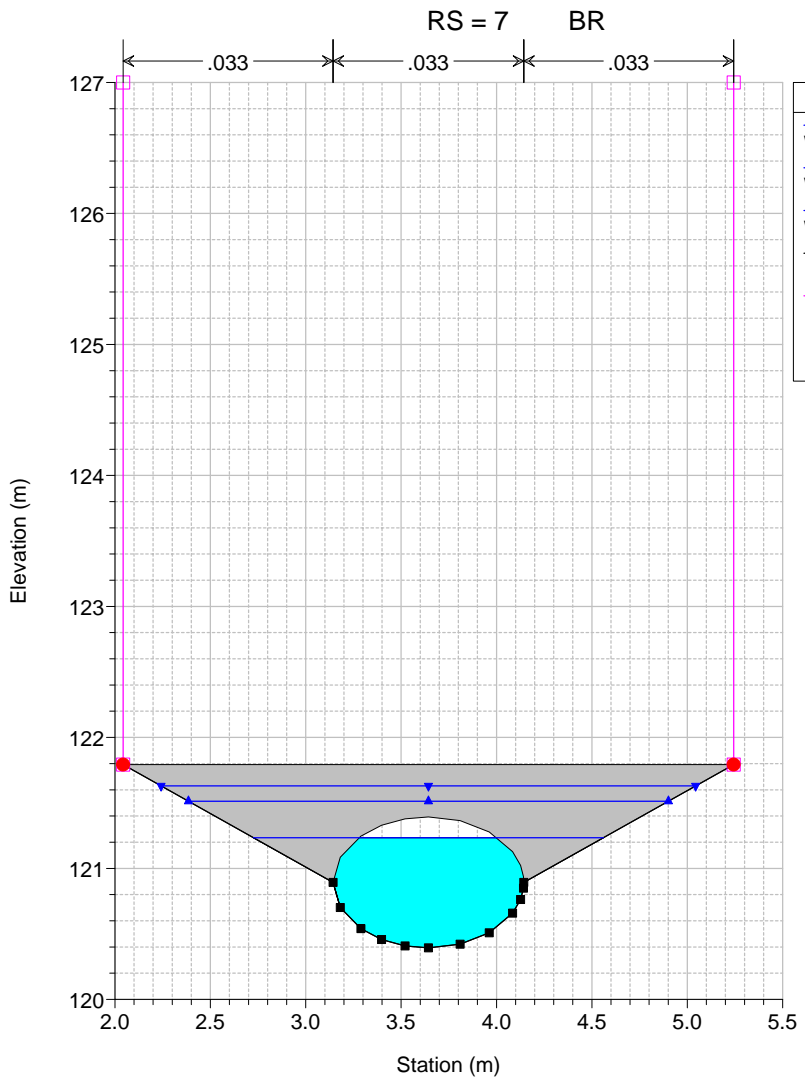
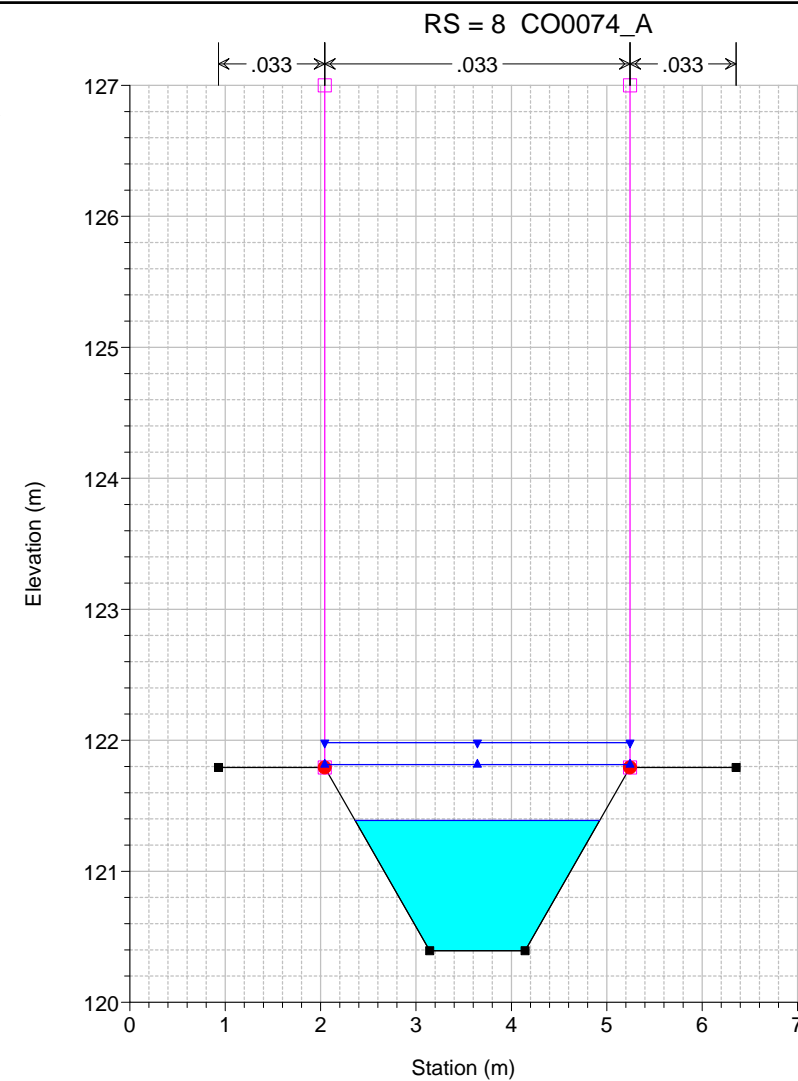
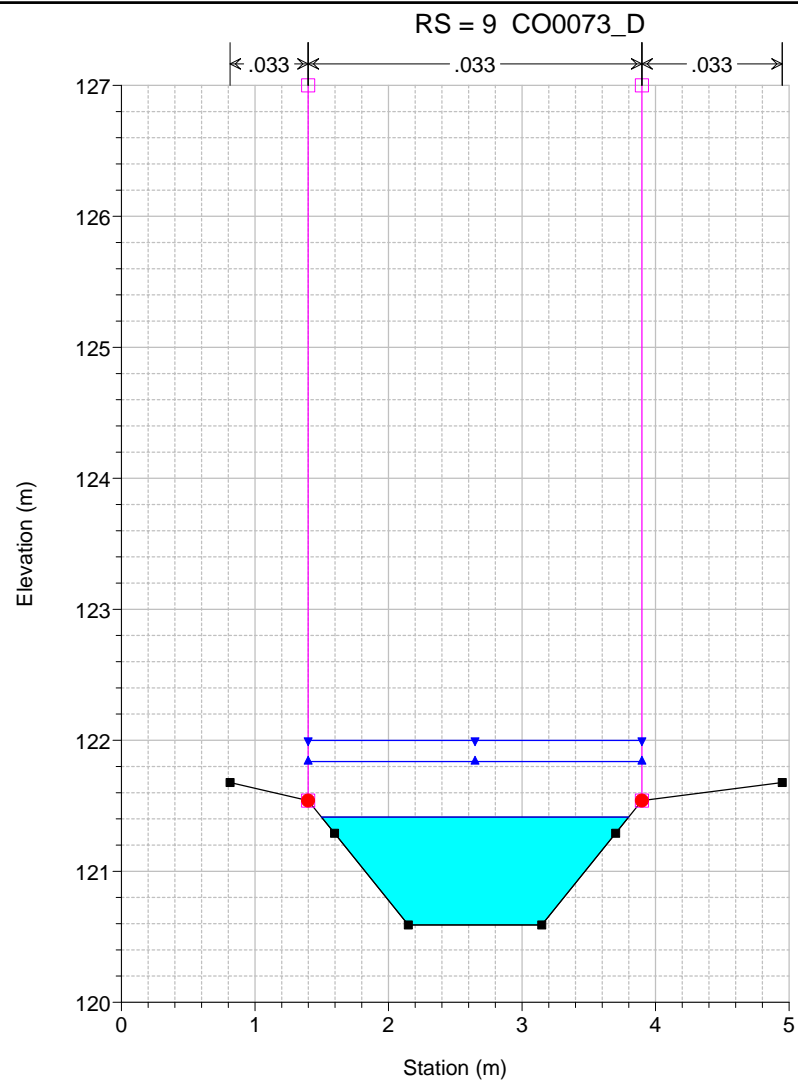
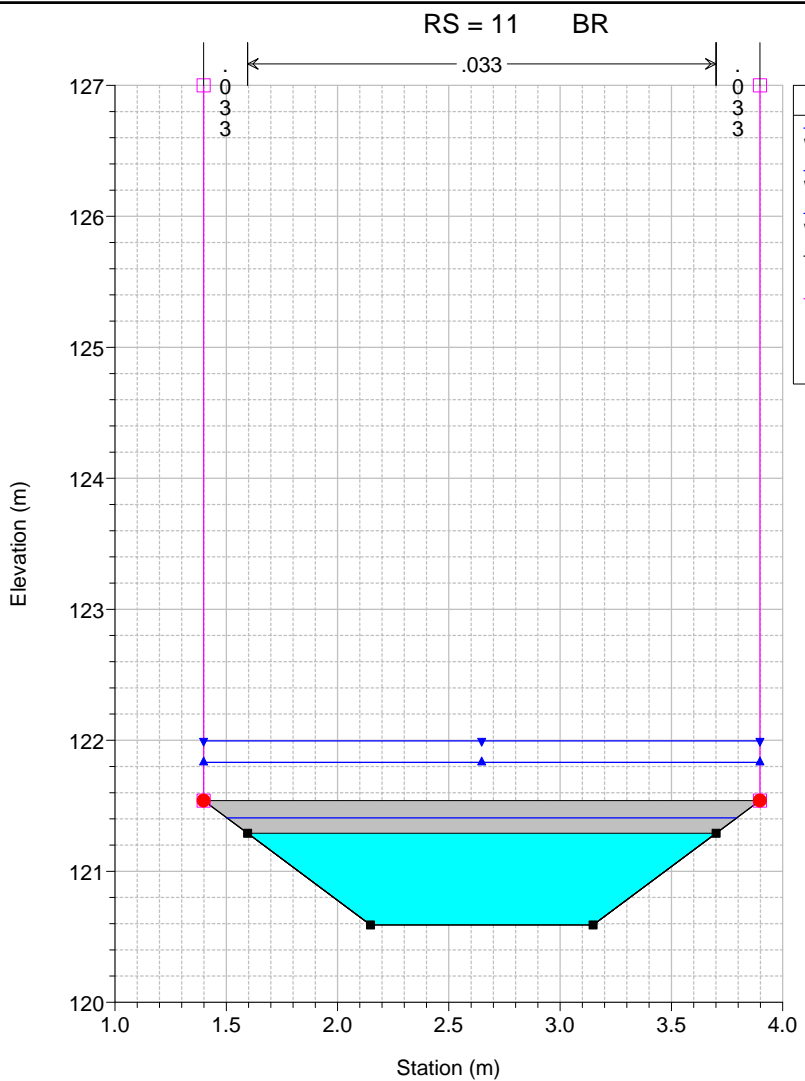

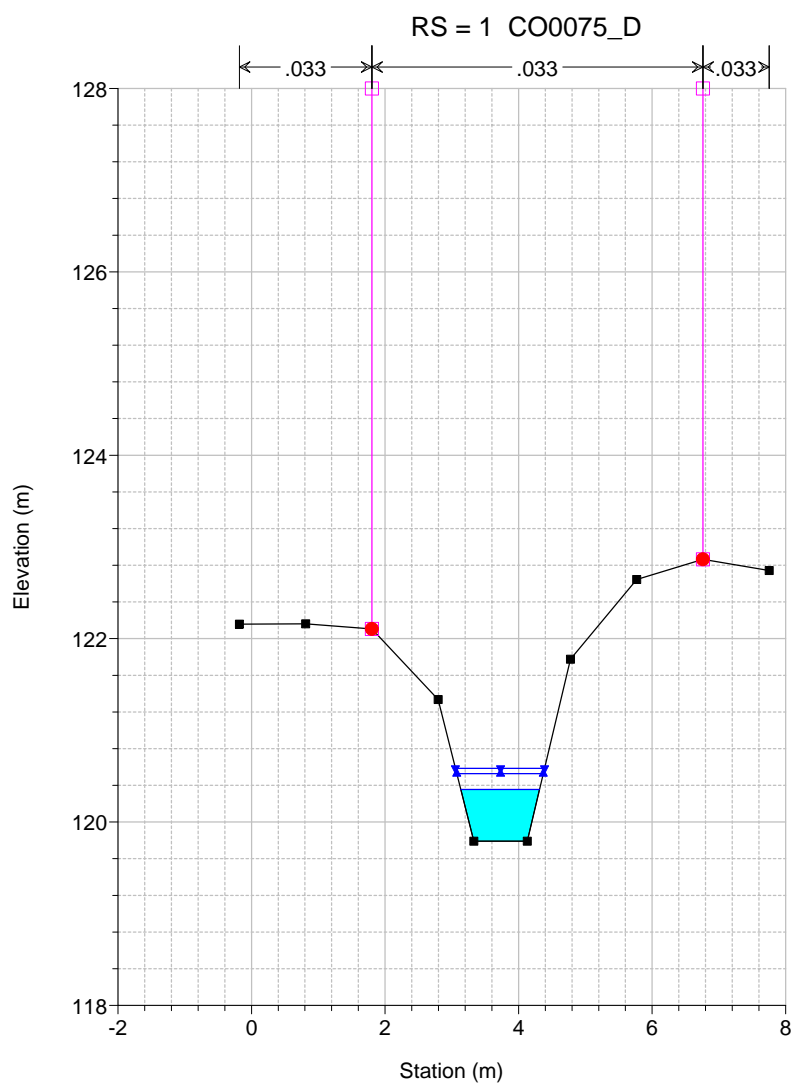
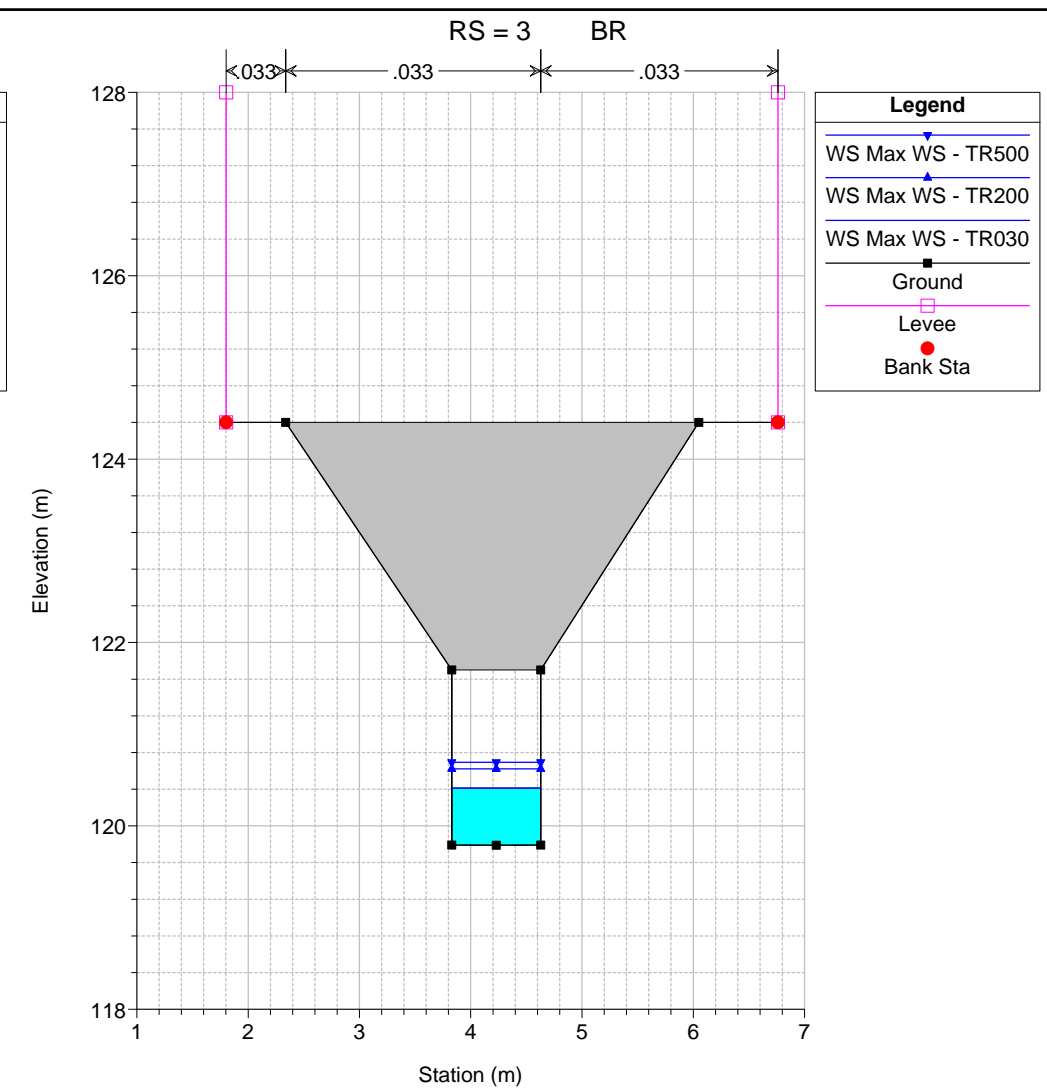
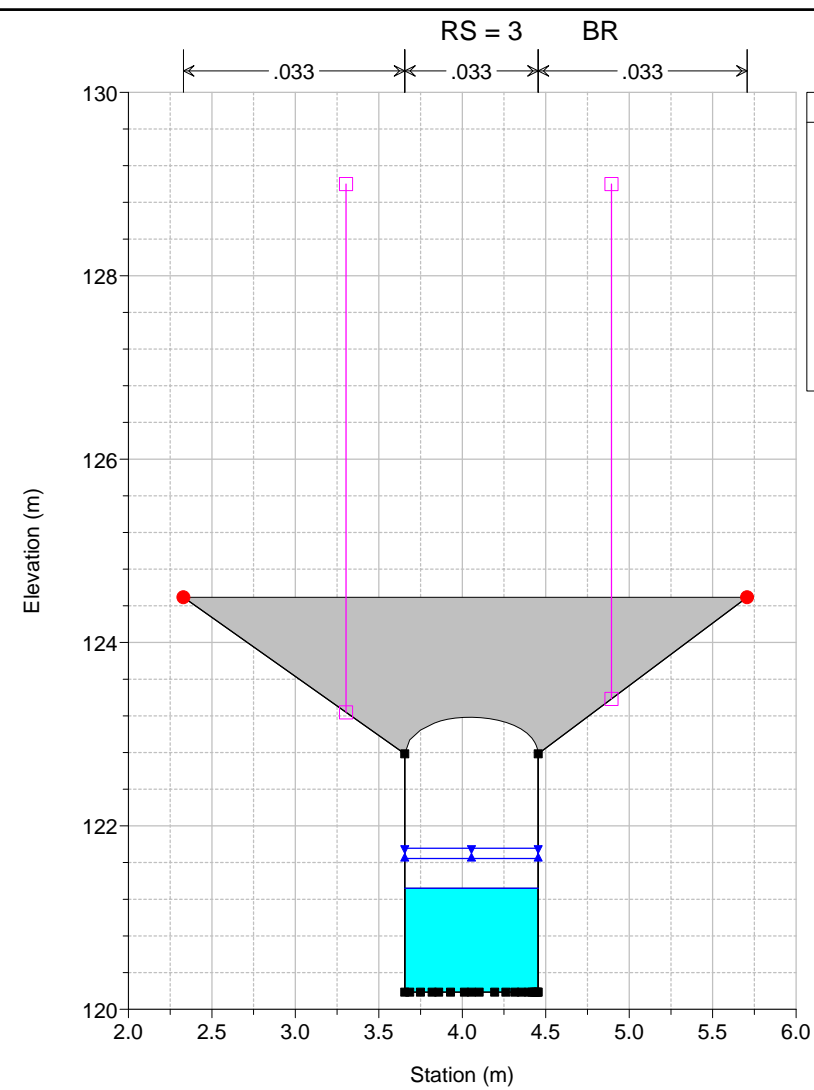
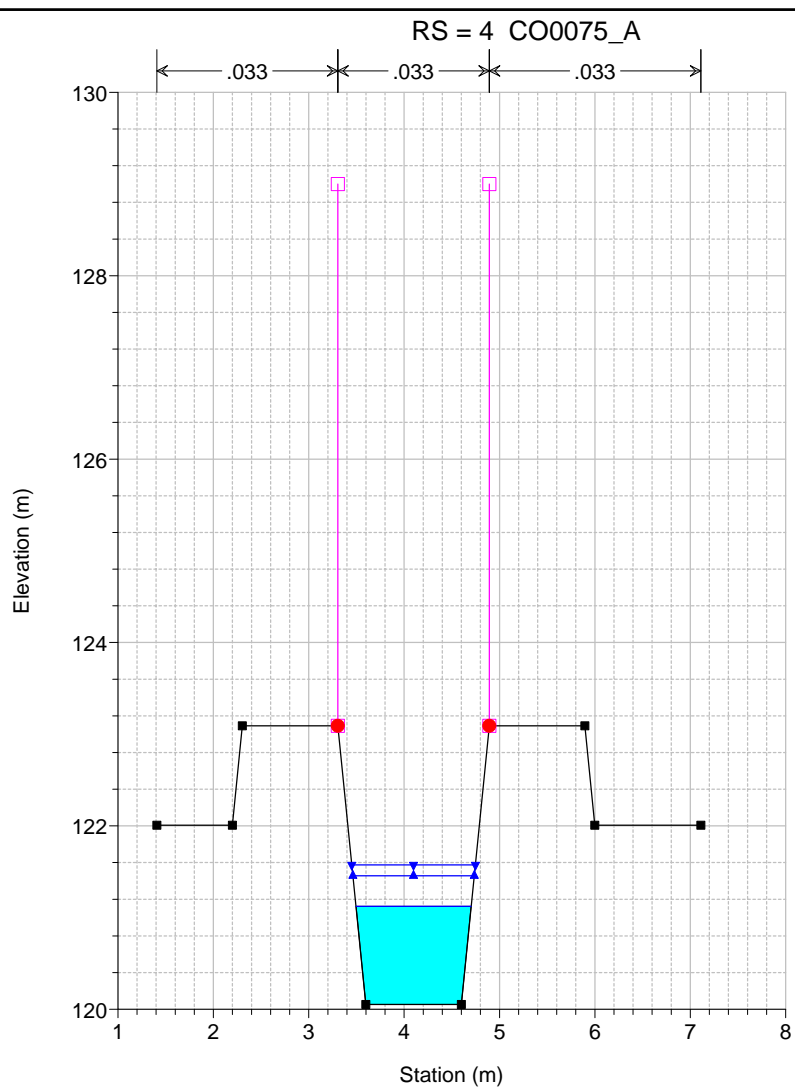

Sezioni fluviali
Torrente Resco
Tempo di ritorno: 30, 200 e 500 anni

