

# COMUNE DI MONTEMURLO

Provincia di Prato



## DEFINIZIONE E VERIFICA DI UNA IPOTESI PROGETTUALE PER LA RIDUZIONE DEL RISCHIO IDRAULICO NELLA FRAZIONE DI OSTE

CODICE:

# A02

ELABORATO:

### Sezioni fluviali e livelli idrometrici

SCALA

-

# WEST Systems

**West Systems s.r.l. divisione PHYSIS**  
- Ingegneria per l'ambiente

Viale Donato Giannotti, 24 - 50126 - Fi  
Tel. 055 461429 / 055 4684253  
Fax. 055 0460426  
Email. info@westsystems.com  
Pec. amministrazione@pec.westsystems.it

**PROGETTISTA:**

Ing. David Settesoldi

**COLLABORATORI TECNICI:**

Ing. Michele Catella  
Geol. Silvia Angelini

**COMMITTENTE:**

COMUNE DI MONTEMURLO  
Via Montalese, 472  
59013 - Montemurlo (PO)

02					
01	SECONDA EMISSIONE	29/10/2018	Ing. Michele Catella	Geol. Silvia Angelini	Ing. David Settesoldi
00	PRIMA EMISSIONE	18/01/2018	Dott. Stefano Liberatori	Geol. Silvia Angelini	Ing. David Settesoldi
REV.	DESCRIZIONE	DATA	REDATTO	VERIFICATO	APPROVATO
REVISIONE			DATA		
01			29/10/2018		



## INDICE

SEZIONI FLUVIALI TORRENTE AGNA .....	2
SEZIONI FLUVIALI FOSSO AGNACCINO - TRATTO 1 .....	59
SEZIONI FLUVIALI FOSSO AGNACCINO - TRATTO 2 .....	85
SEZIONI FLUVIALI FOSSO AGNACCINO - TRATTO 3 .....	100
SEZIONI FLUVIALI TORRENTE BAGNOLO .....	114
SEZIONI FLUVIALI TORRENTE BURE - TRATTO 1 .....	169
SEZIONI FLUVIALI TORRENTE BURE - TRATTO 2 .....	238
SEZIONI FLUVIALI TORRENTE BURE - TRATTO 3 .....	247
SEZIONI FLUVIALI TORRENTE BURE - TRATTO 4 .....	253
SEZIONI FLUVIALI TORRENTE CALICE.....	255
SEZIONI FLUVIALI TORRENTE CALICINO .....	268
SEZIONI FLUVIALI FOSSO FICARELLO .....	284
SEZIONI FLUVIALI FOSSO DI GUARDIA.....	331
SEZIONI FLUVIALI FOSSO FUNANDOLA - TRATTO 1.....	335
SEZIONI FLUVIALI FOSSO FUNANDOLA - TRATTO 2.....	354
SEZIONI FLUVIALI FOSSO FUNANDOLA - TRATTO 3.....	395
SEZIONI FLUVIALI FOSSO FUNANDOLA - TRATTO DV .....	428
SEZIONI FLUVIALI FOSSO GRAMIGNETO .....	440
SEZIONI FLUVIALI FOSSO MENDACIONE - TRATTO 0.....	467
SEZIONI FLUVIALI FOSSO MENDACIONE - TRATTO 1.....	502
SEZIONI FLUVIALI FOSSO MENDACIONE - TRATTO 2.....	538
SEZIONI FLUVIALI FOSSO MENDACIONE - TRATTO 3.....	554
SEZIONI FLUVIALI FOSSO POLTROVA.....	570
SEZIONI FLUVIALI FOSSO SELVAVECCHIA .....	584
SEZIONI FLUVIALI FOSSO SELVAVECCHIA FO.....	620
SEZIONI FLUVIALI FOSSO STREGALE - TRATTO 1 .....	627
SEZIONI FLUVIALI FOSSO STREGALE - TRATTO 2 .....	662

SEZIONI FLUVIALI  
TORRENTE AGNA

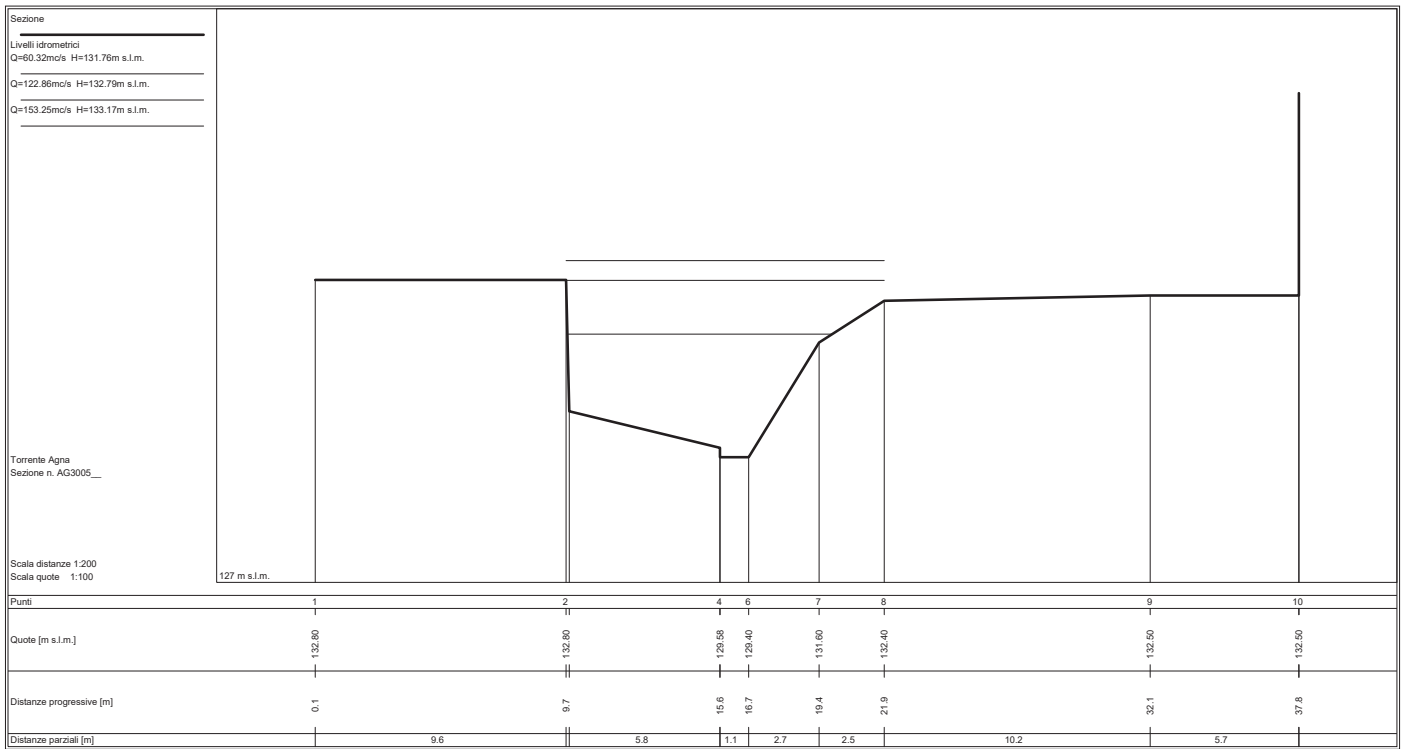
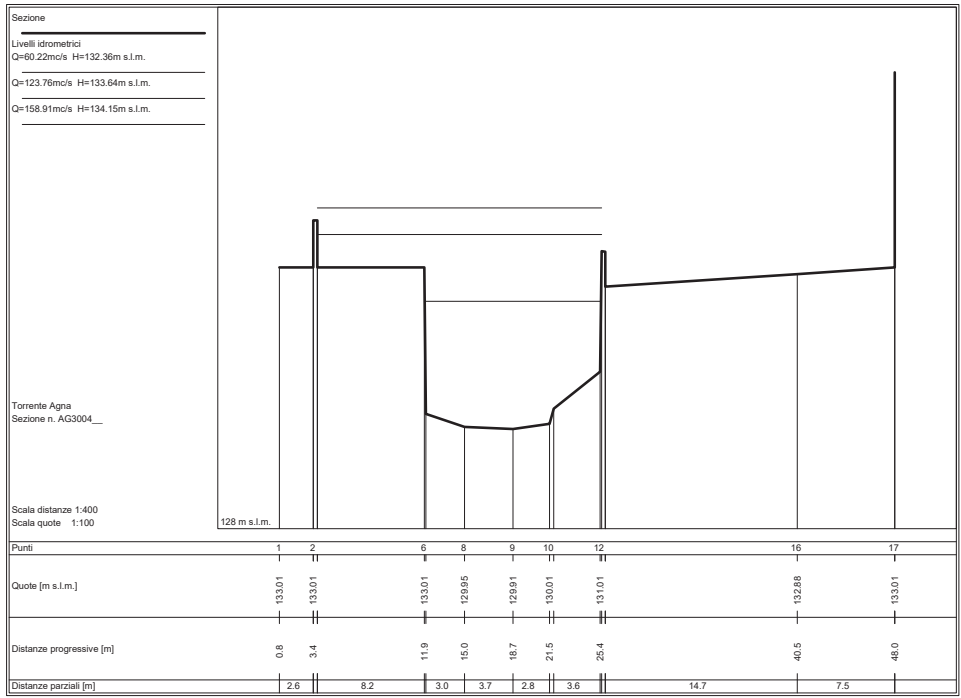

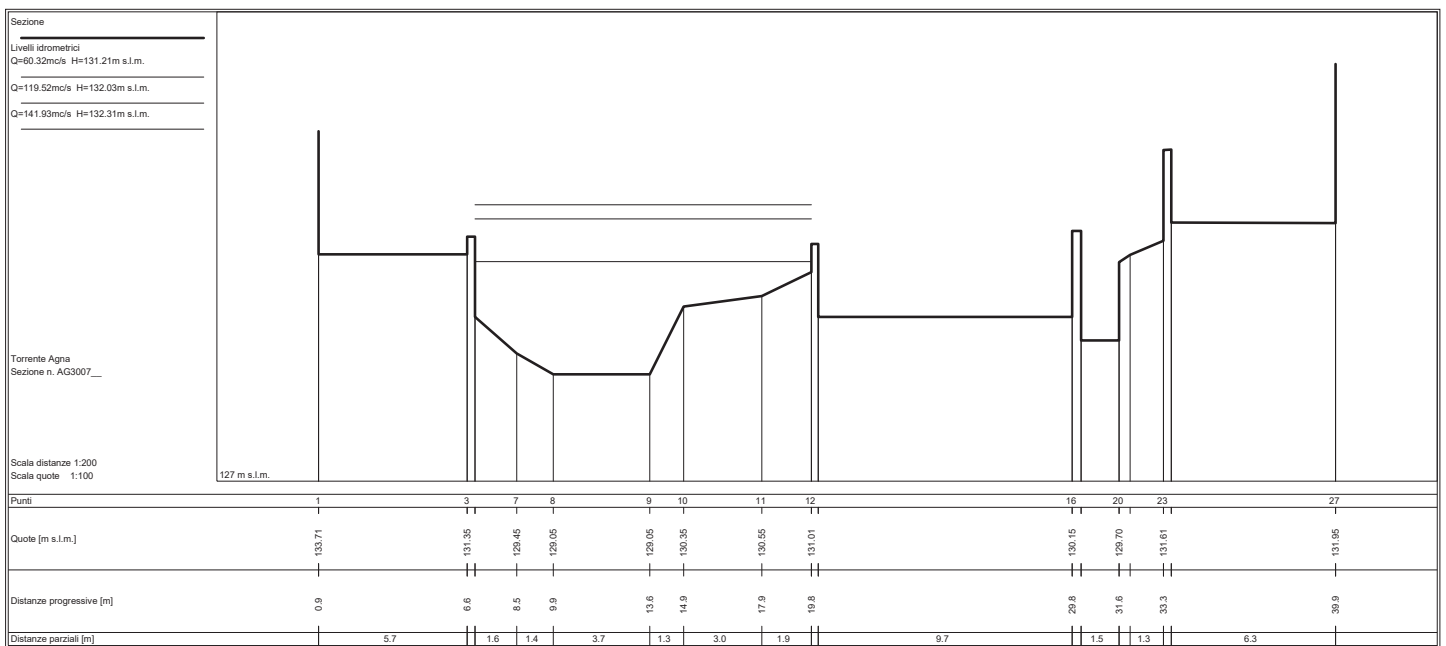
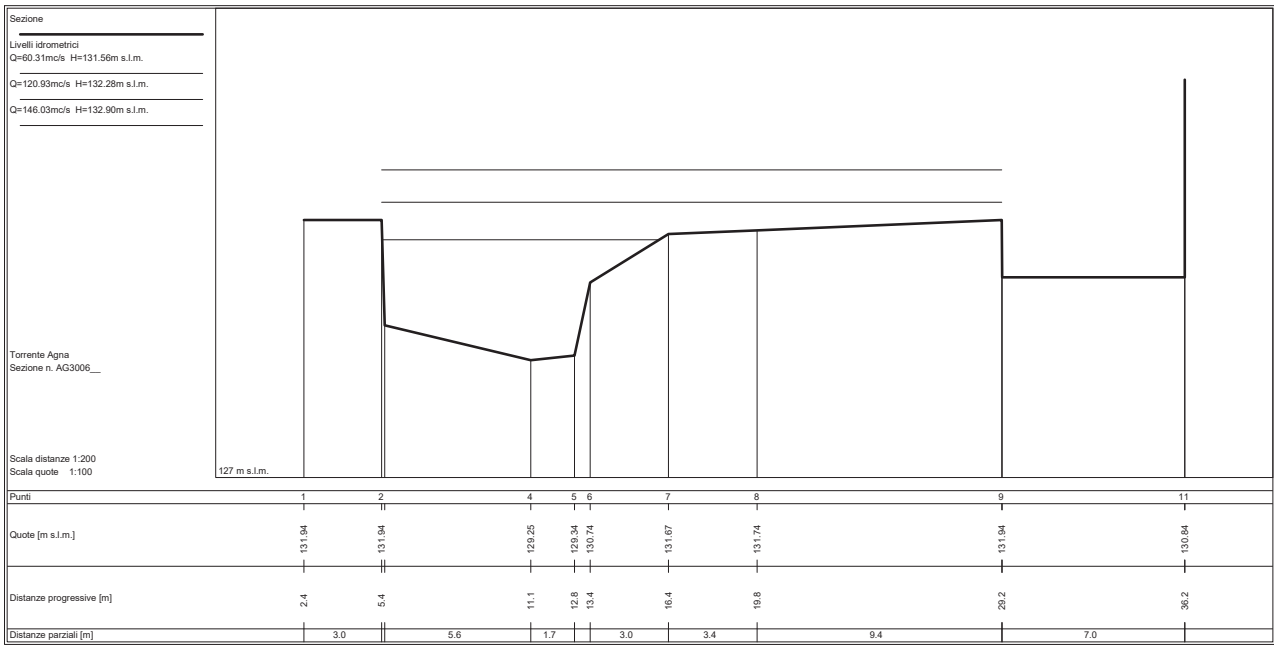

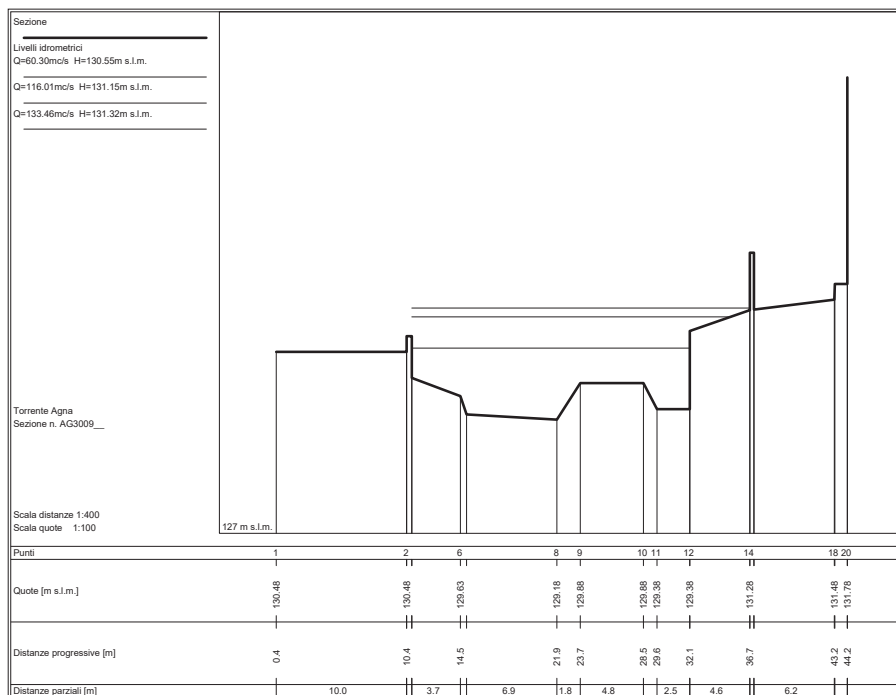
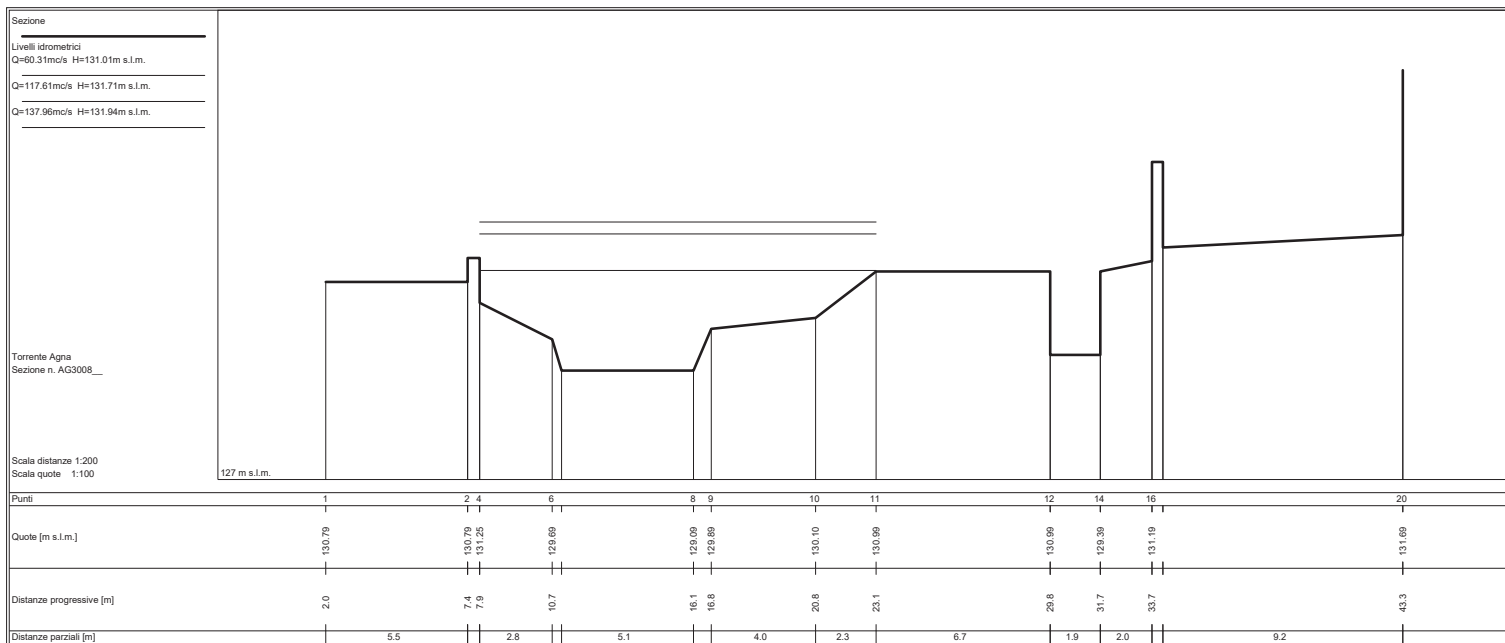

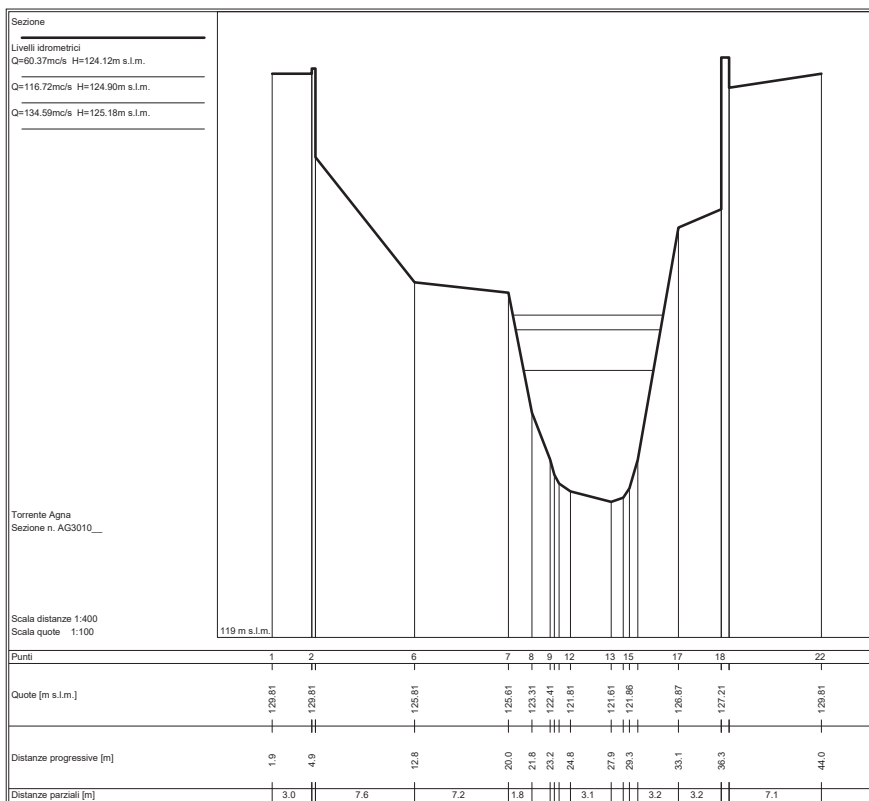
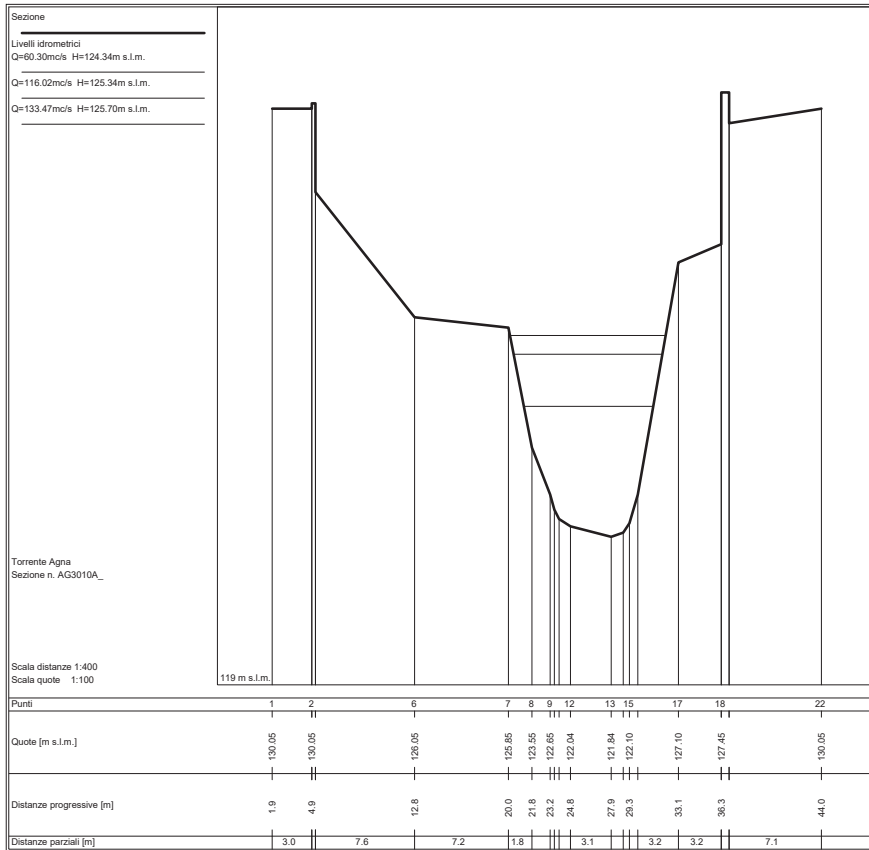



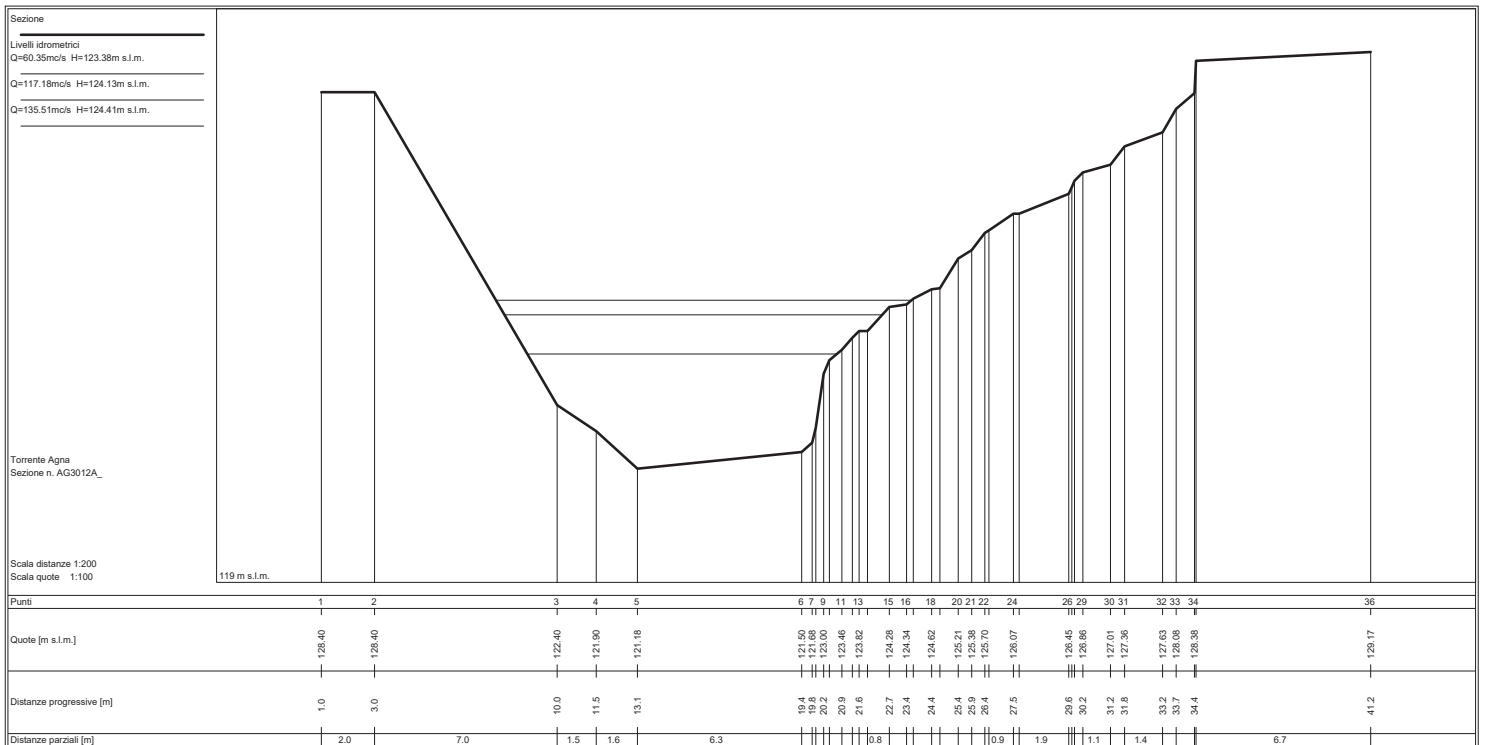
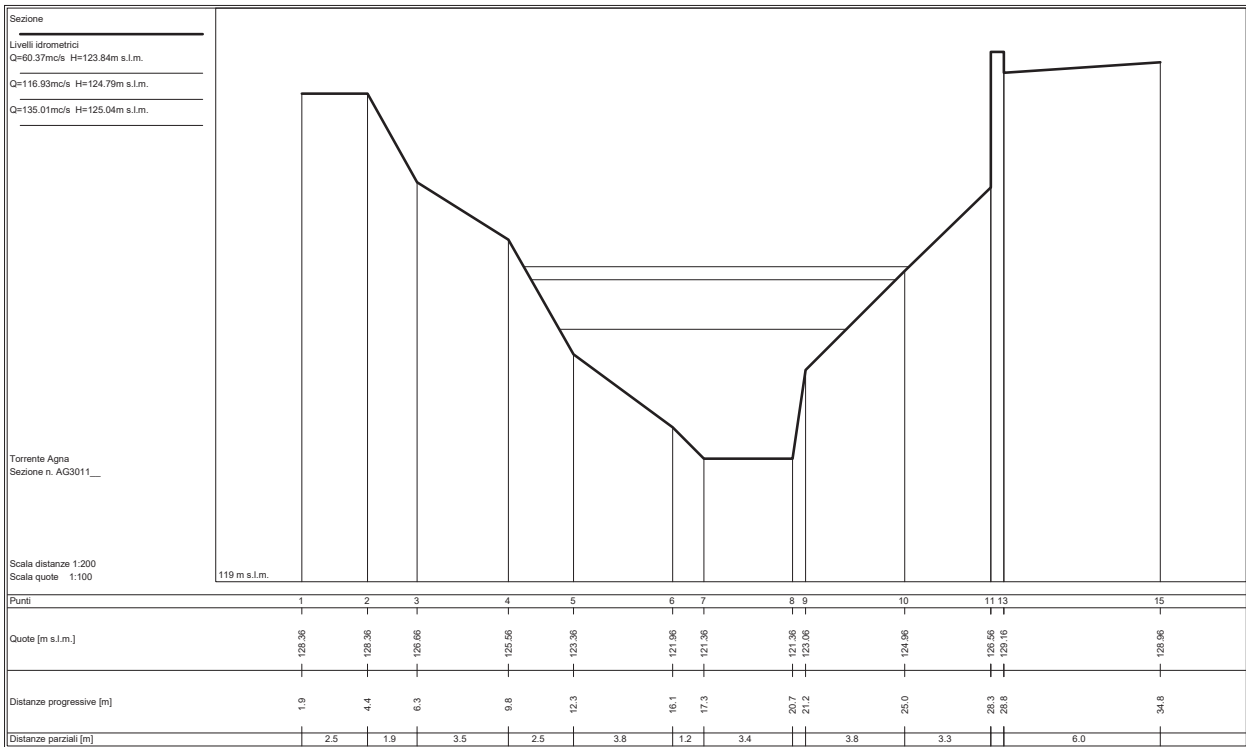

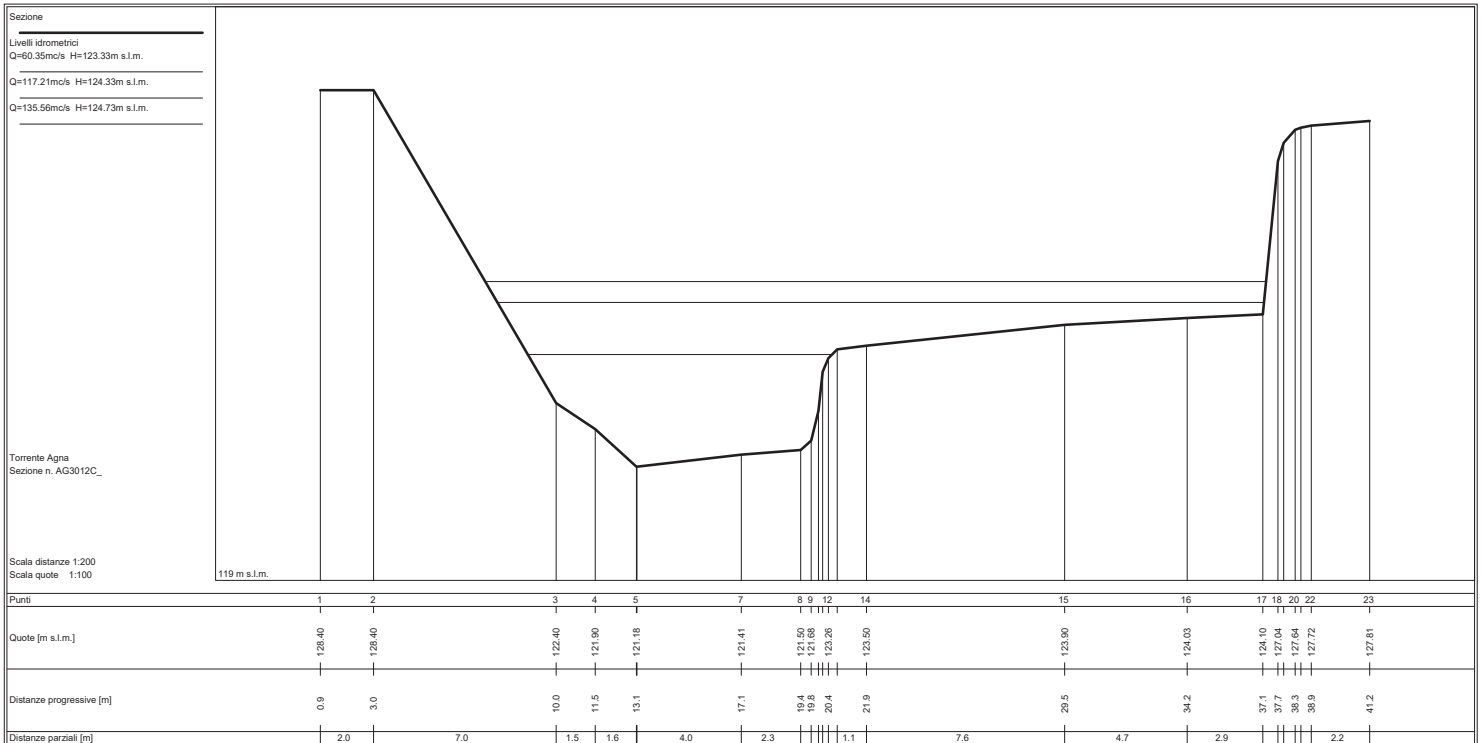
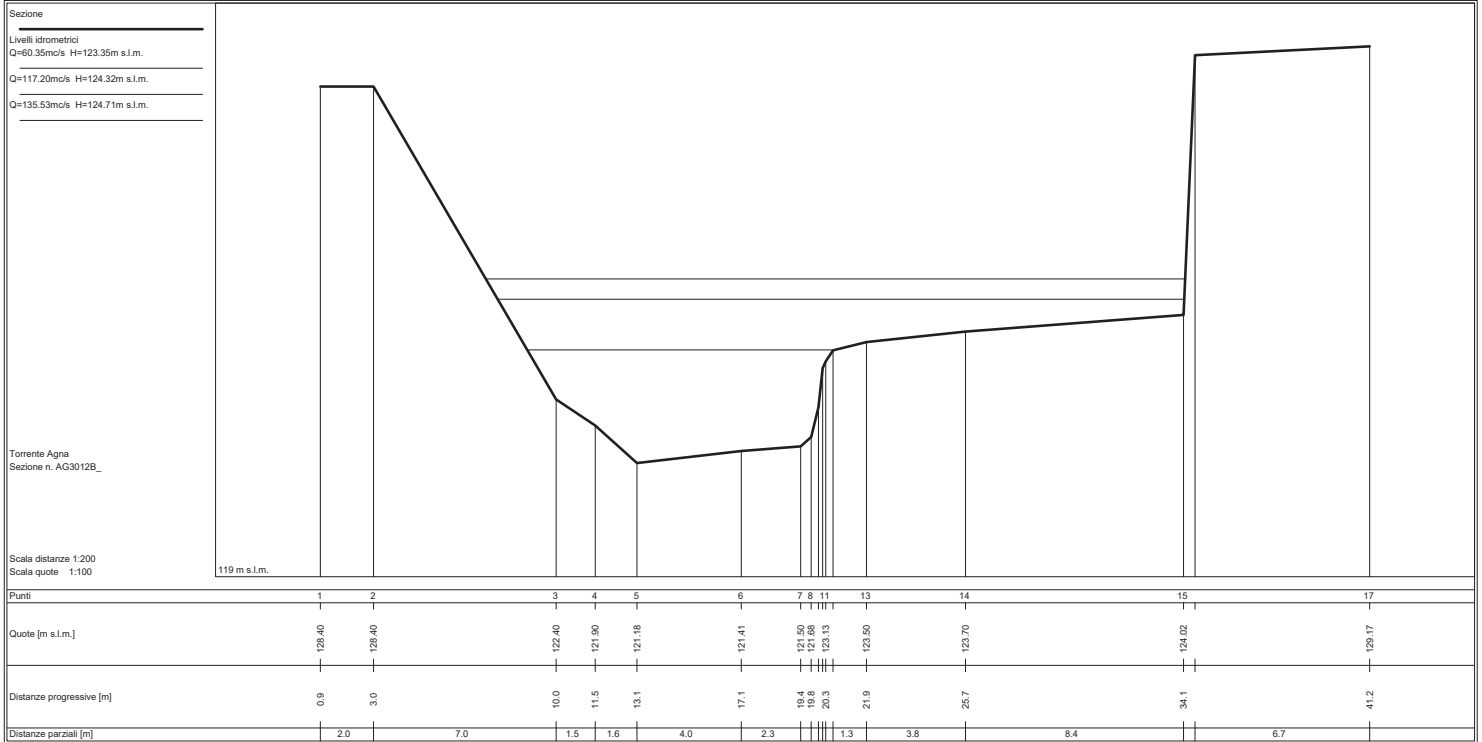

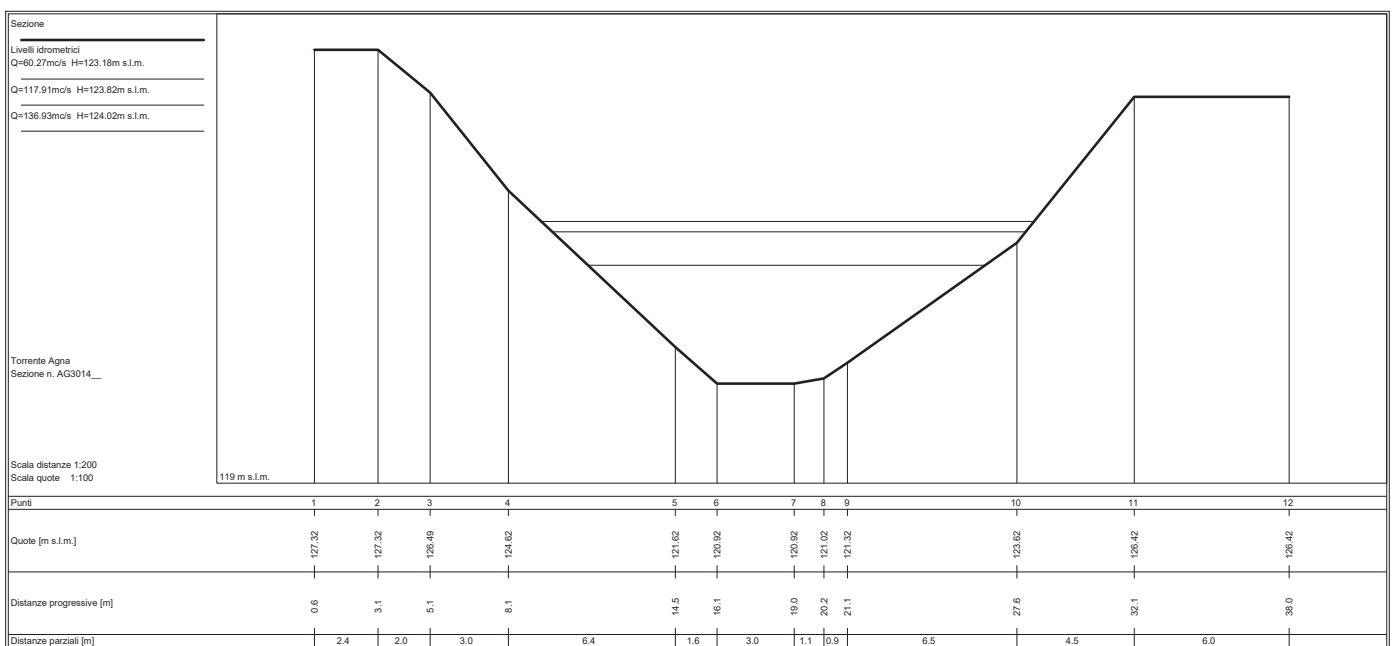
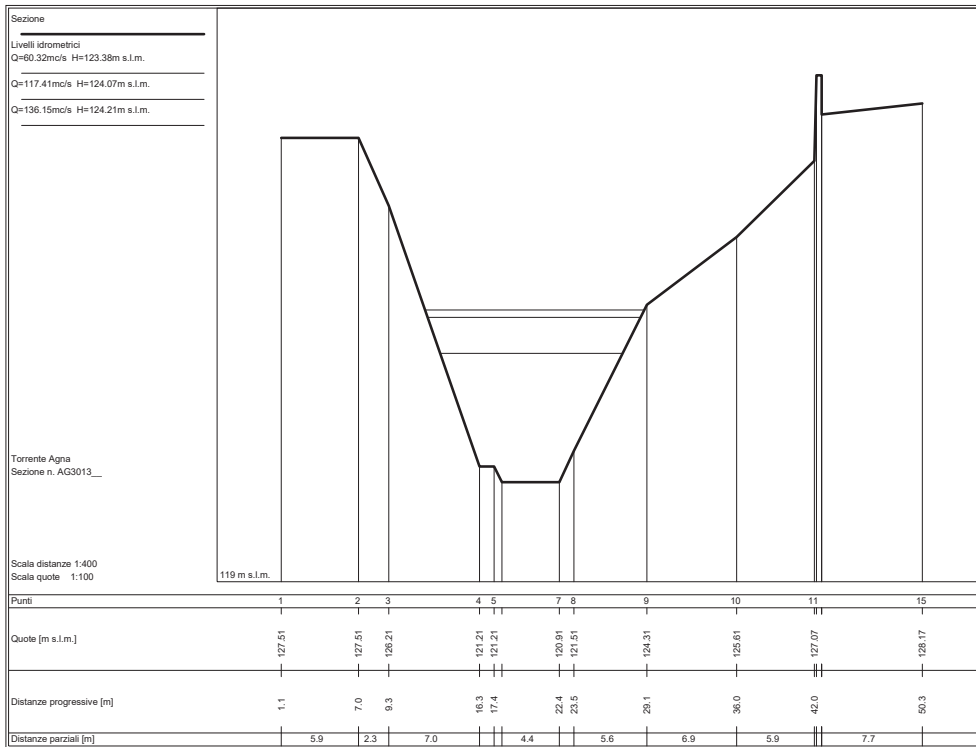

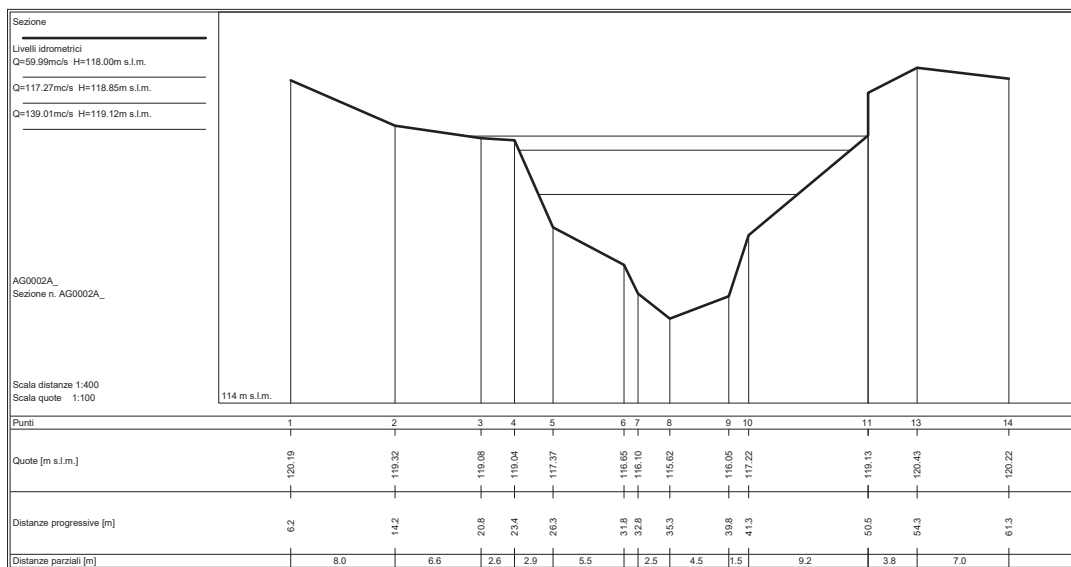
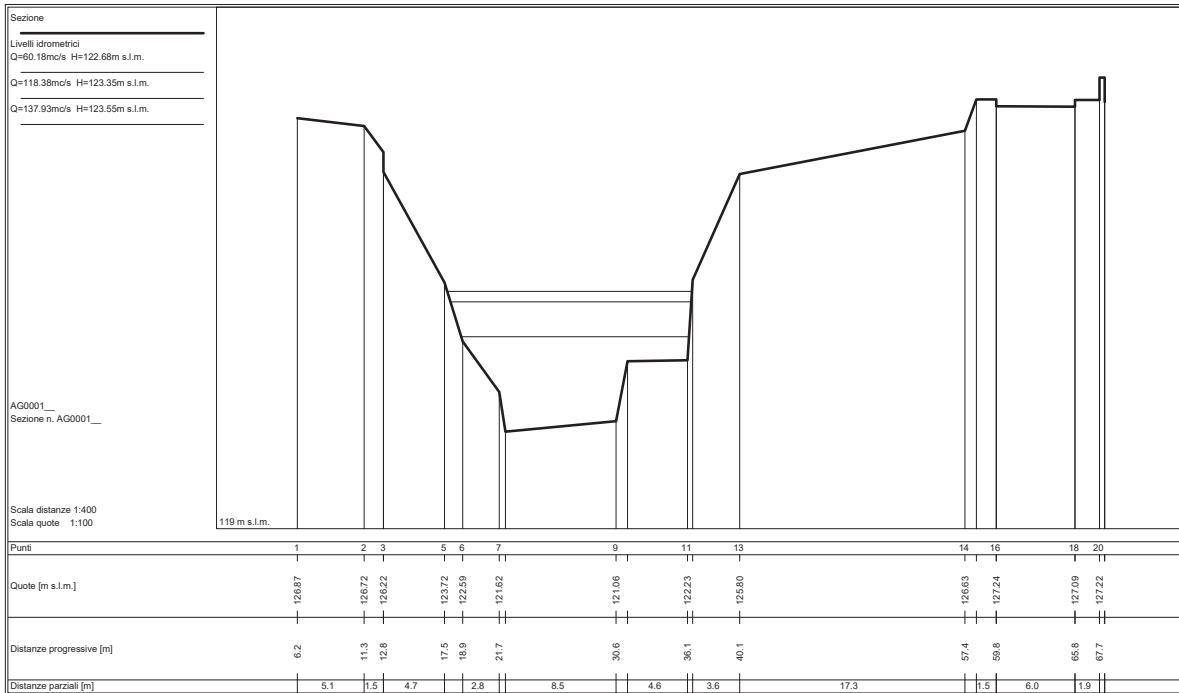

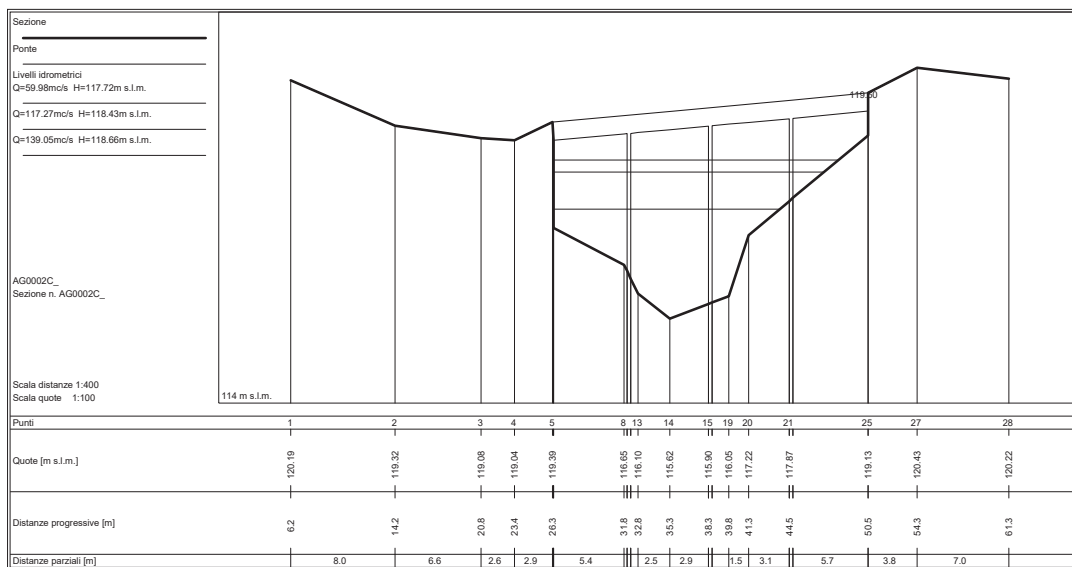
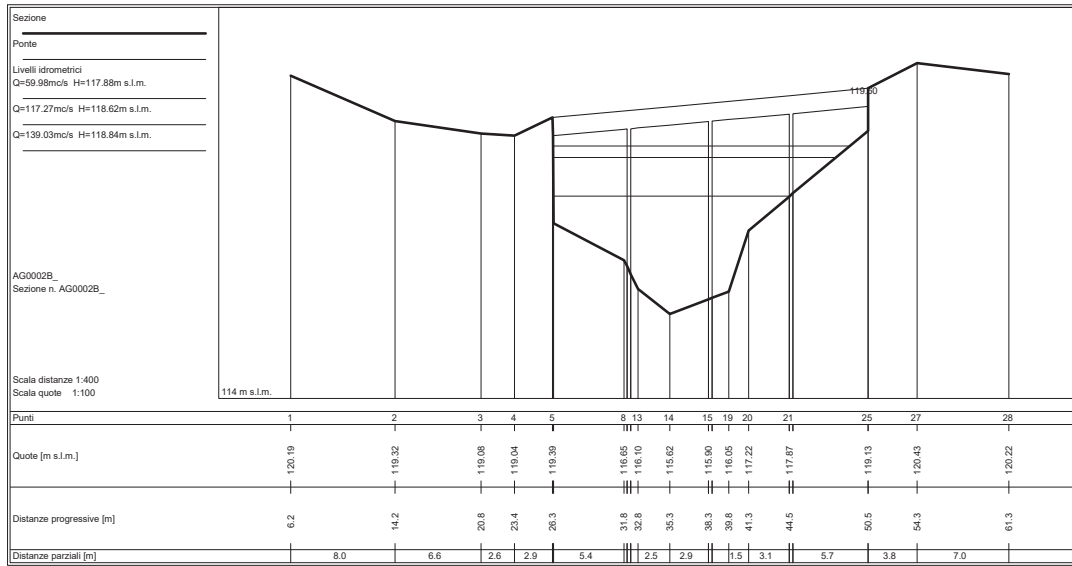

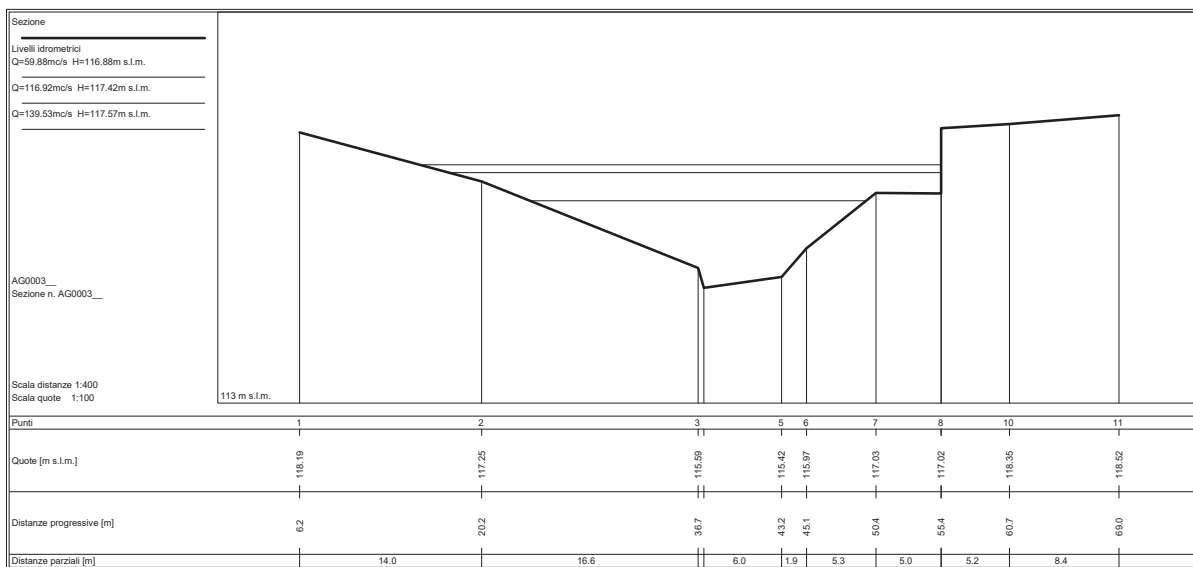
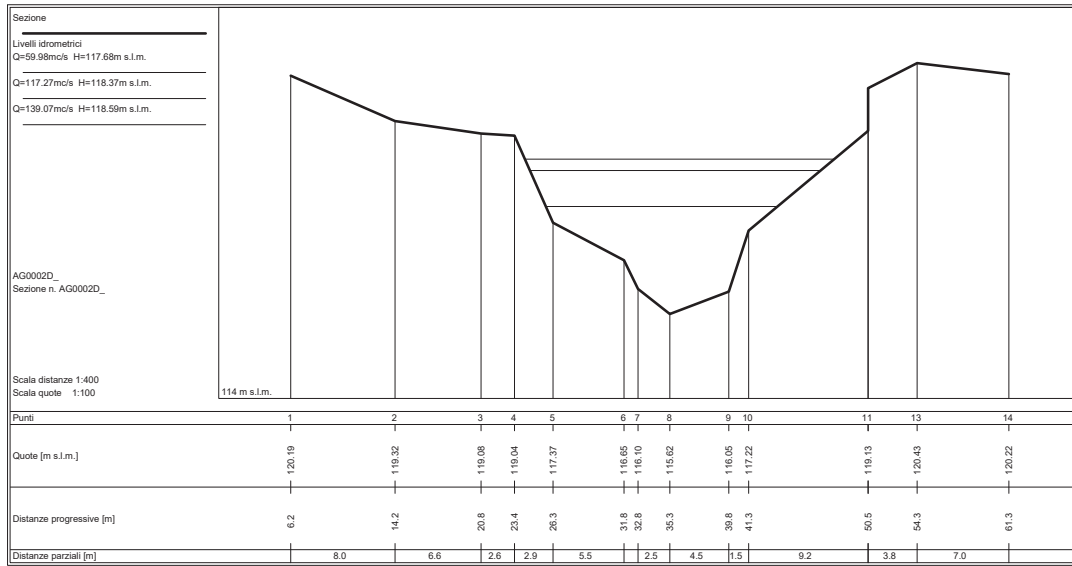

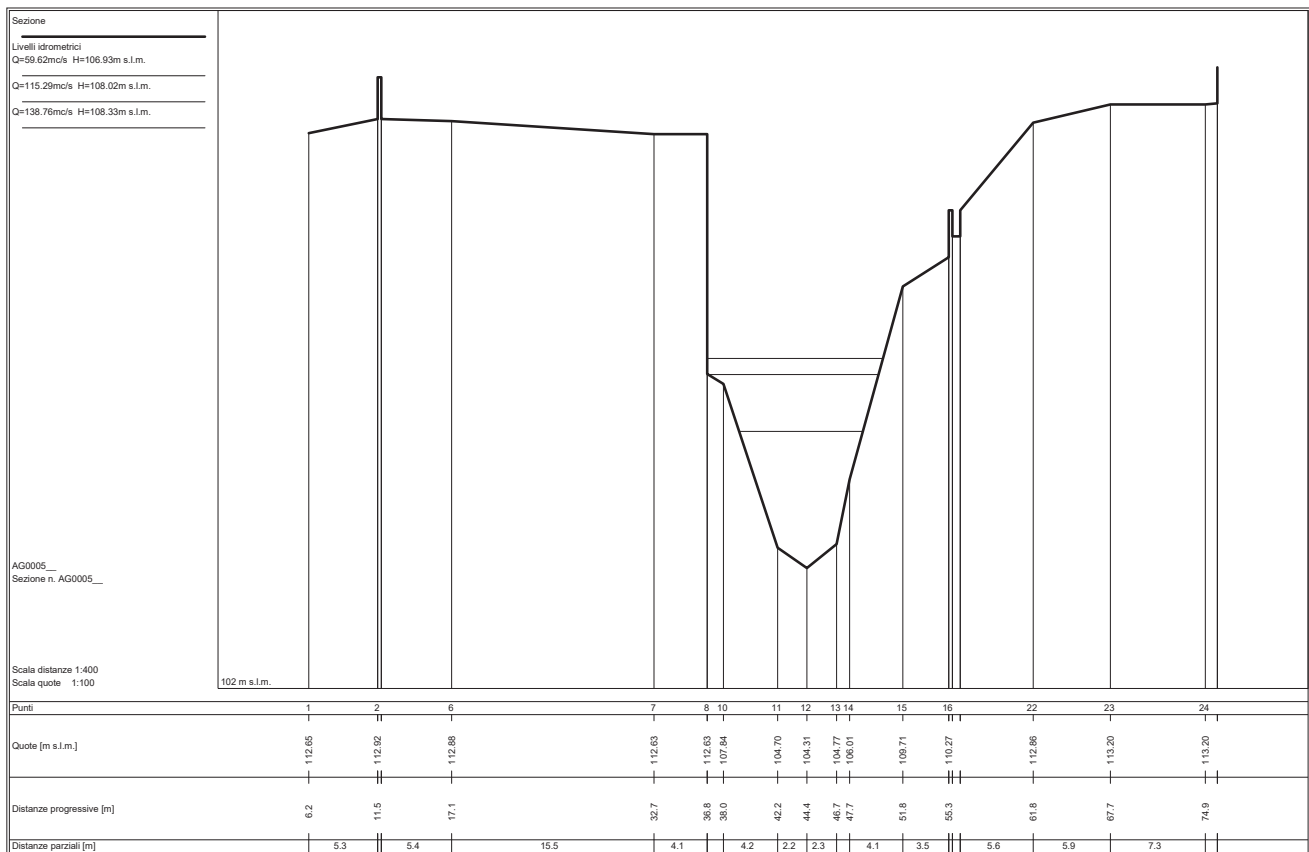
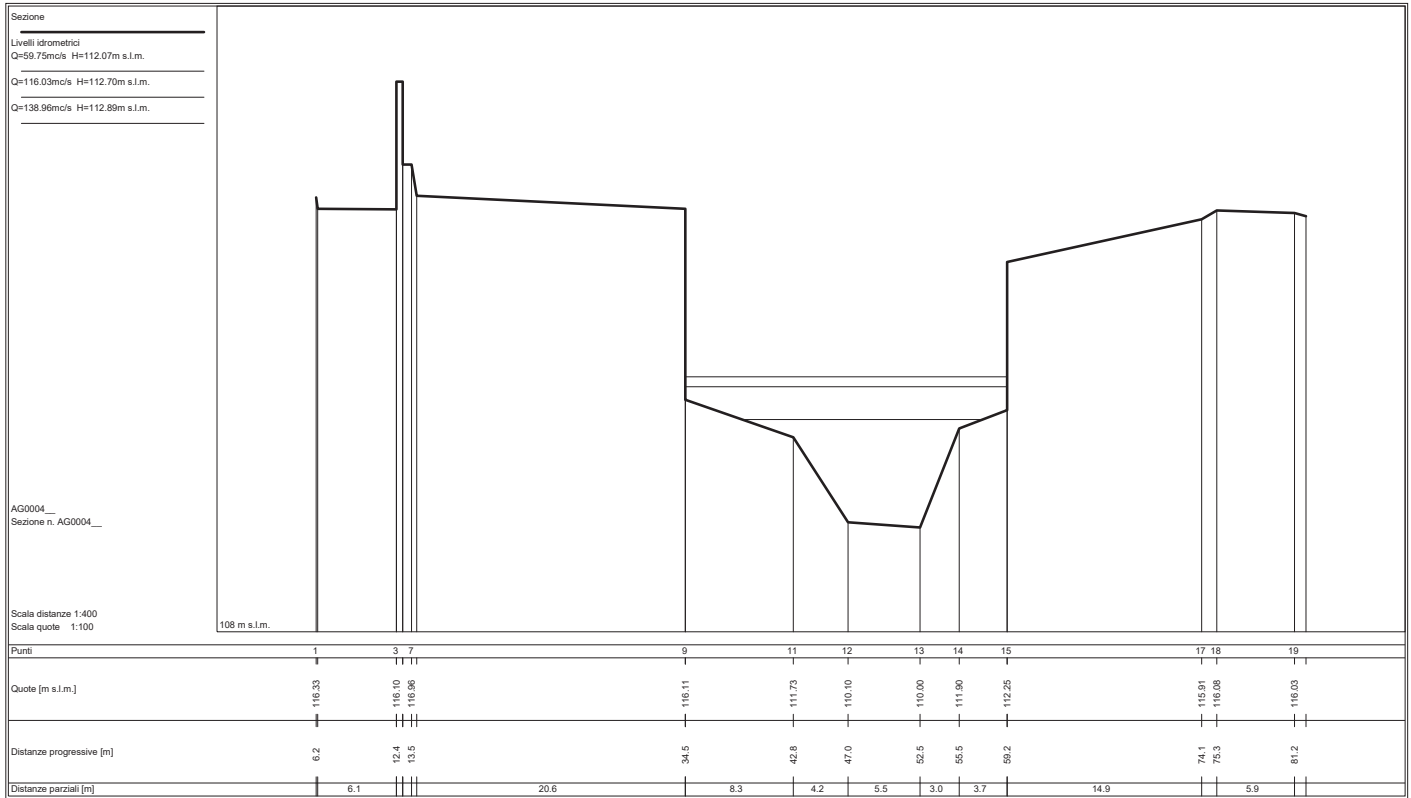

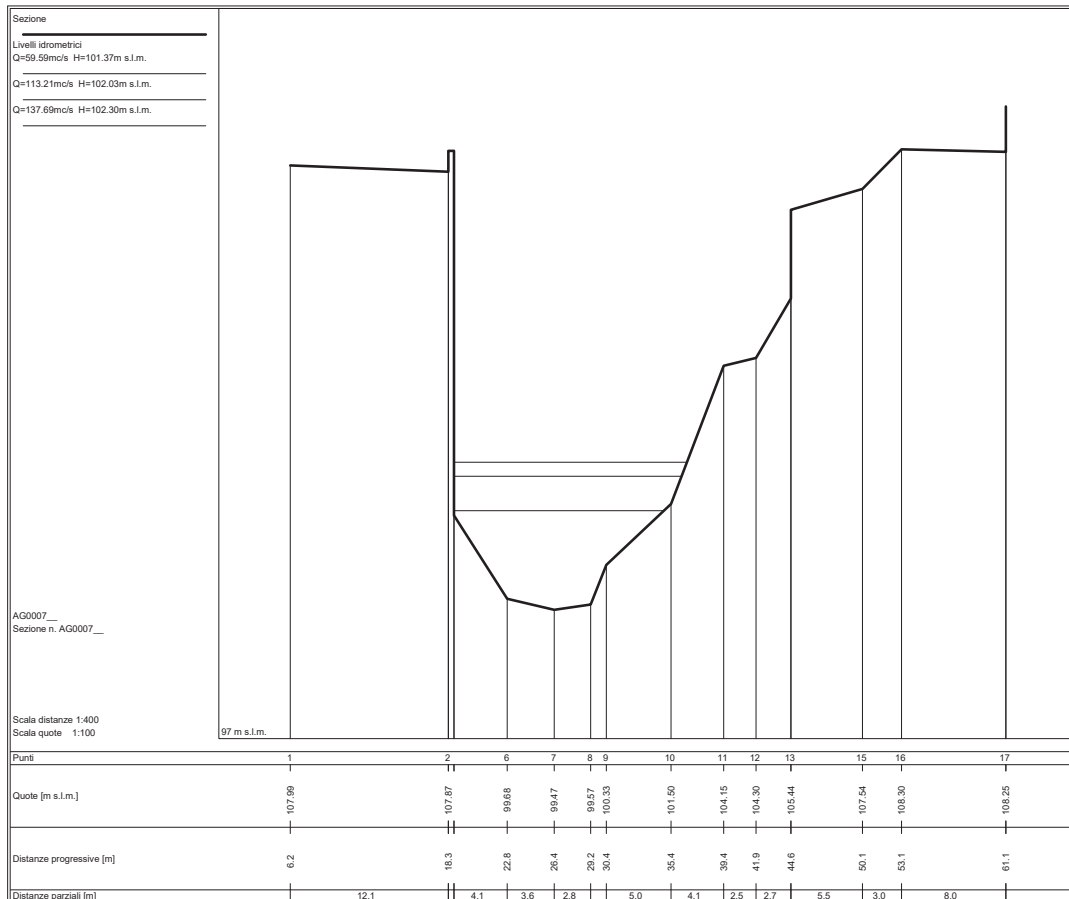
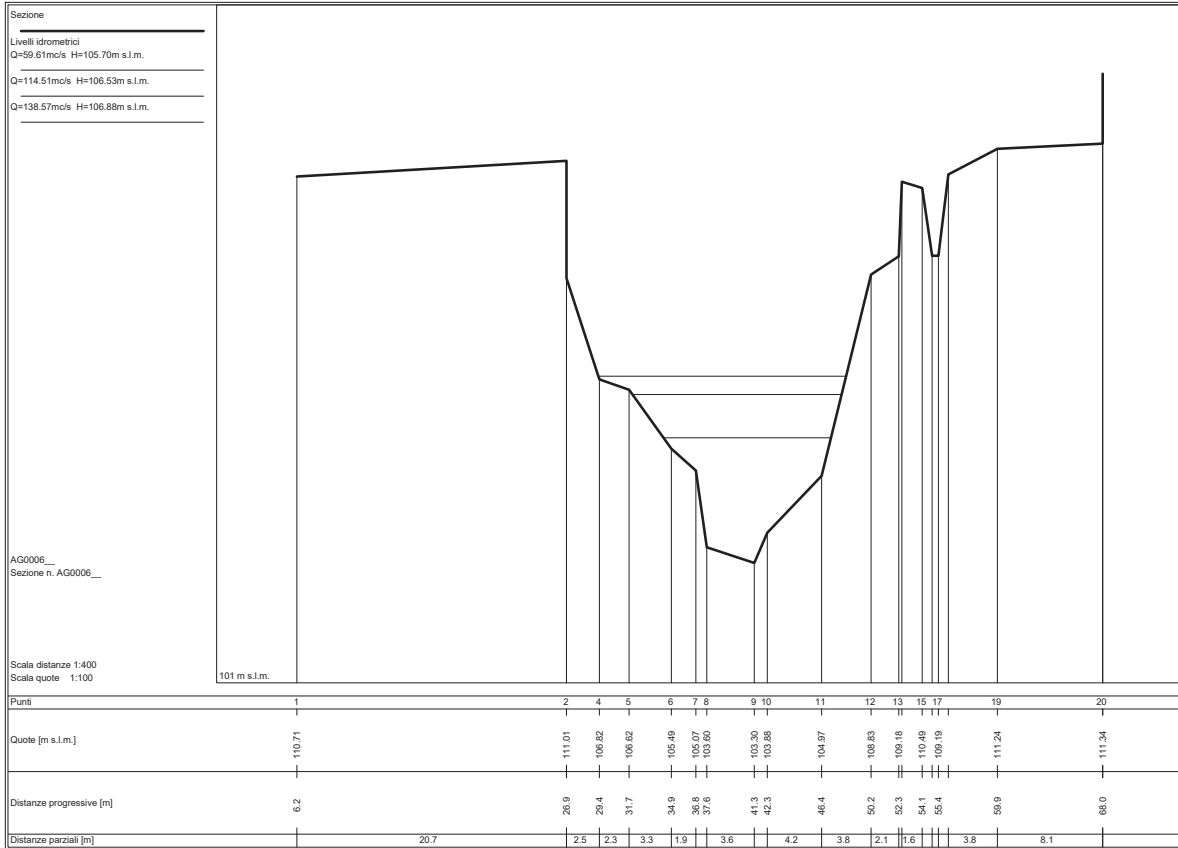



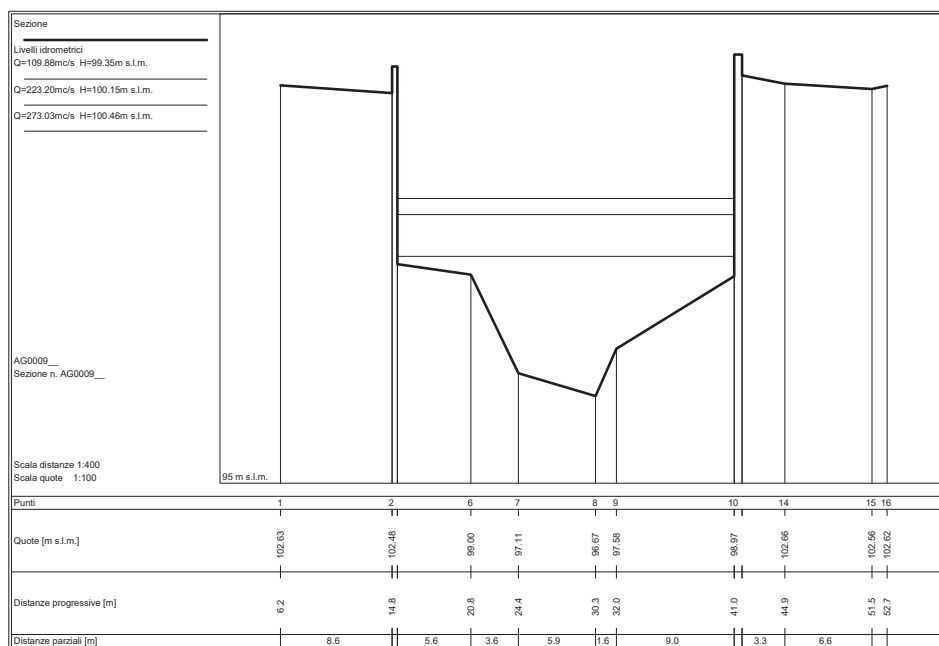
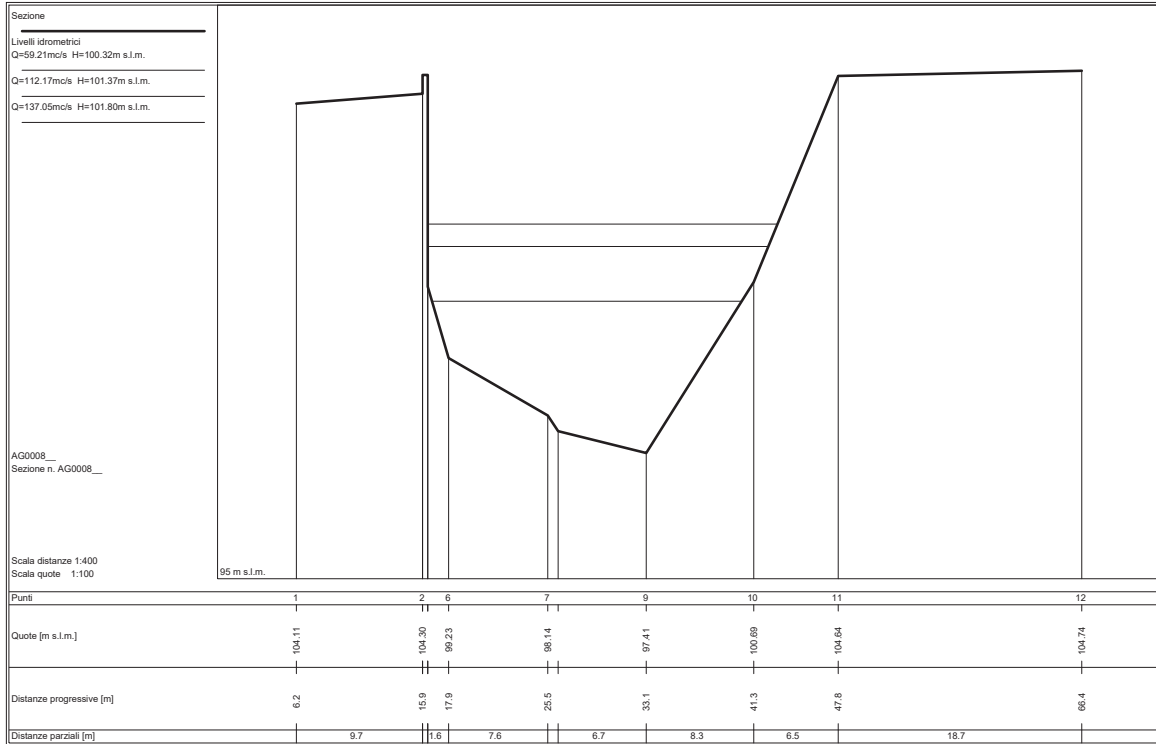

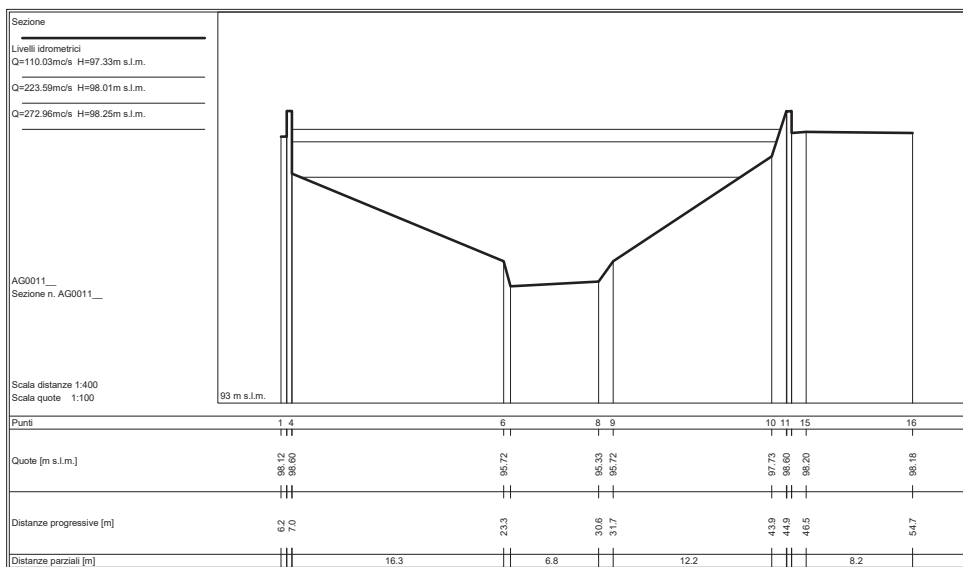
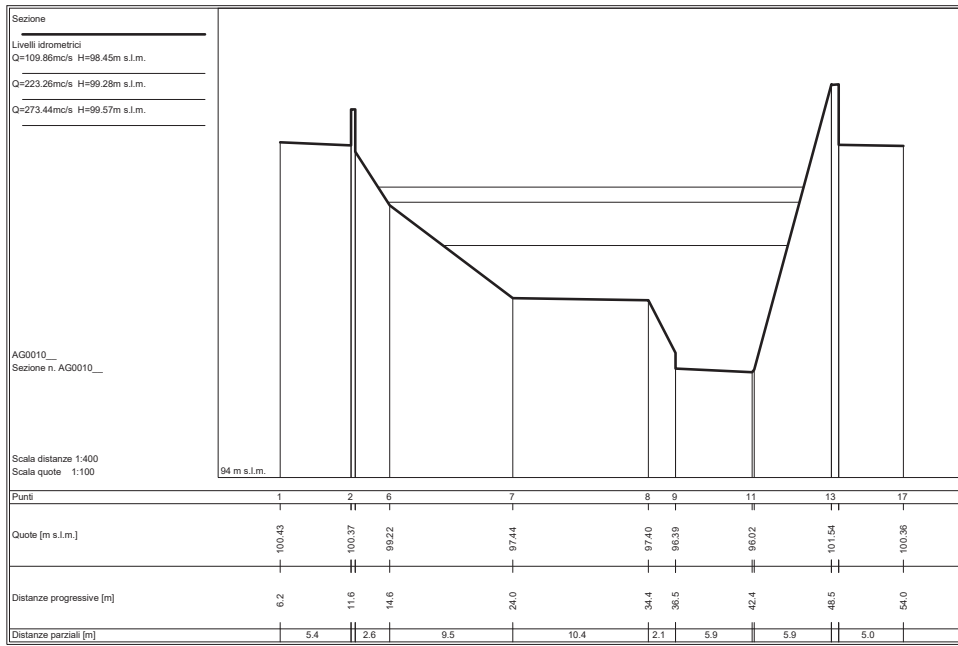

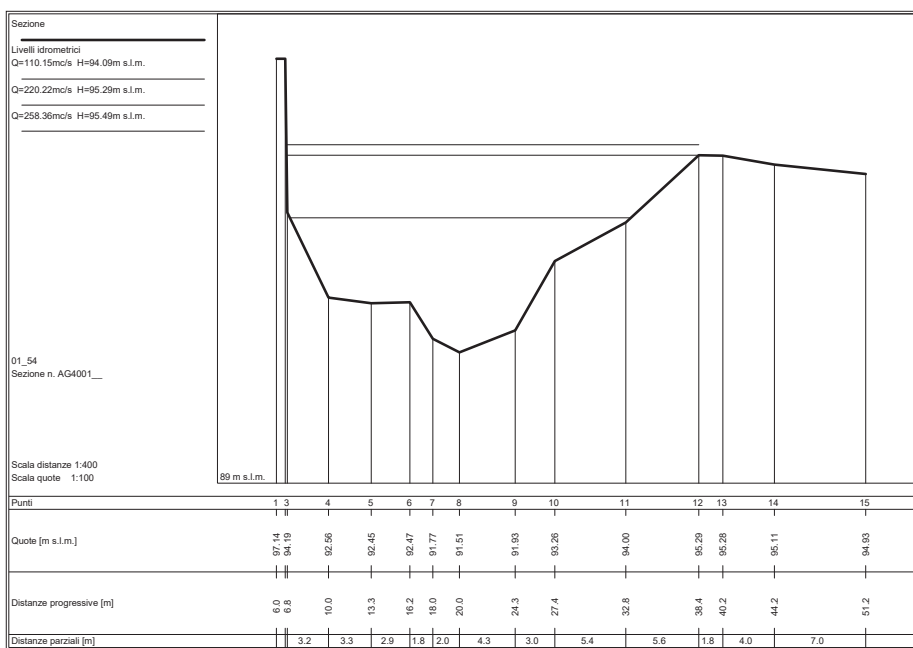
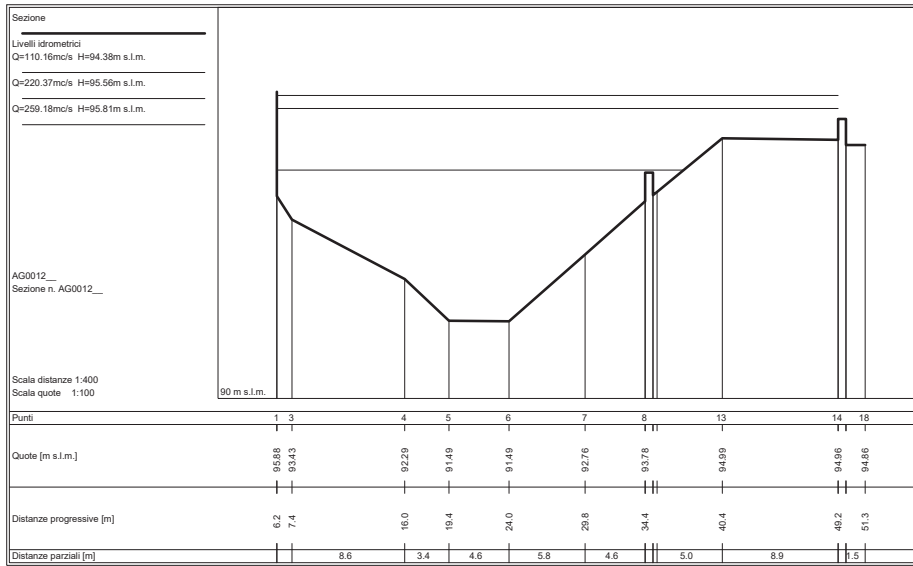

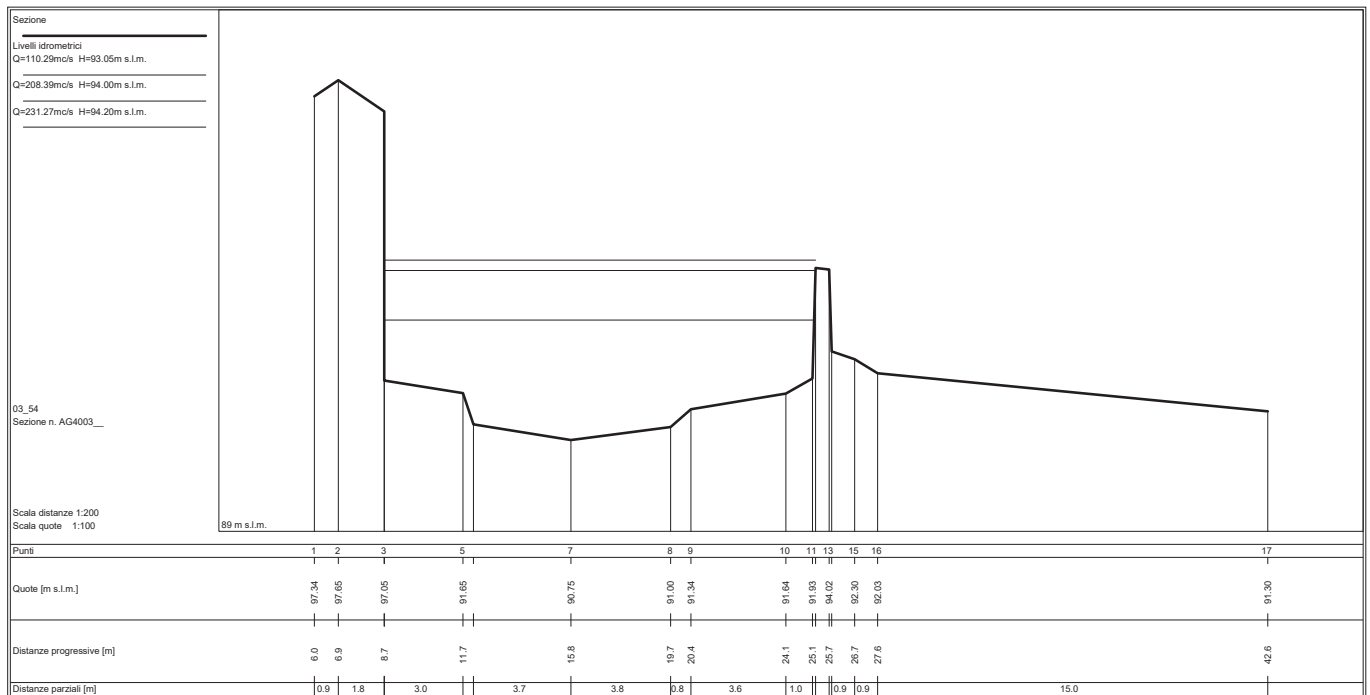
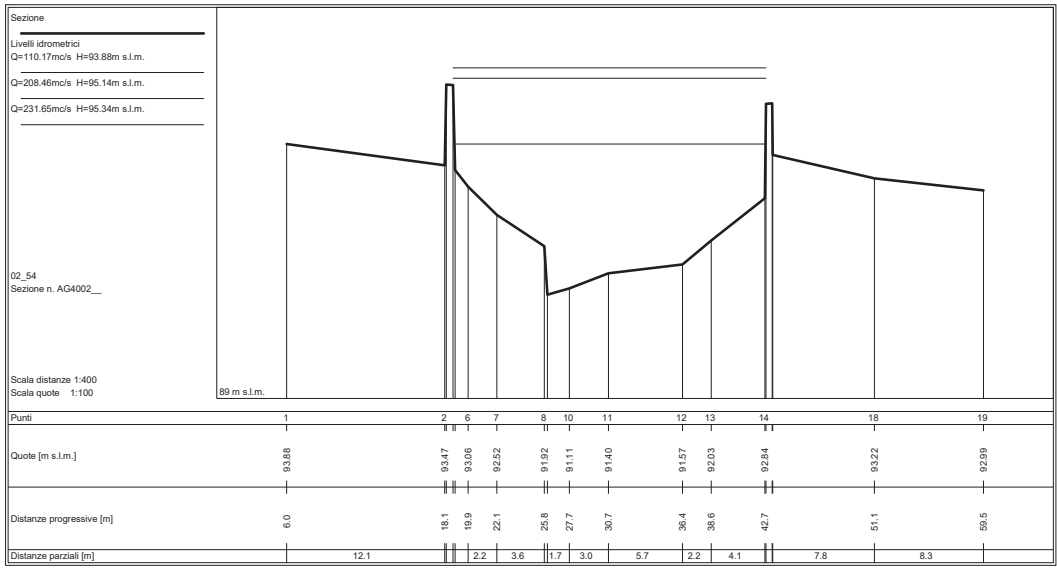

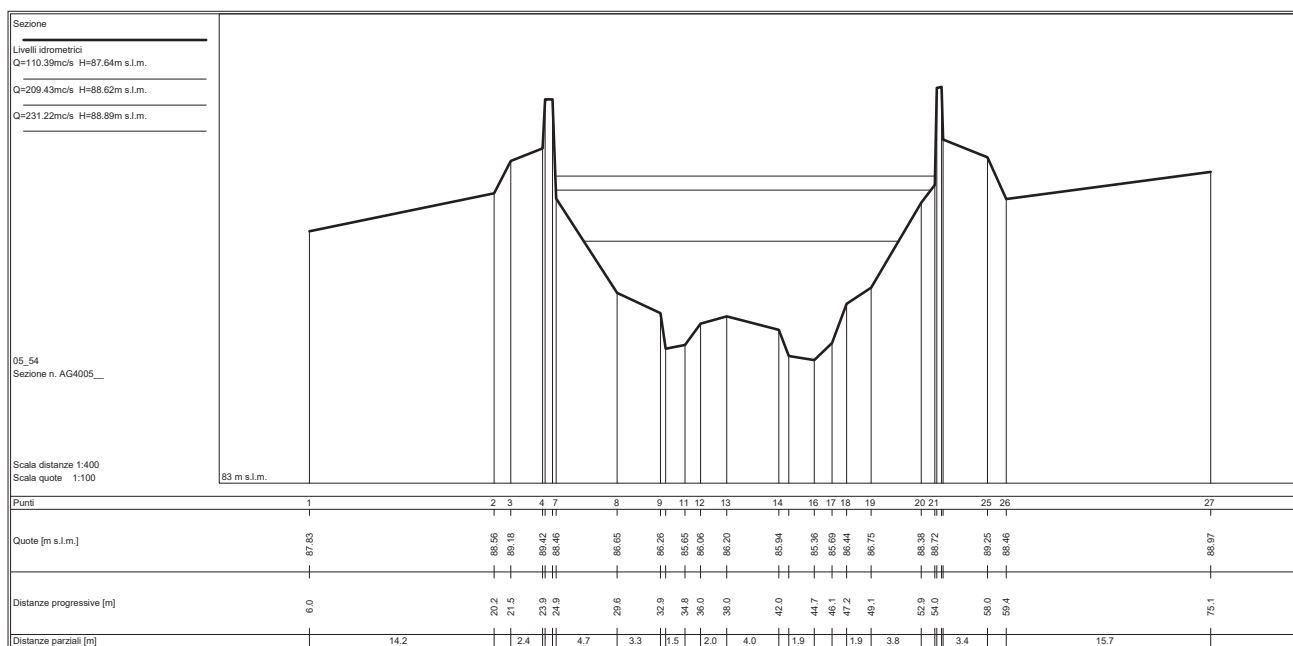
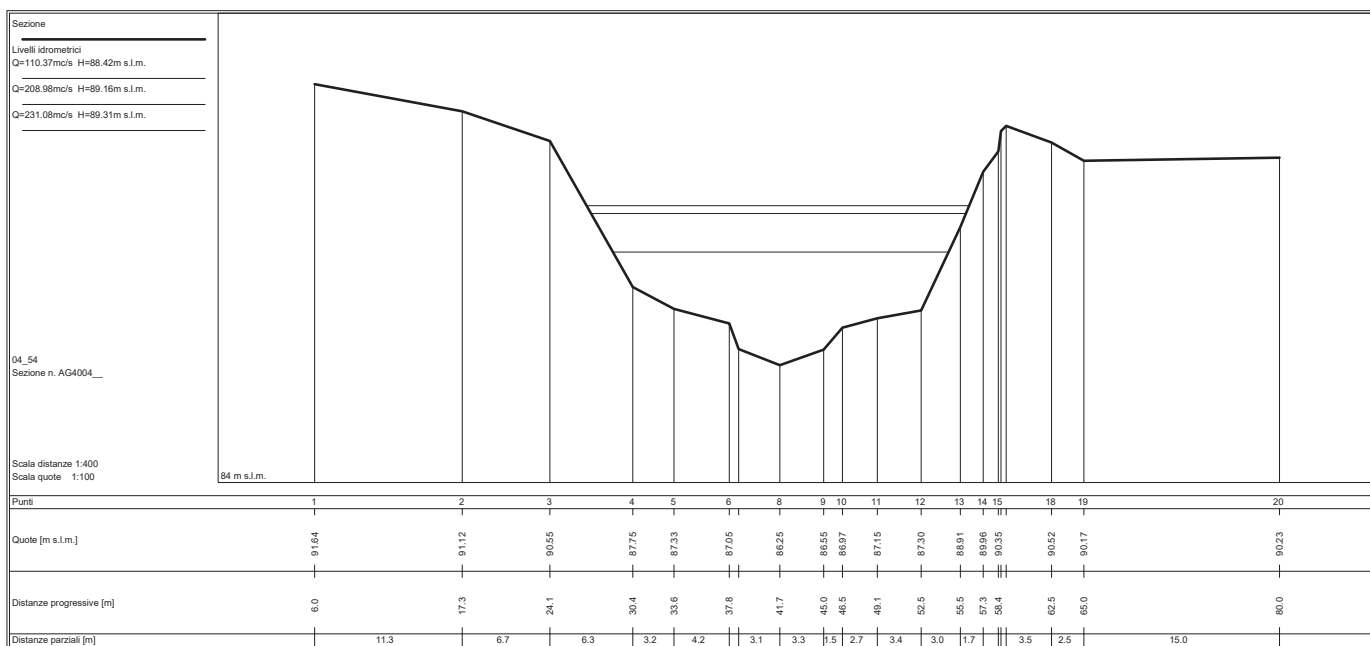

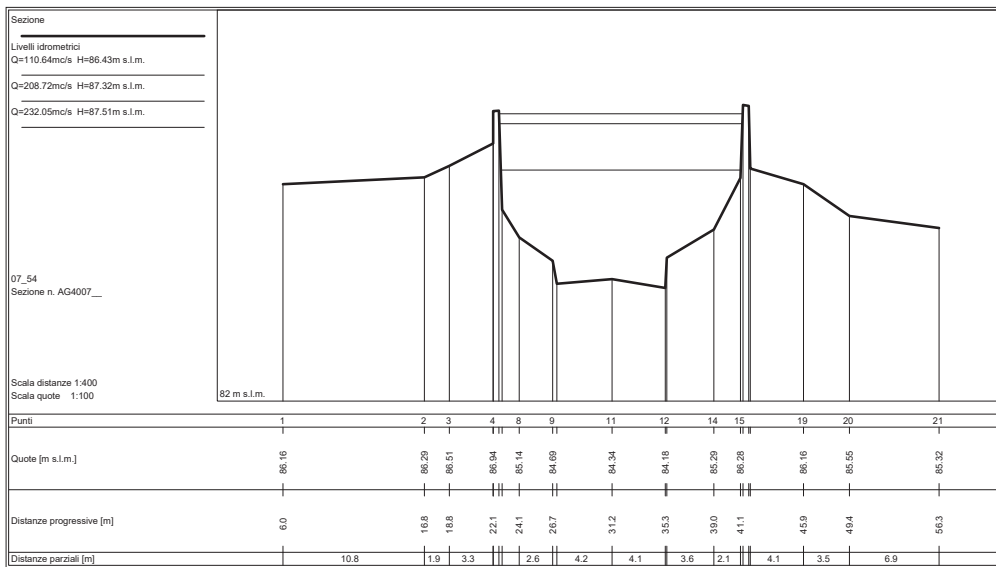
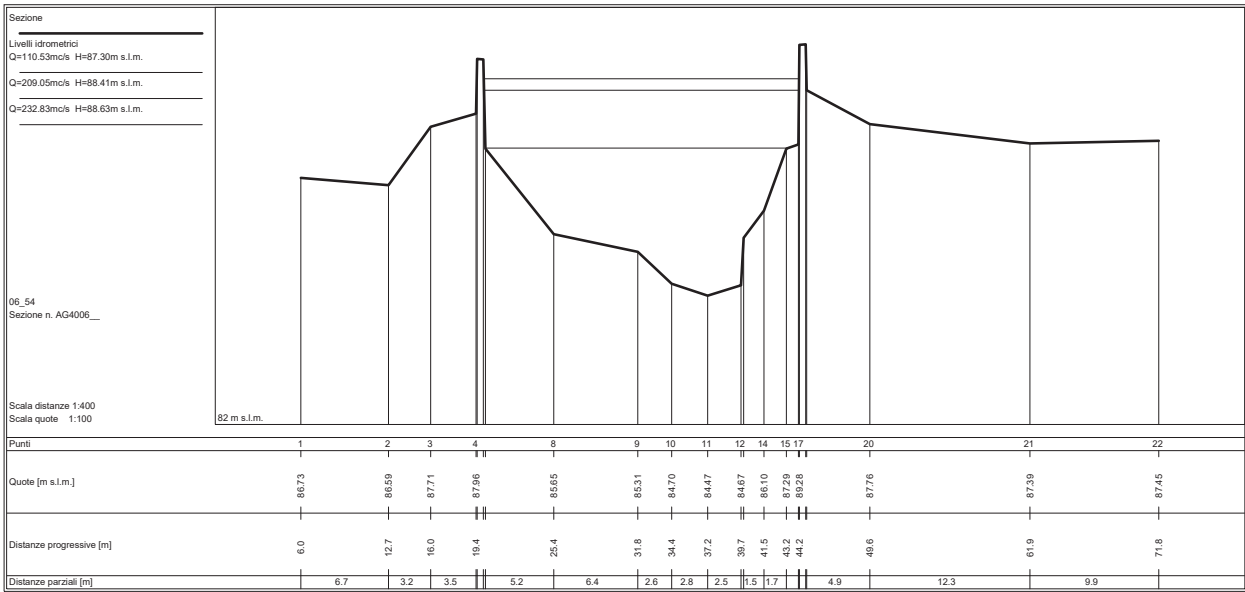

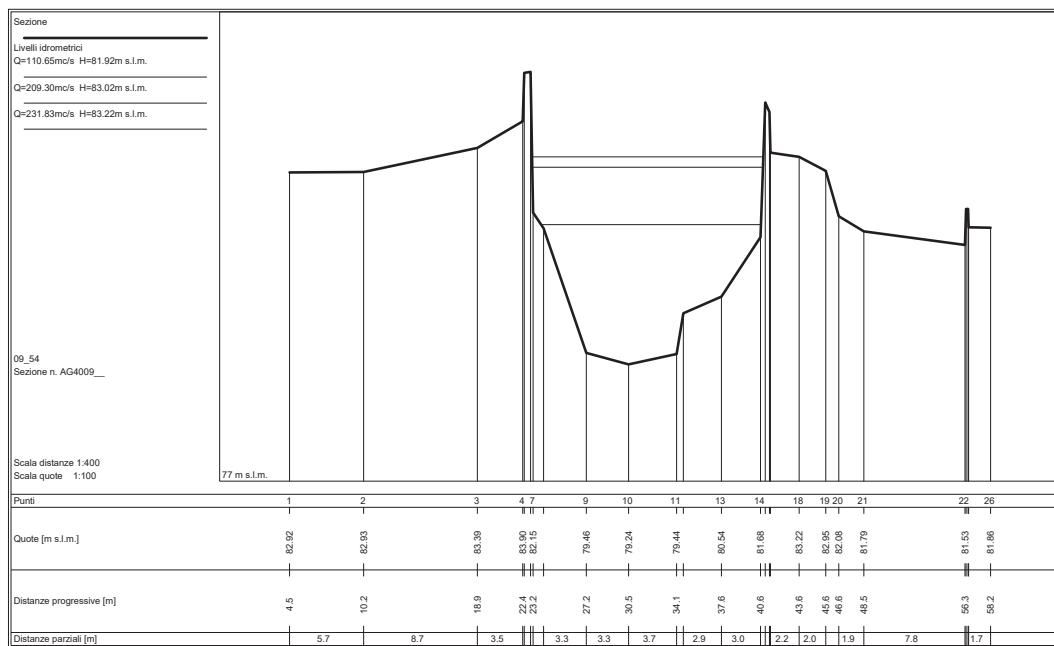
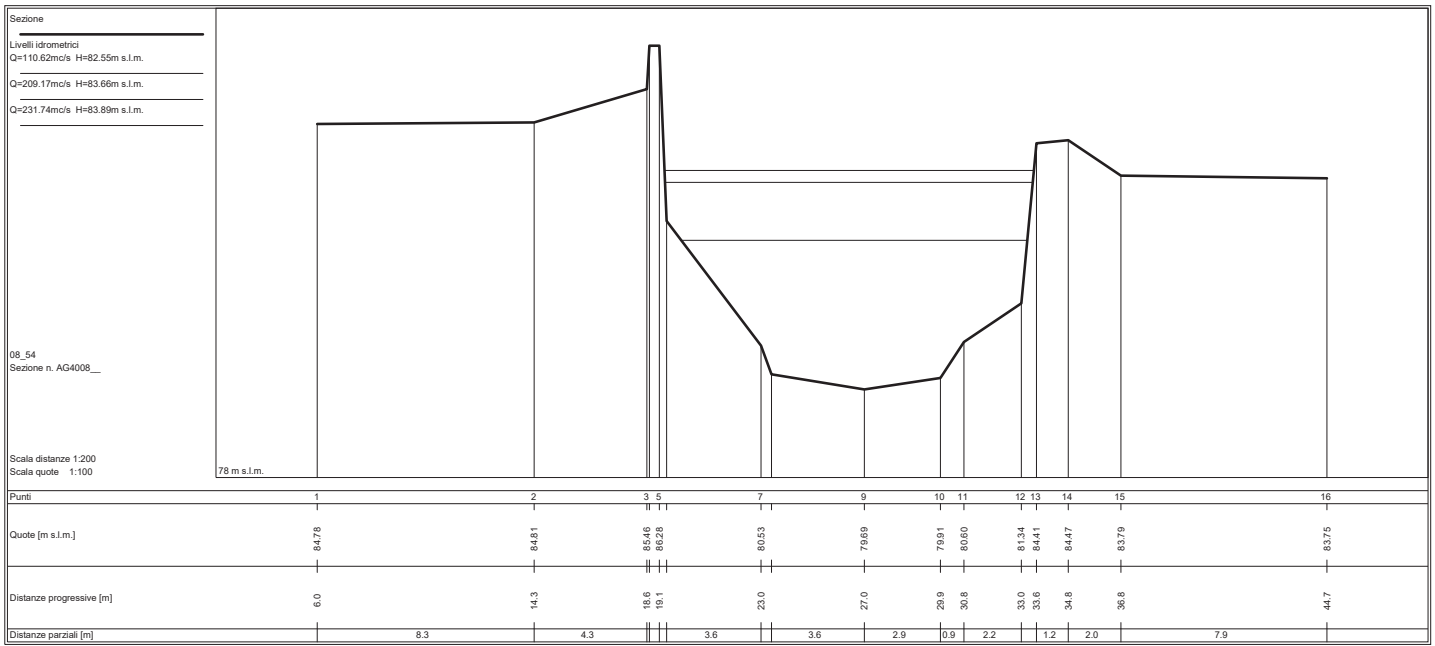

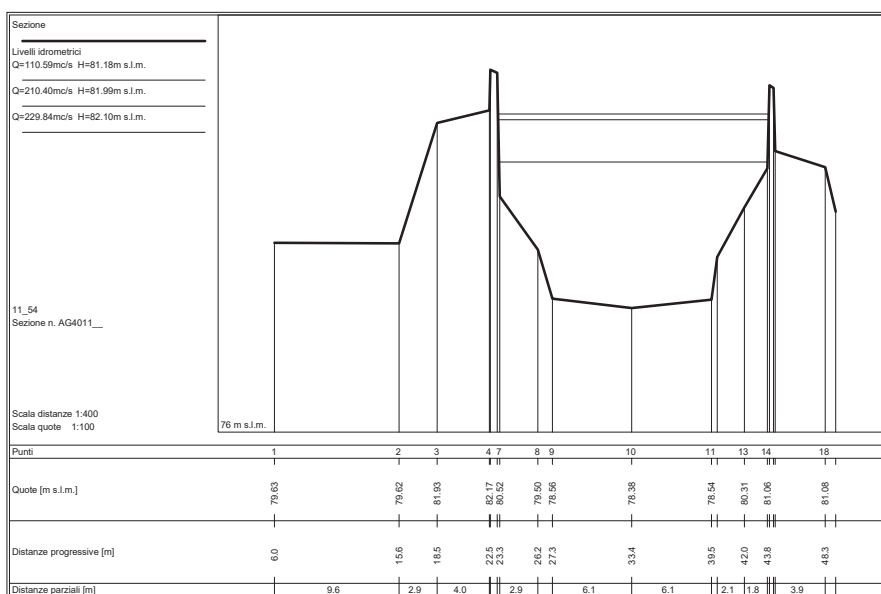
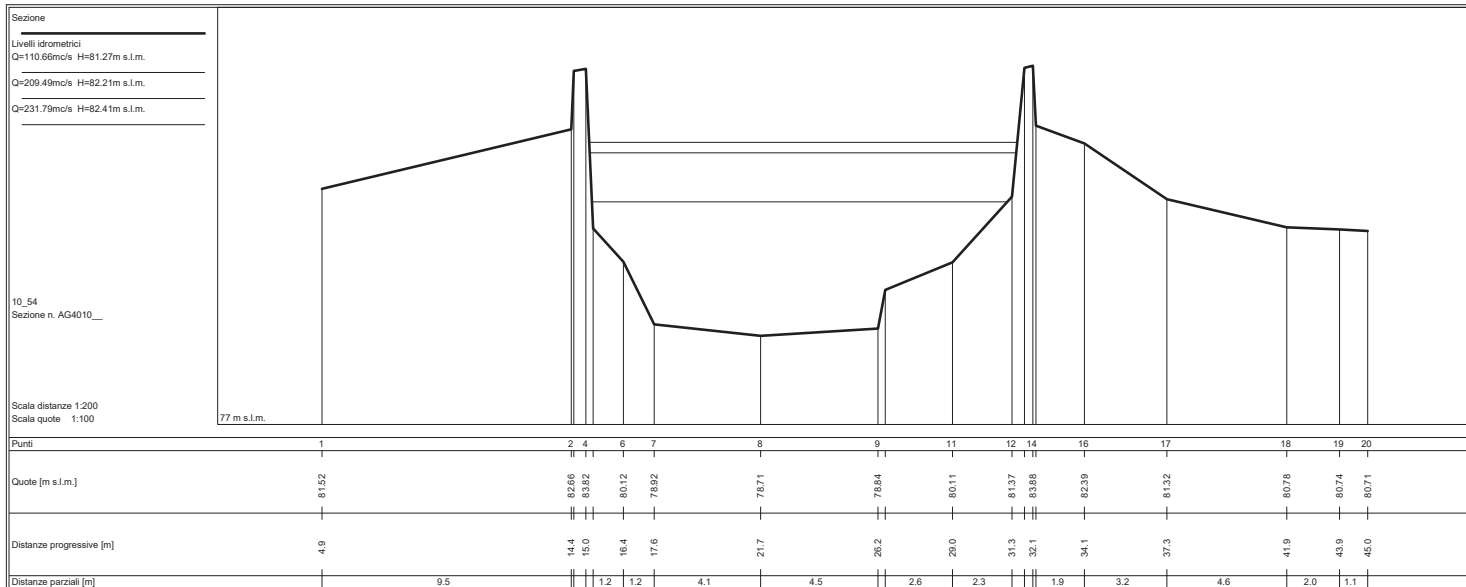



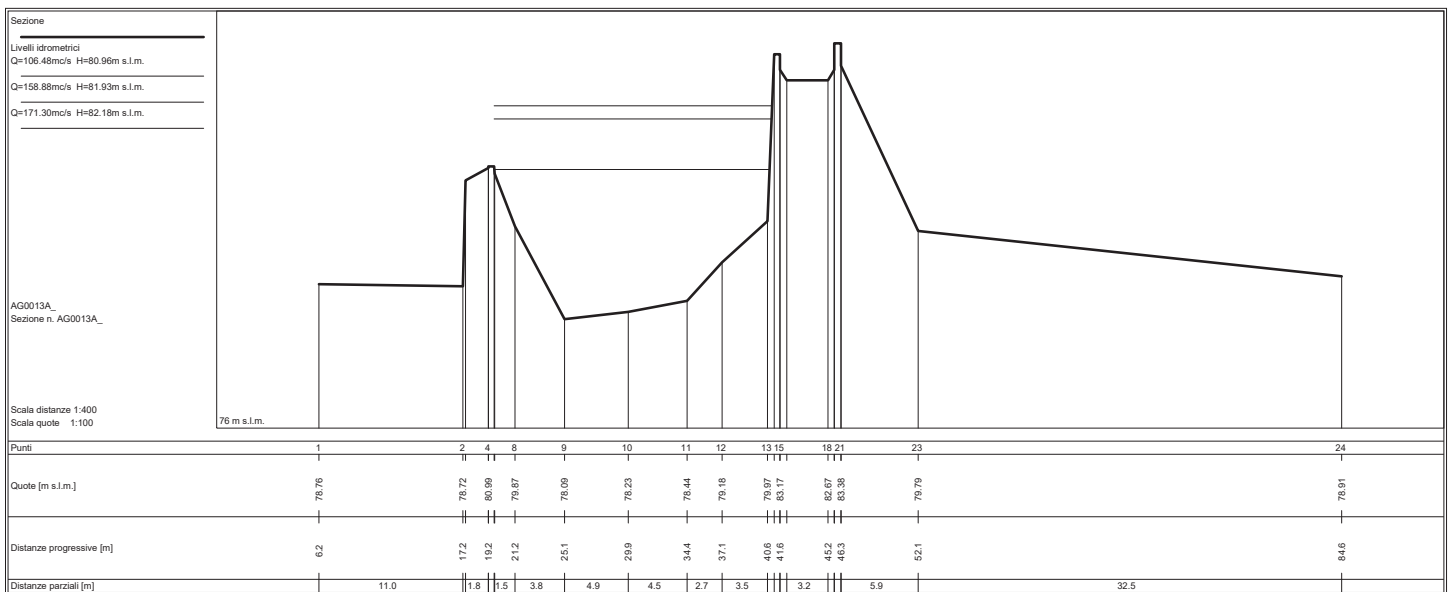
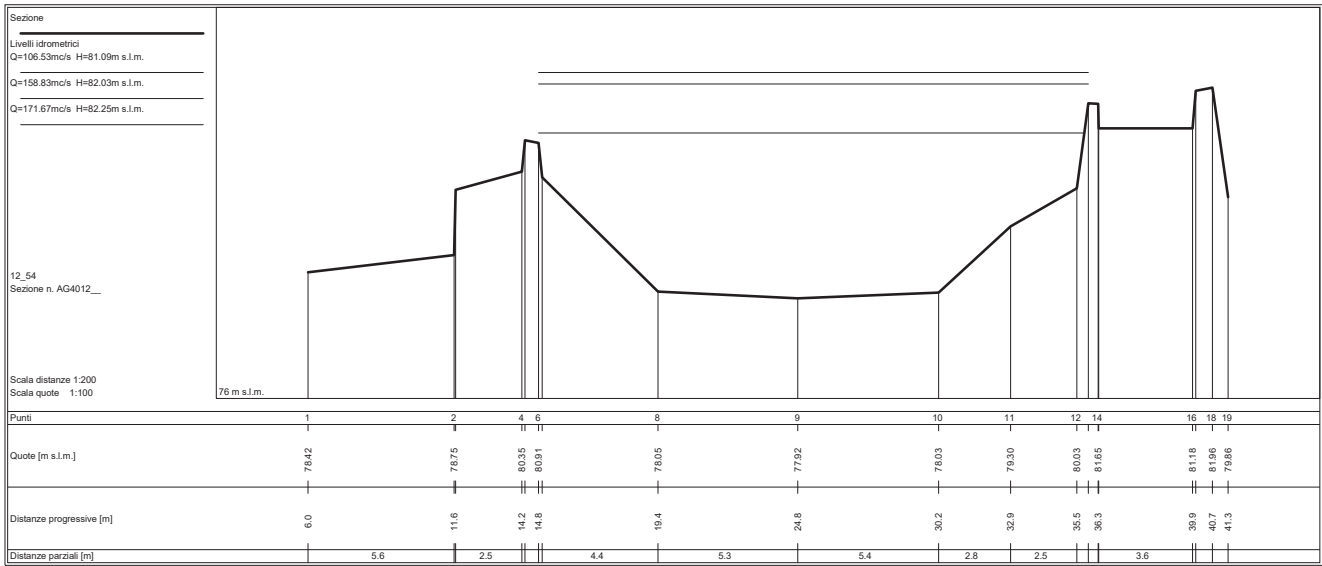

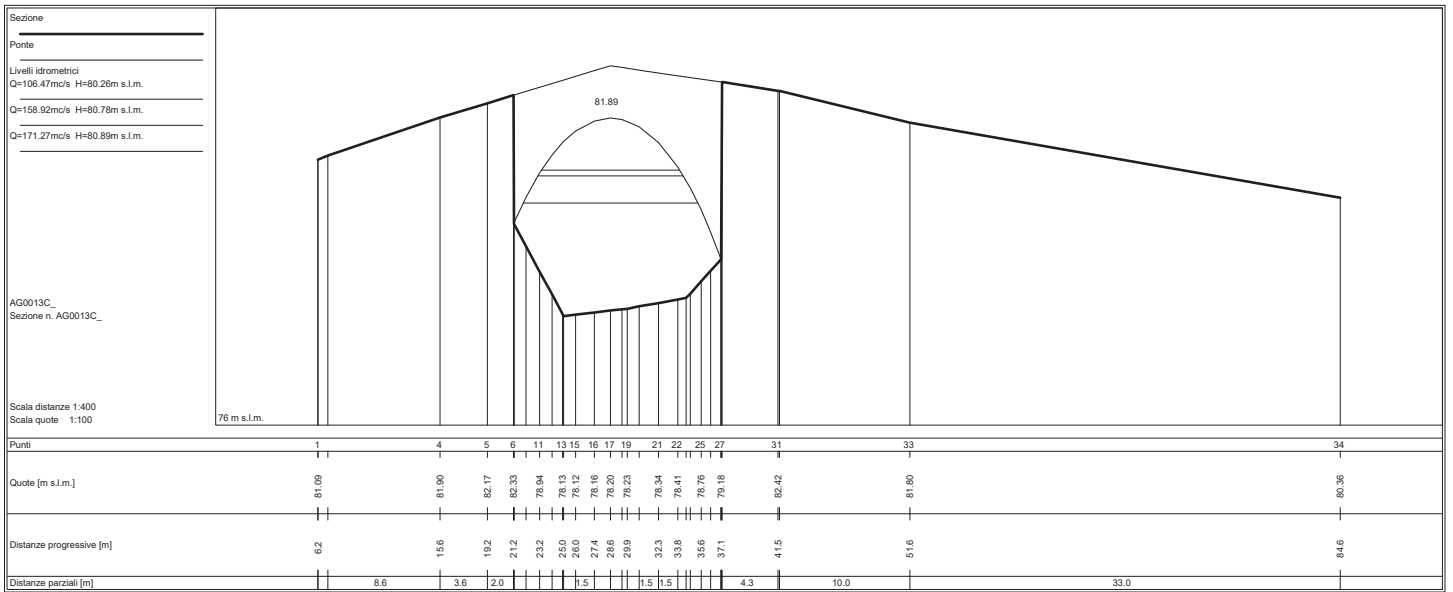
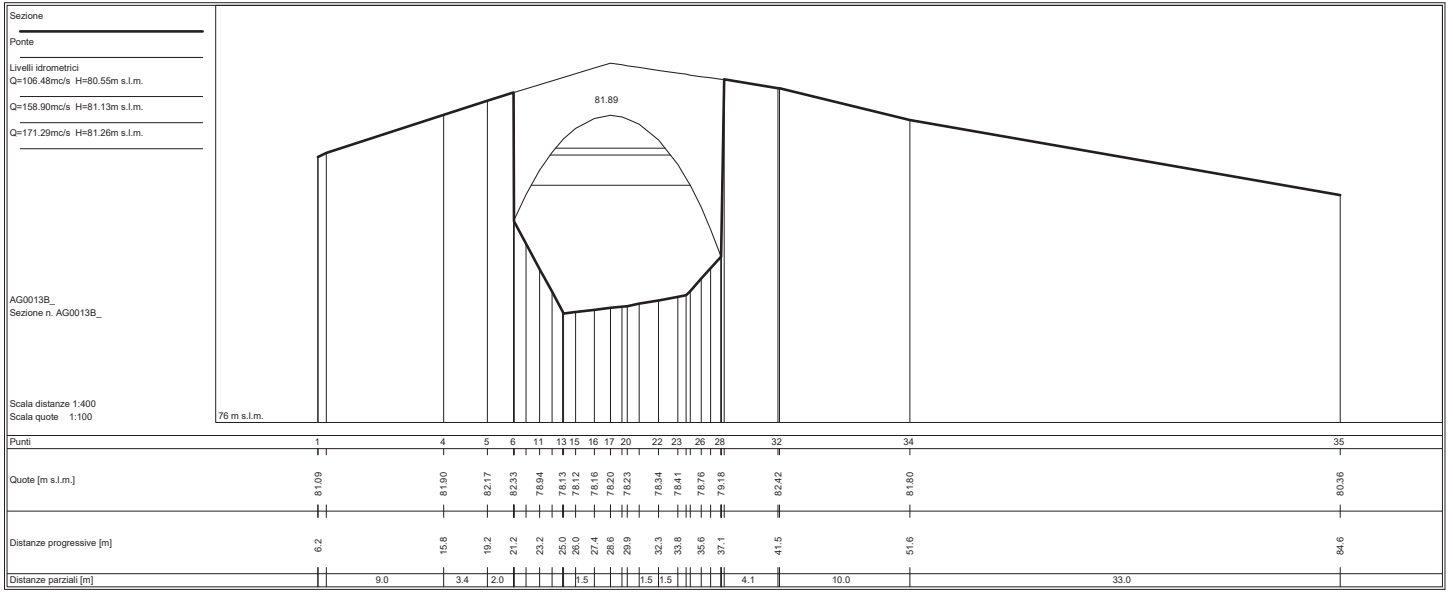

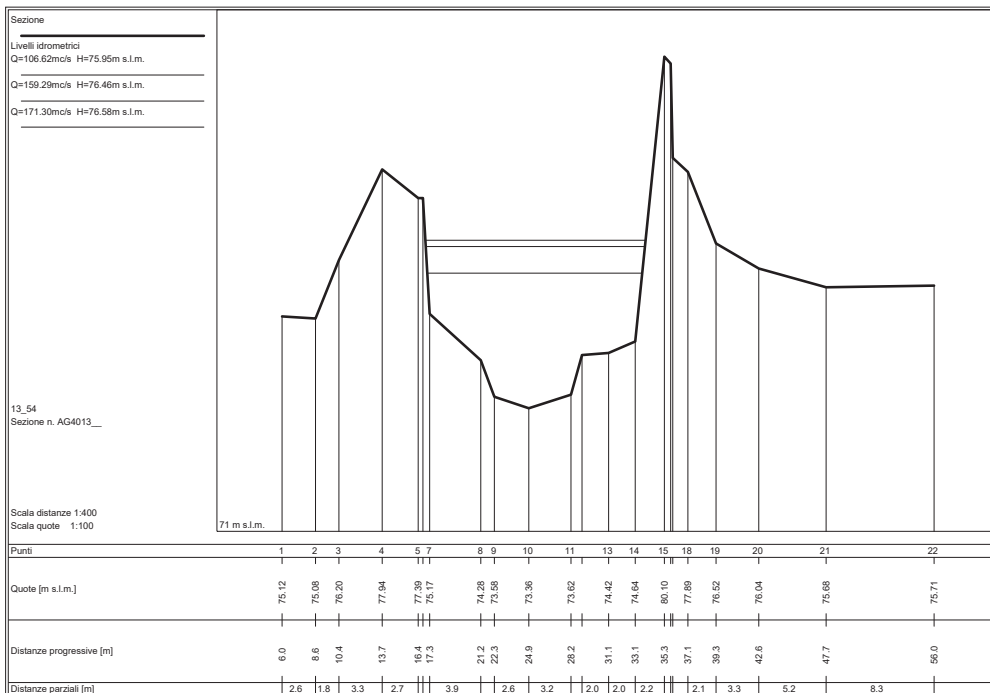
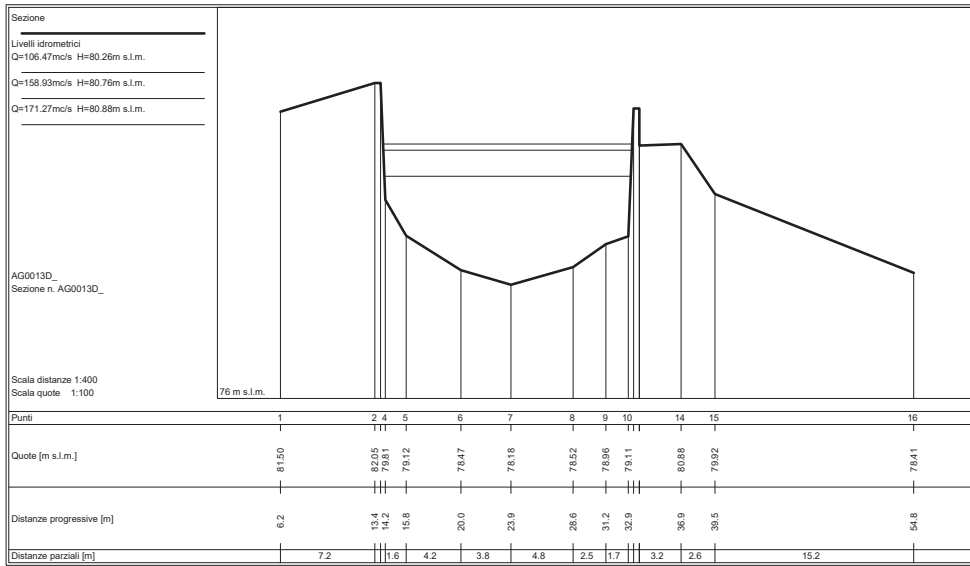

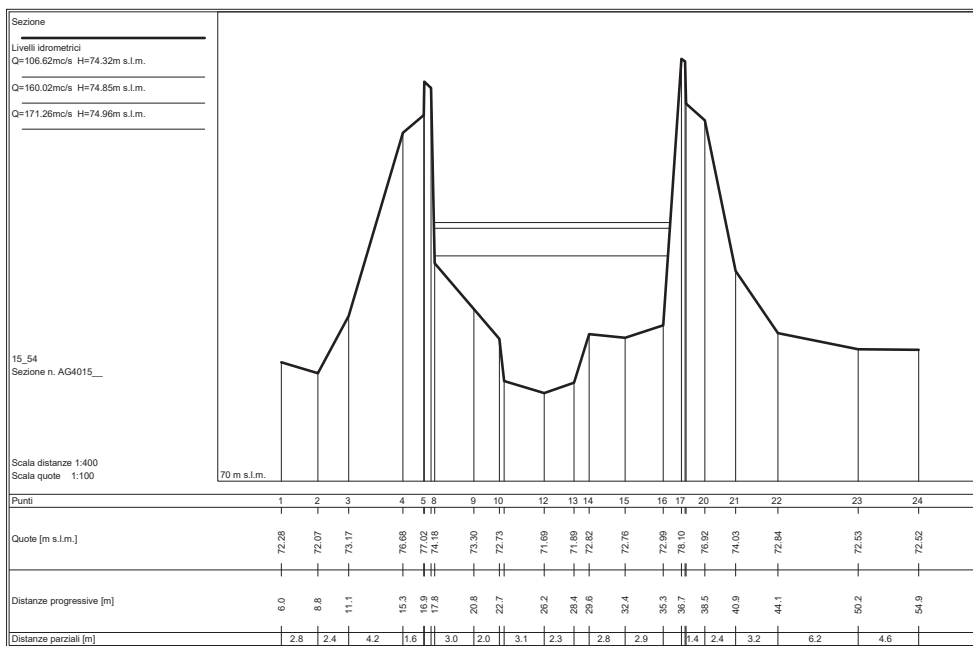
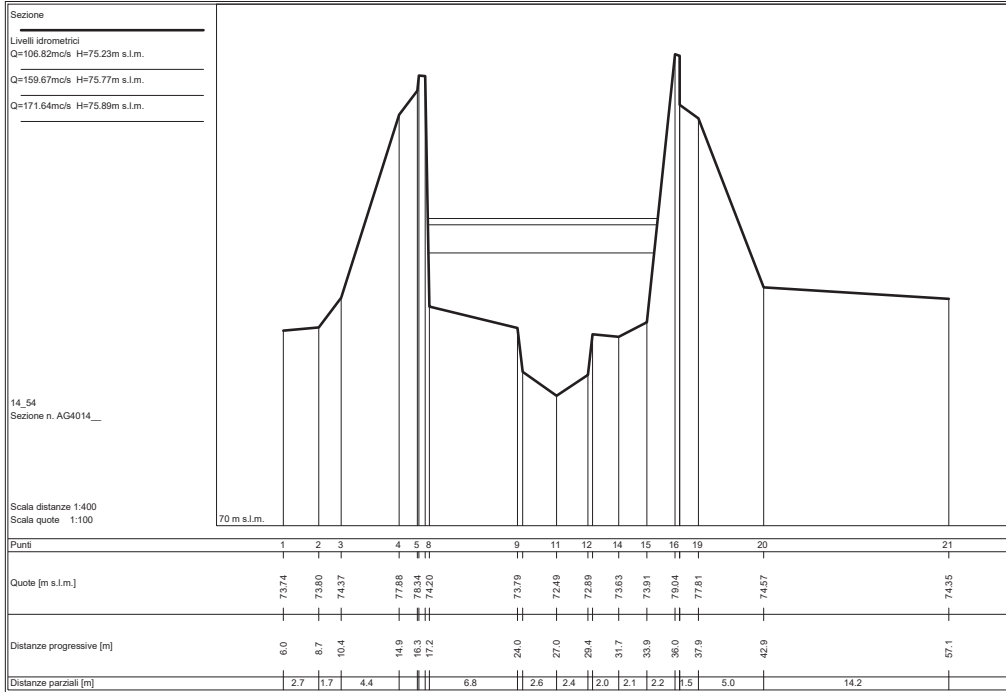

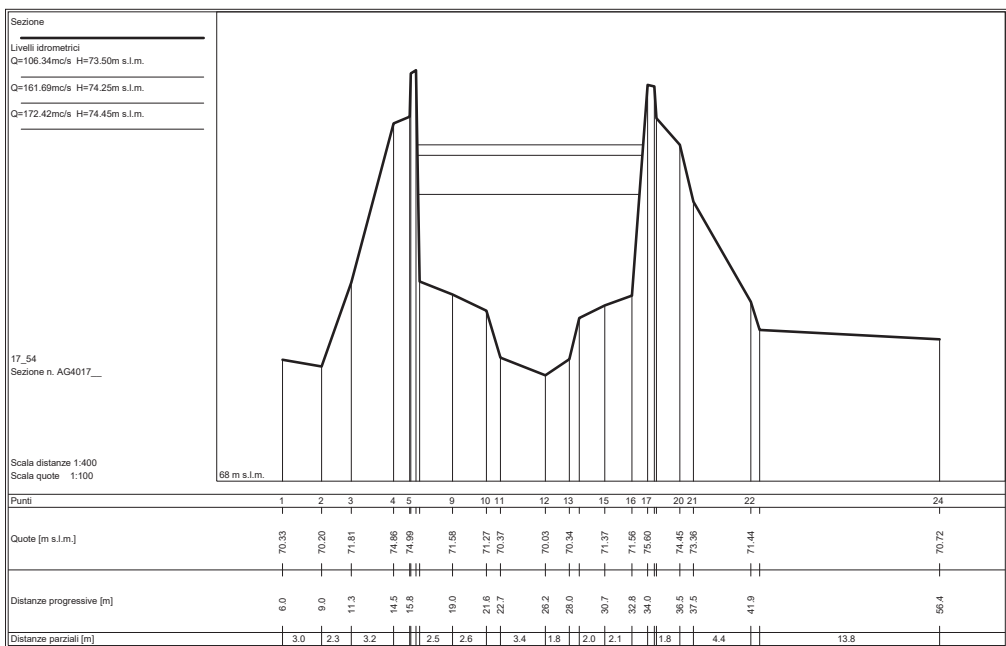
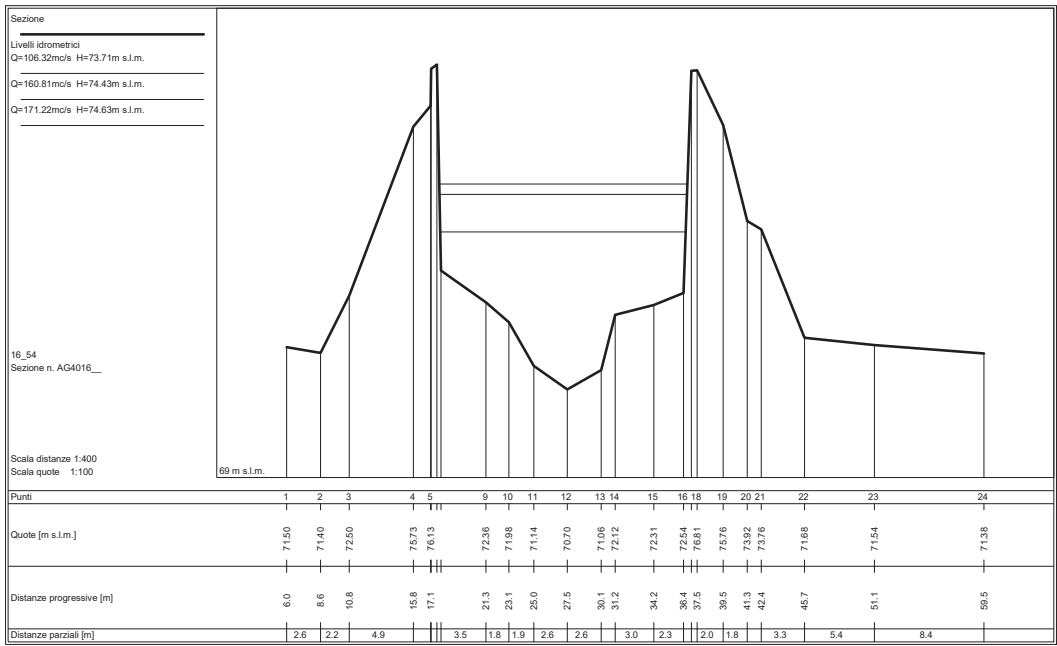

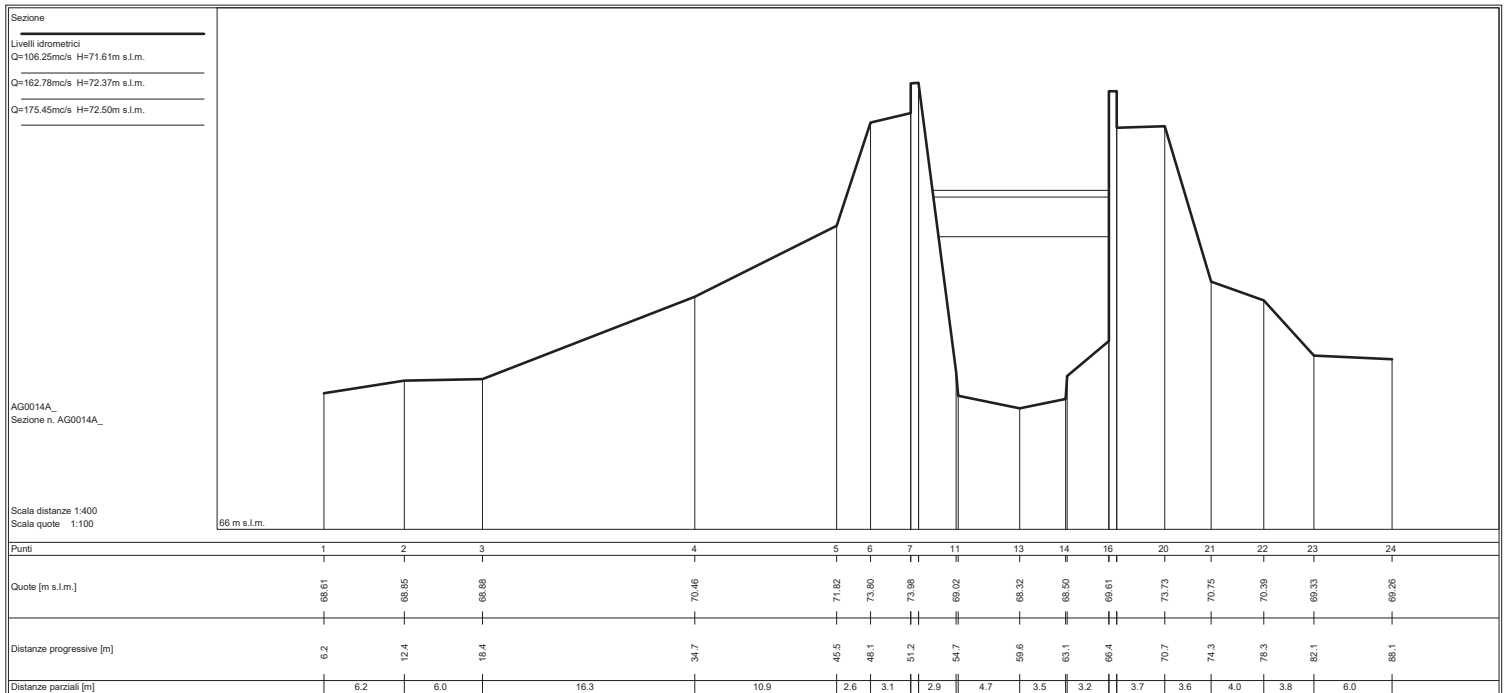
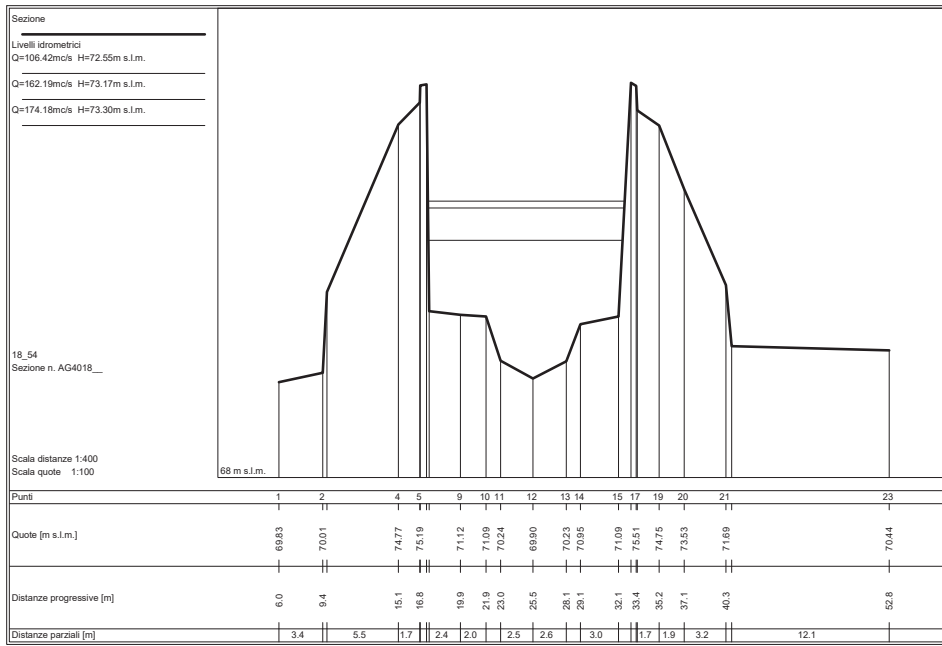

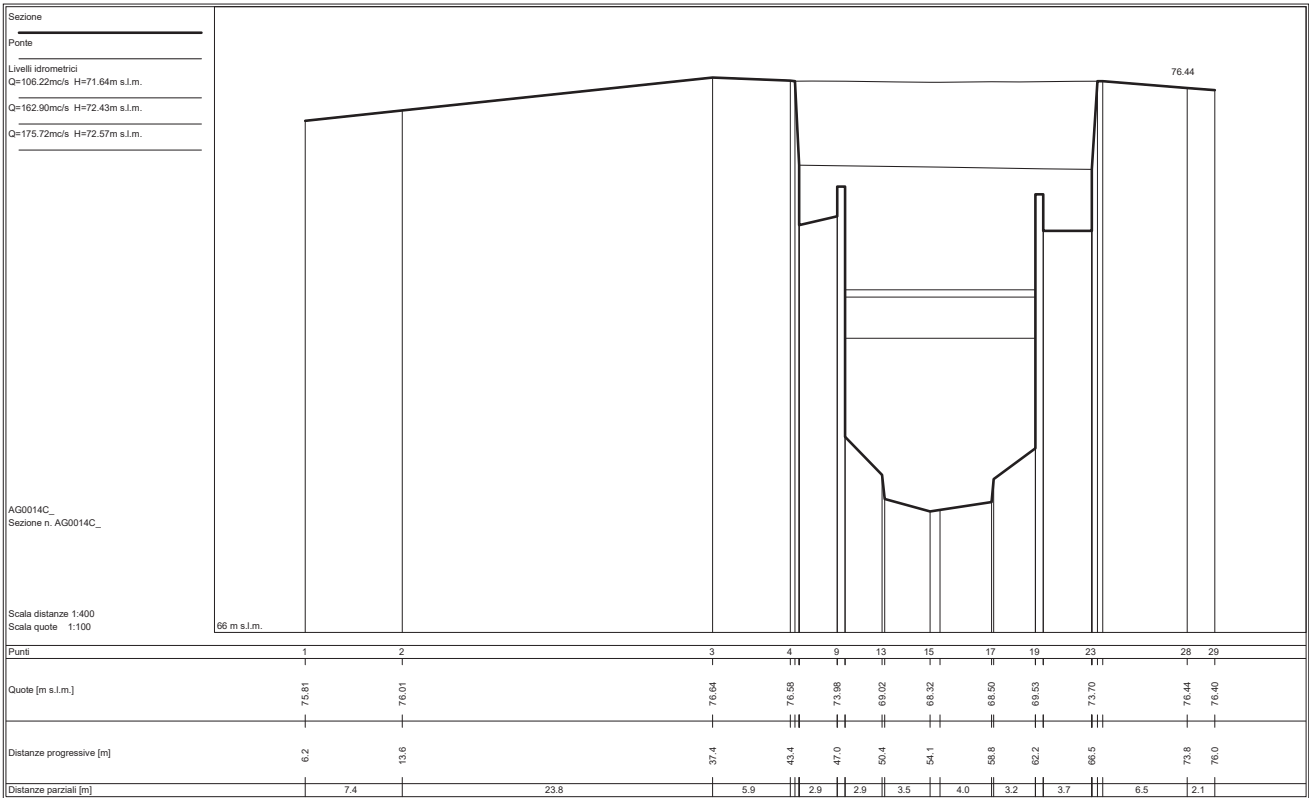
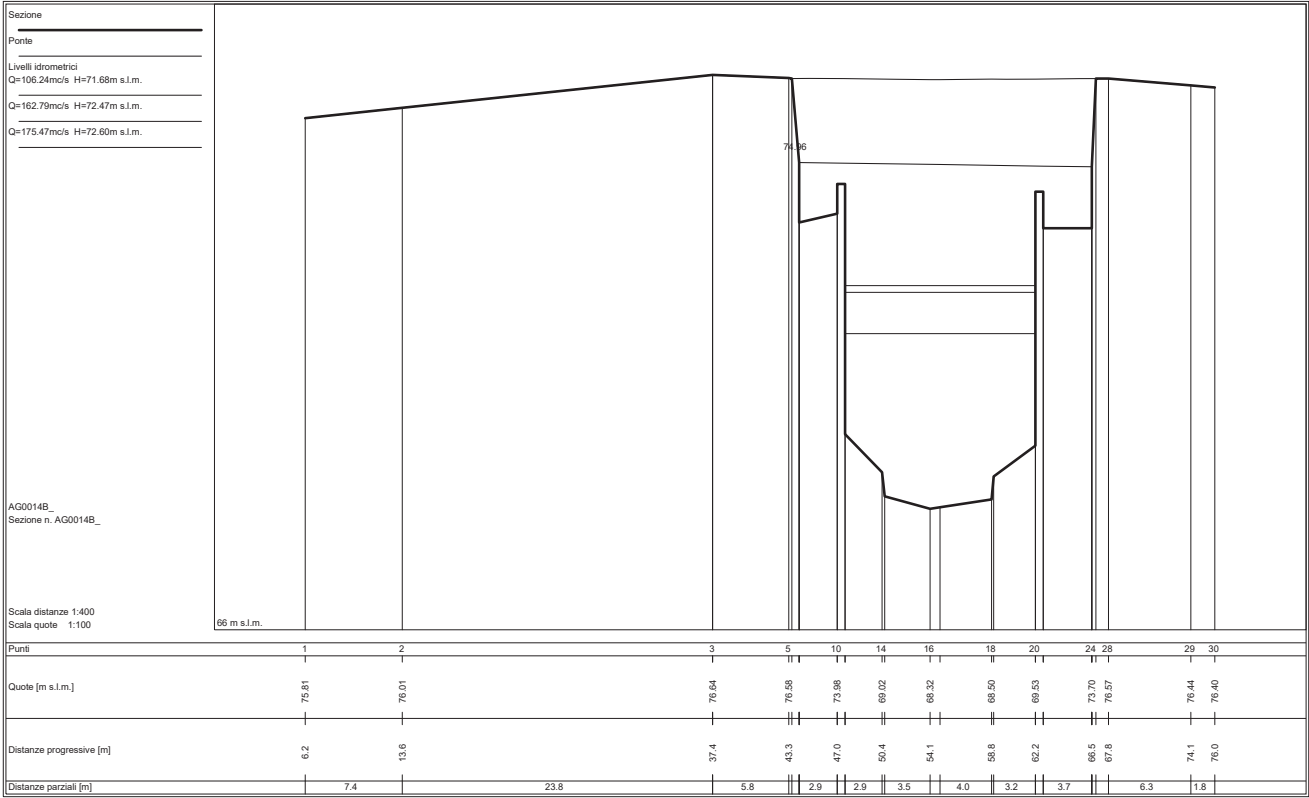

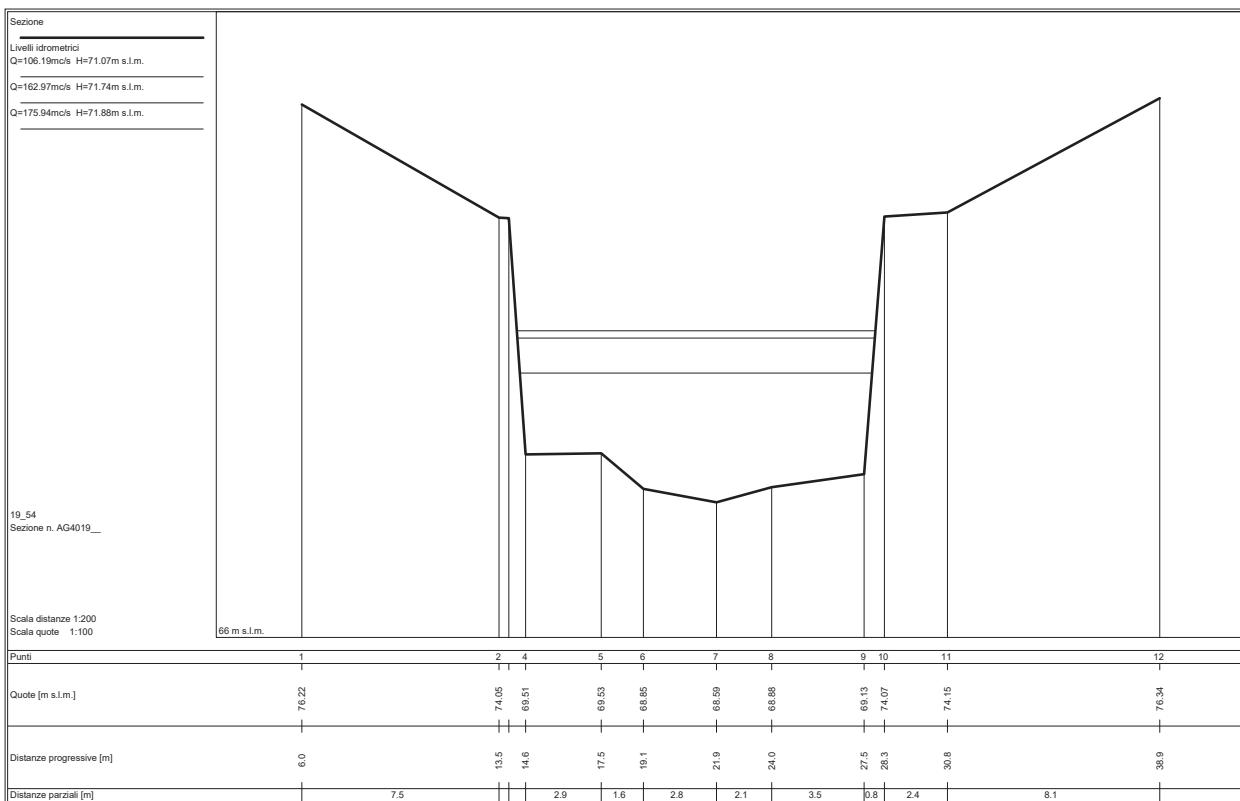
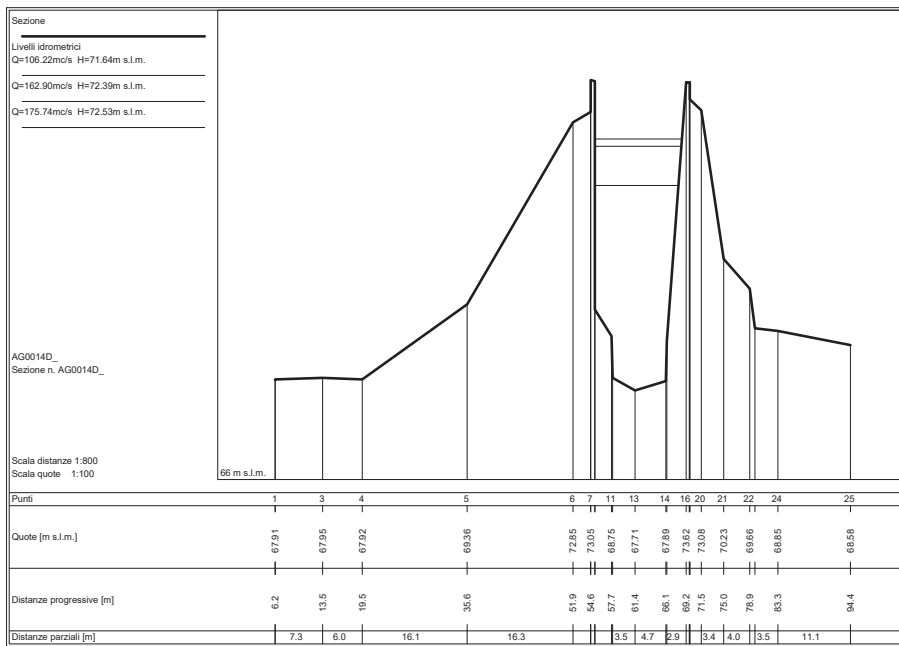



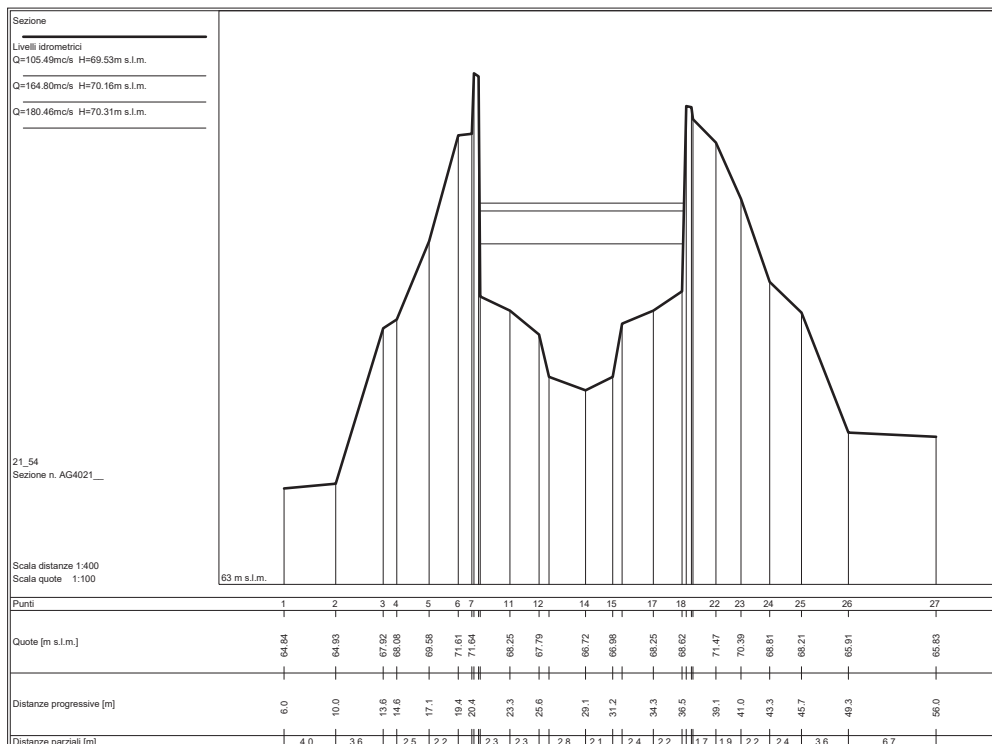
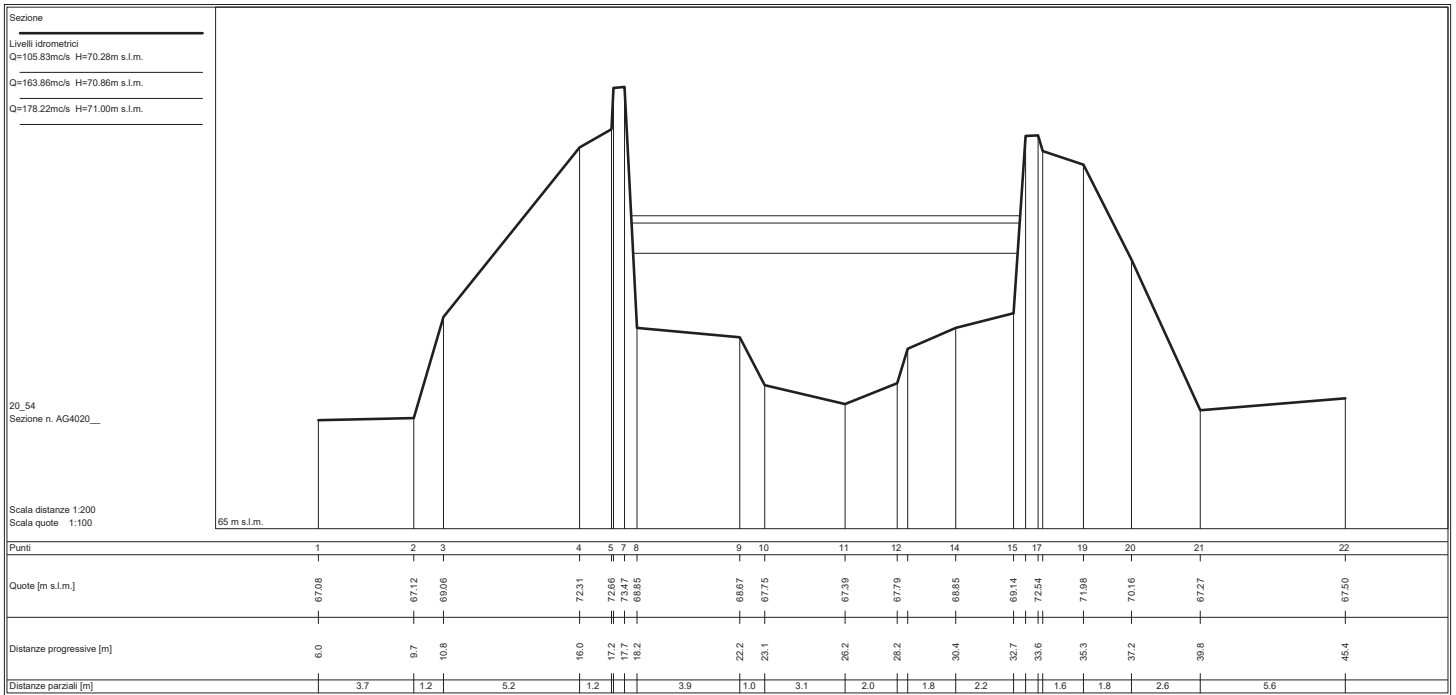

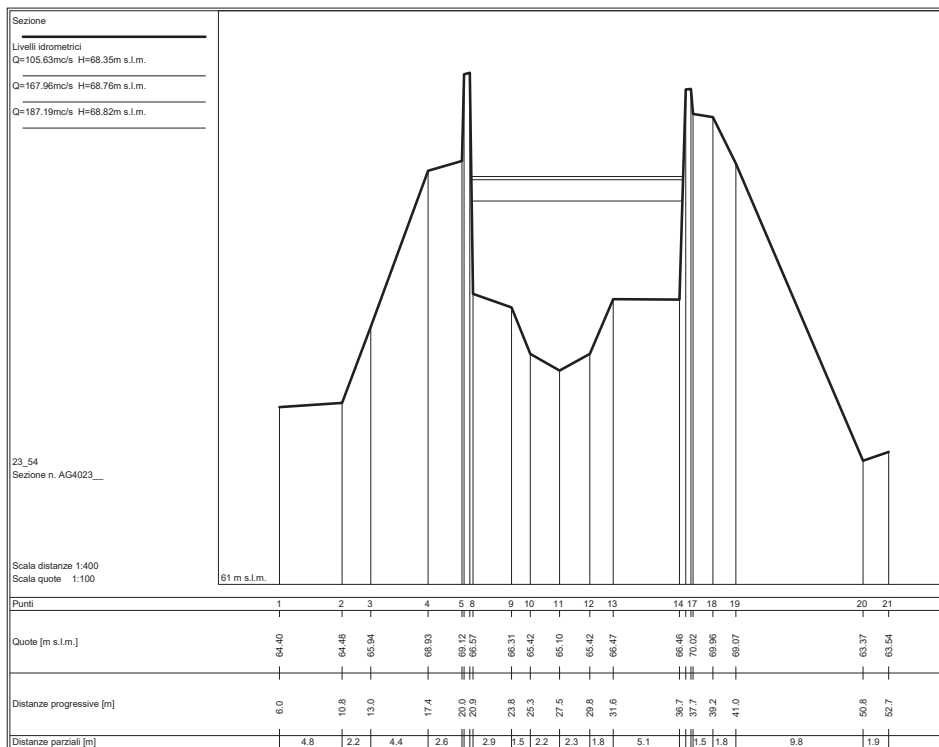
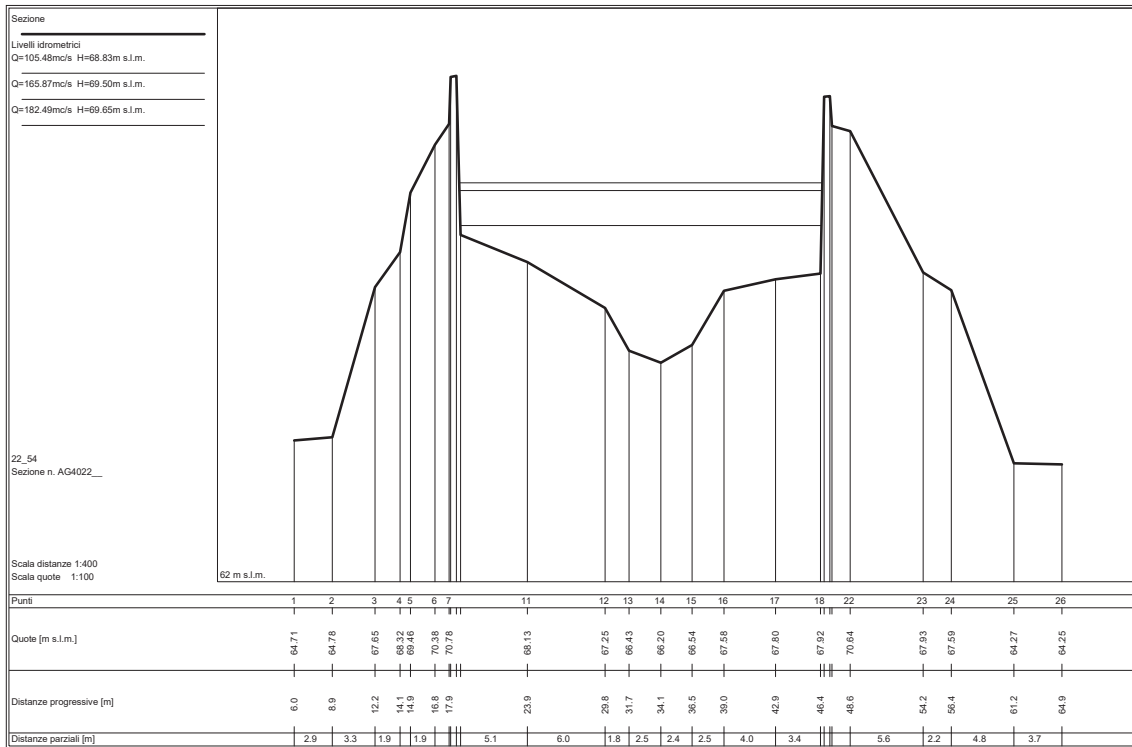

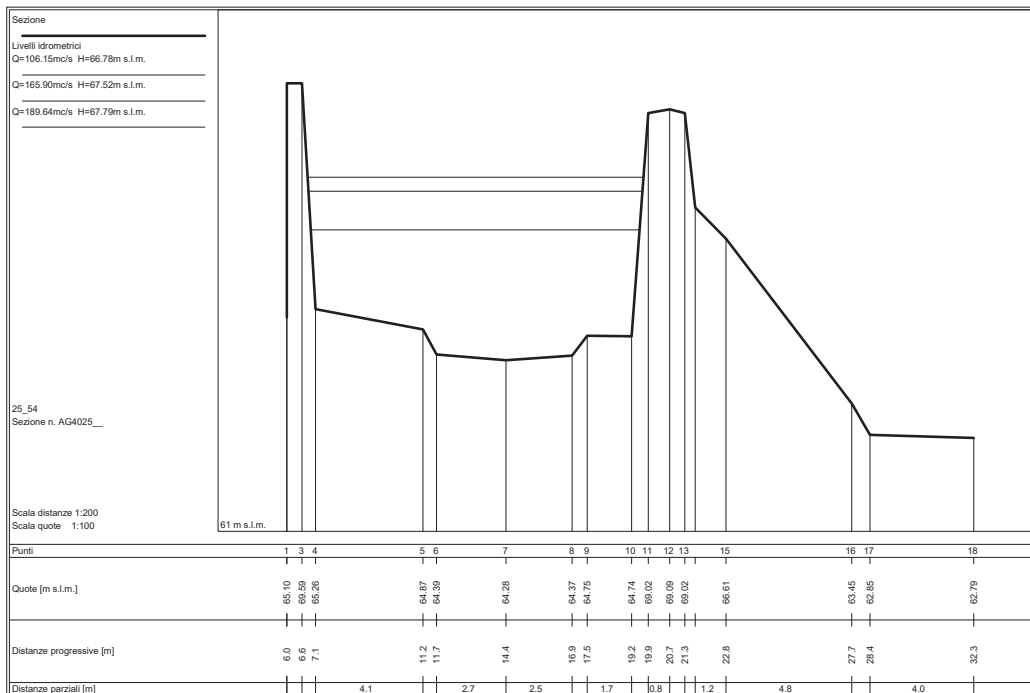
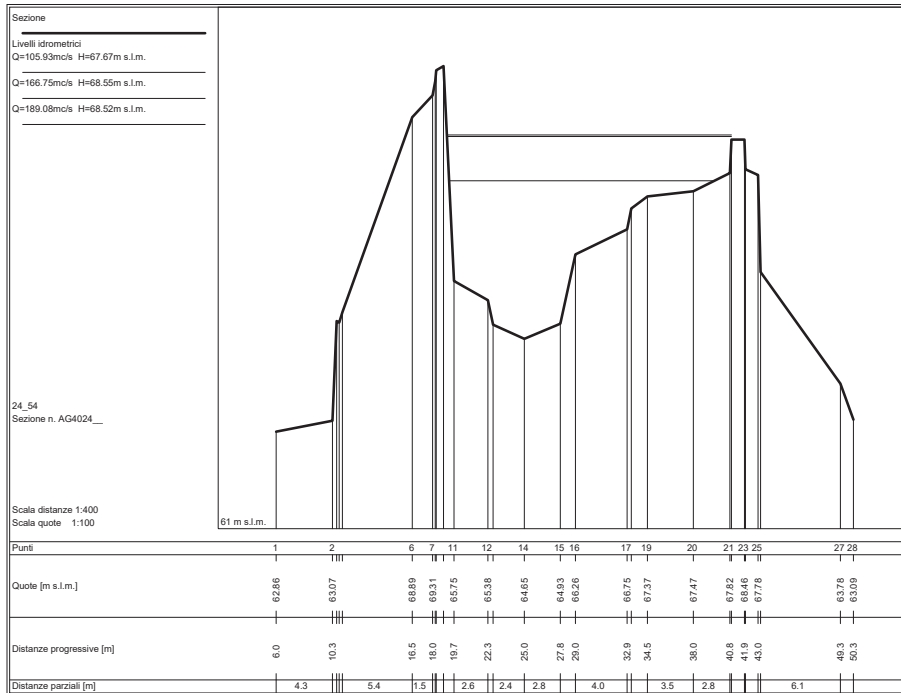

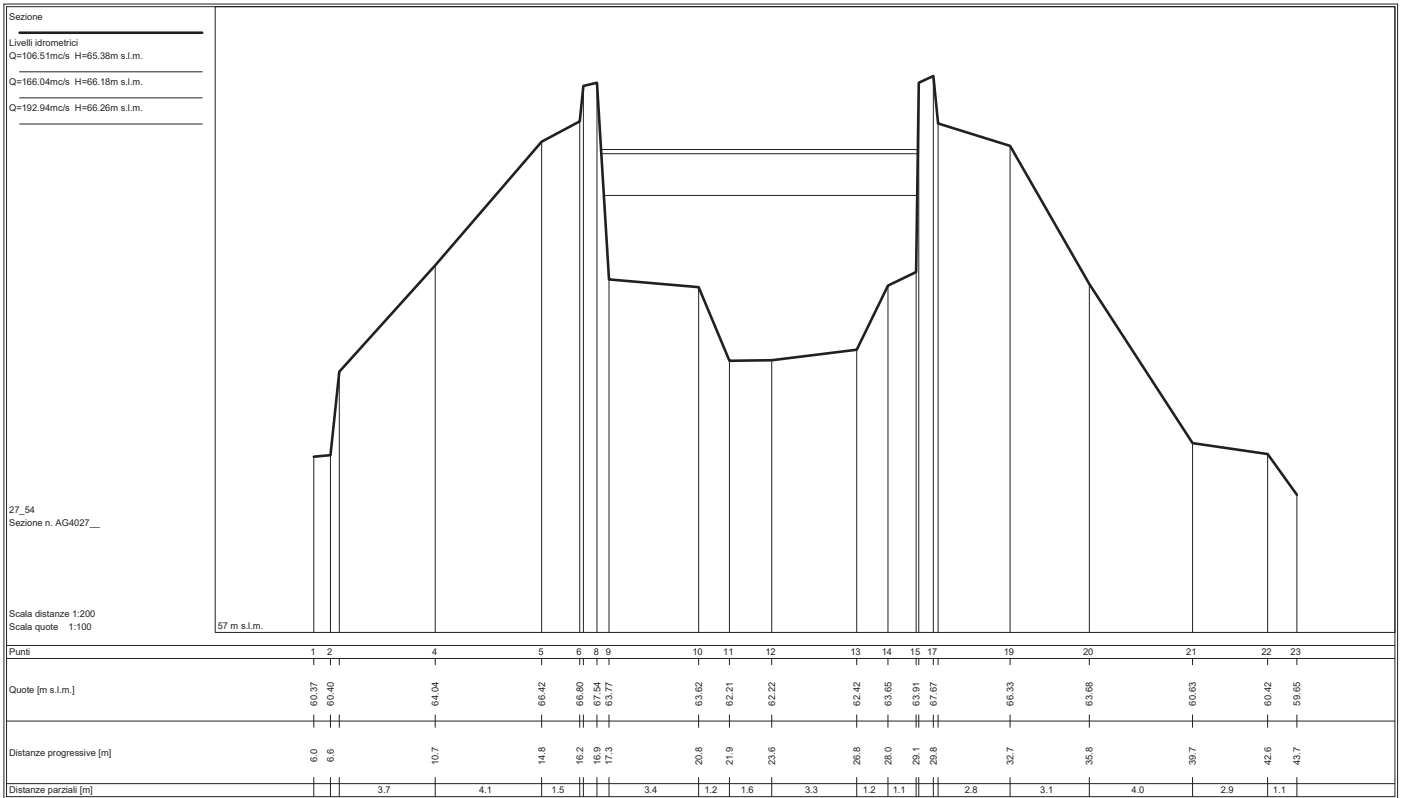
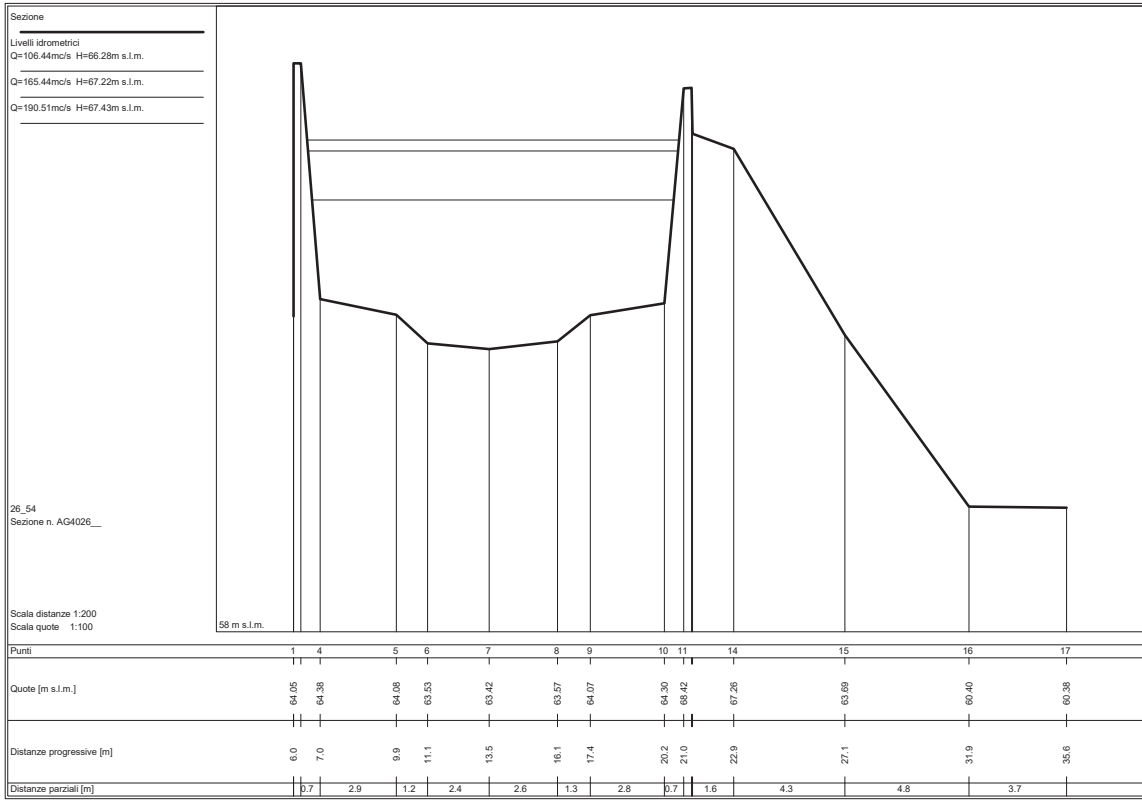

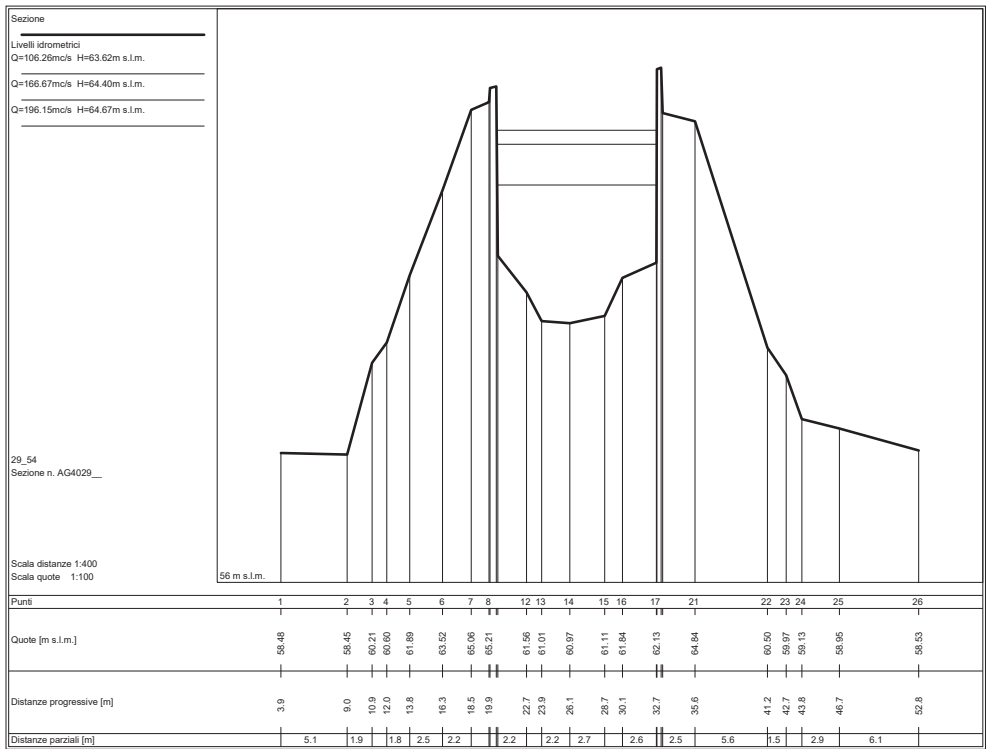
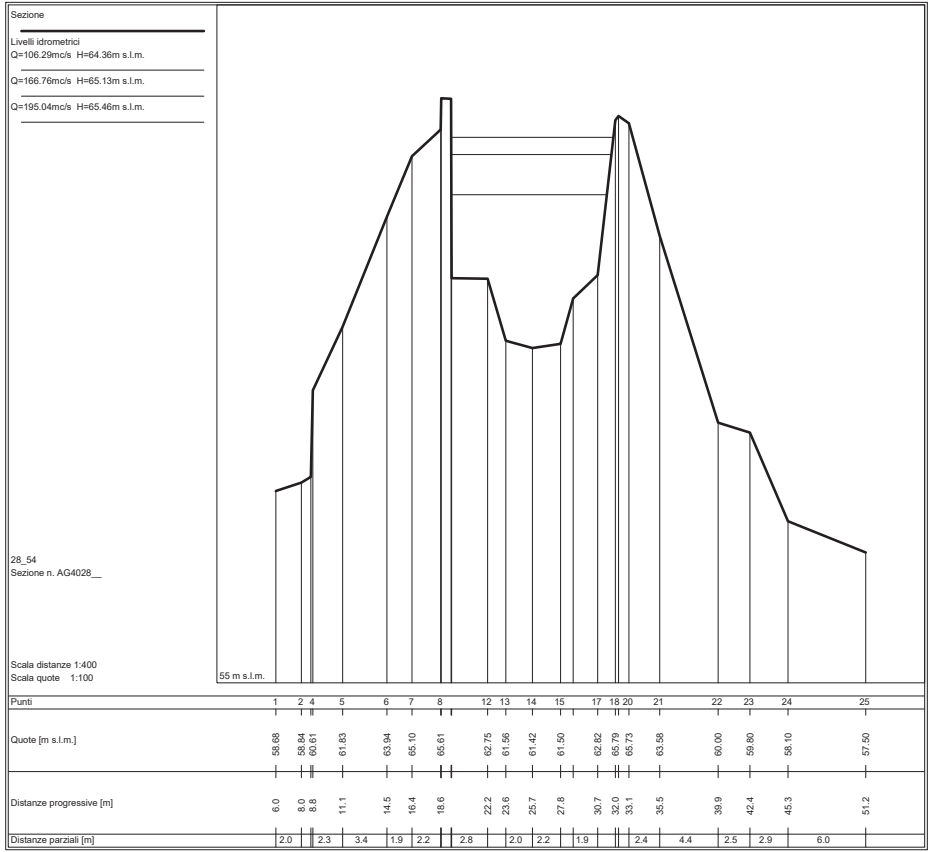

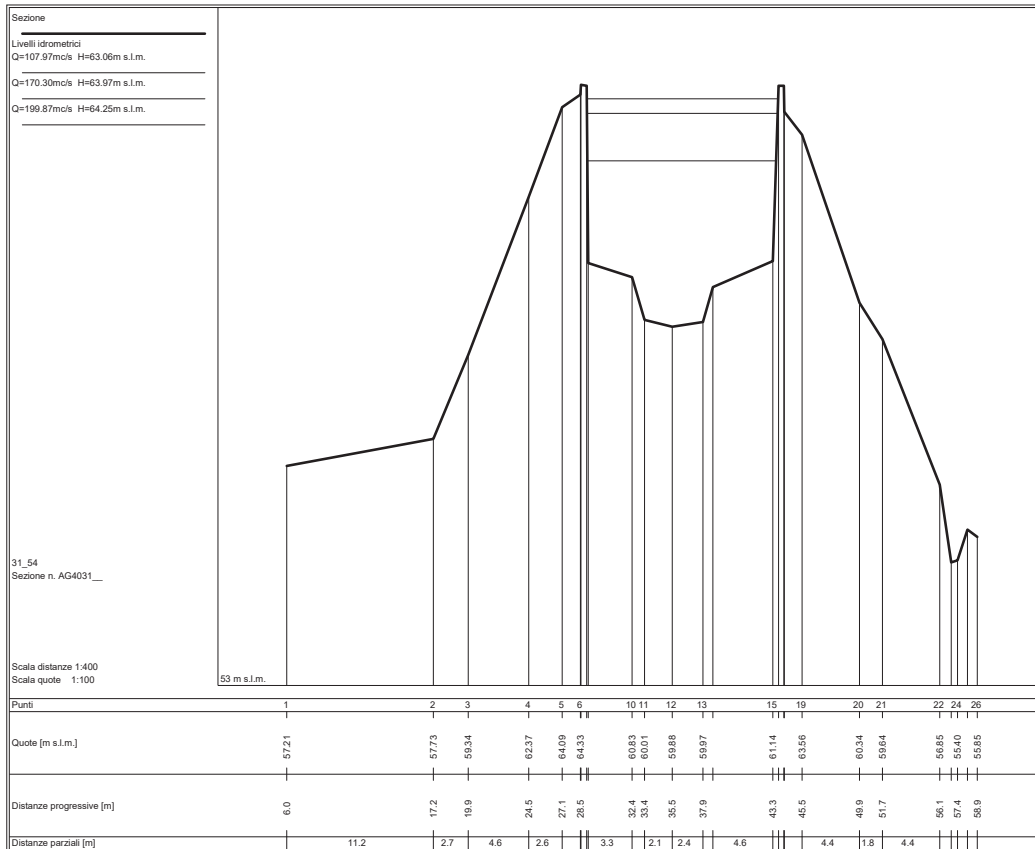
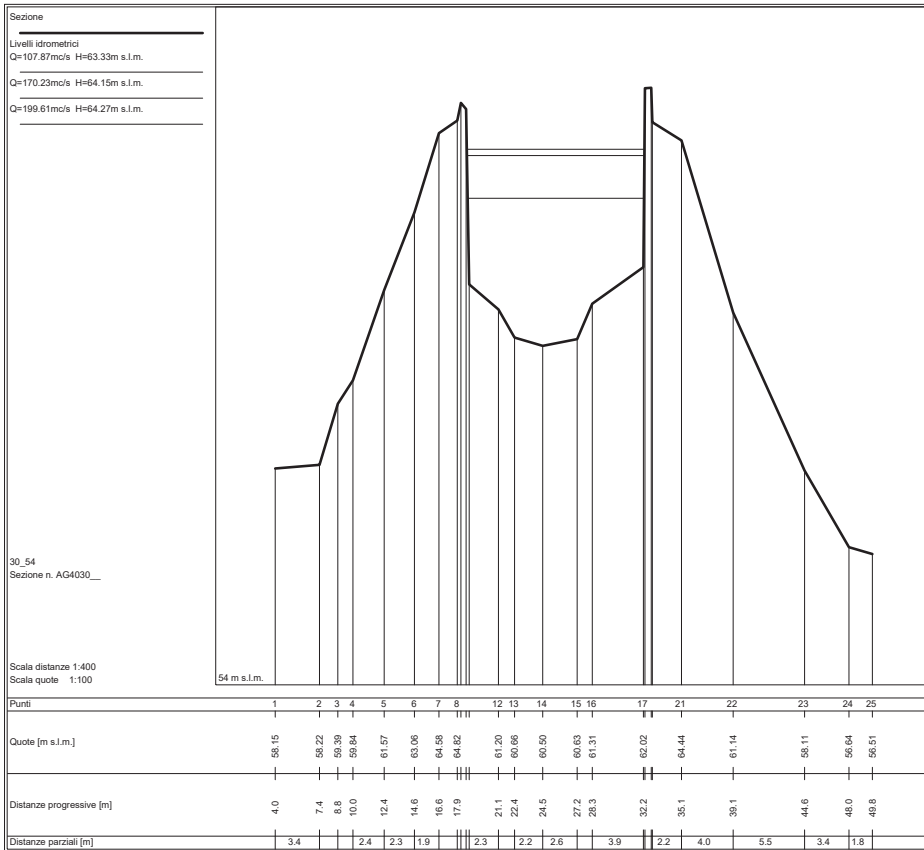

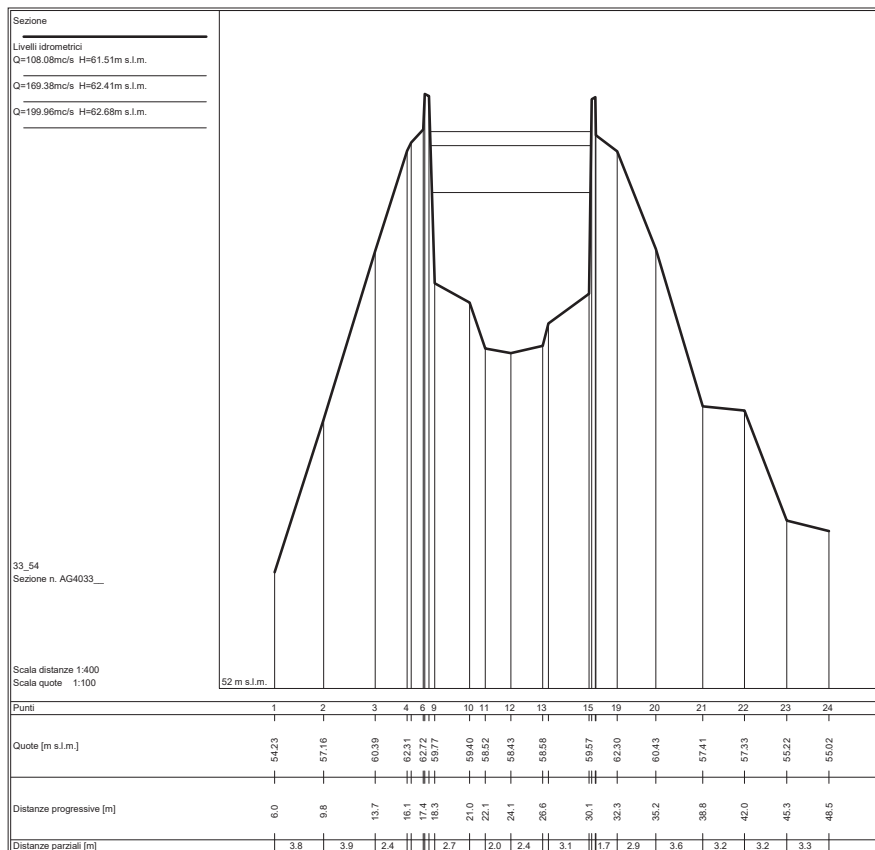
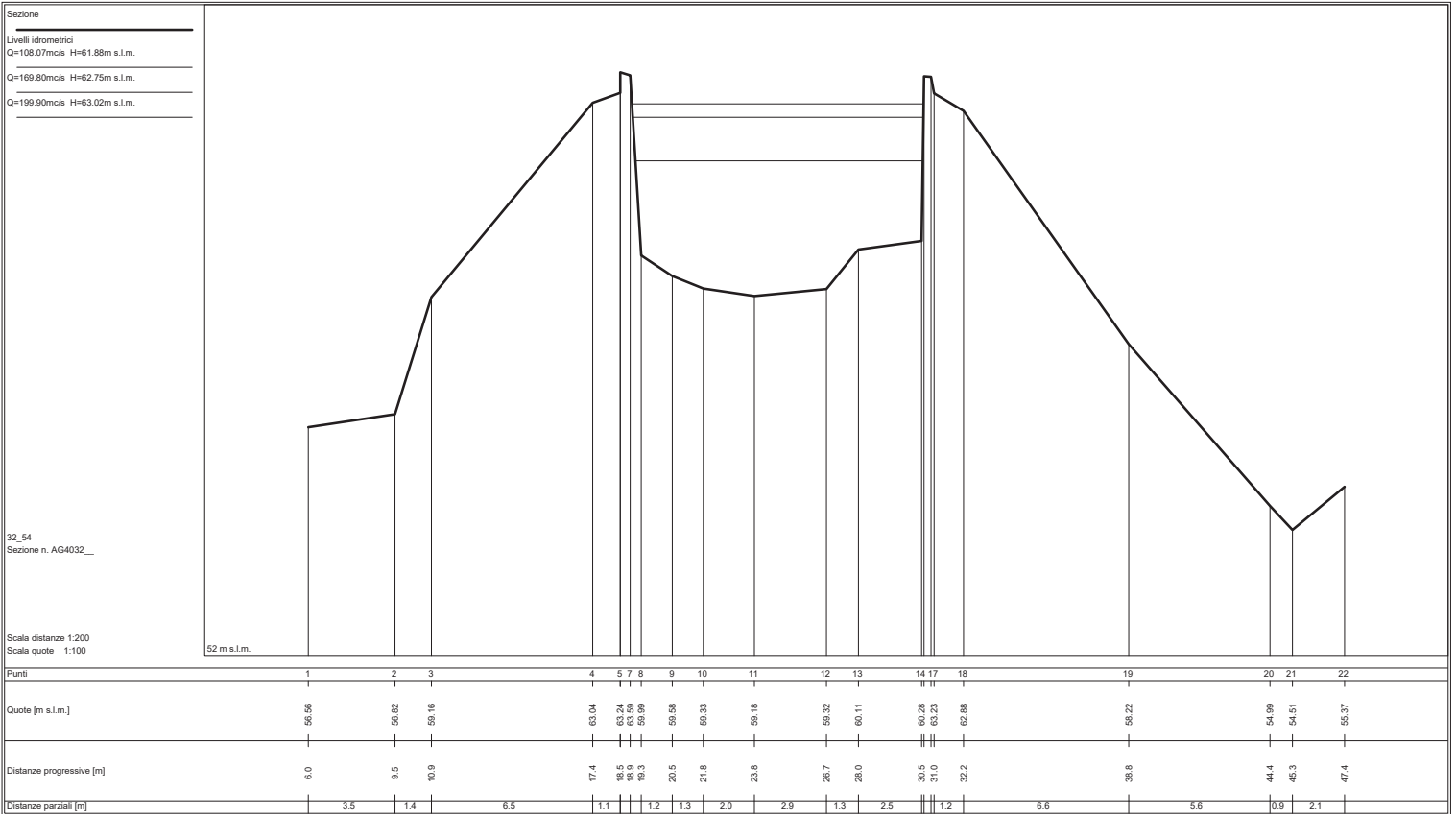

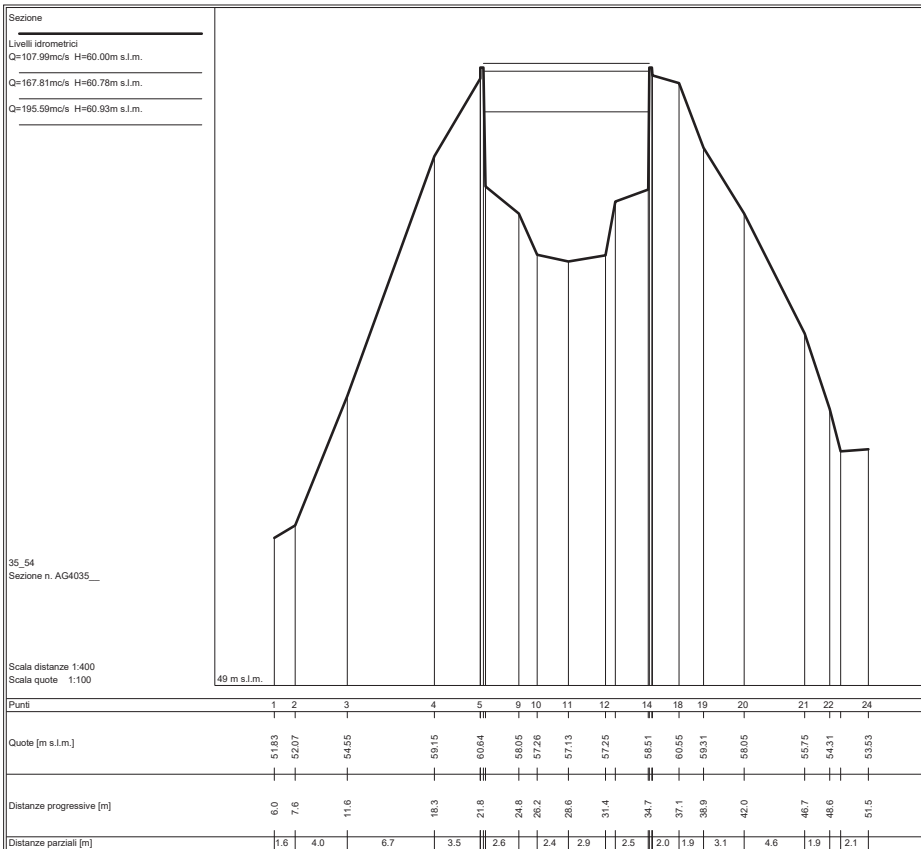
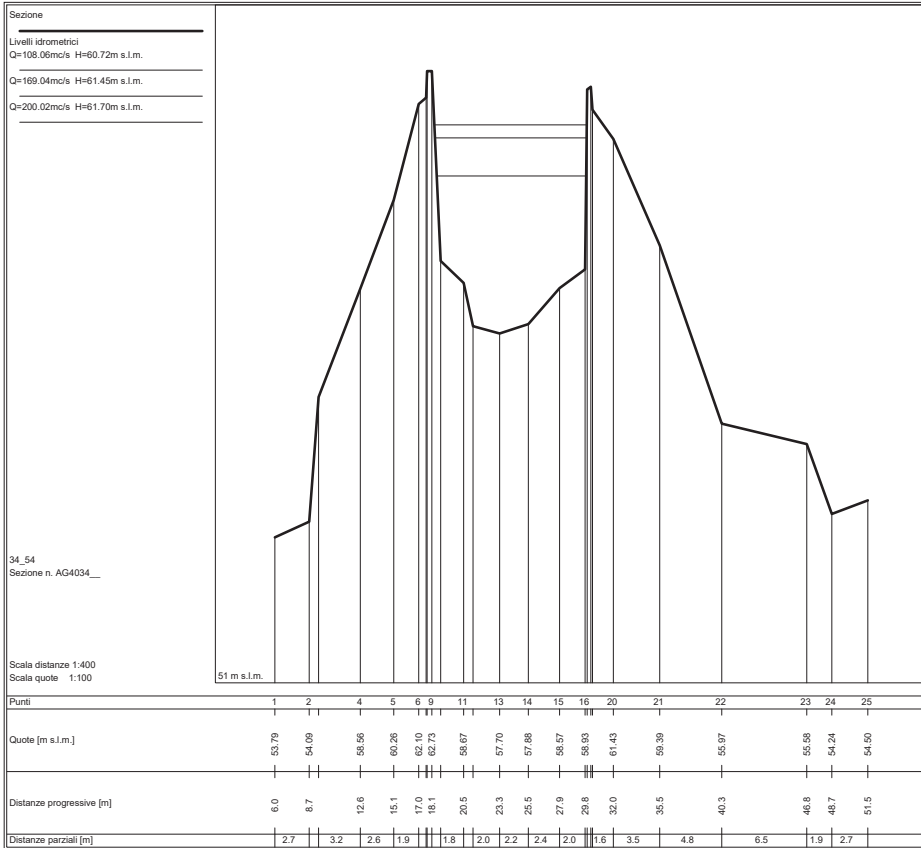



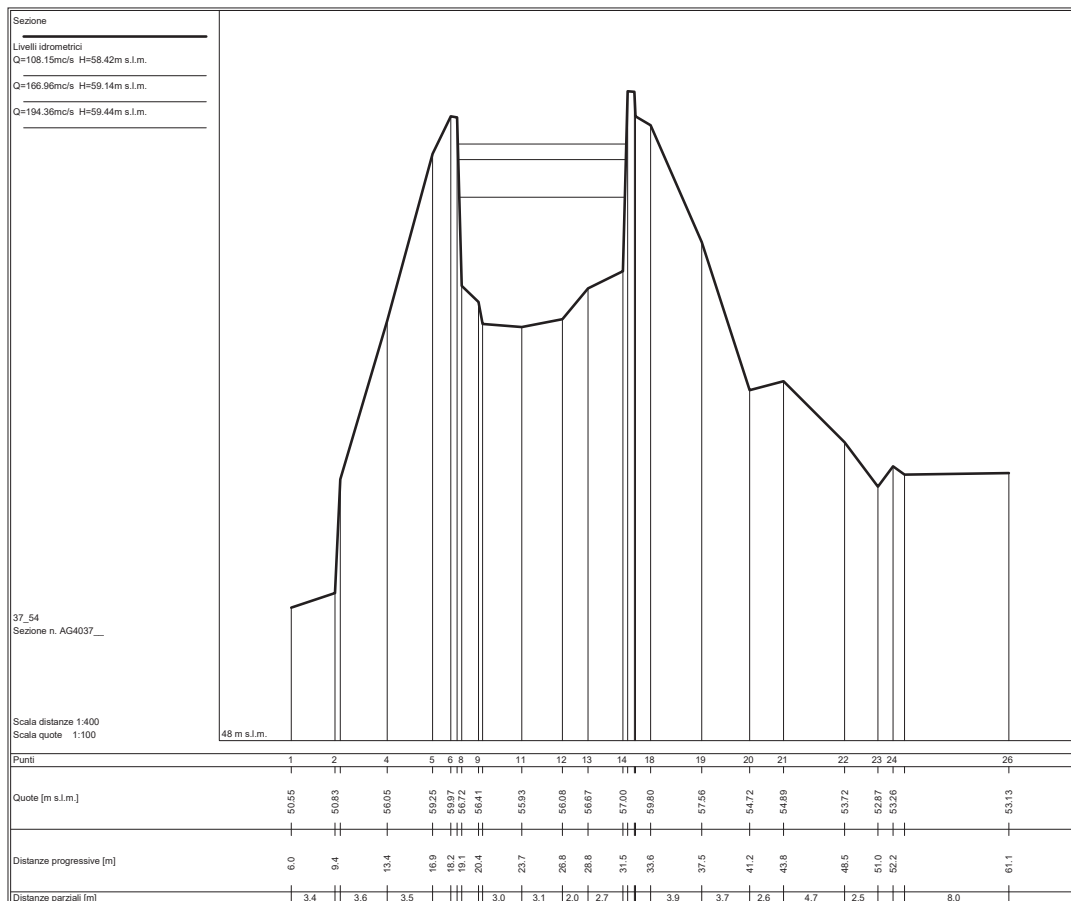
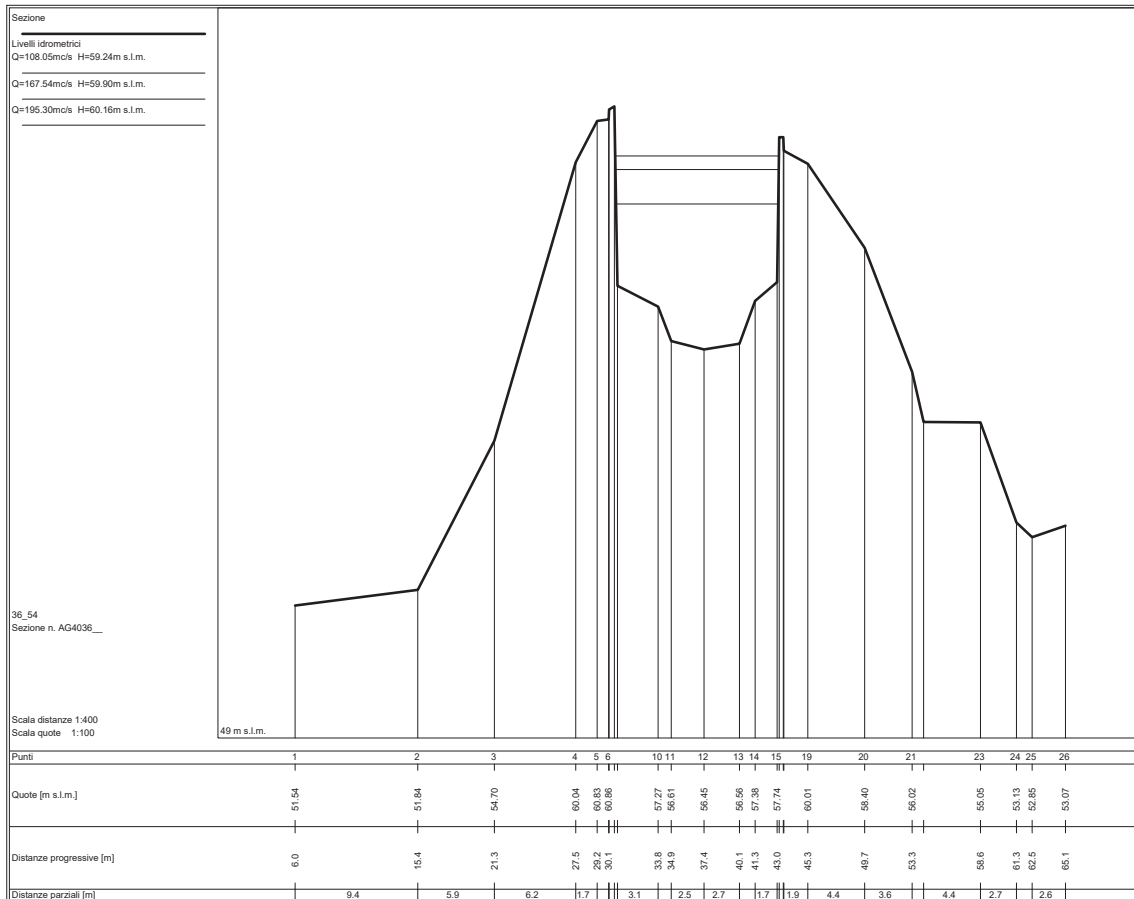

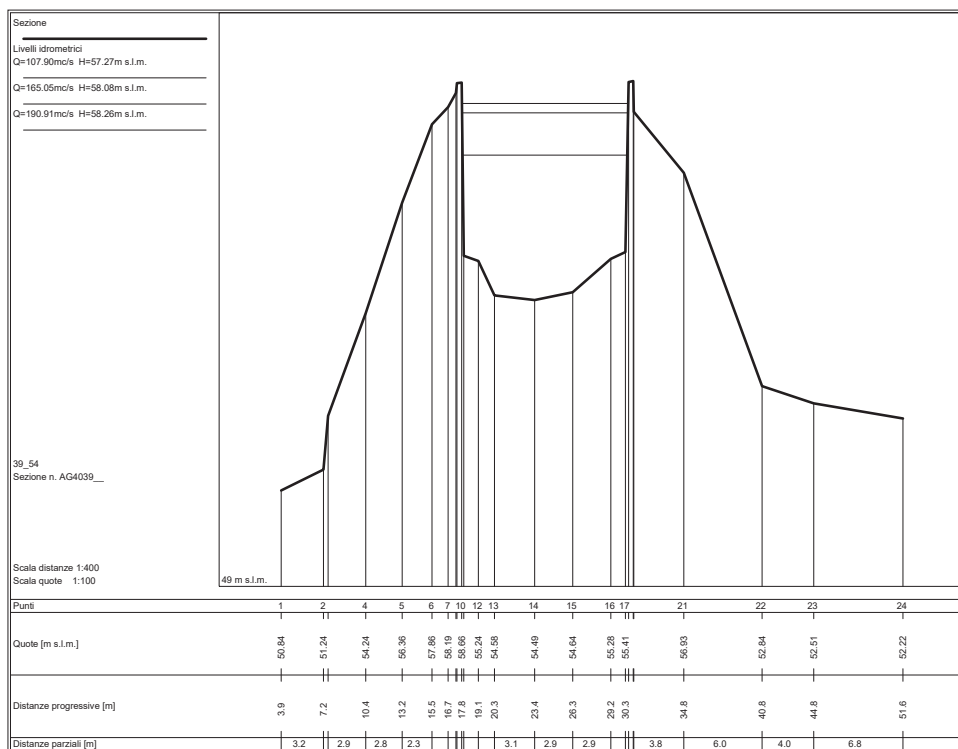
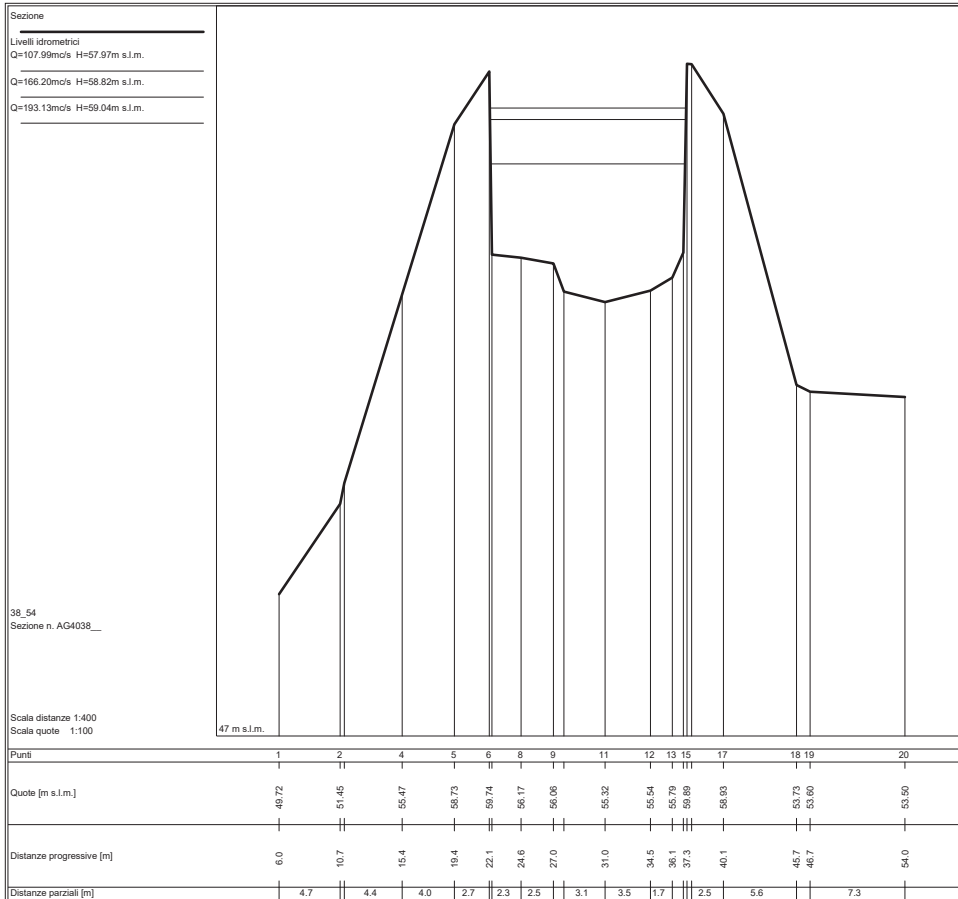

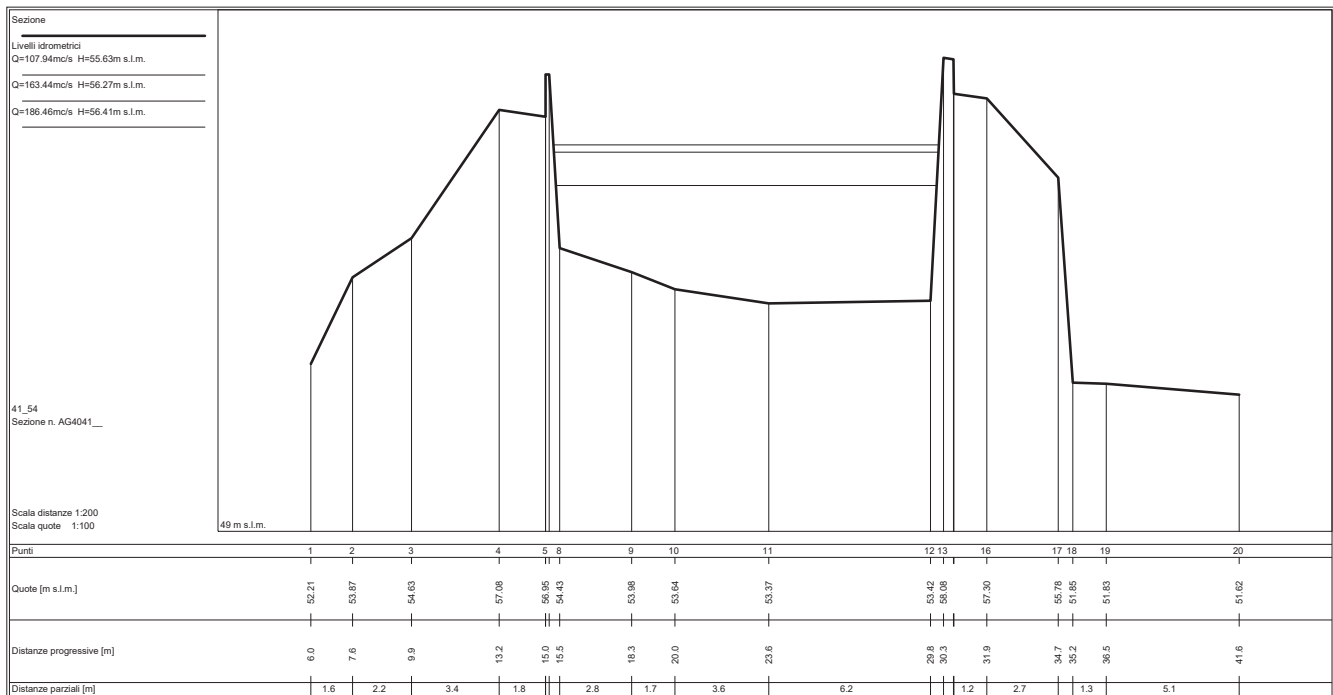
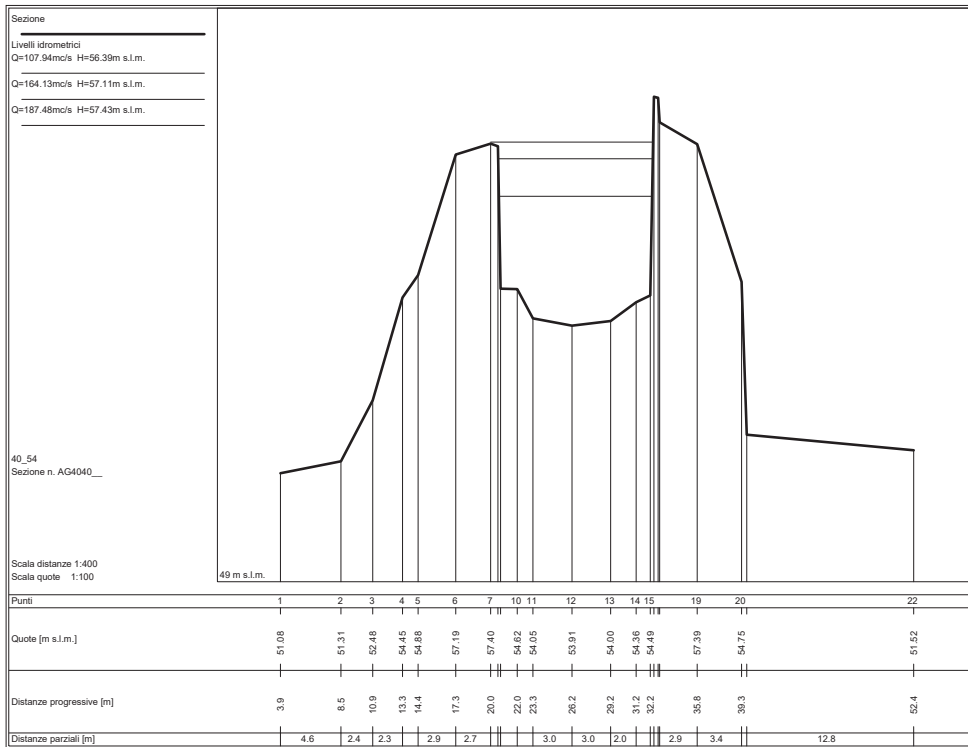

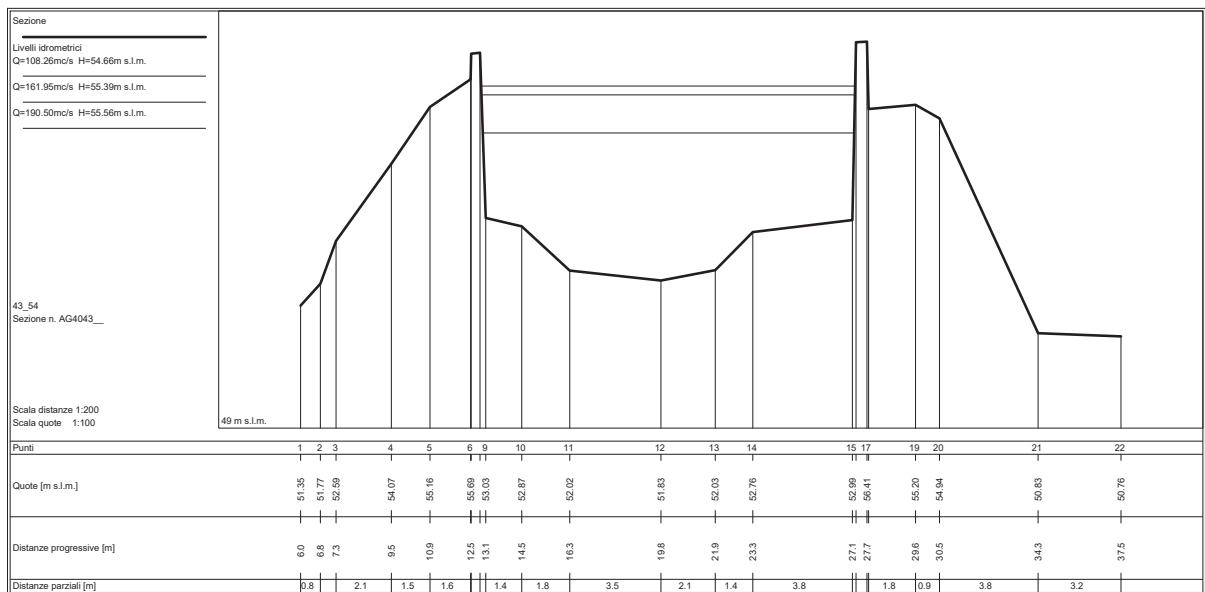
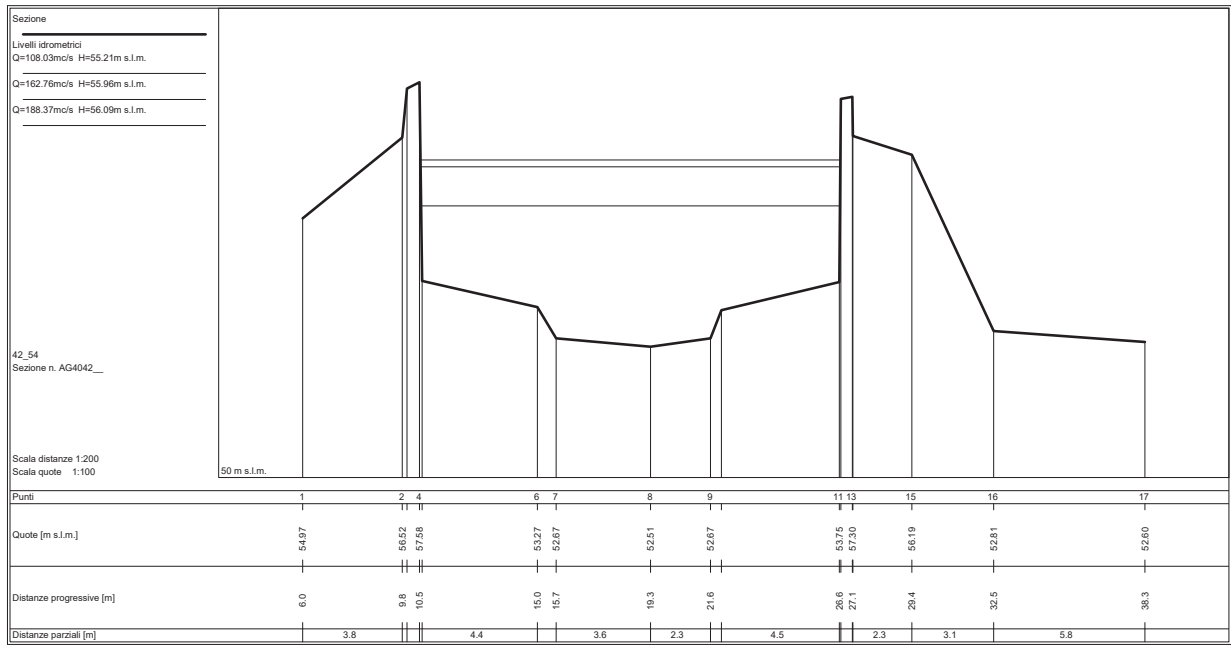

Sezione  
 Livelli idrometrici  
 Q=108.38mc/s H=54.21m s.l.m.  
 Q=161.03mc/s H=54.98m s.l.m.  
 Q=192.33mc/s H=55.17m s.l.m.

44\_54  
 Sezione n. AG4044\_

Scala distanze 1:200  
 Scala quote 1:100

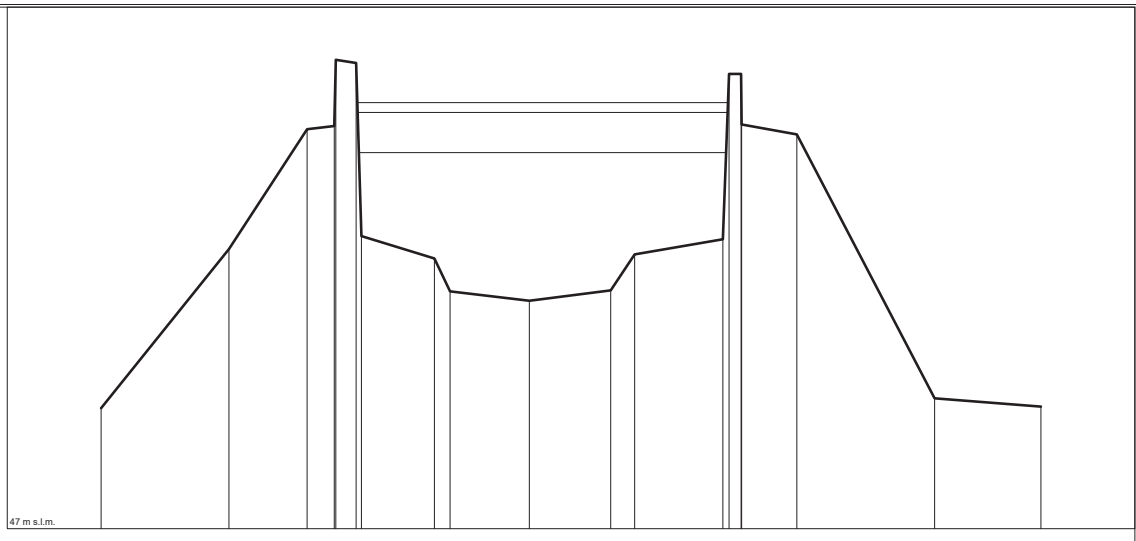

Punti	1	2	3	4	6	8	9	10	11	12	13	15	17	18	19
Quote [m s.l.m.]	49.31	52.36	54.66	54.72	55.83	52.19	51.55	51.37	51.57	52.26	52.55	55.72	54.56	49.50	49.34
Distanze progressive [m]	6.0	10.9	13.9	14.9	15.8	18.8	19.4	22.4	25.5	26.5	29.8	30.5	32.7	38.0	42.0
Distanze parziali [m]		4.9	3.0	1.0	0.8	2.8	3.0	3.1	0.9	3.4	2.1	2.1	5.3	4.1	

Sezione  
 Livelli idrometrici  
 Q=108.15mc/s H=53.50m s.l.m.  
 Q=161.40mc/s H=54.22m s.l.m.  
 Q=194.22mc/s H=54.42m s.l.m.

45\_54  
 Sezione n. AG4045\_

Scala distanze 1:200  
 Scala quote 1:100

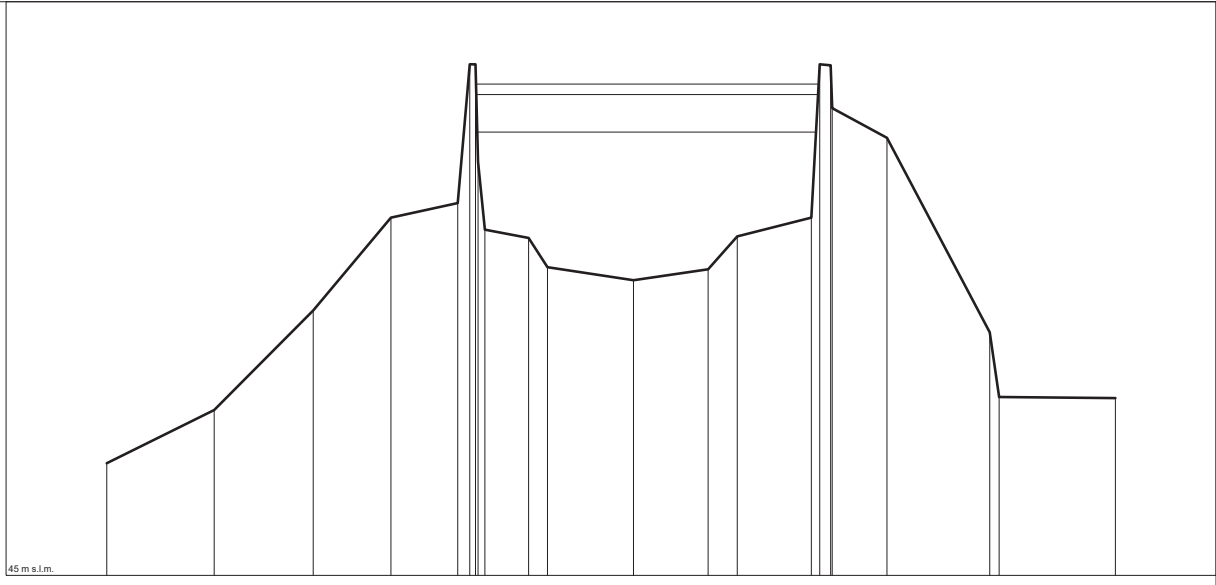

Punti	1	2	3	4	5	6	7	8	9	10	11	12	13	14	15	17	19	20	22
Quote [m s.l.m.]	47.16	48.17	50.08	51.66	52.14	51.80	51.55	51.47	50.91	50.06	50.06	50.87	51.50	51.86	54.79	53.39	49.66	48.40	
Distanze progressive [m]	6.0	10.1	13.9	16.9	19.5	19.9	20.5	22.2	22.9	26.2	26.2	29.1	30.2	33.0	33.7	35.9	39.9	44.7	
Distanze parziali [m]		4.1	3.8	3.0	2.6	0.4	0.6	1.7	0.7	3.3	2.9	1.1	2.8	2.1	2.1	3.9	4.5		

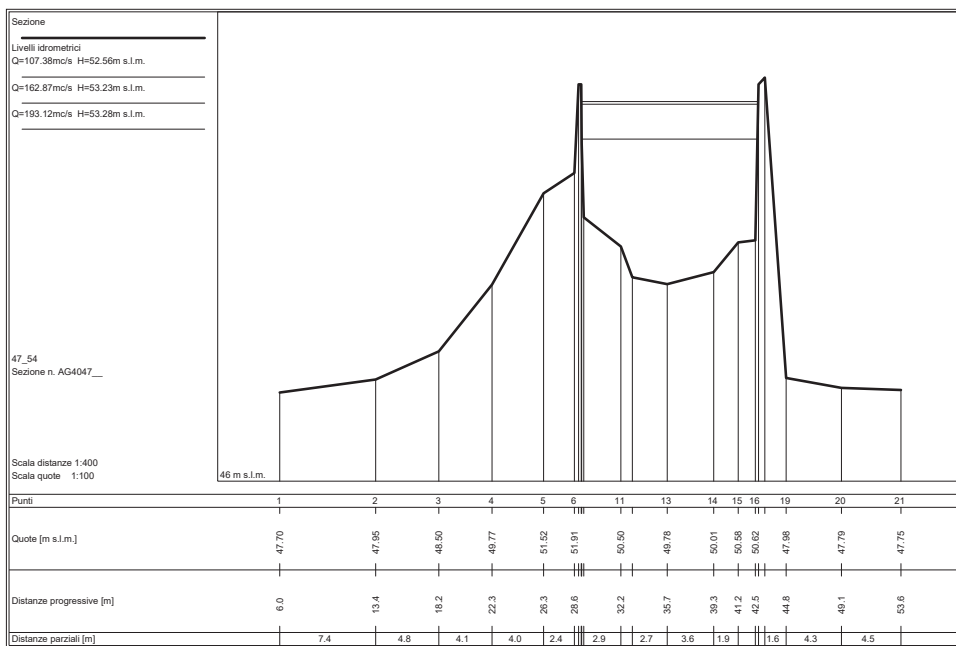
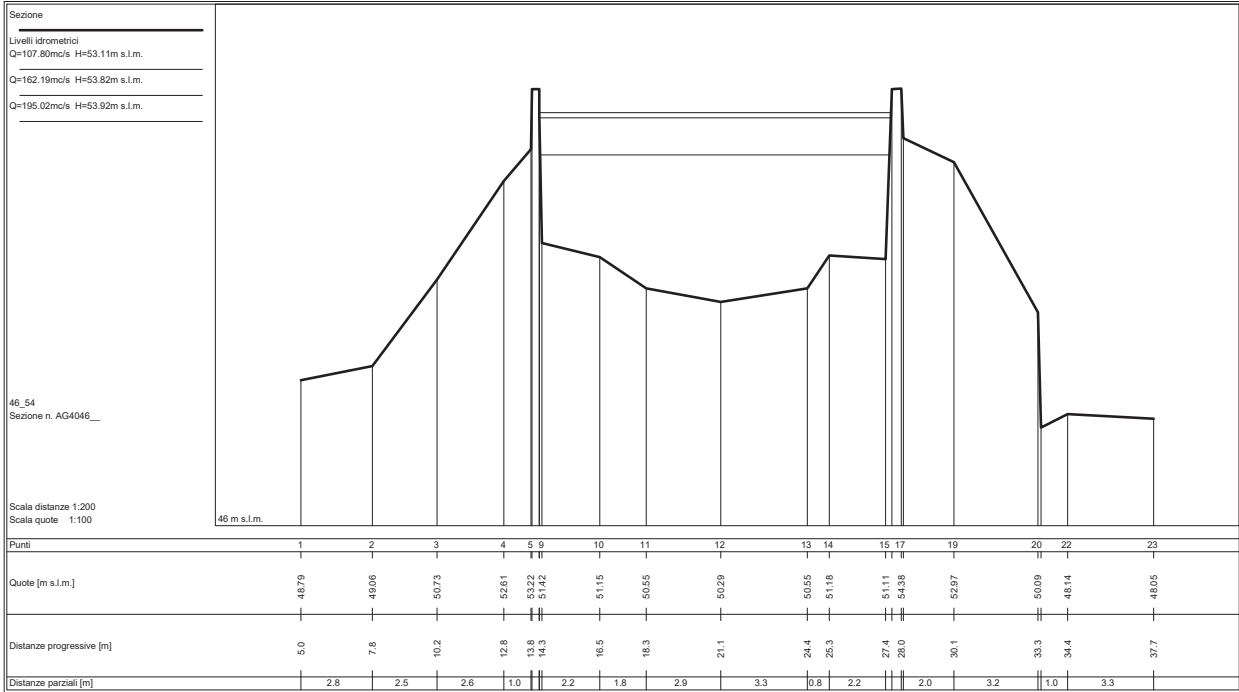

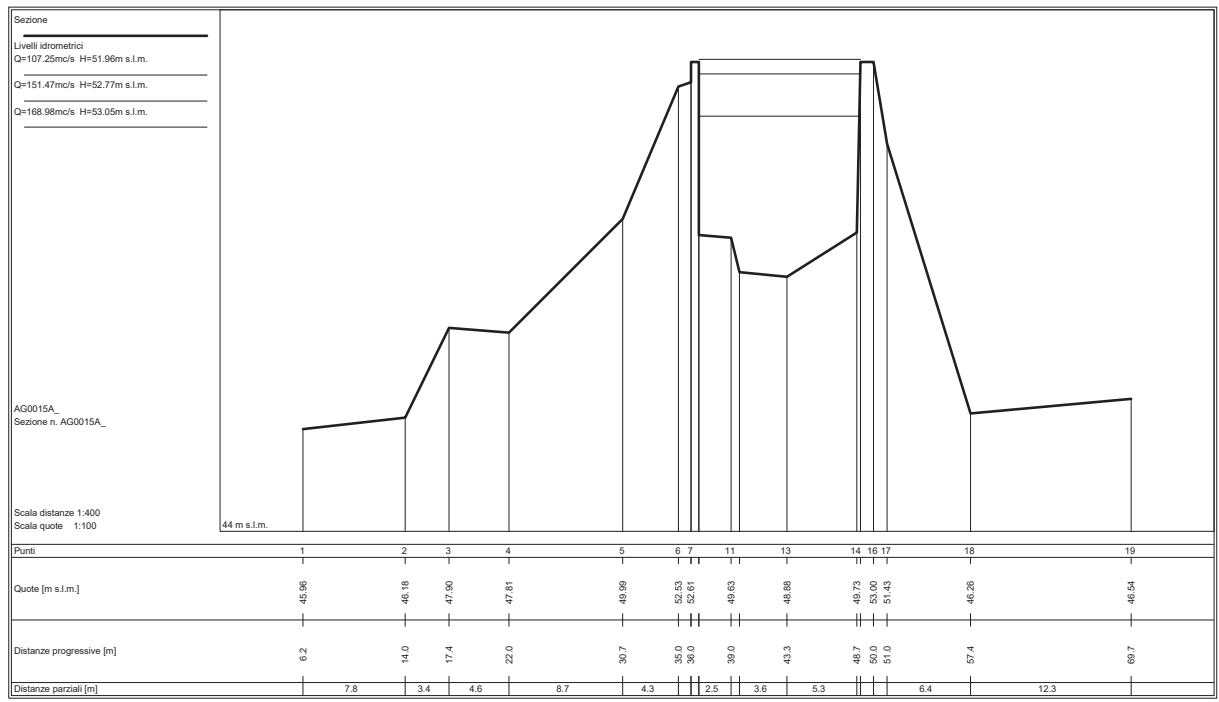
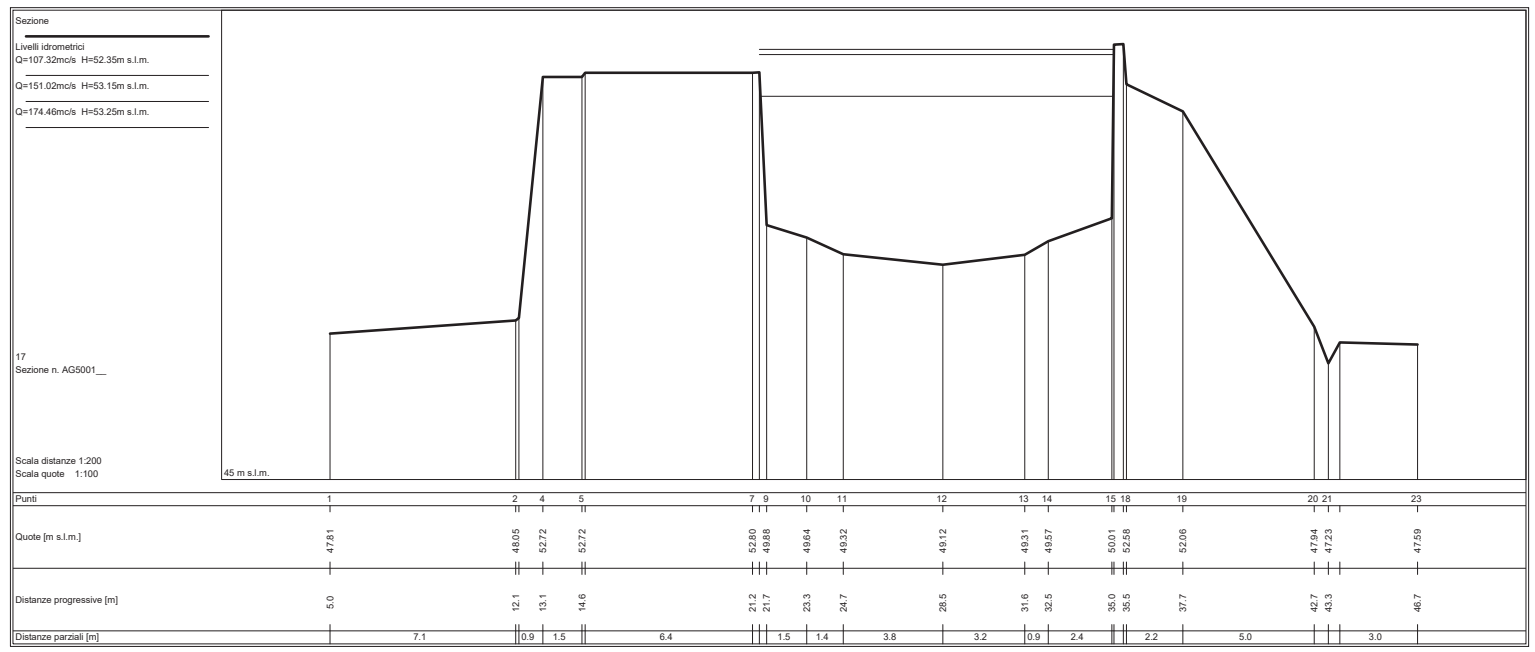

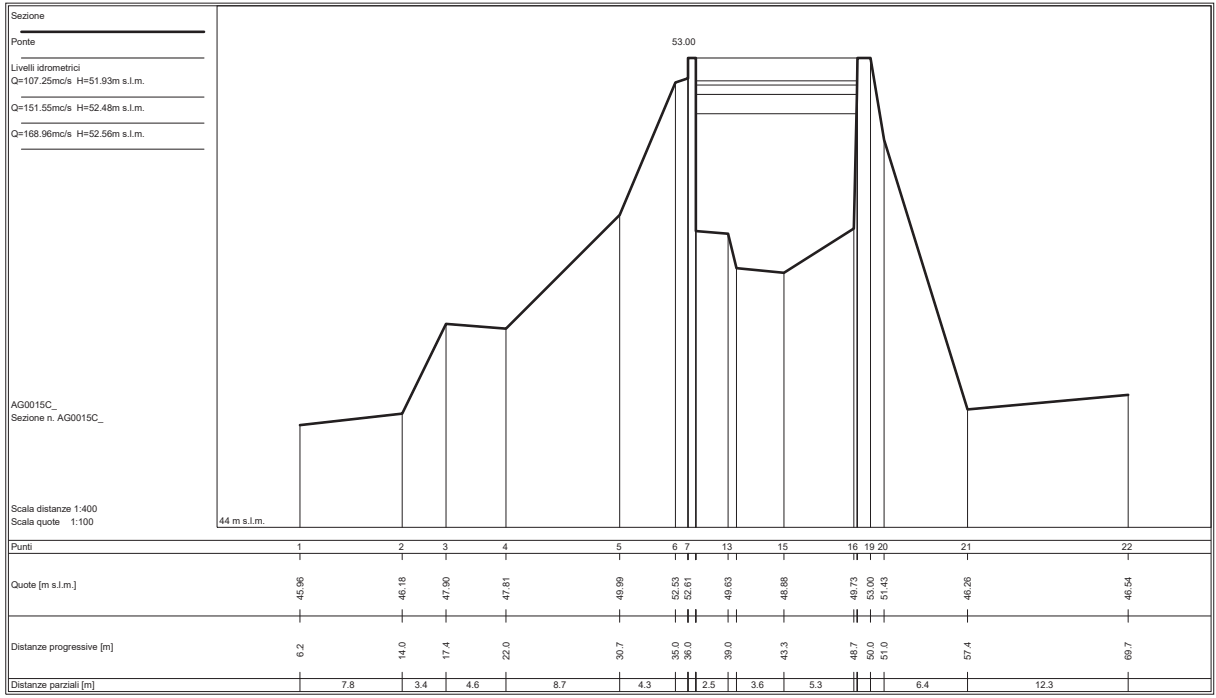
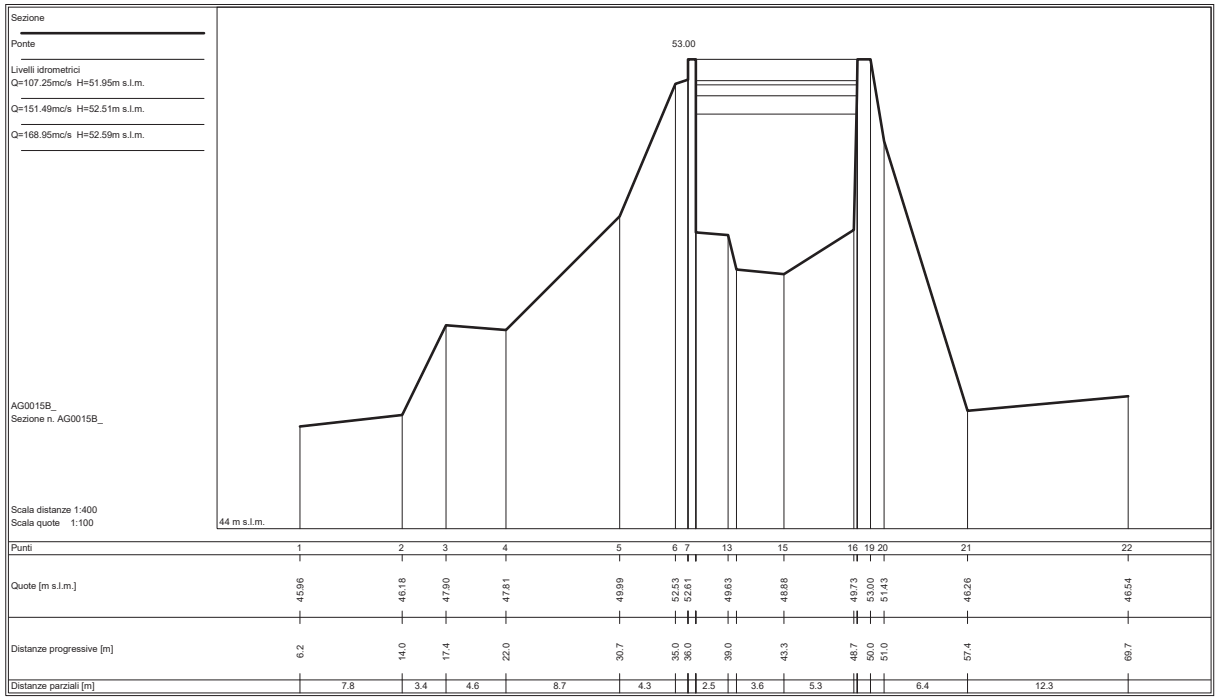



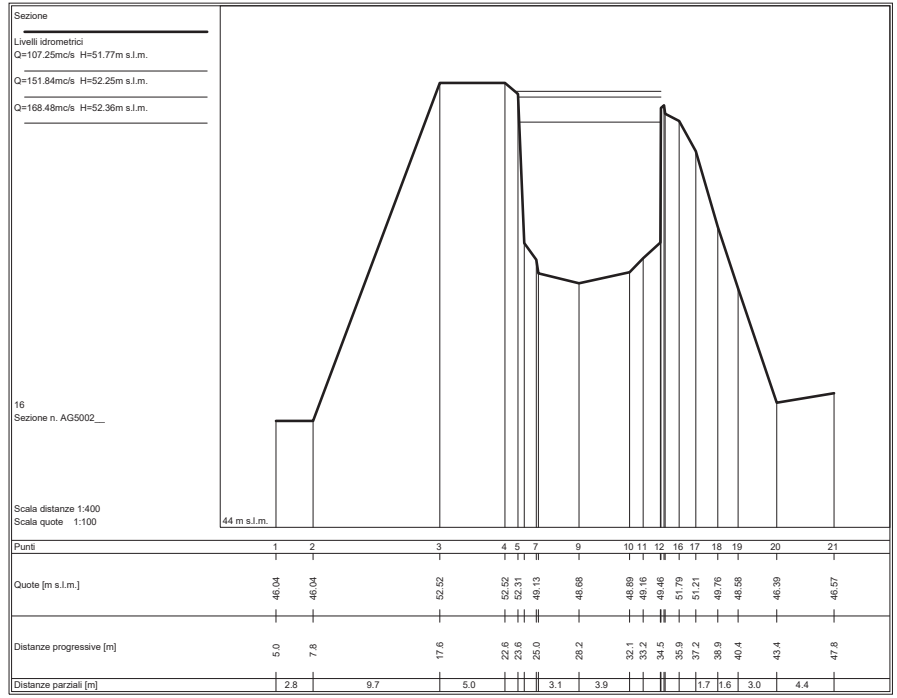
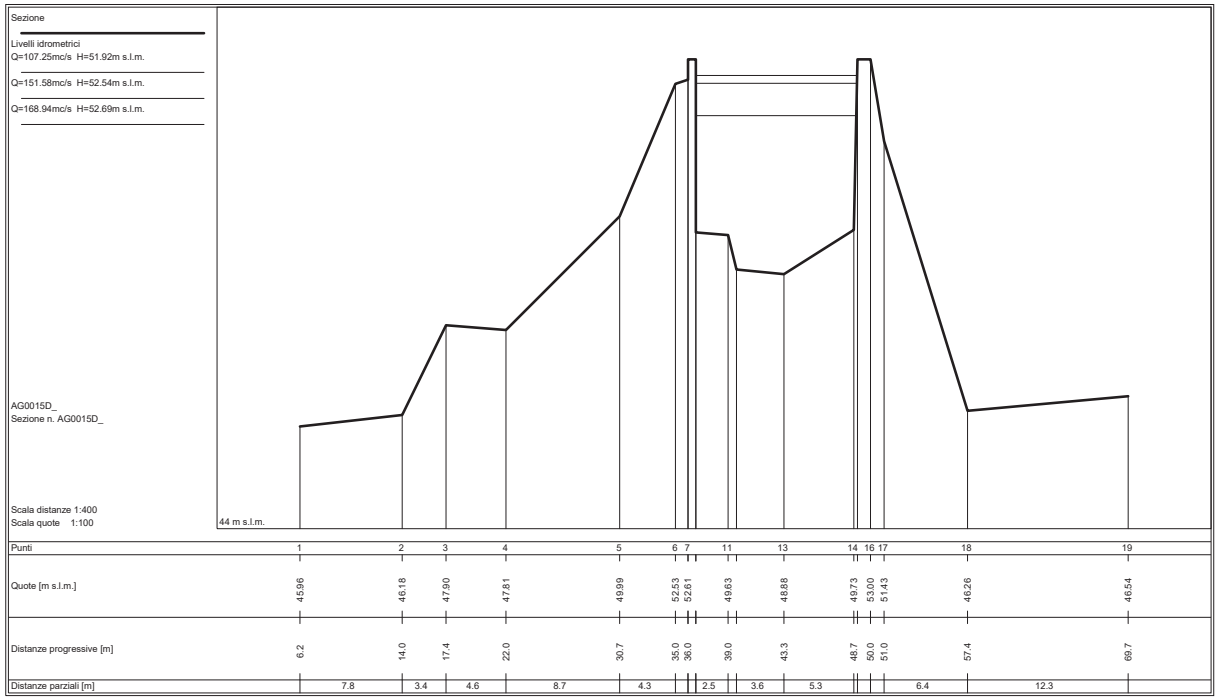

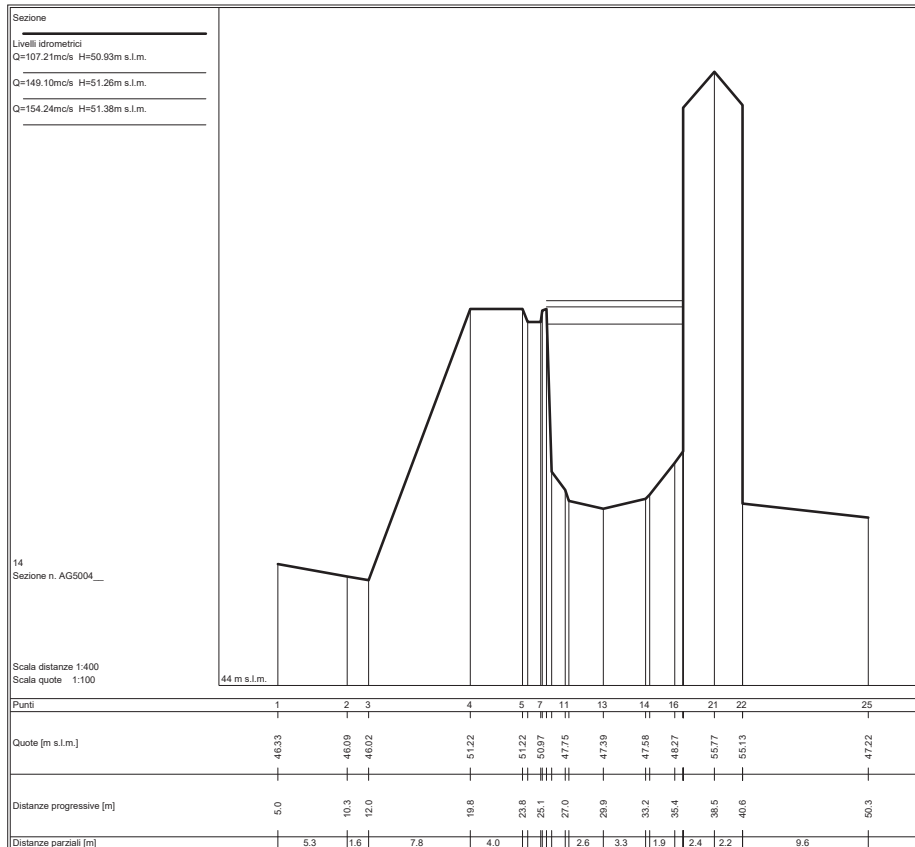
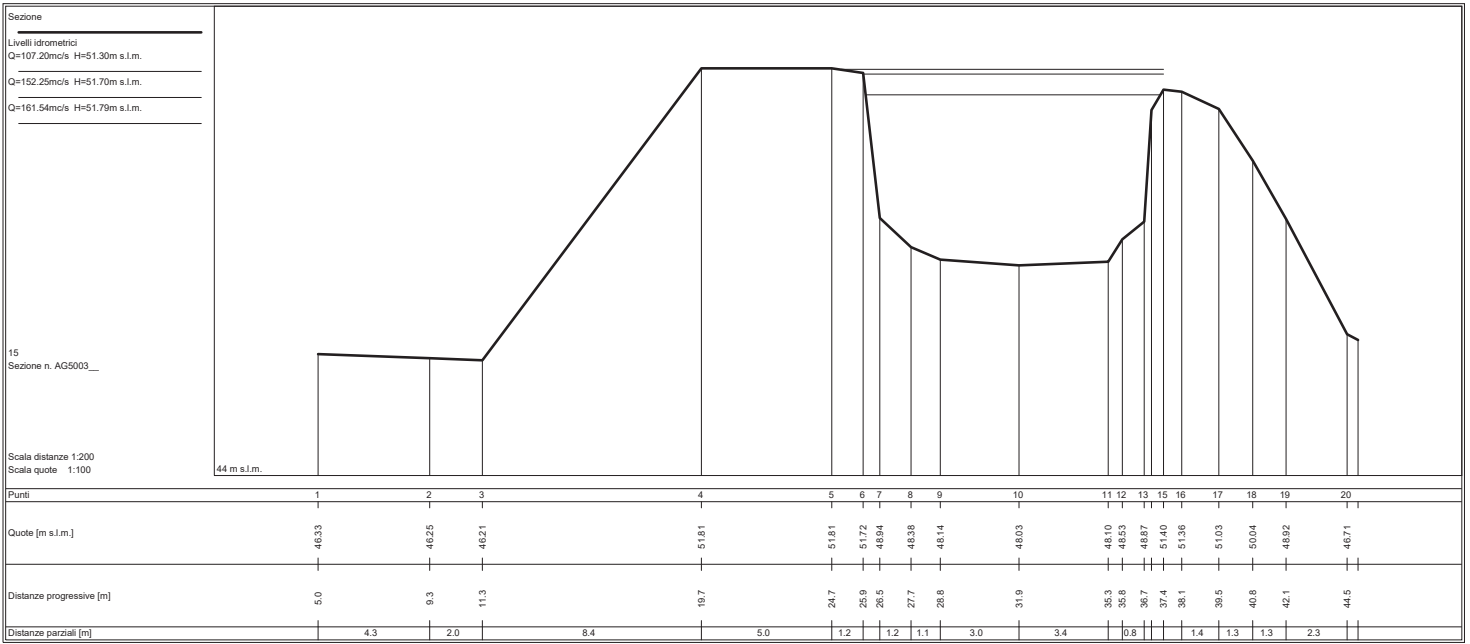

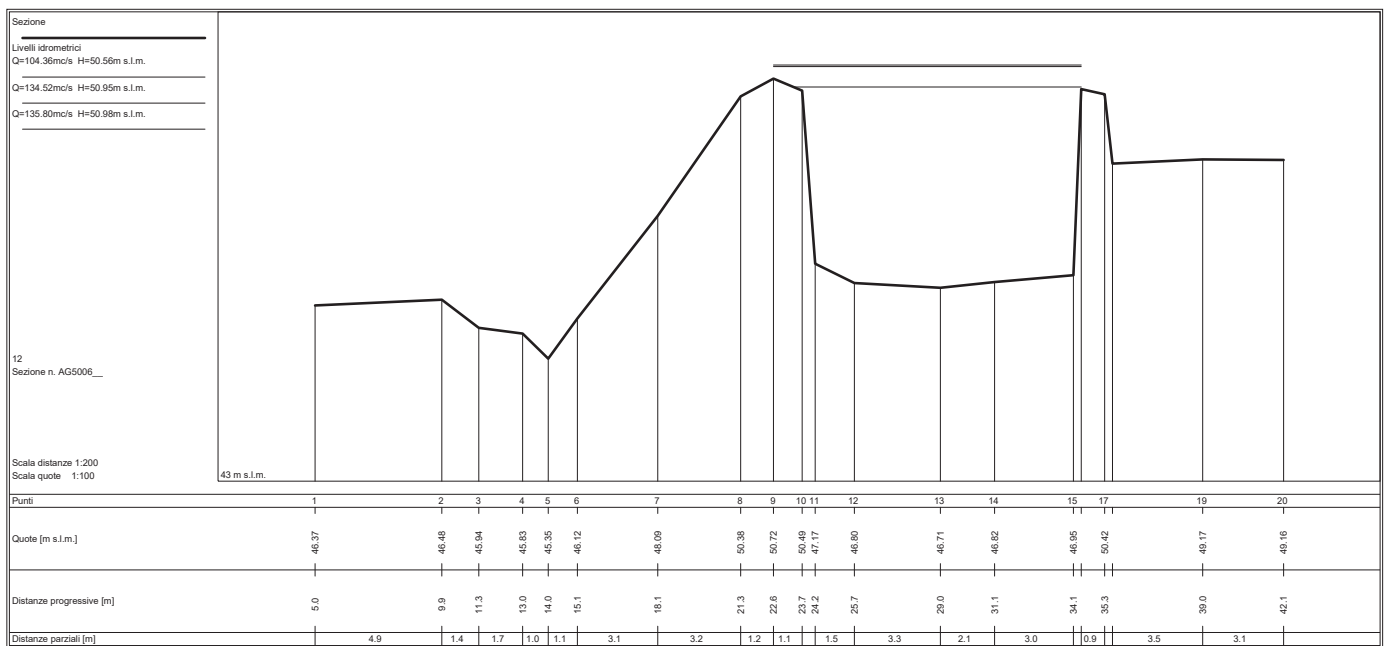
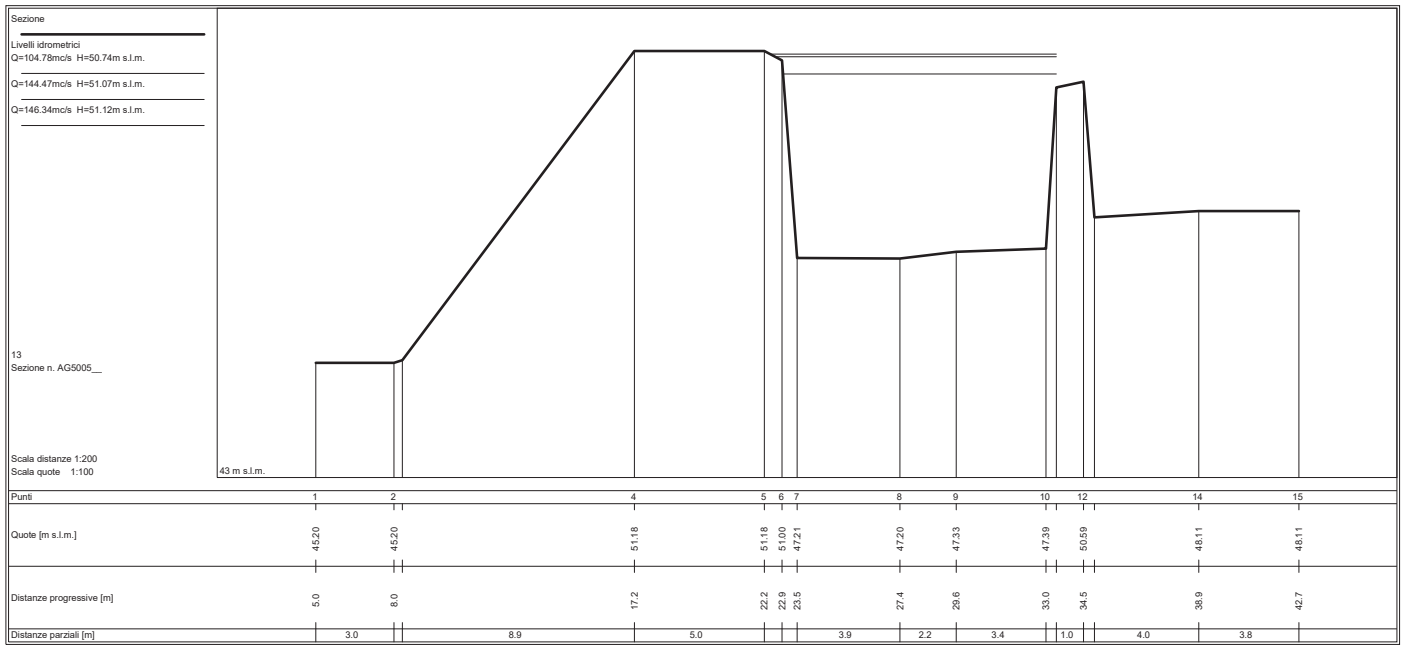

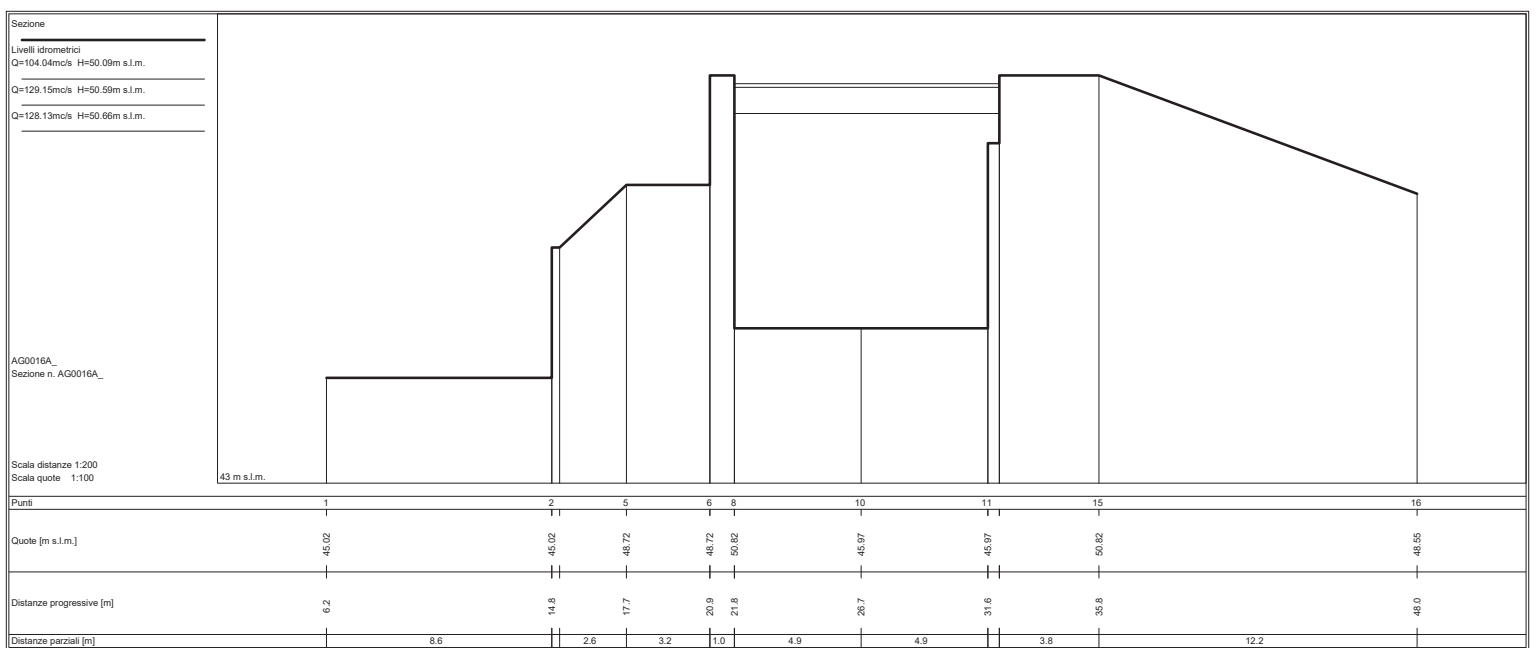
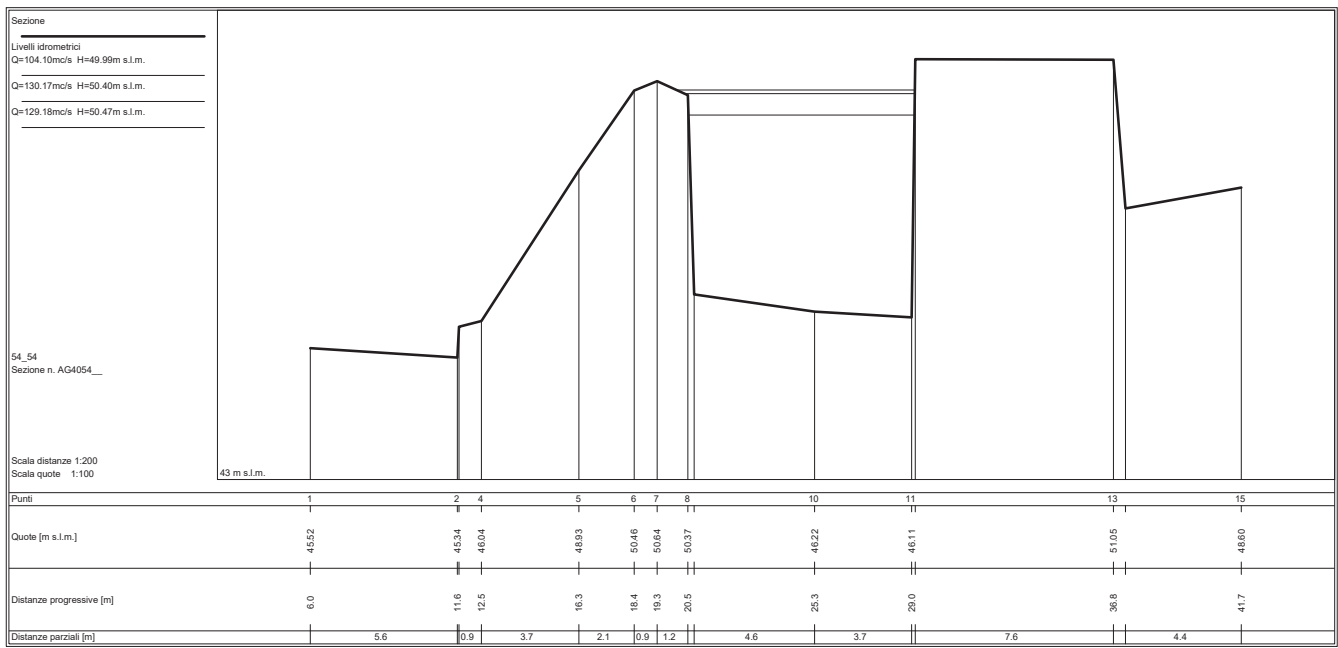

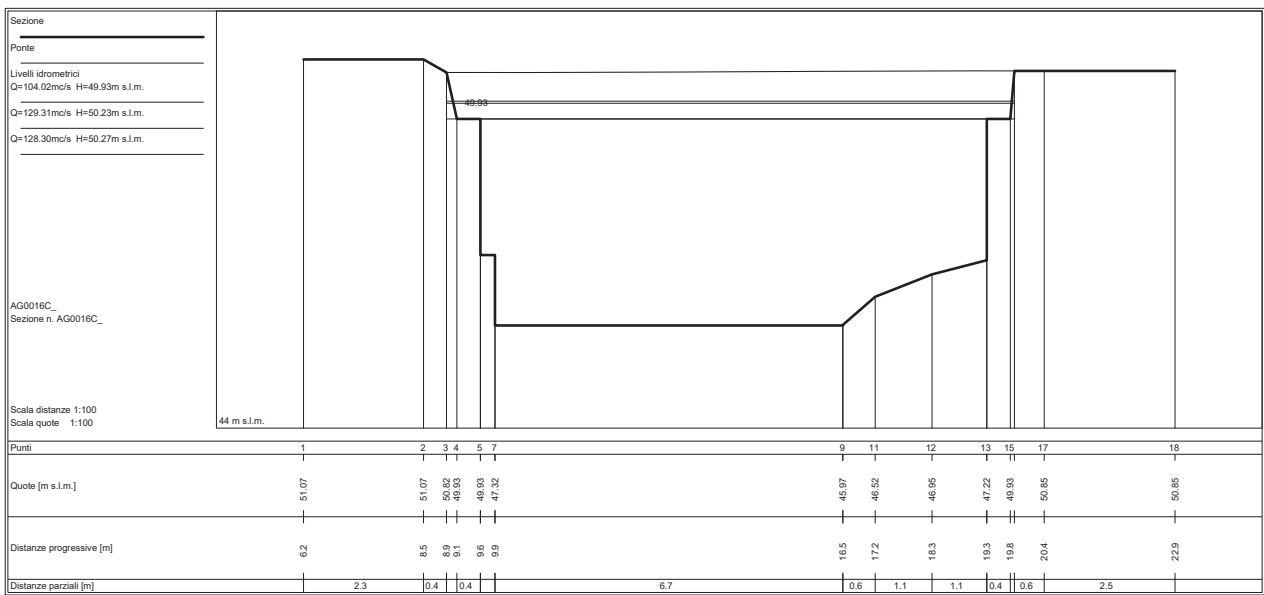
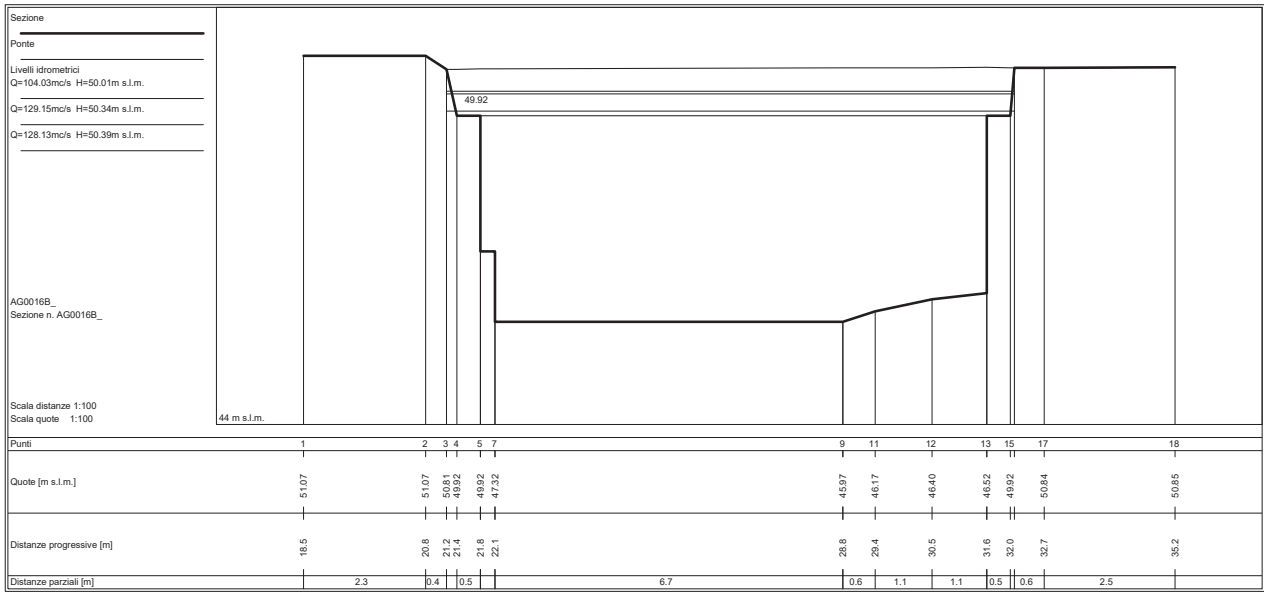

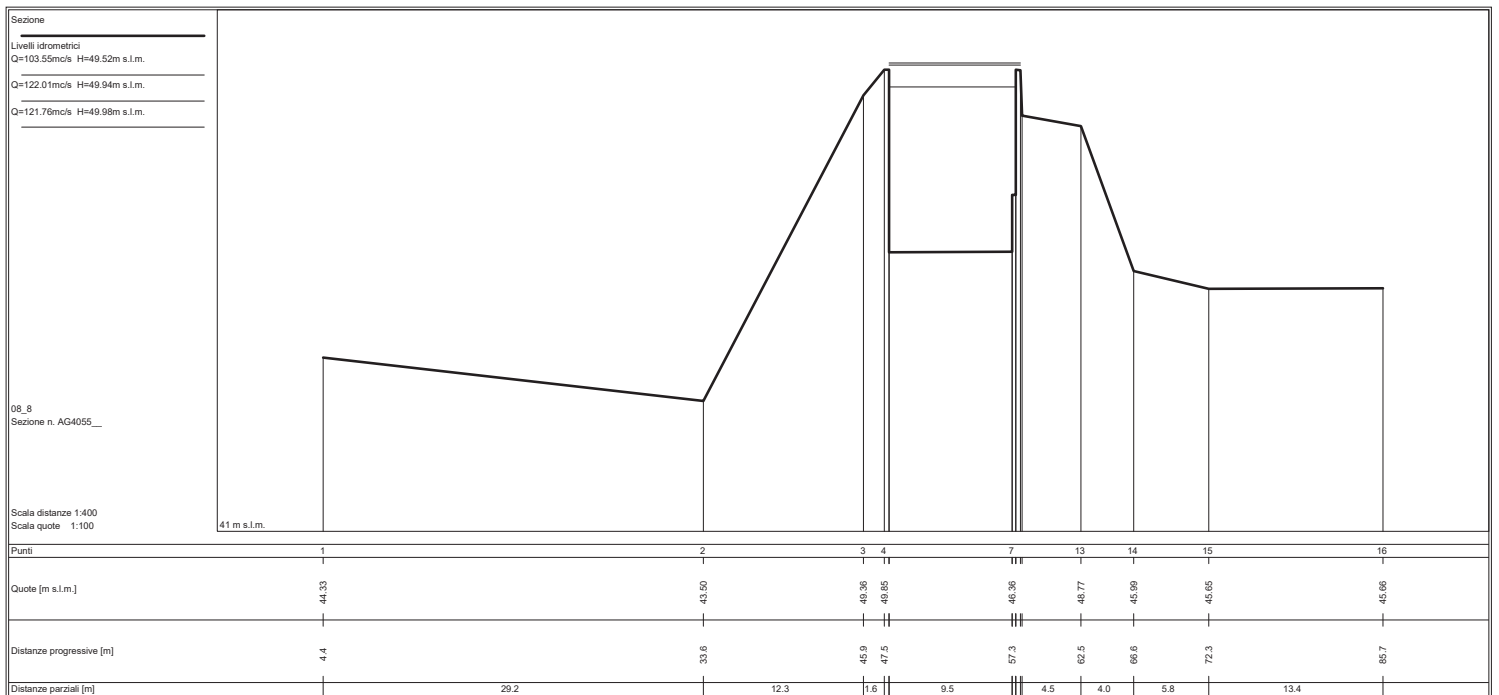
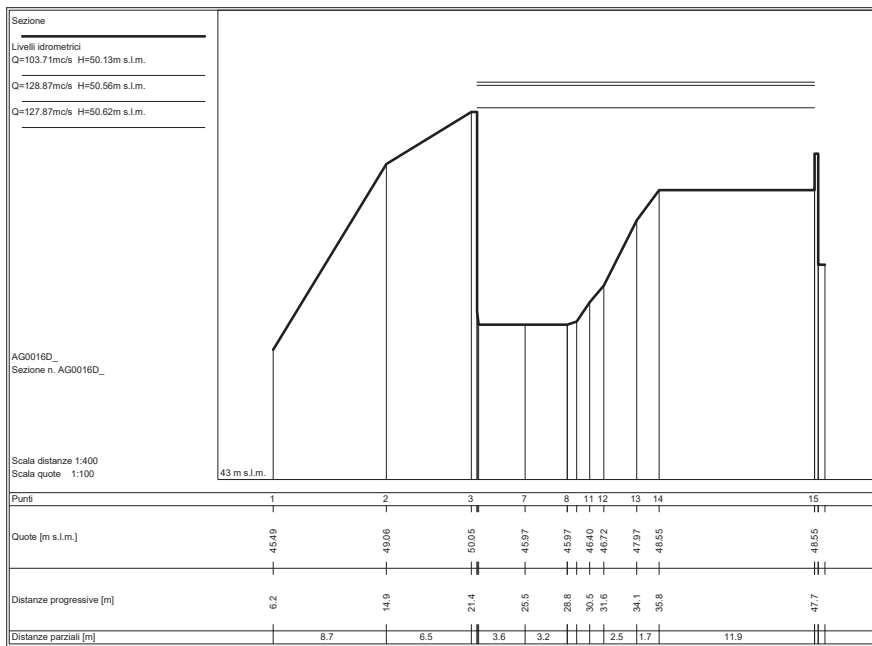

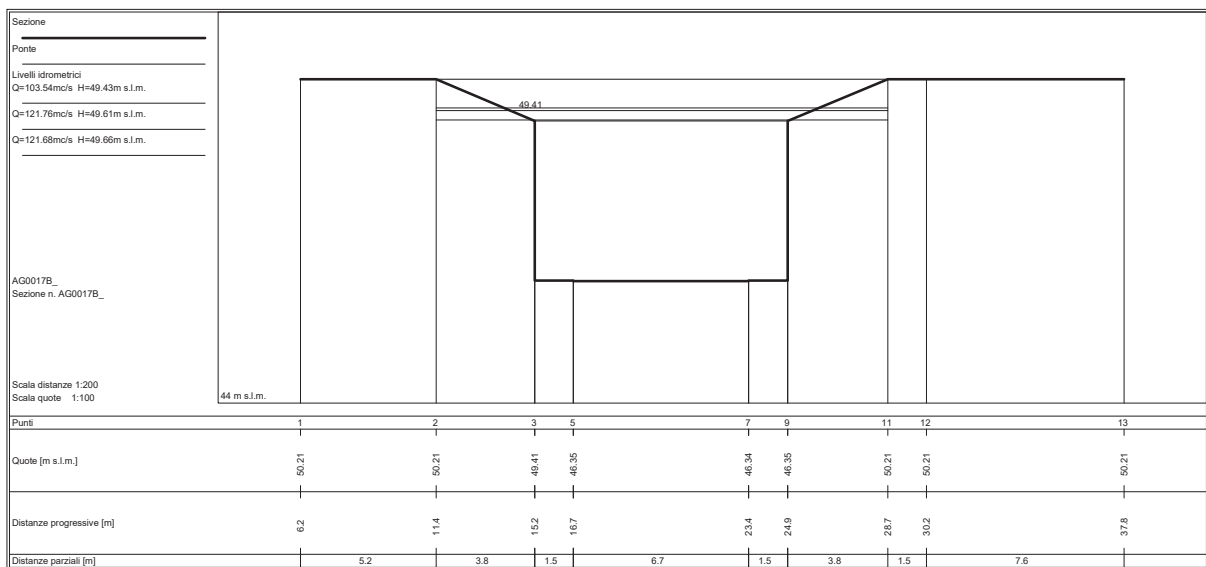
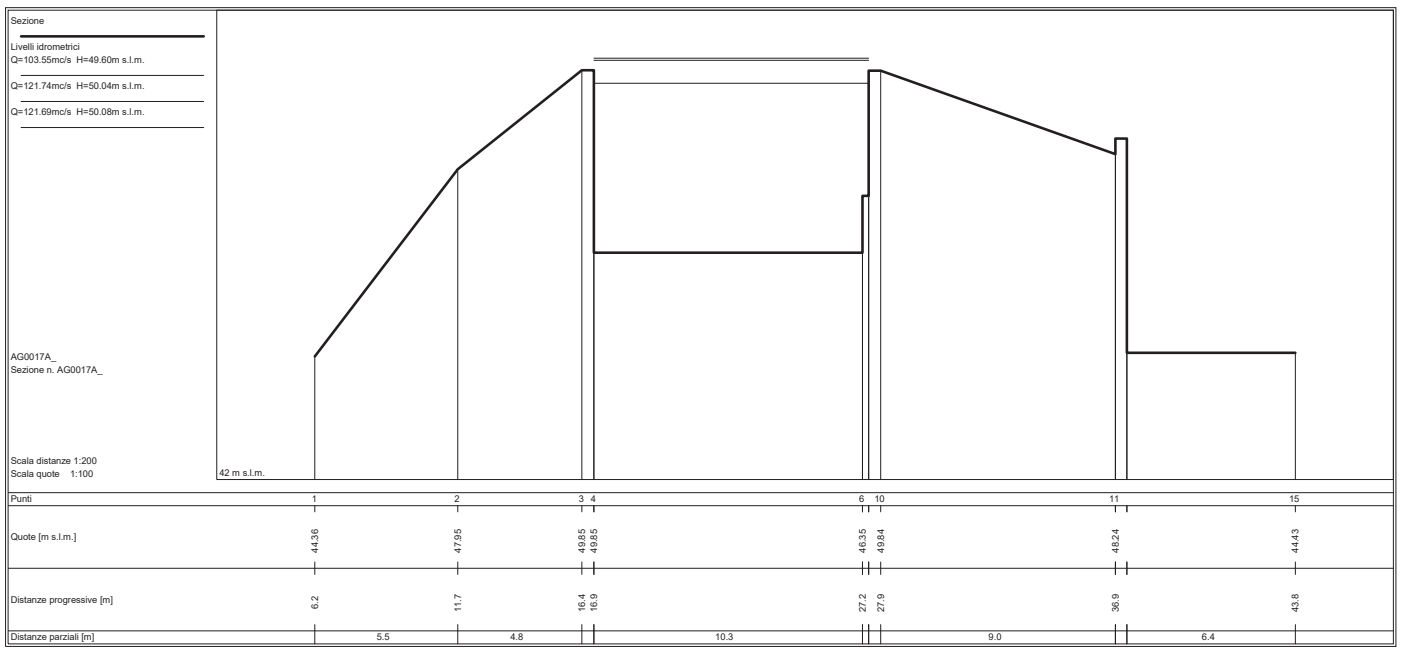

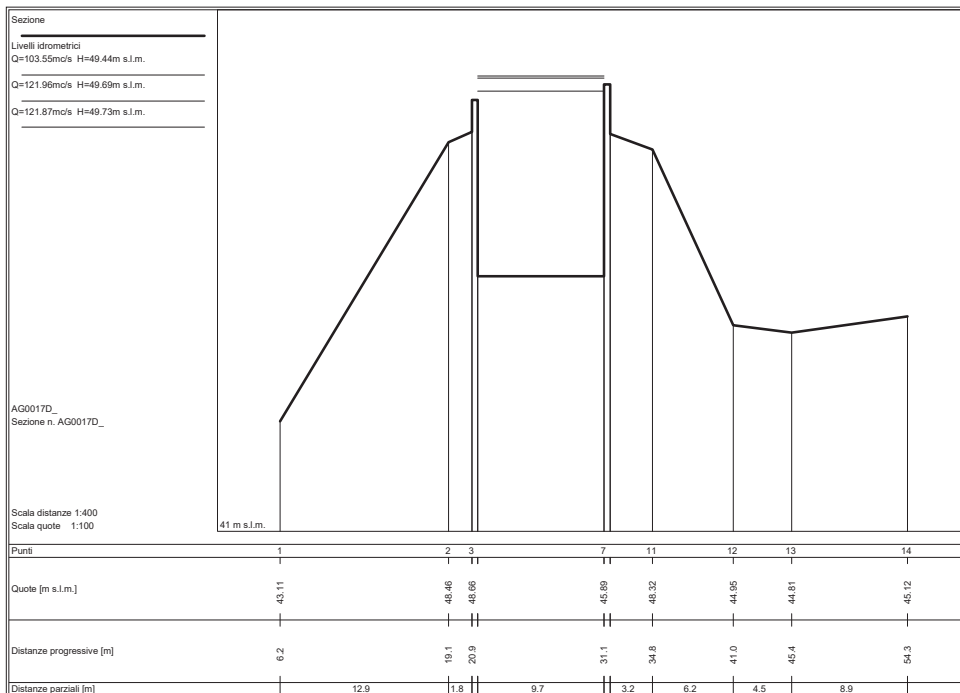
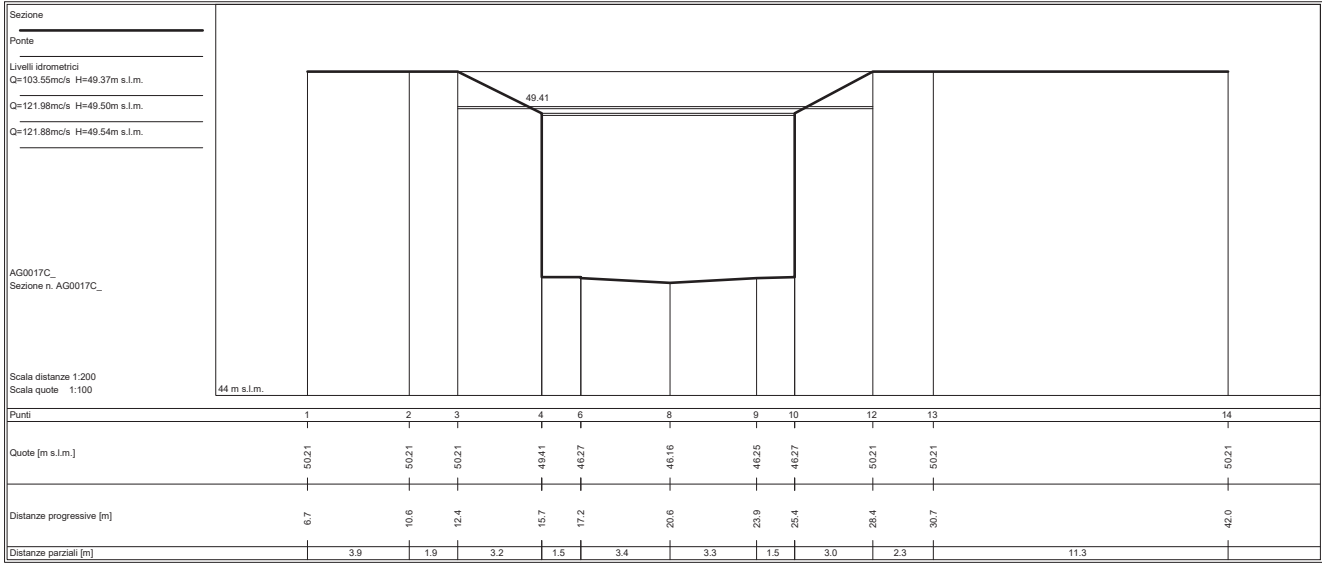



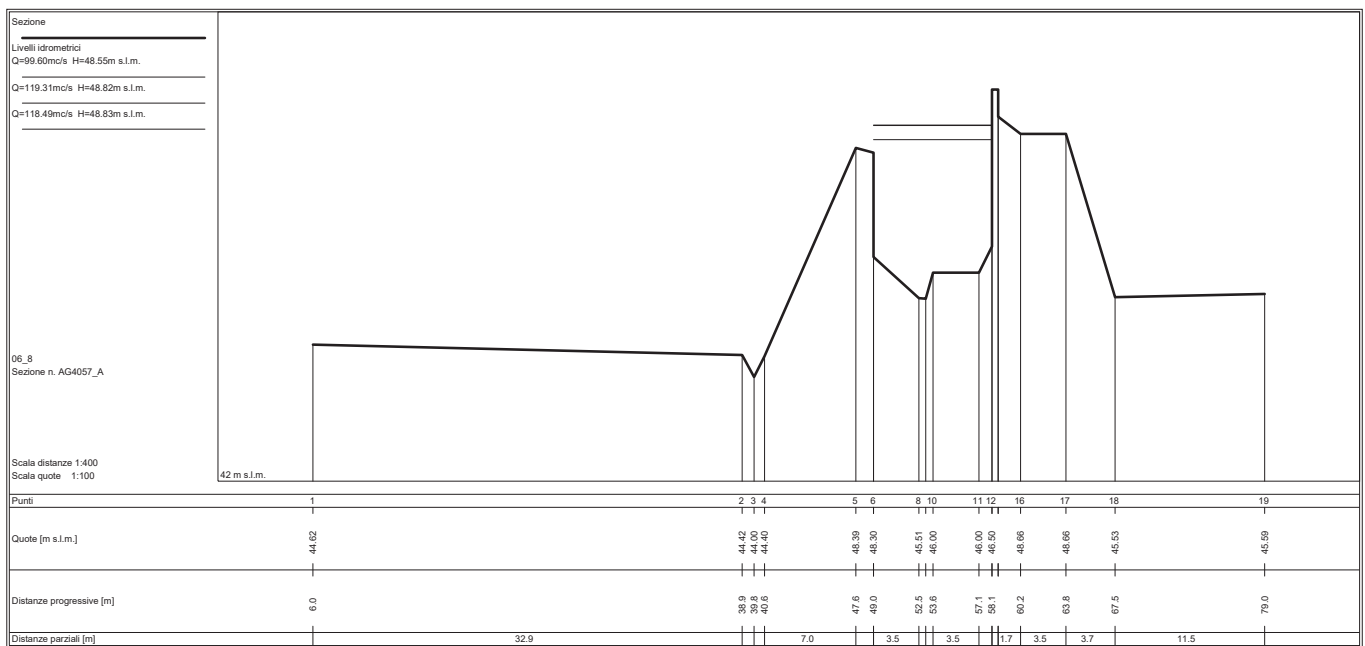
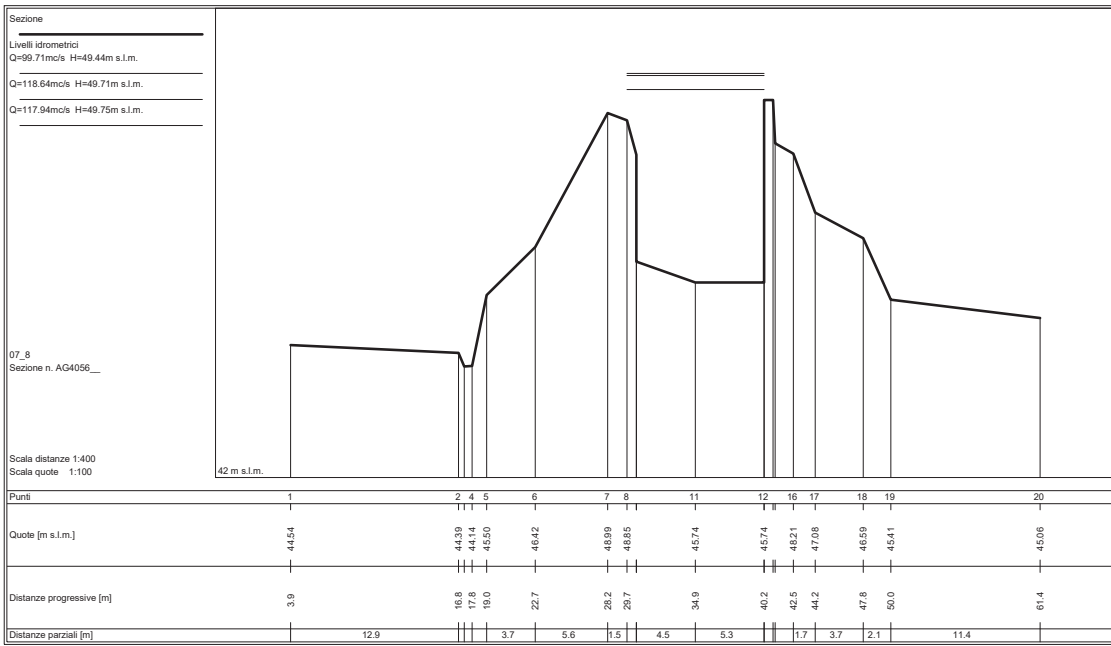

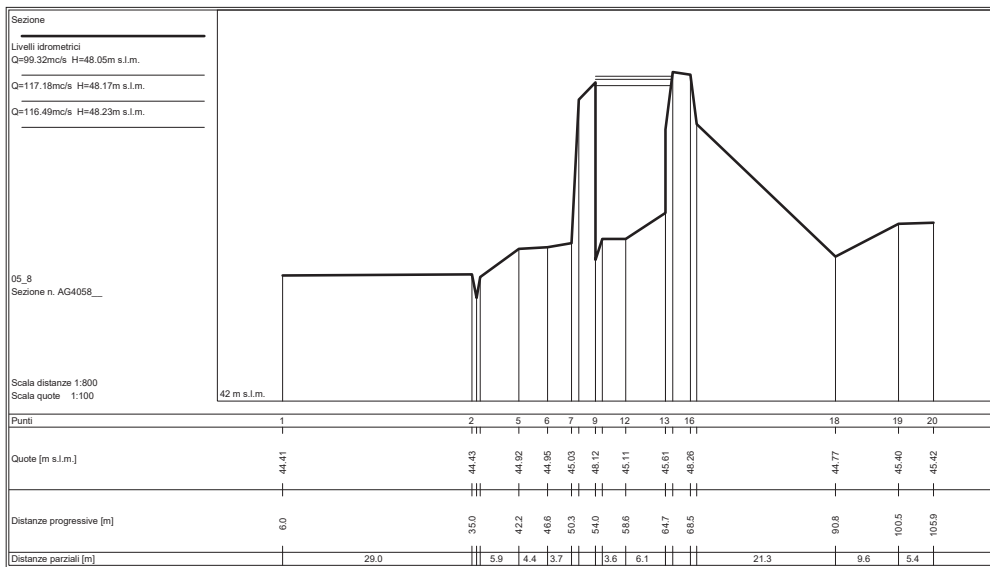
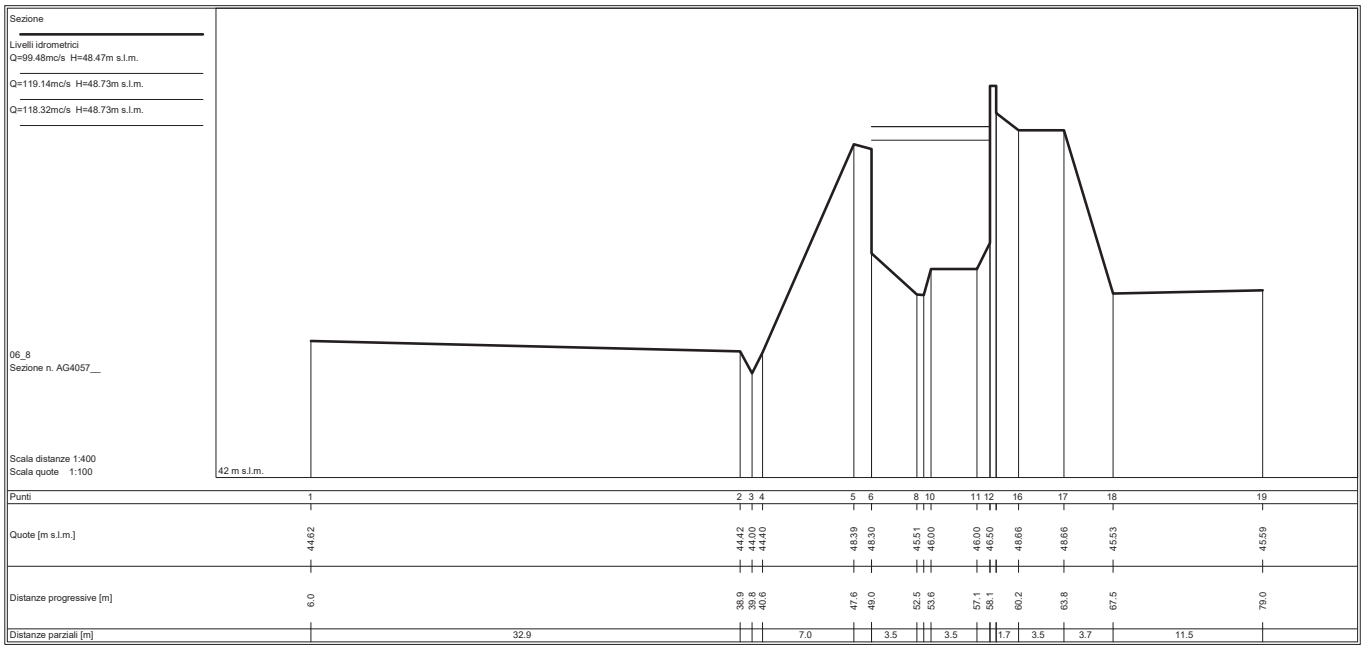

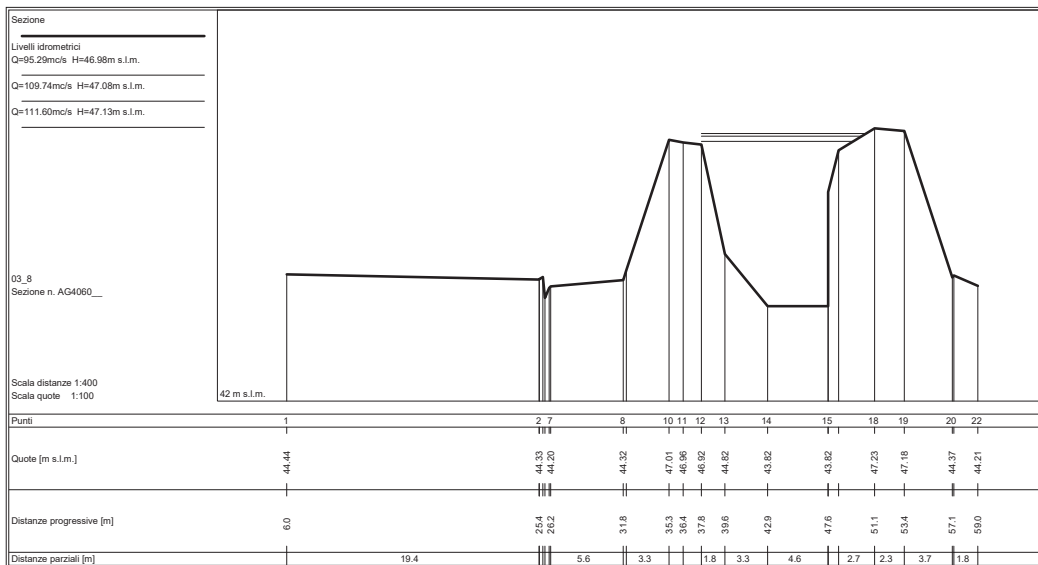
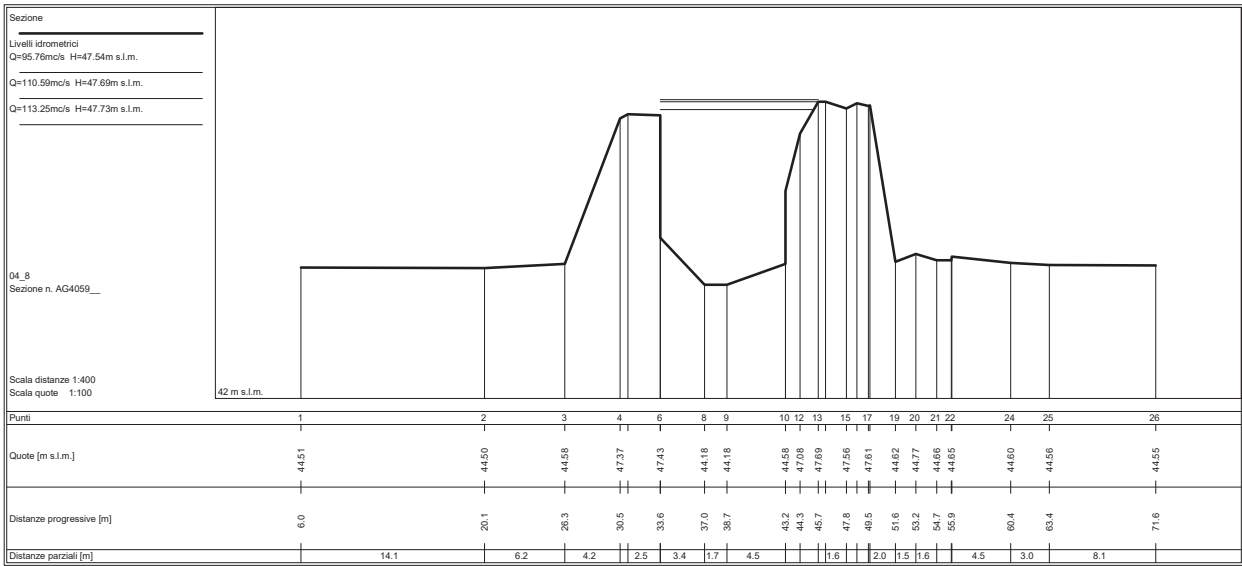

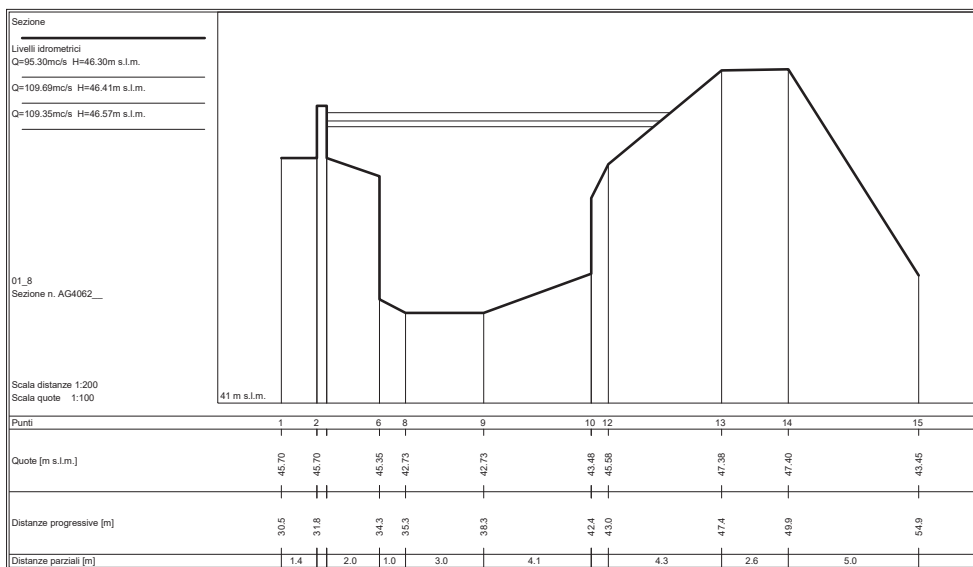
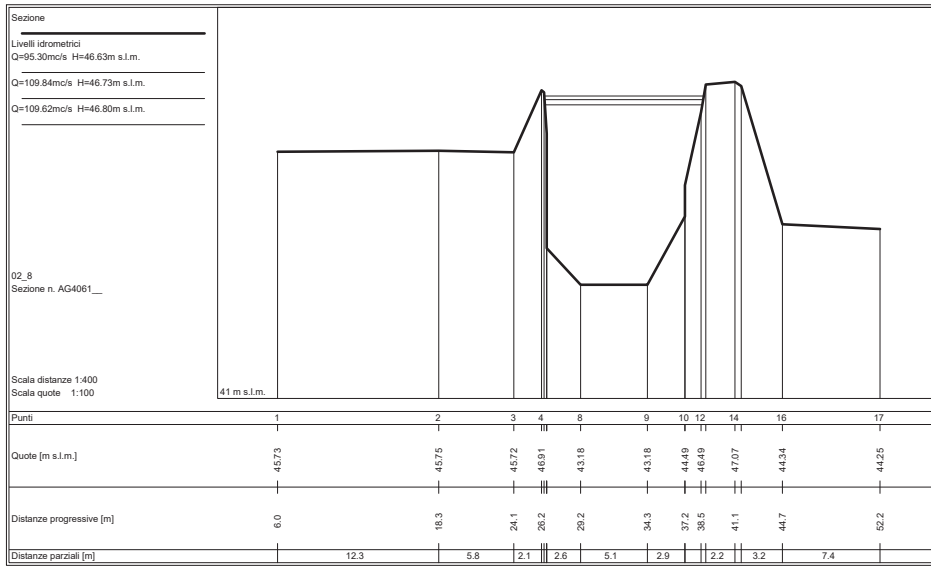

SEZIONI FLUVIALI  
FOSSO AGNACCINO - TRATTO 1

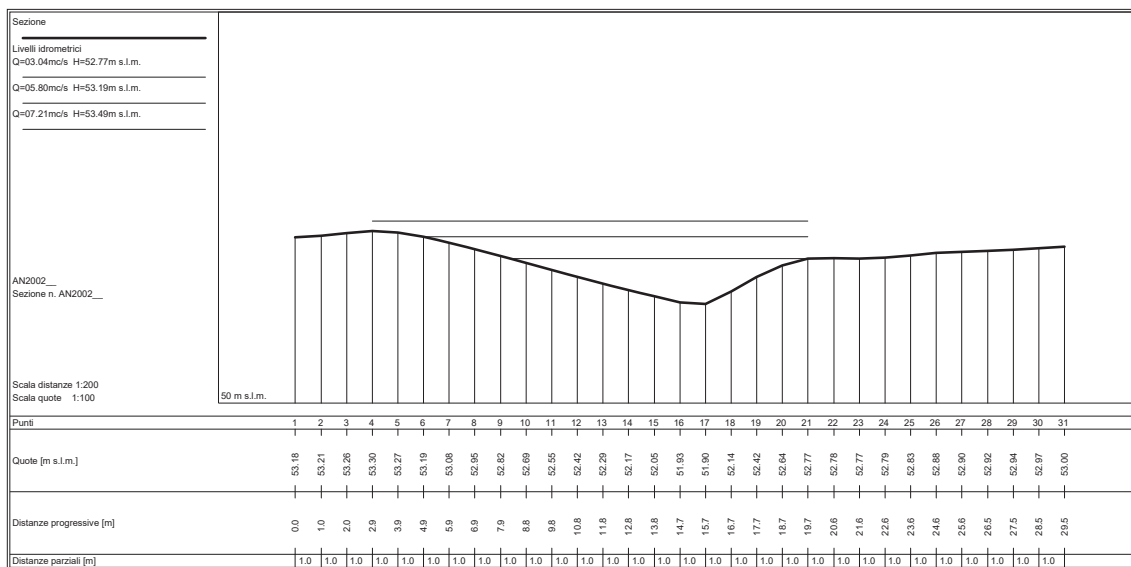
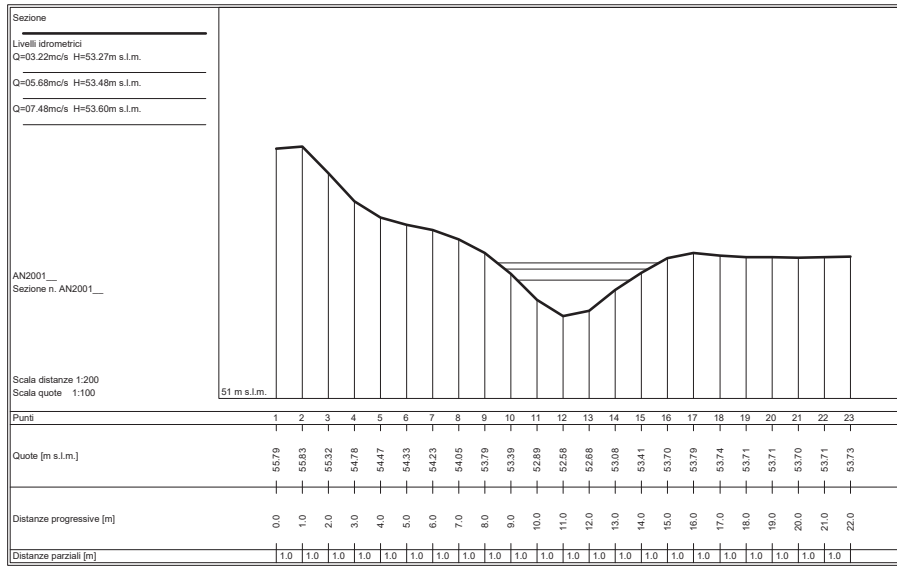

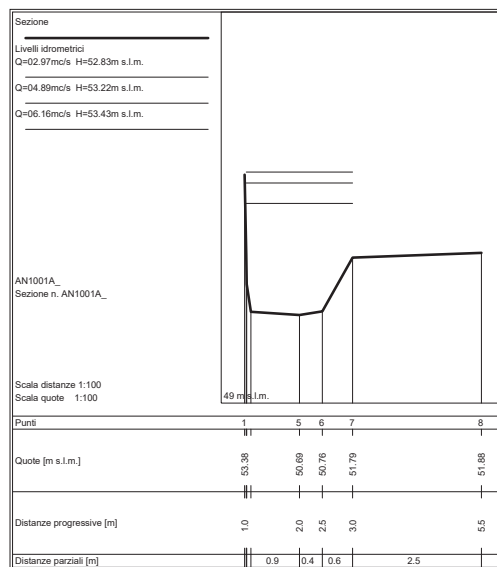
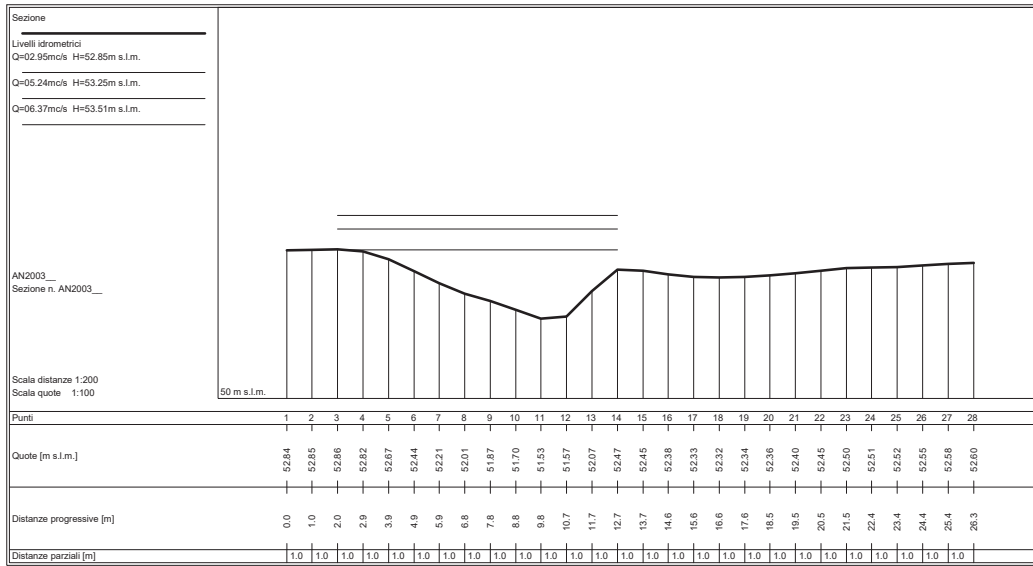

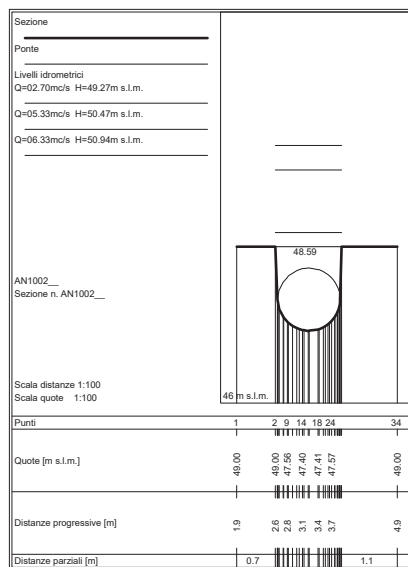
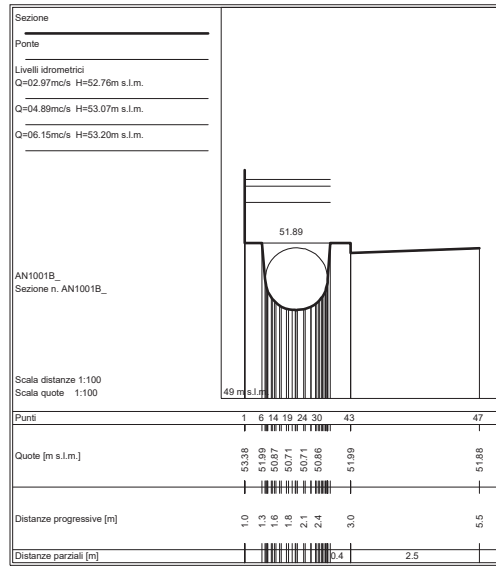



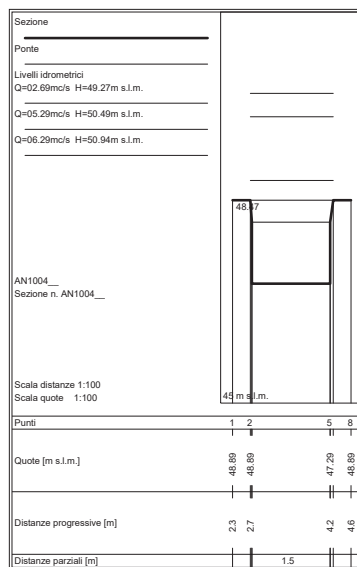
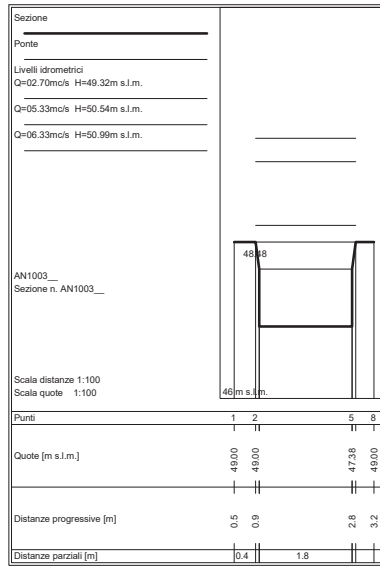

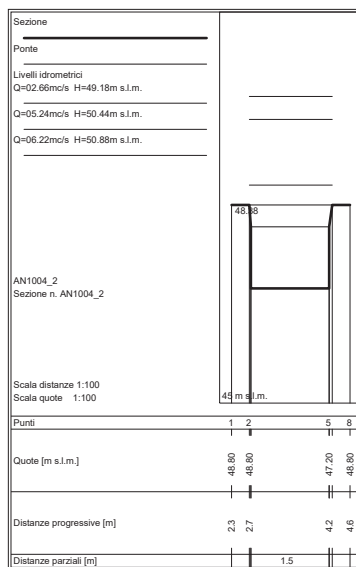
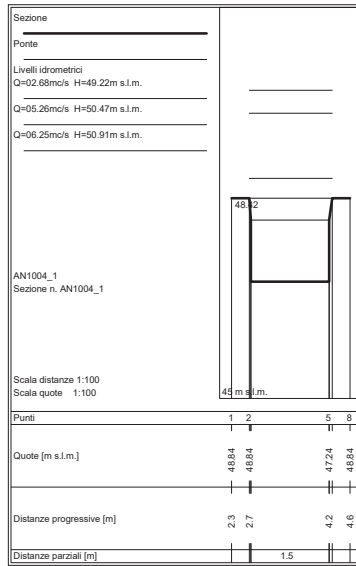

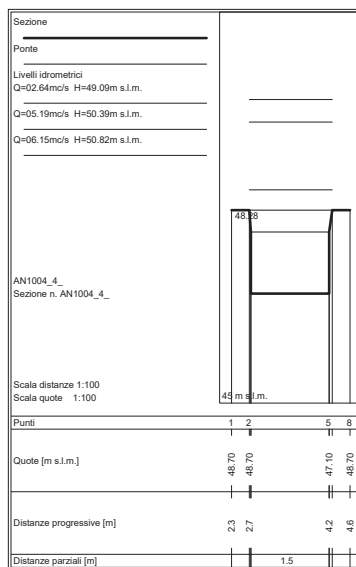
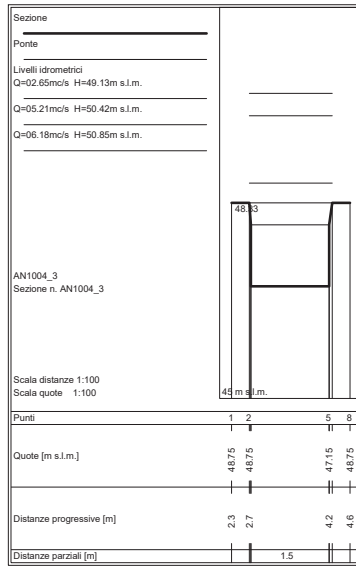

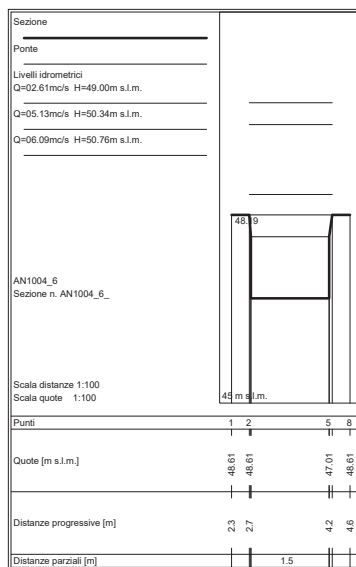
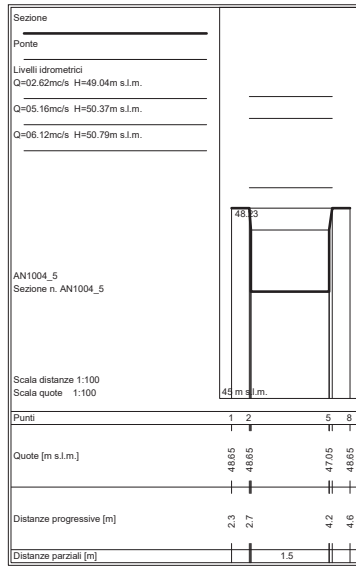

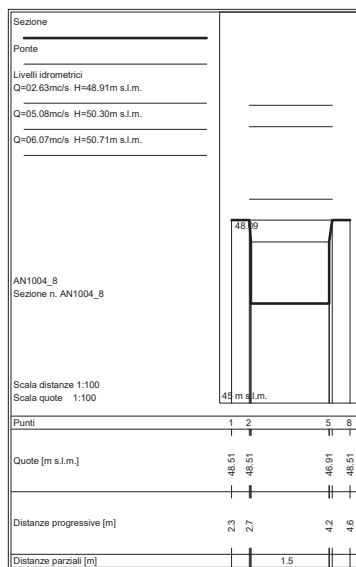
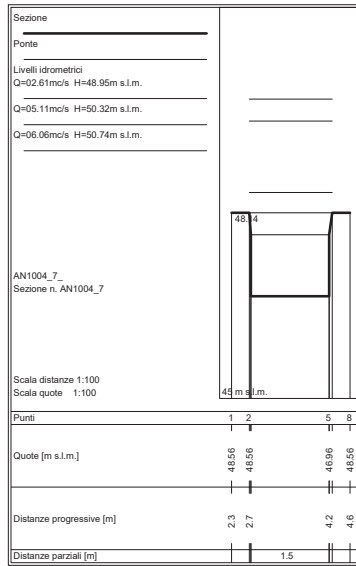

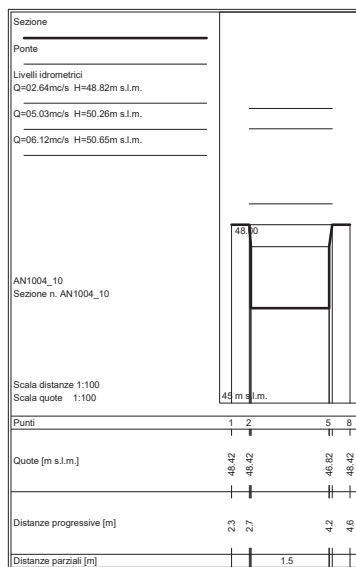
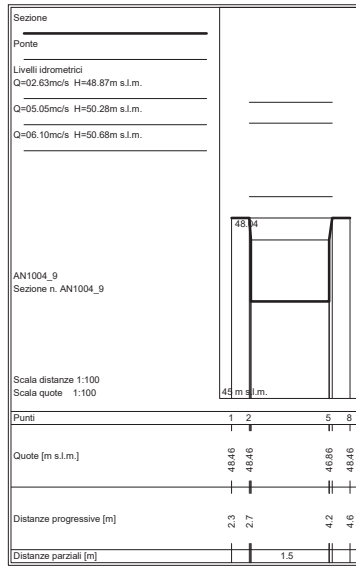

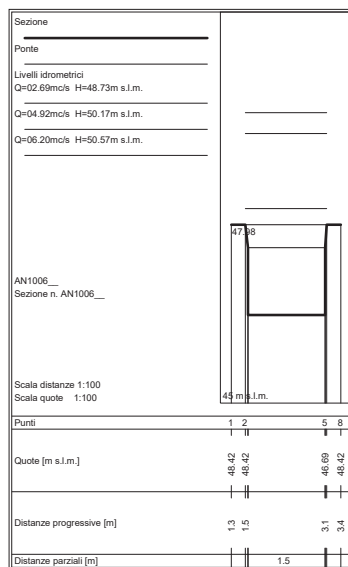
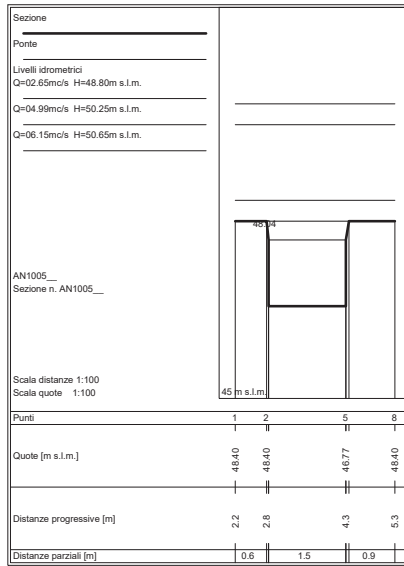

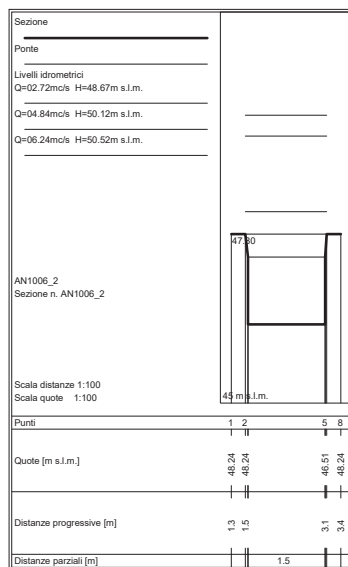
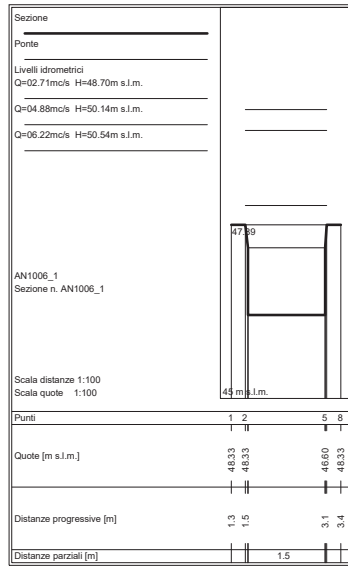



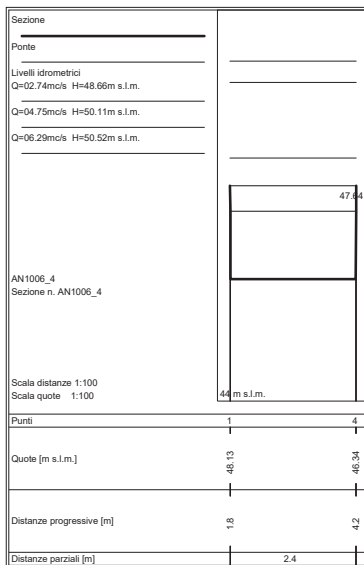
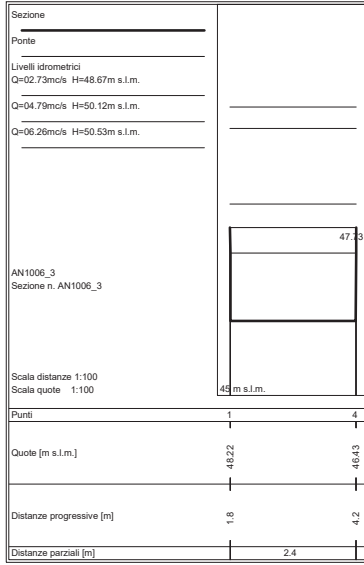

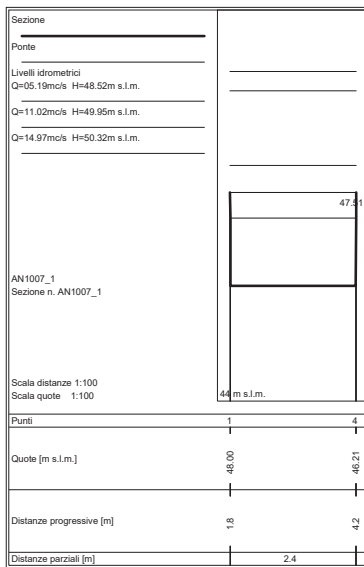
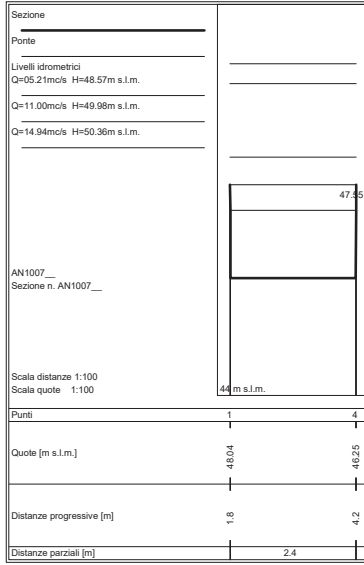

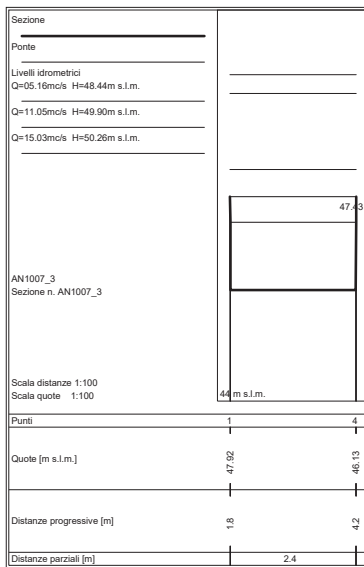
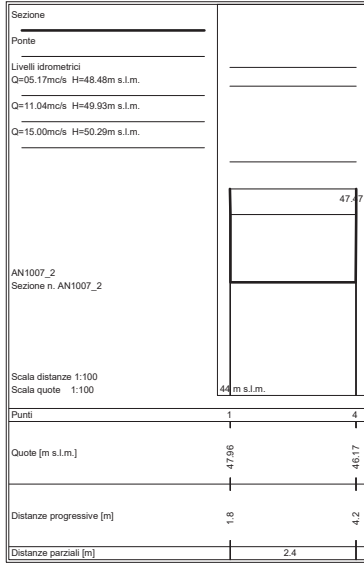

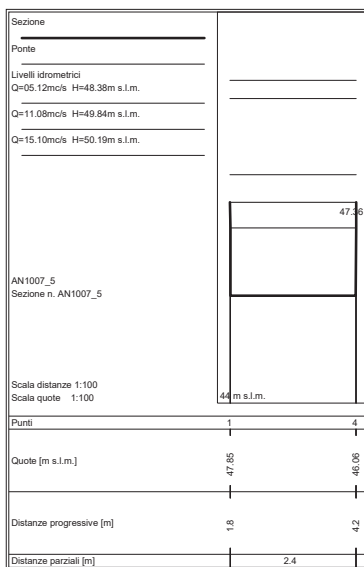
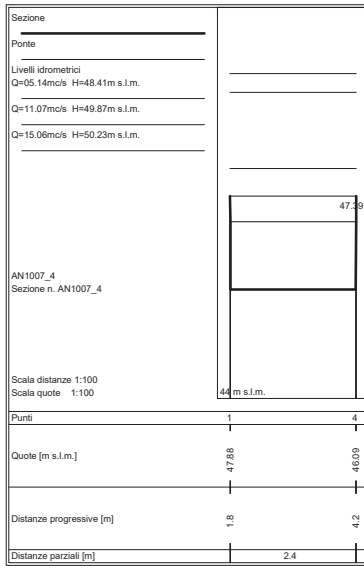

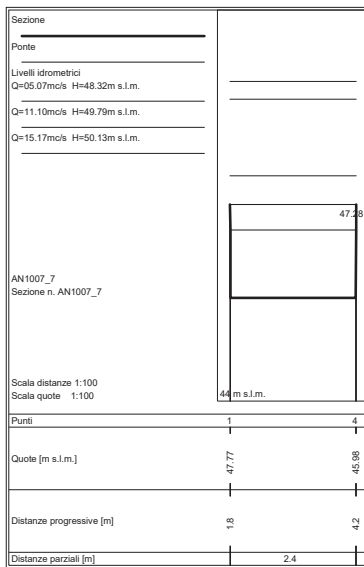
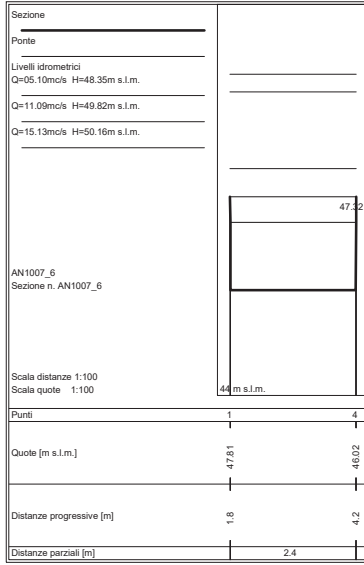

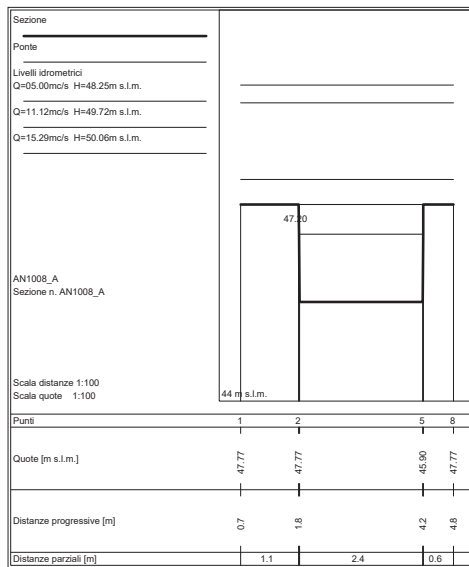
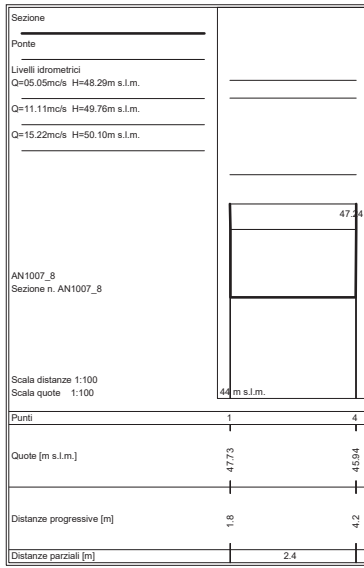

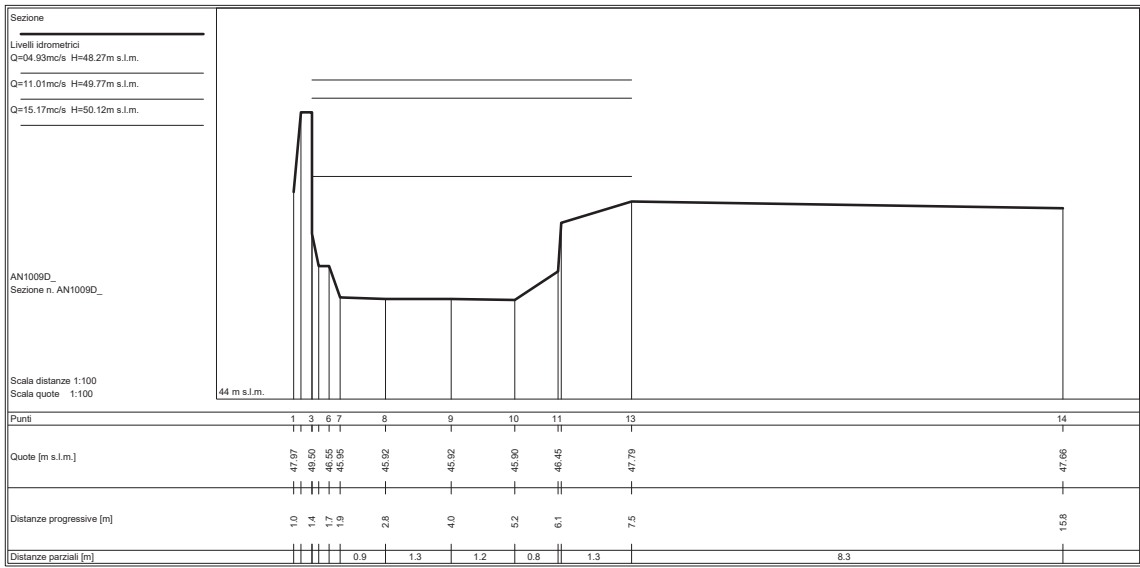
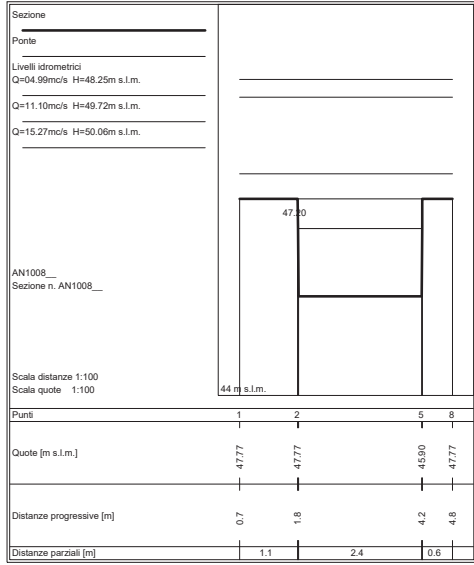

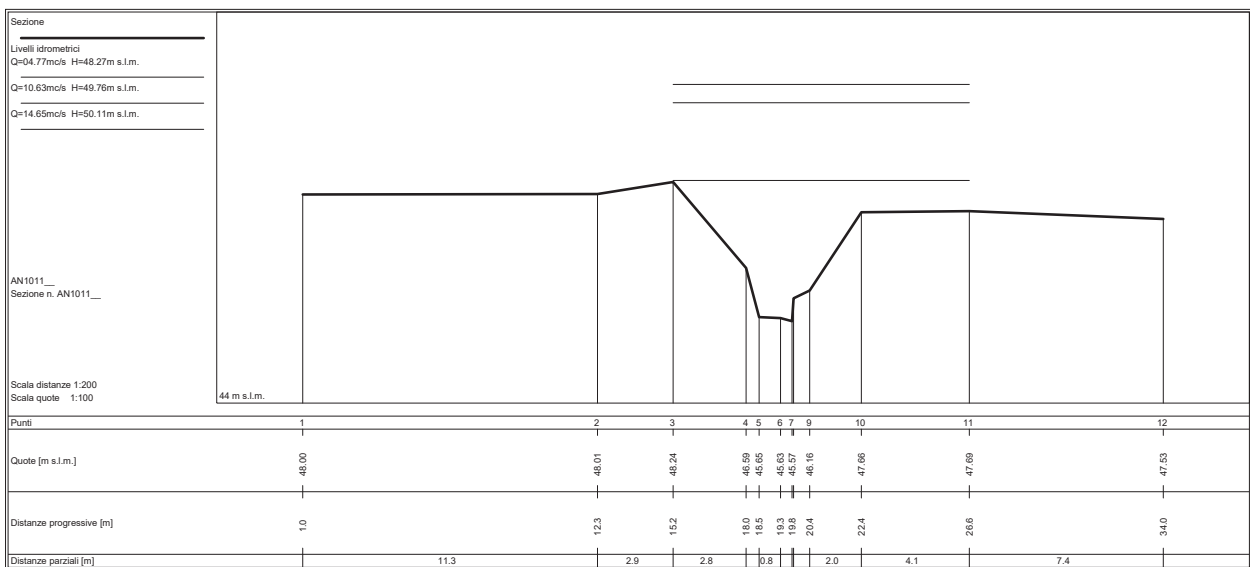
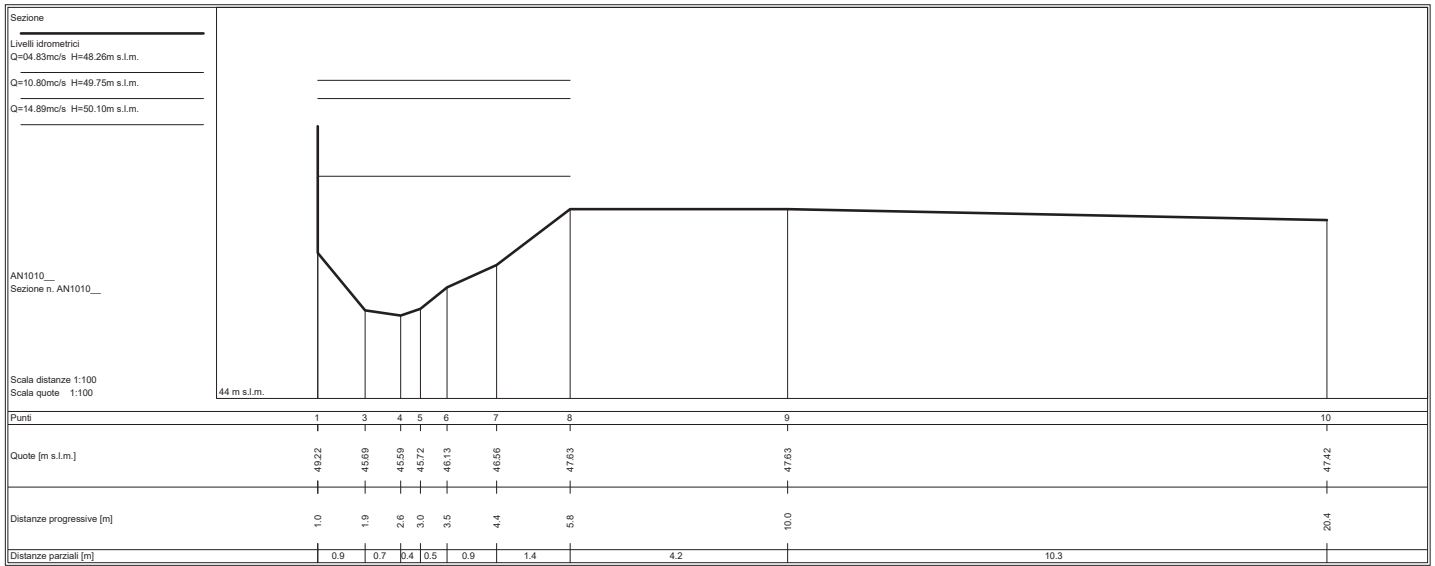



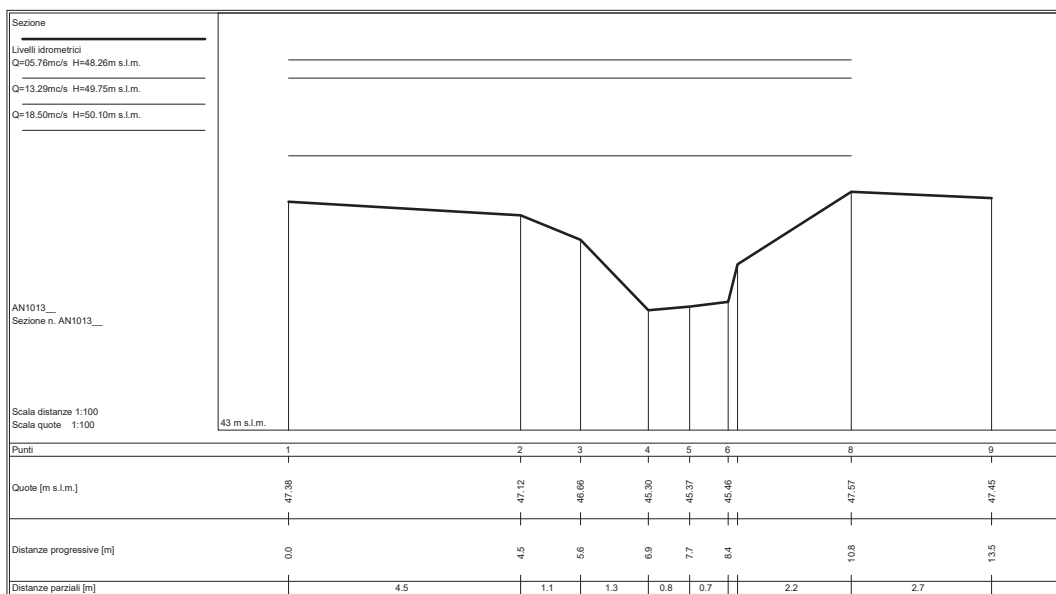
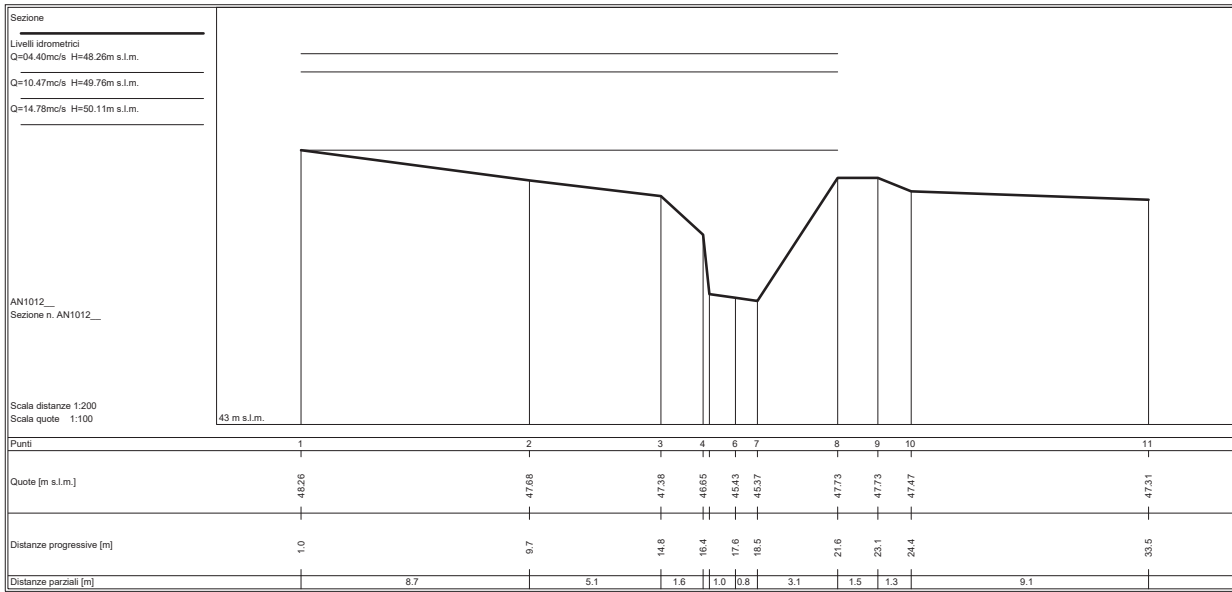

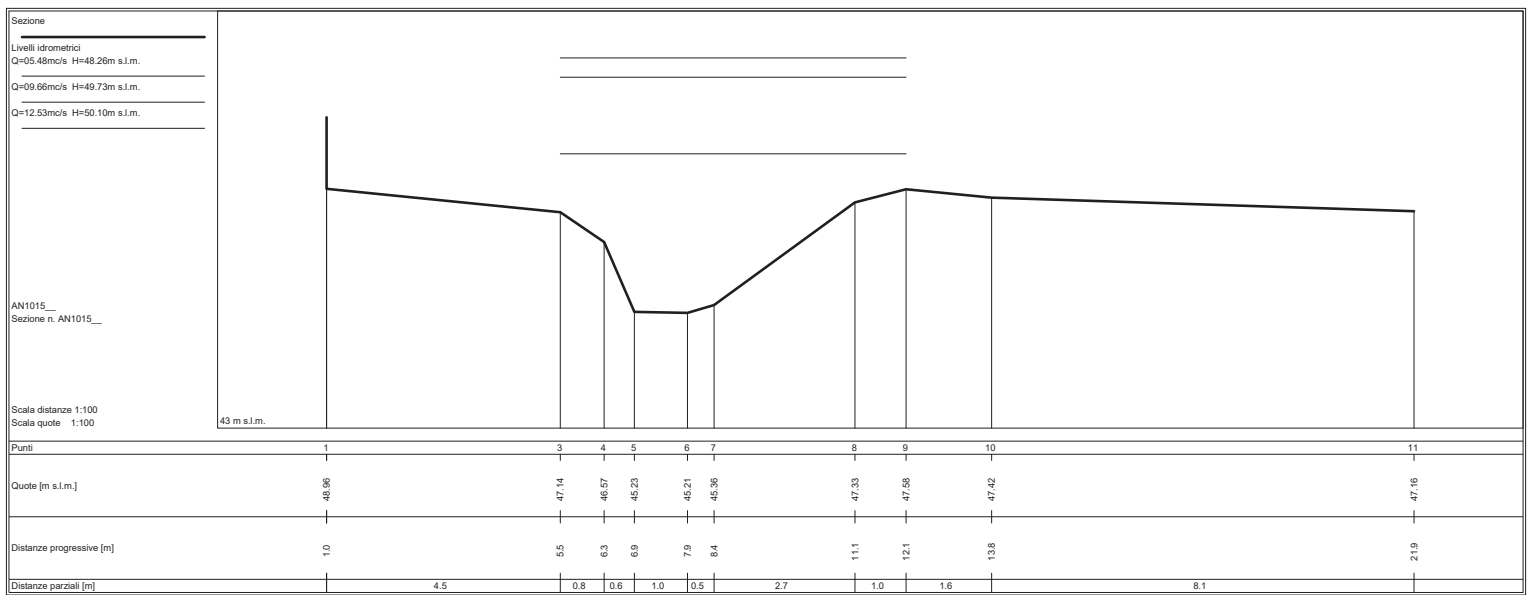
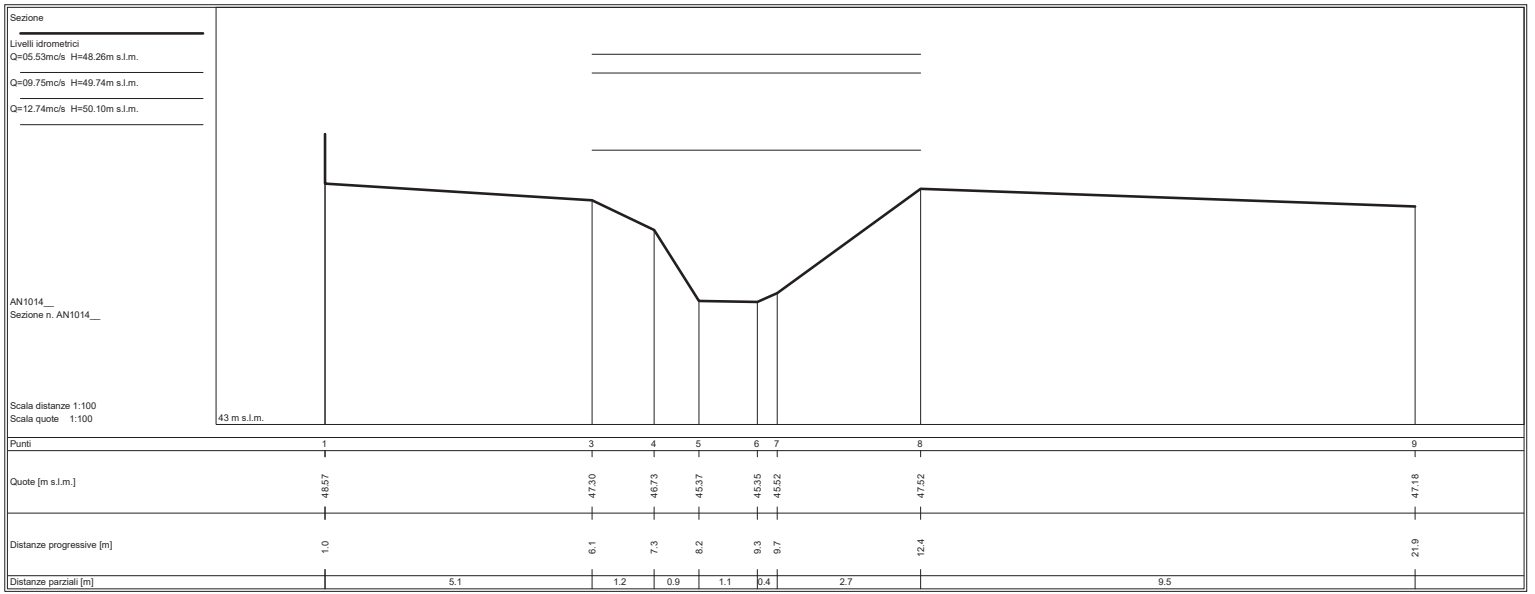

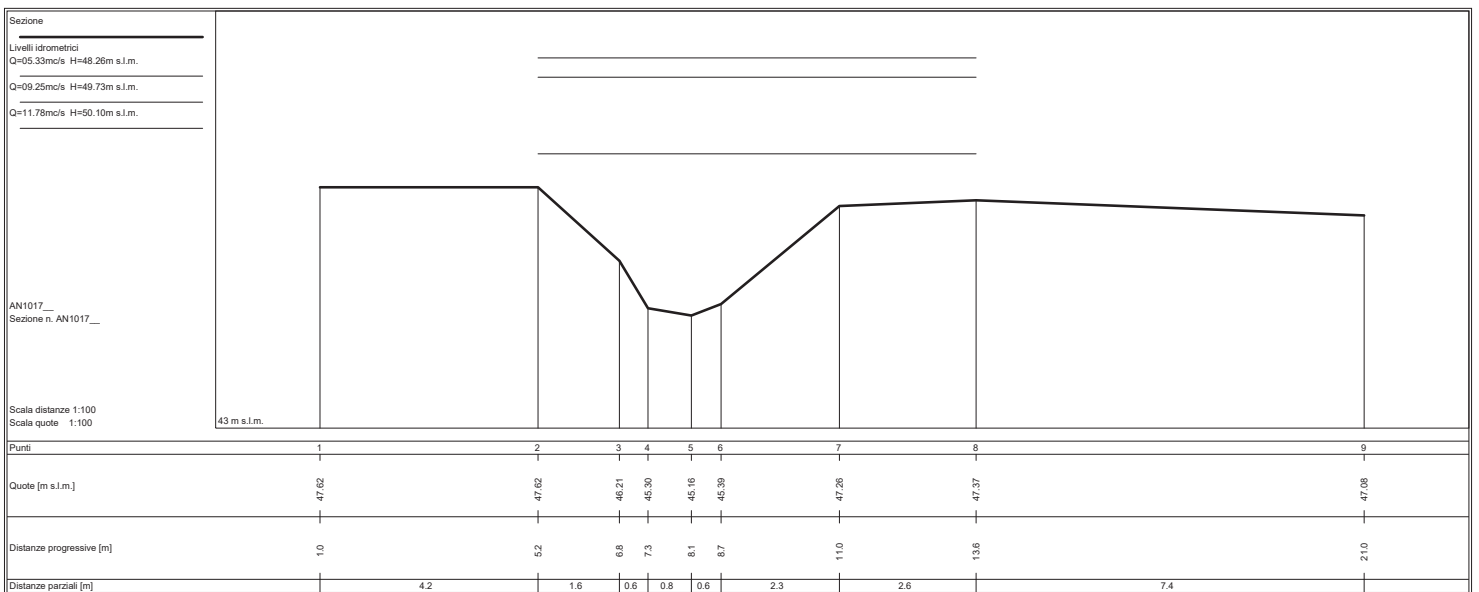
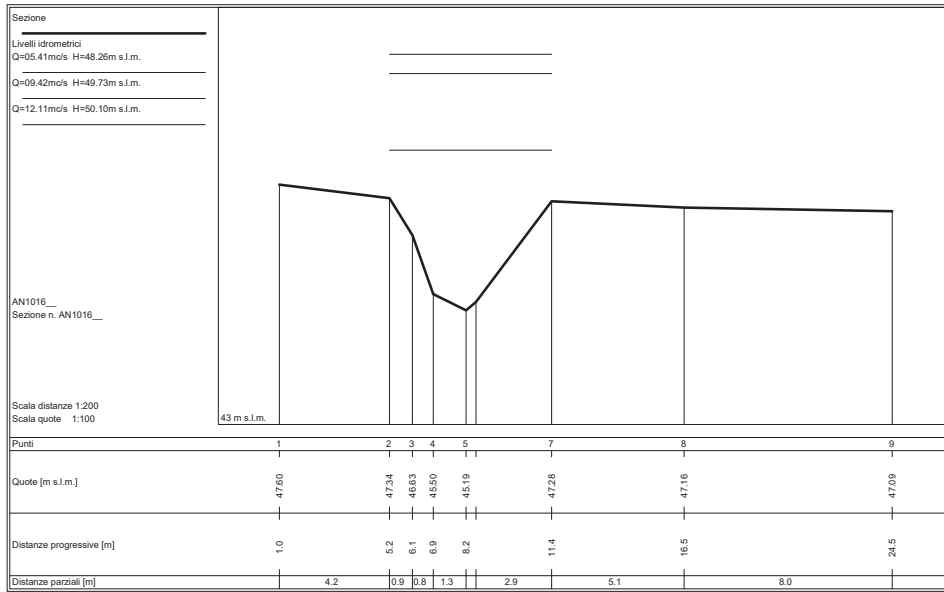

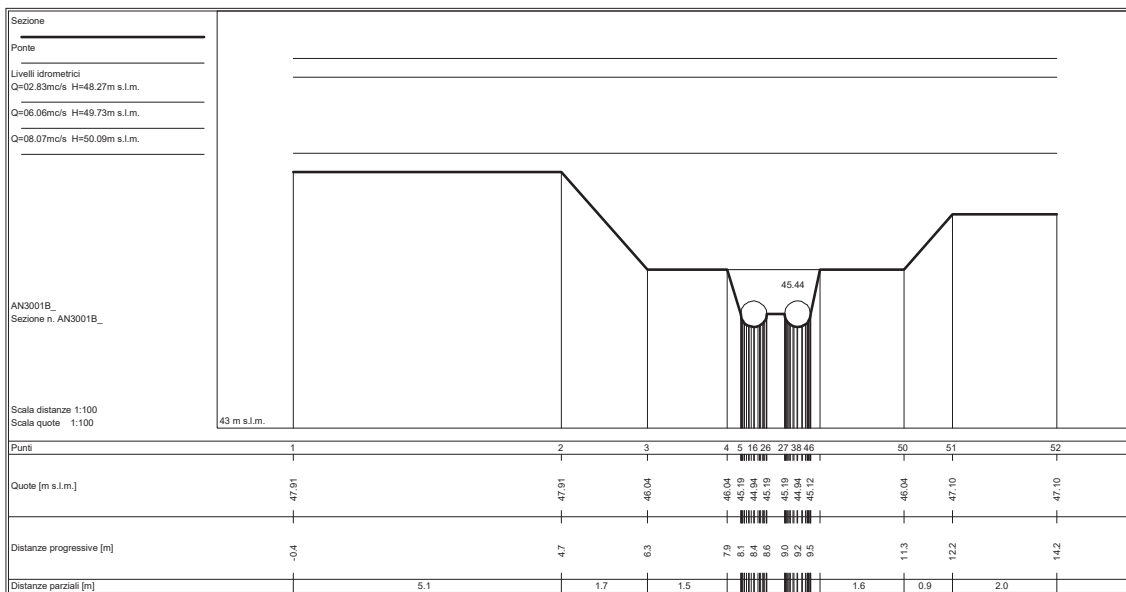
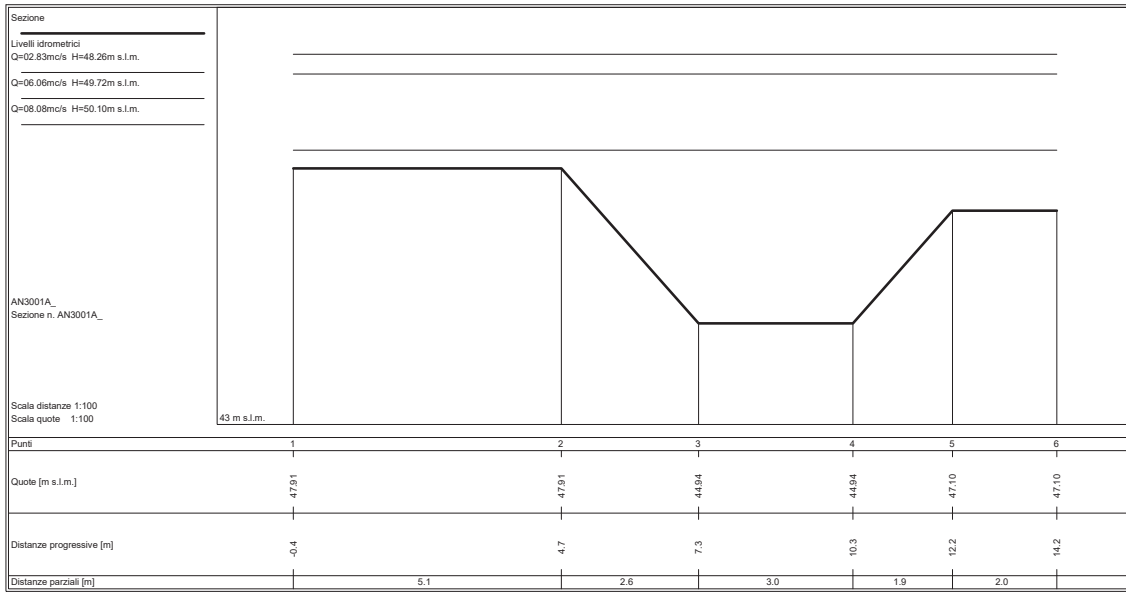

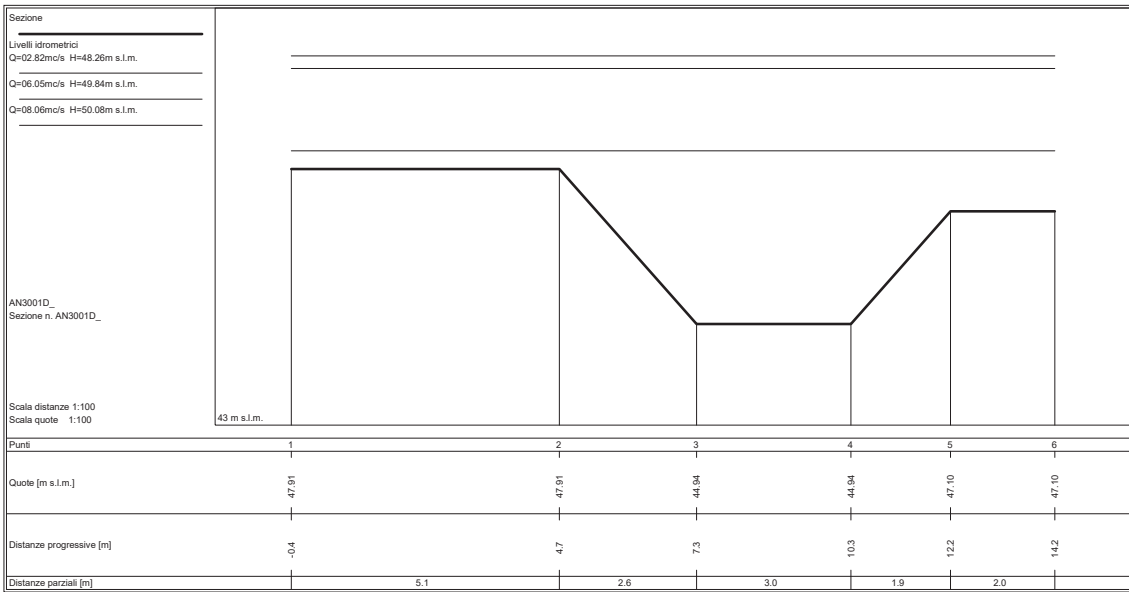
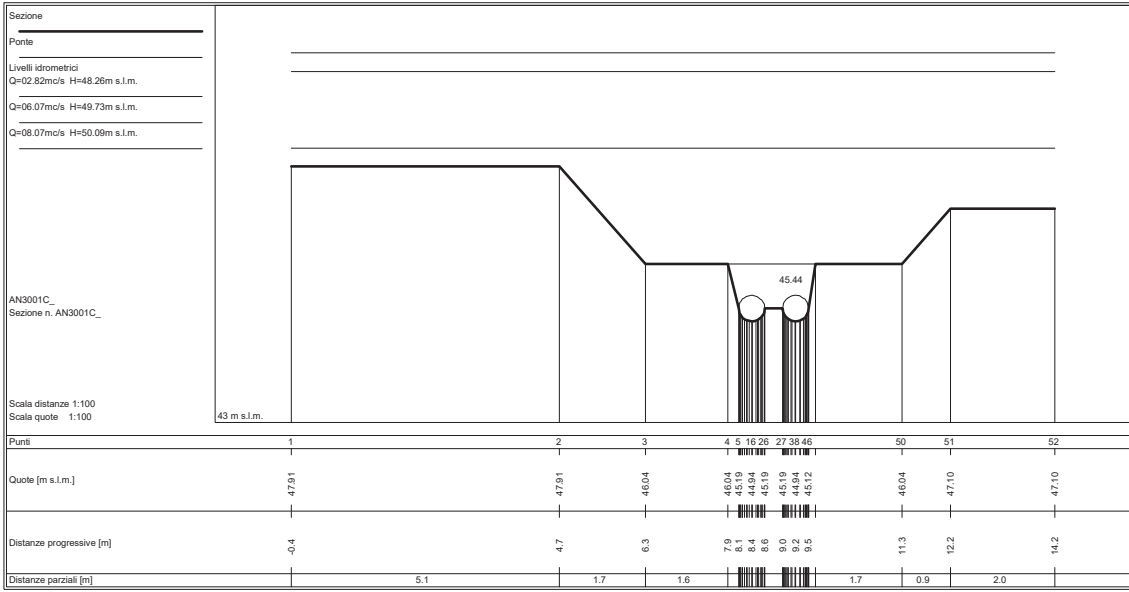

Sezione

Livelli idrometrici

Q=02.68mc/s H=48.26m s.l.m.

Q=05.36mc/s H=49.84m s.l.m.

Q=07.58mc/s H=50.08m s.l.m.

AN1018\_\_  
Sezione n. AN1018\_\_

Scala distanze 1:100  
Scala quote 1:100

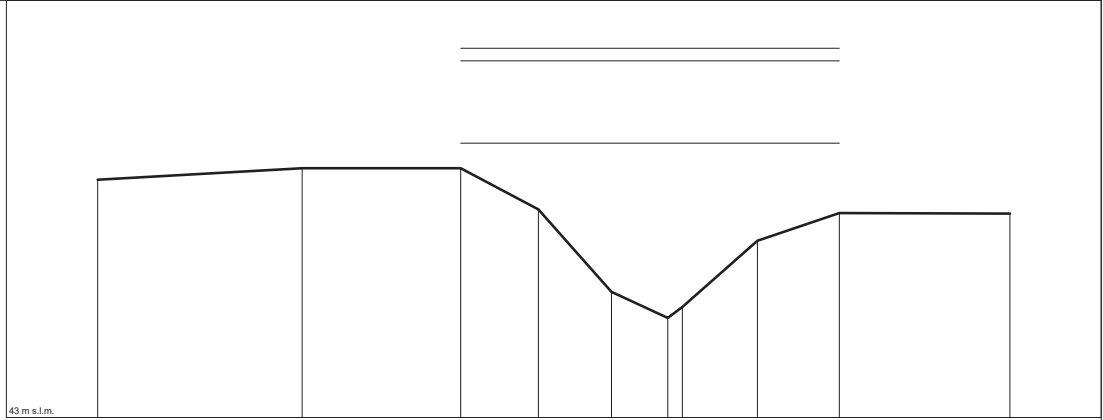

Punti	1	2	3	4	5	6	7	8	9	10
Quote [m s.l.m.]	47.56	47.79	47.79	46.99	45.41	44.91	45.12	46.40	46.93	46.91
Distanze progressive [m]	1.0	4.9	8.0	9.5	10.8	11.9	12.2	13.7	16.2	18.5
Distanze parziali [m]		3.9	3.0	1.5	1.4	1.1	0.3	1.4	1.6	3.3

SEZIONI FLUVIALI  
FOSSO AGNACCINO - TRATTO 2

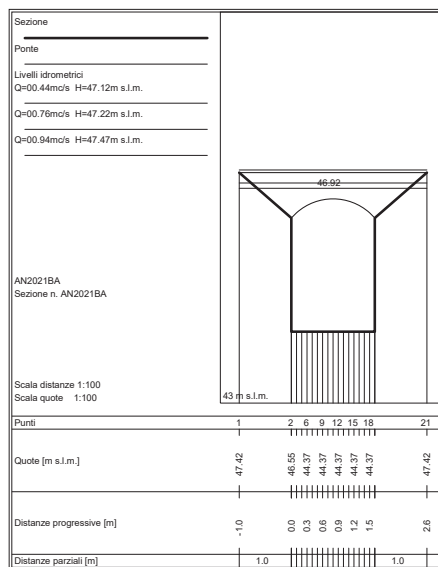
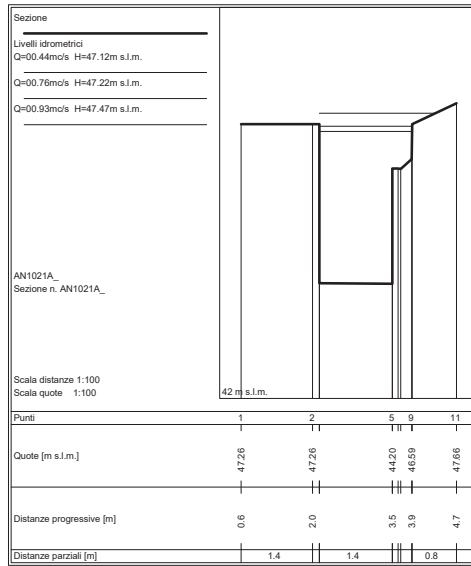



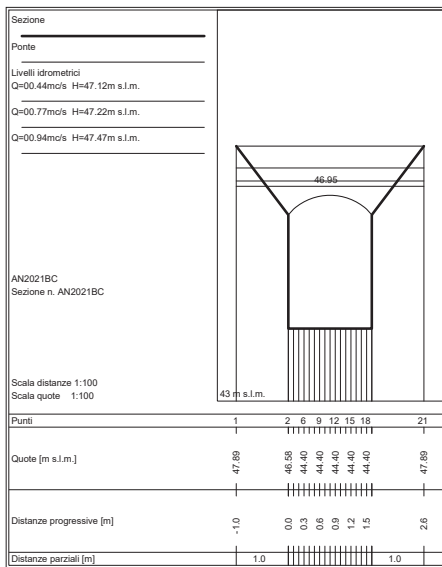
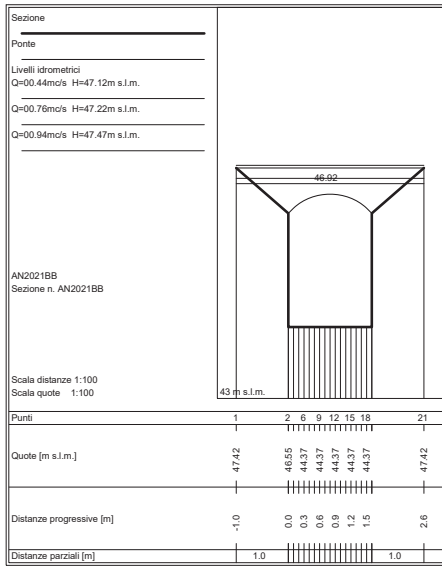

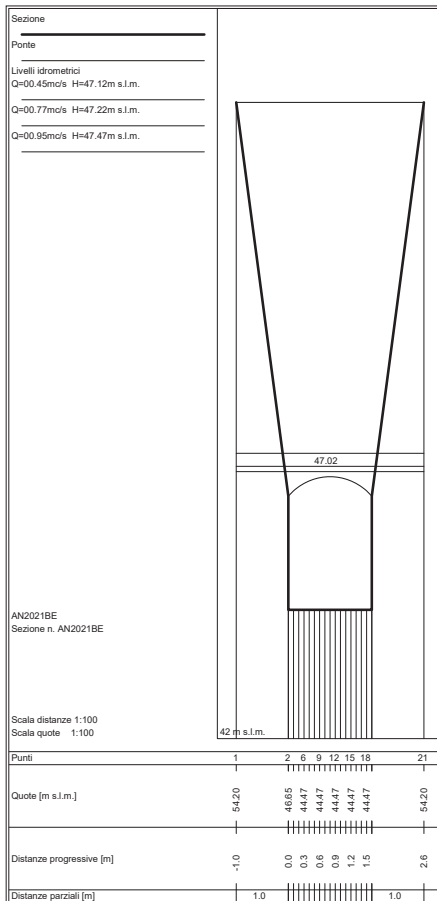
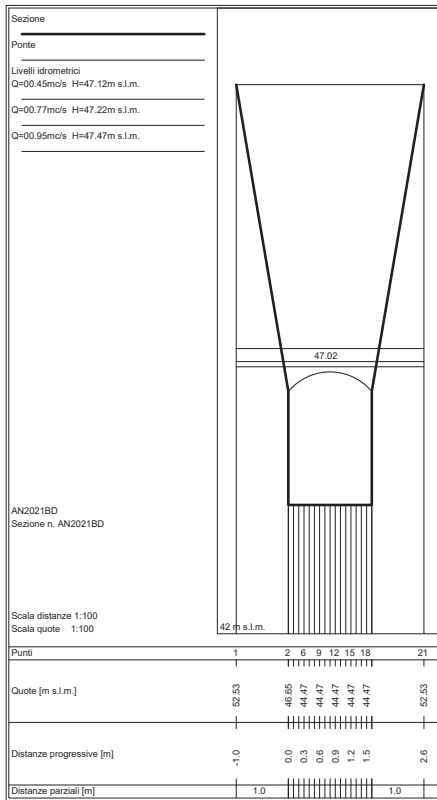

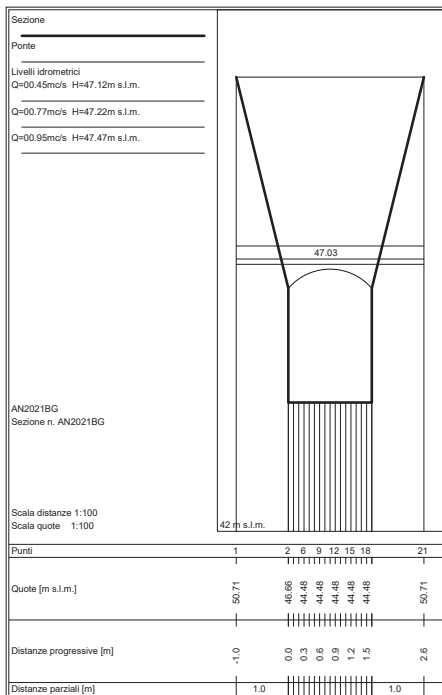
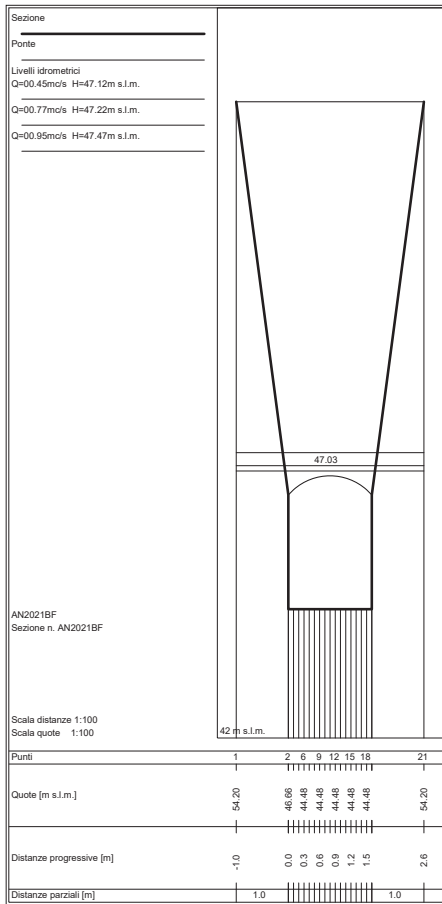

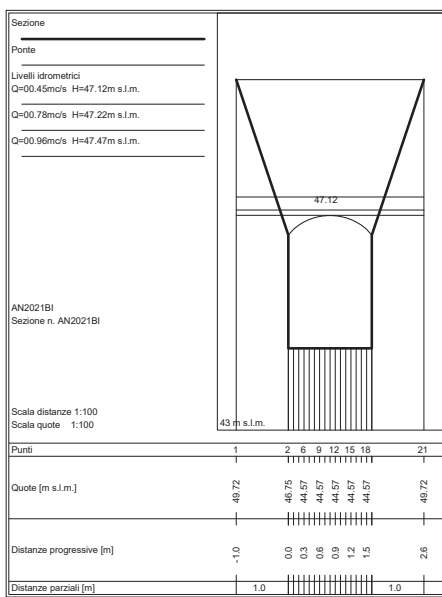
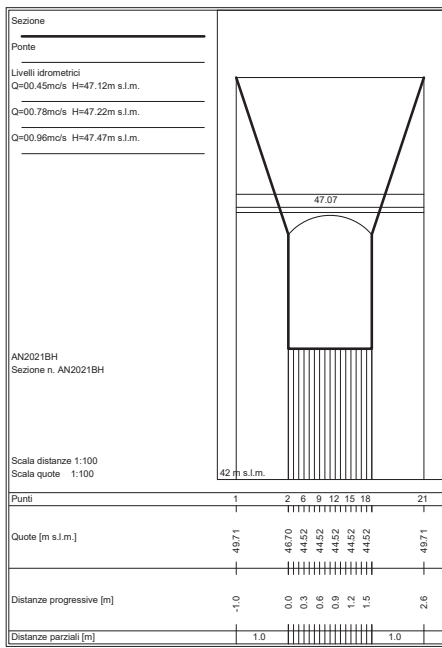

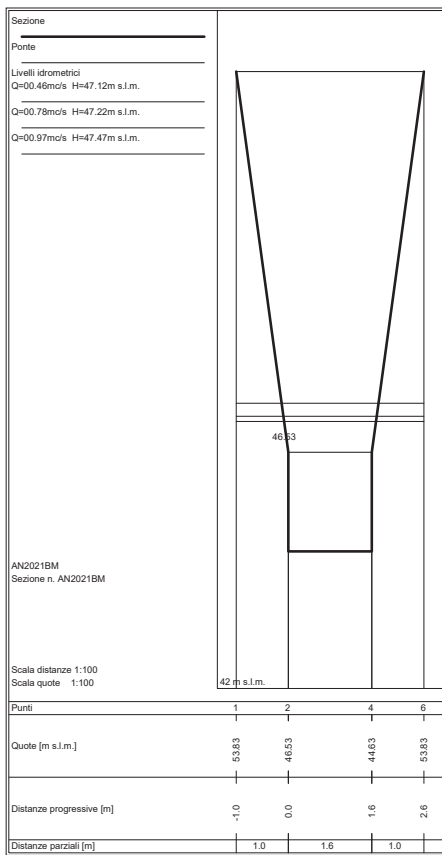
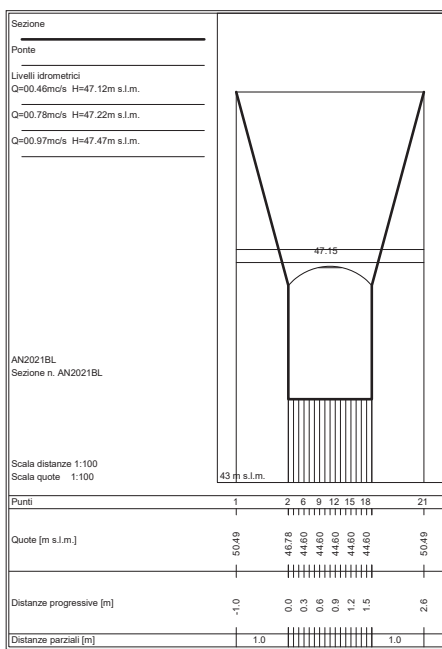

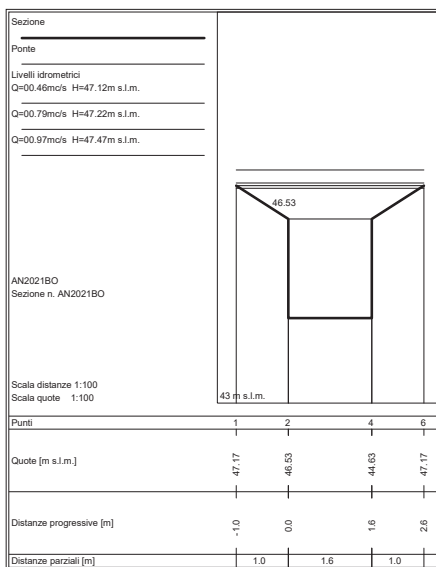
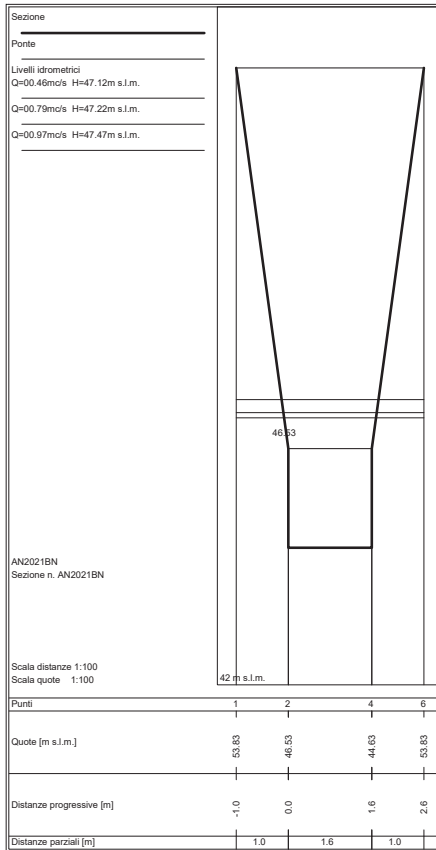

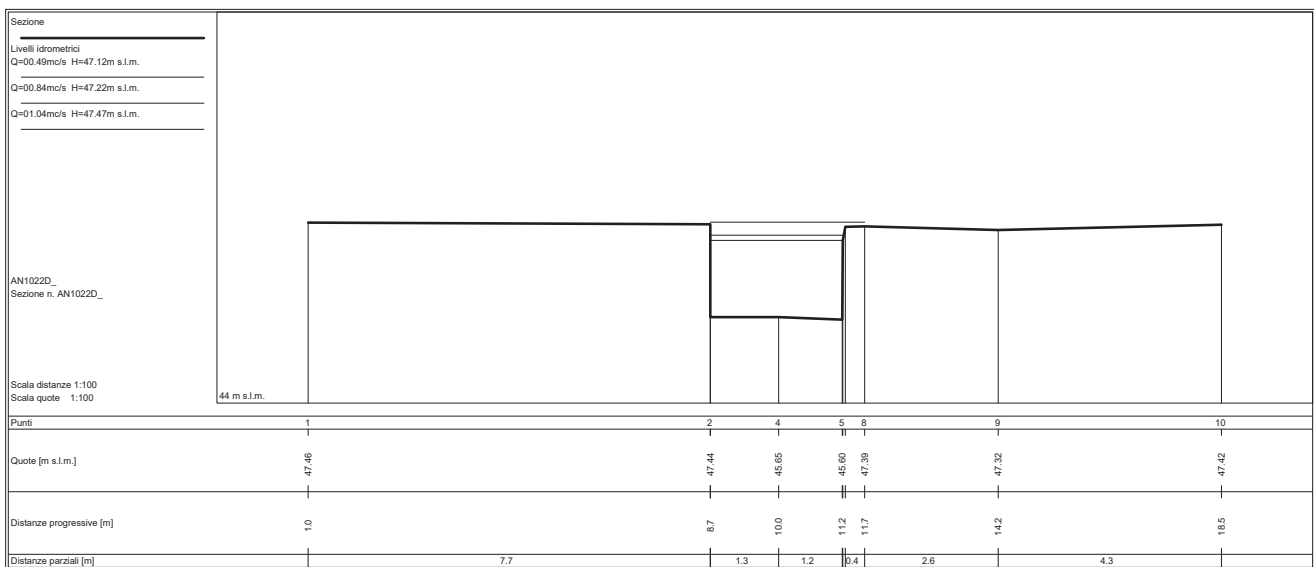
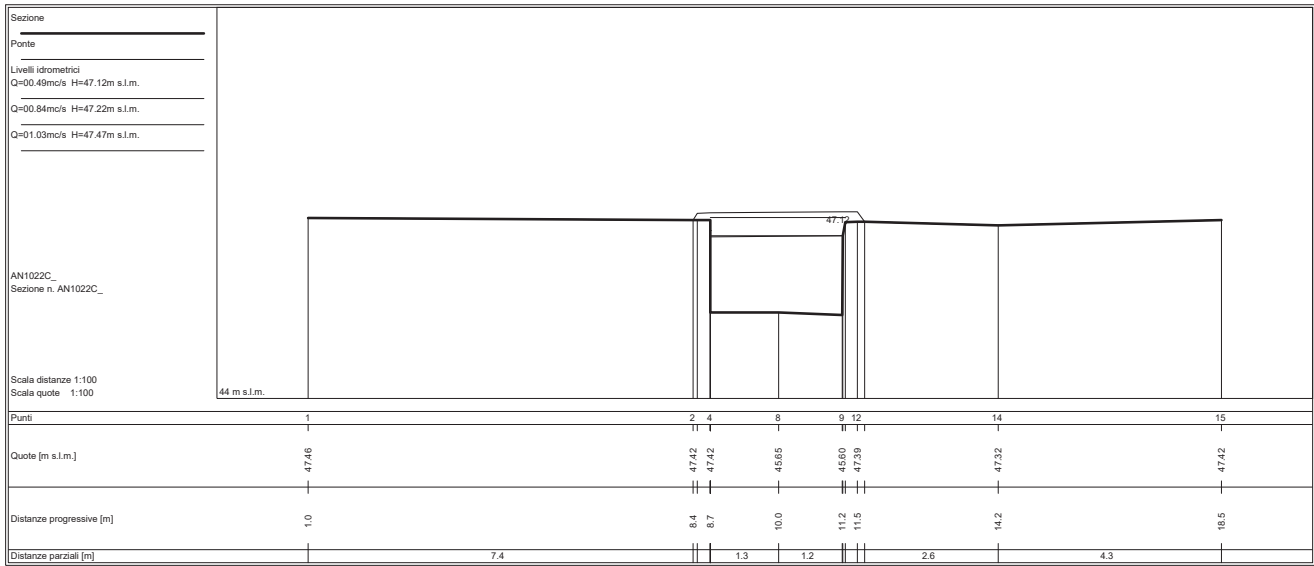

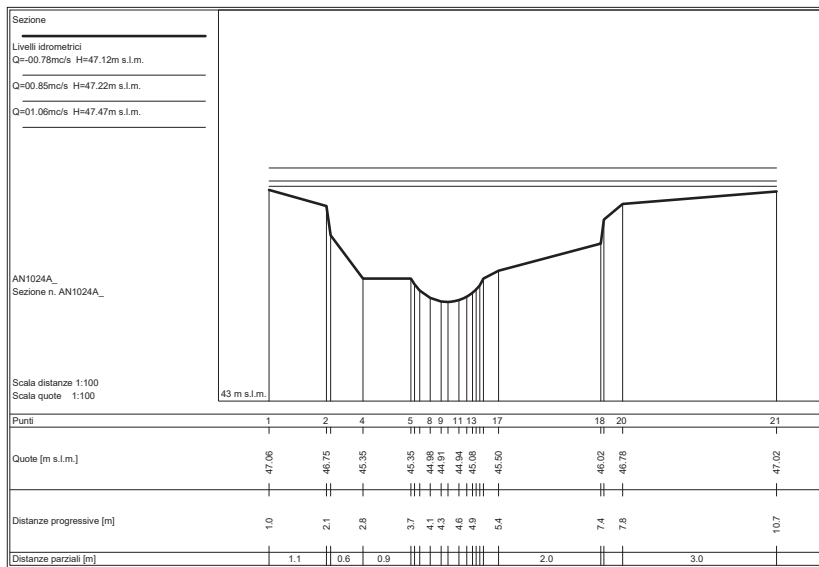
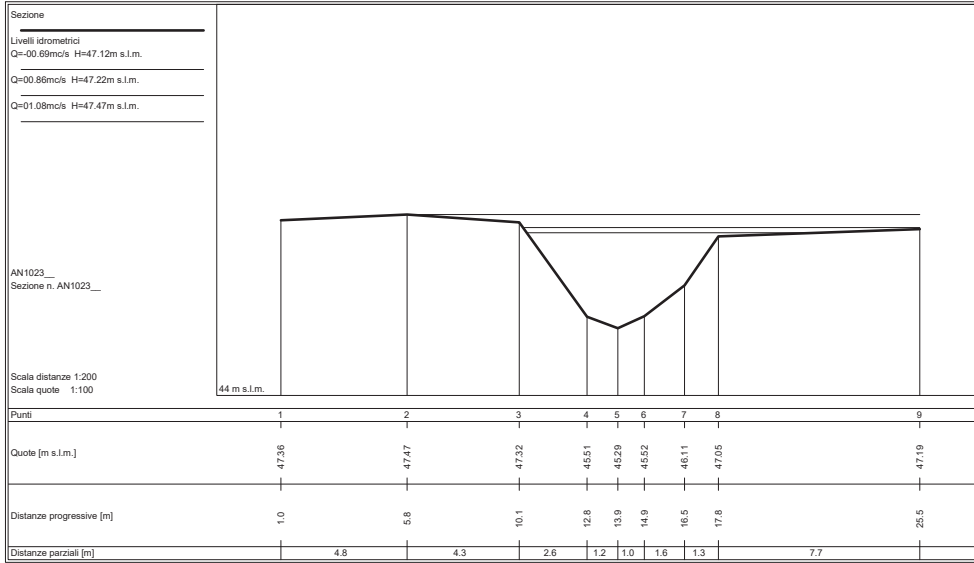



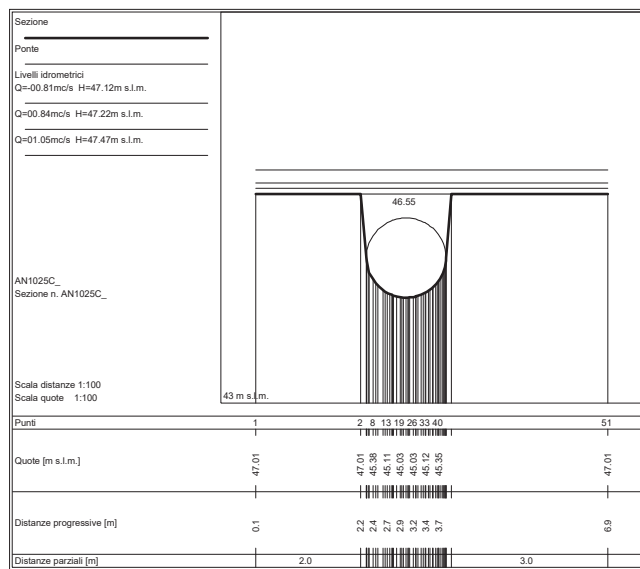
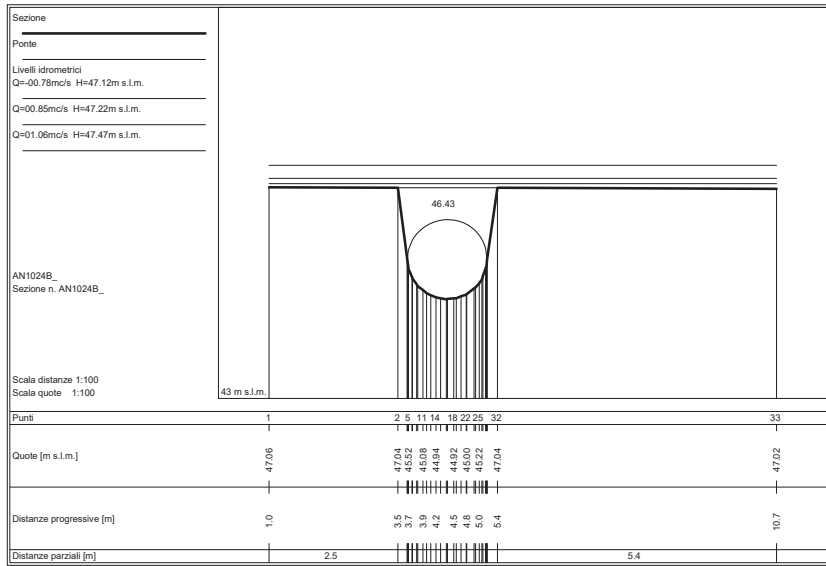

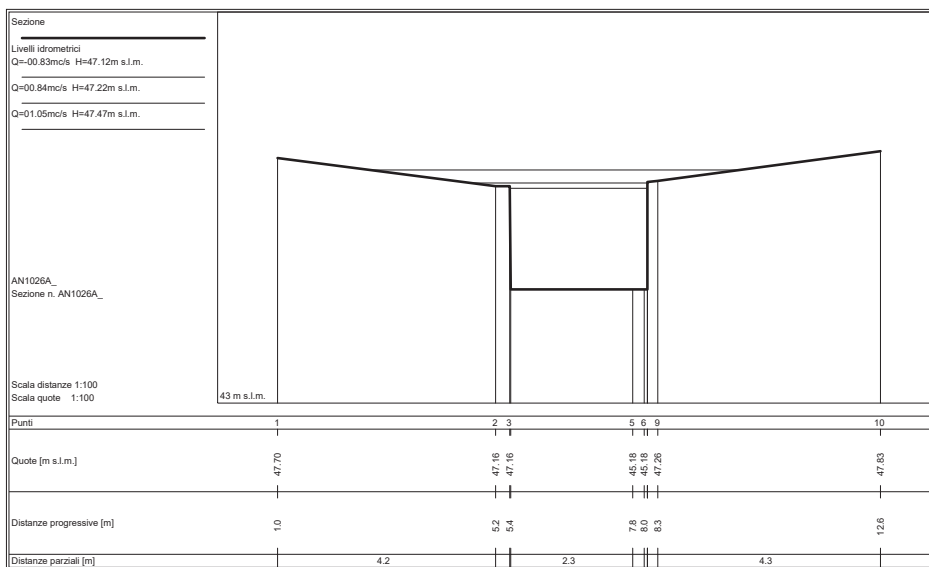
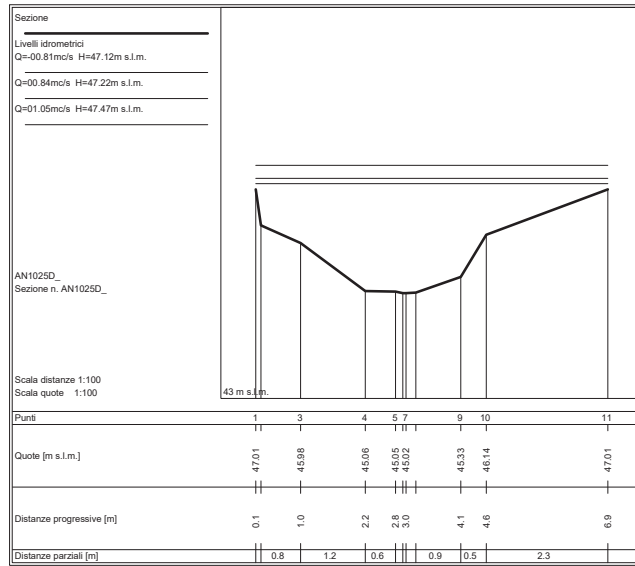

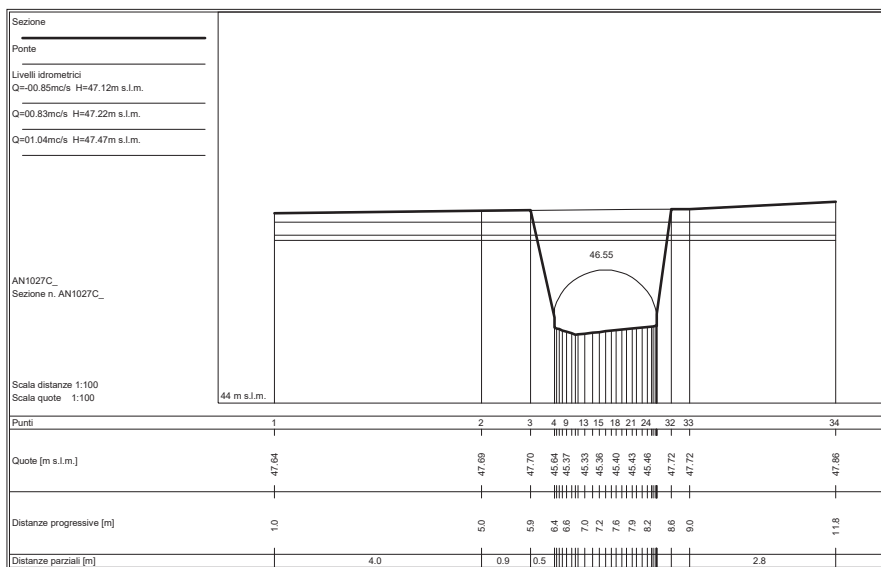
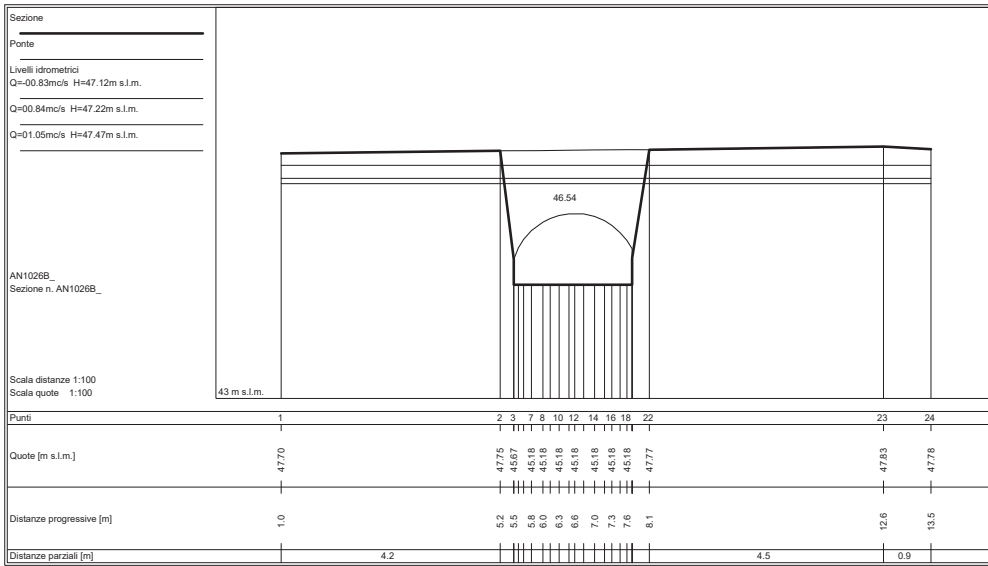

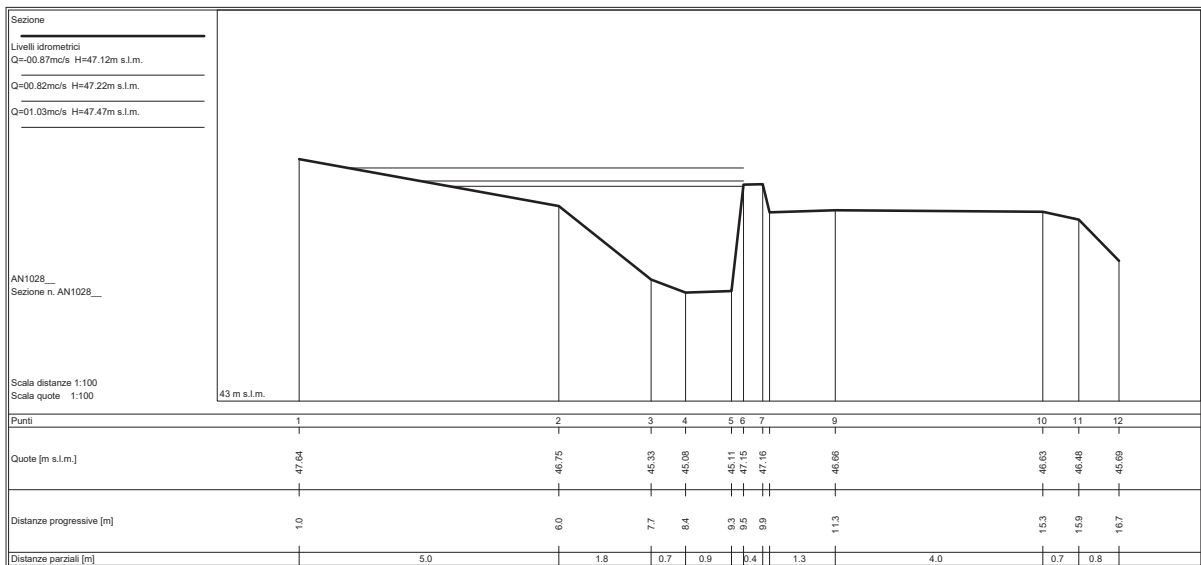
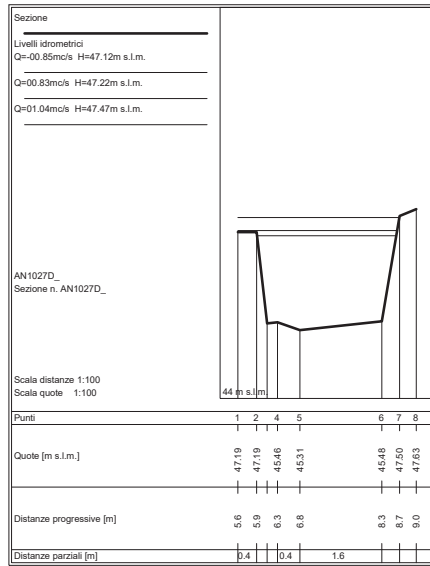

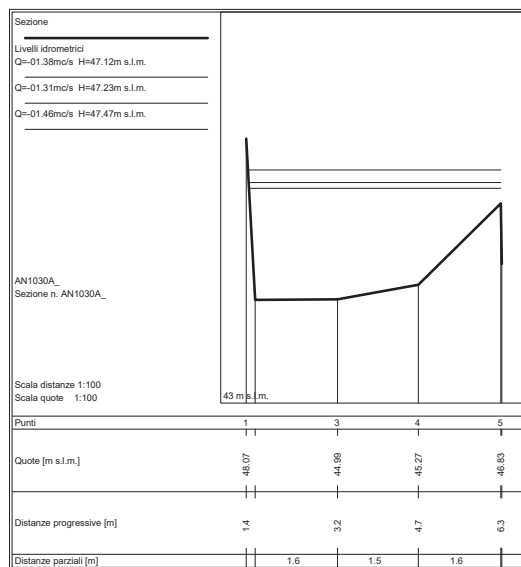
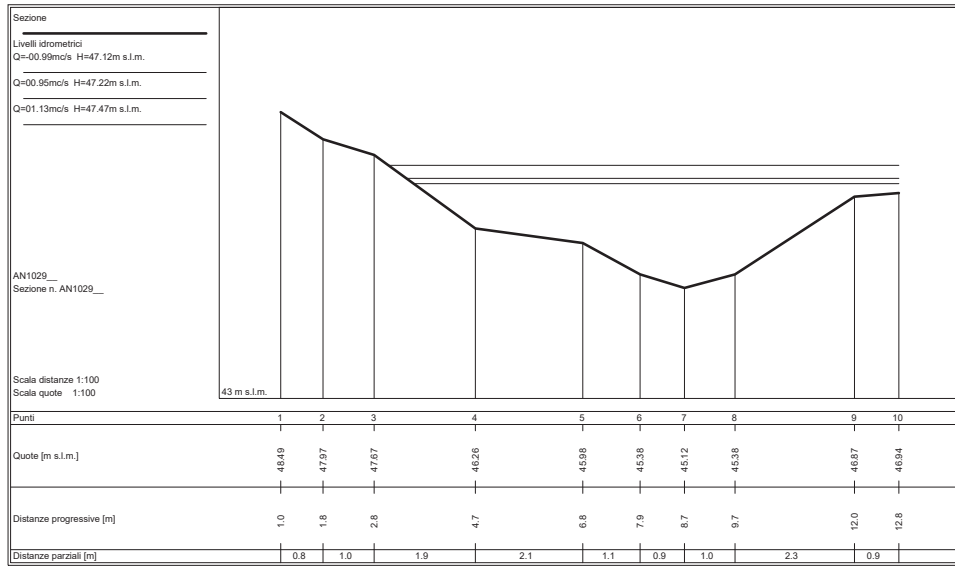

SEZIONI FLUVIALI  
FOSSO AGNACCINO - TRATTO 3

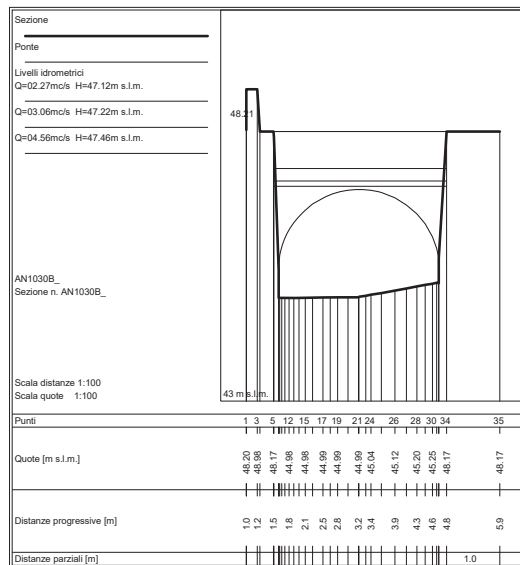
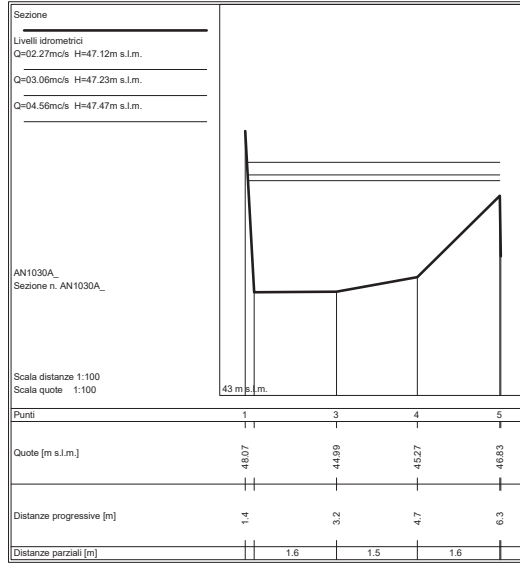

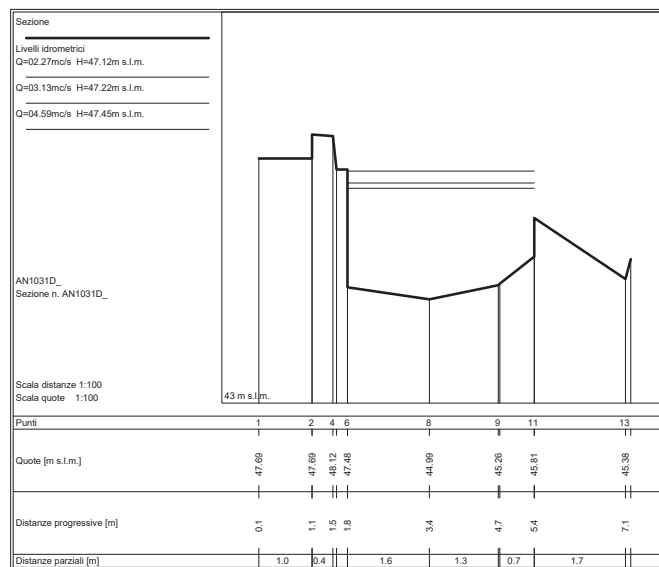
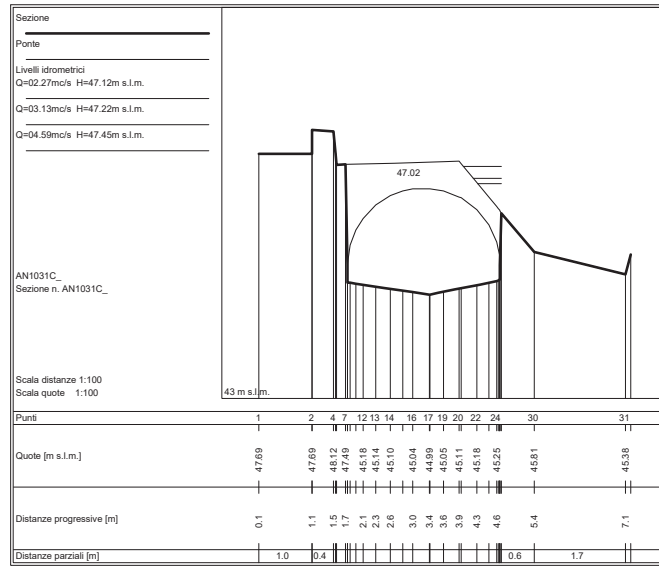



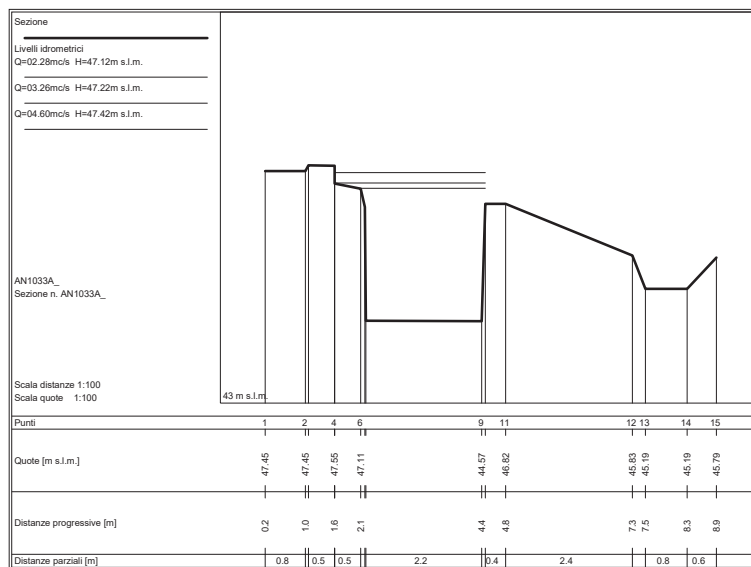
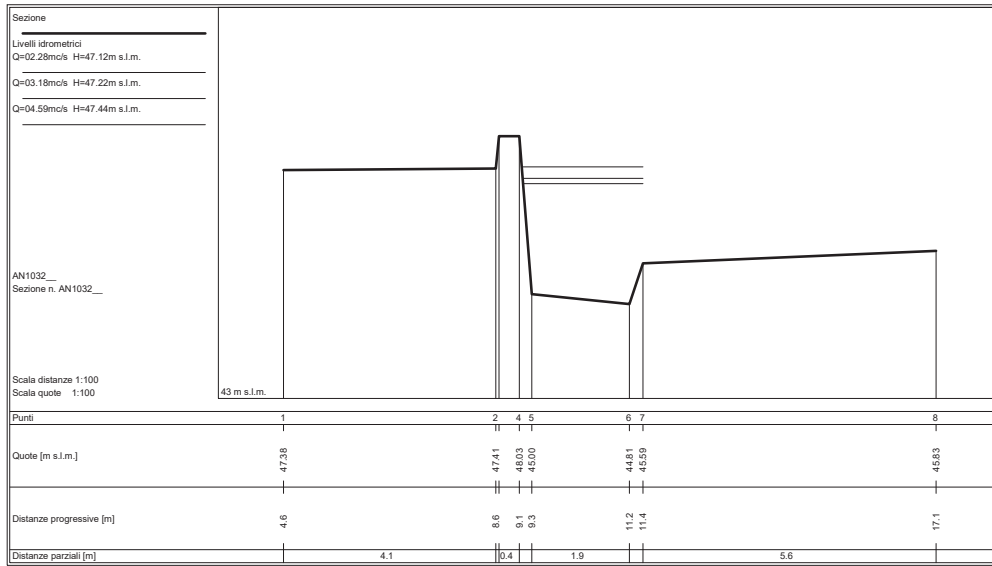

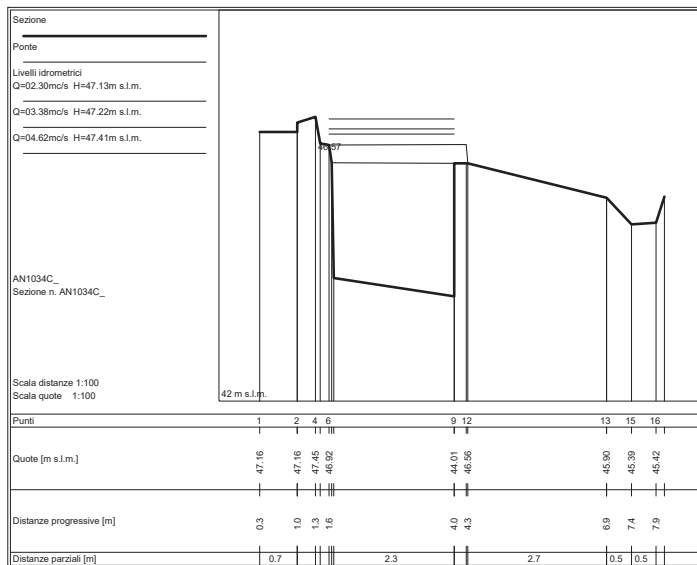
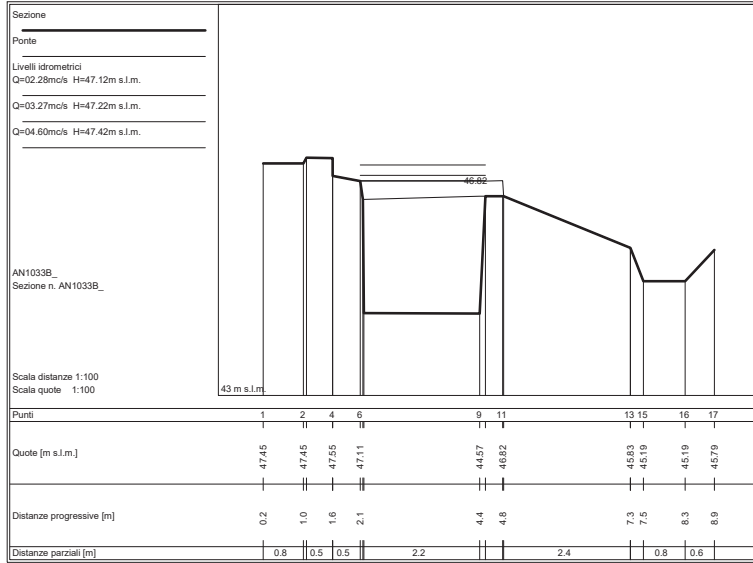

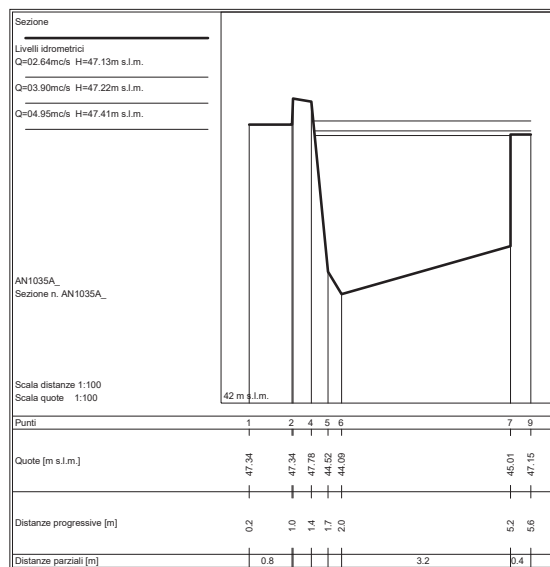
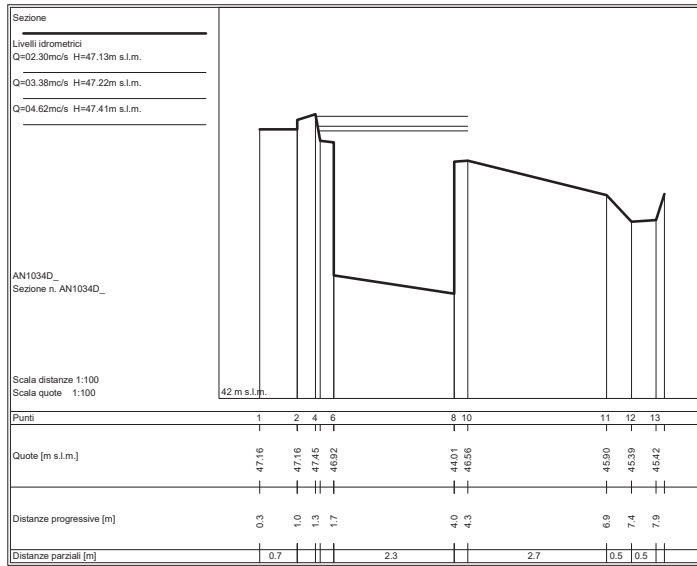

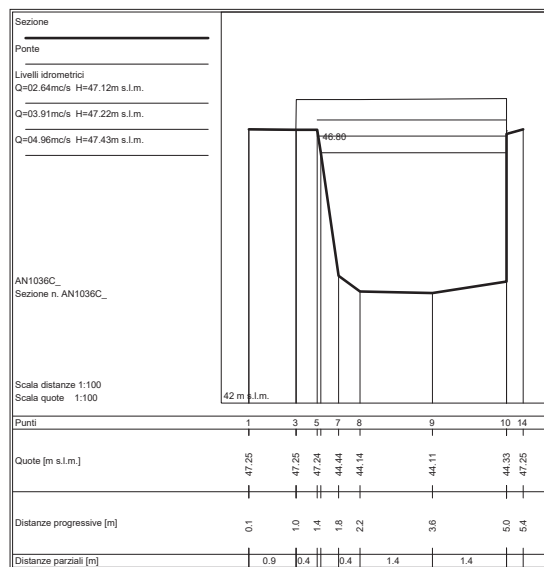
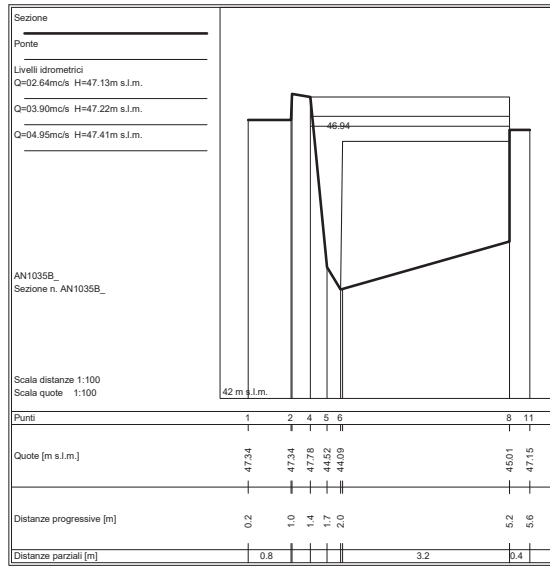

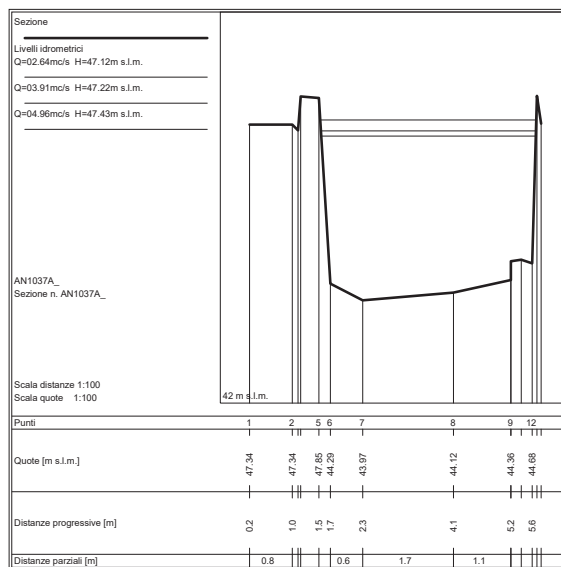
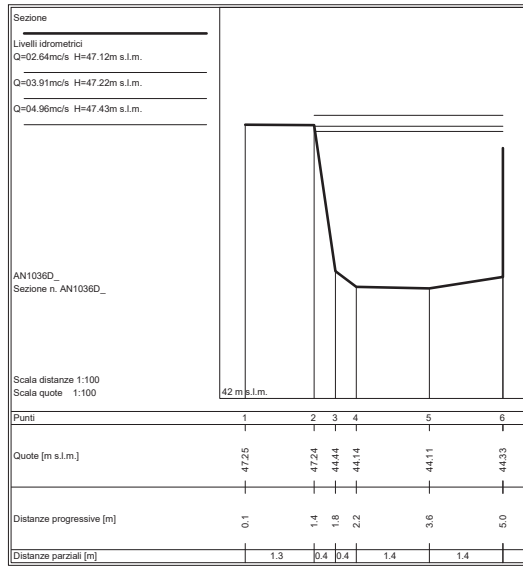

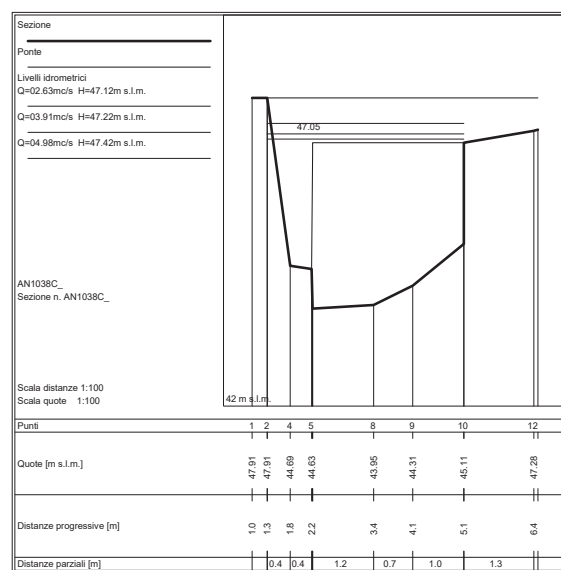
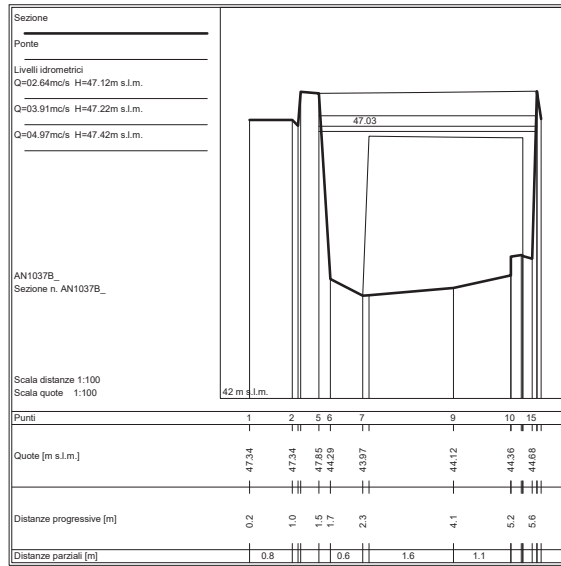

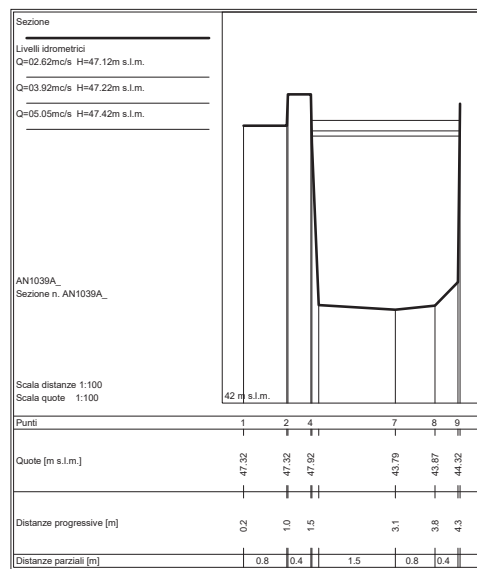
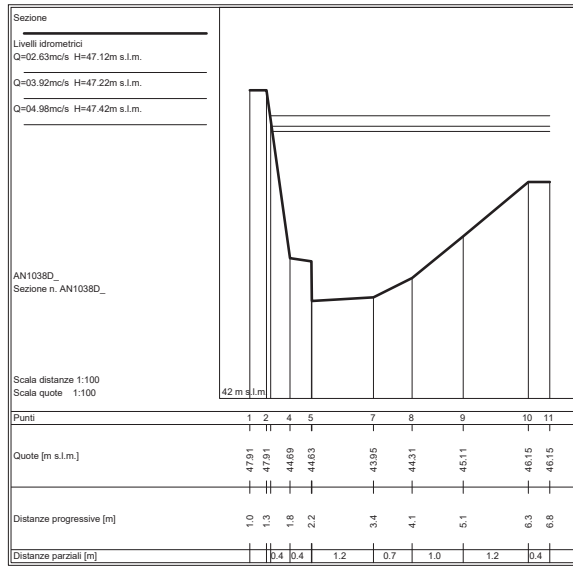

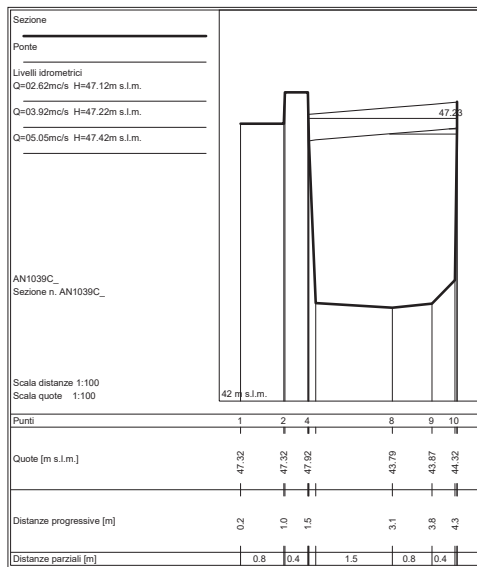
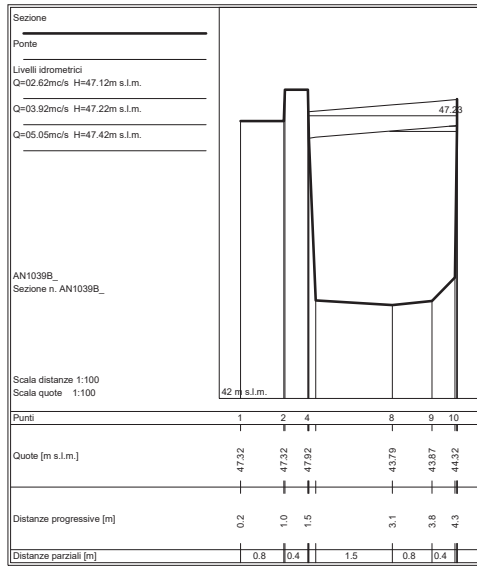



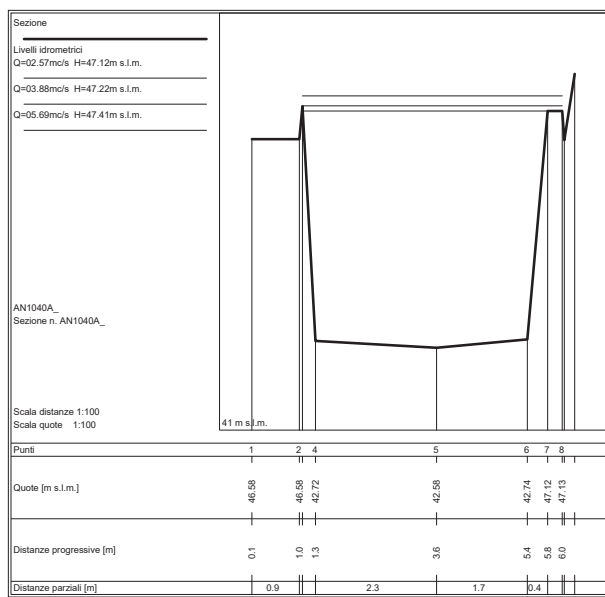
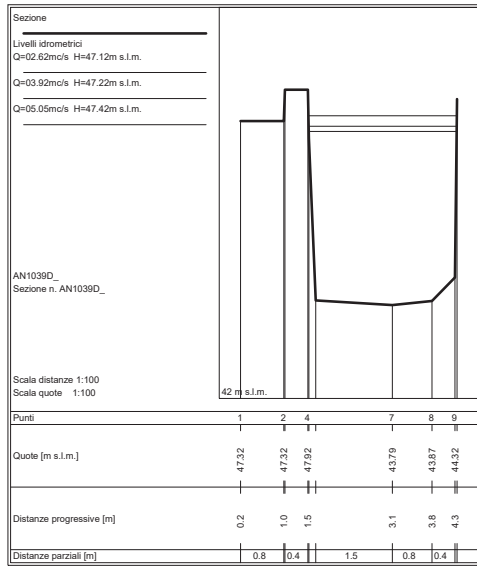

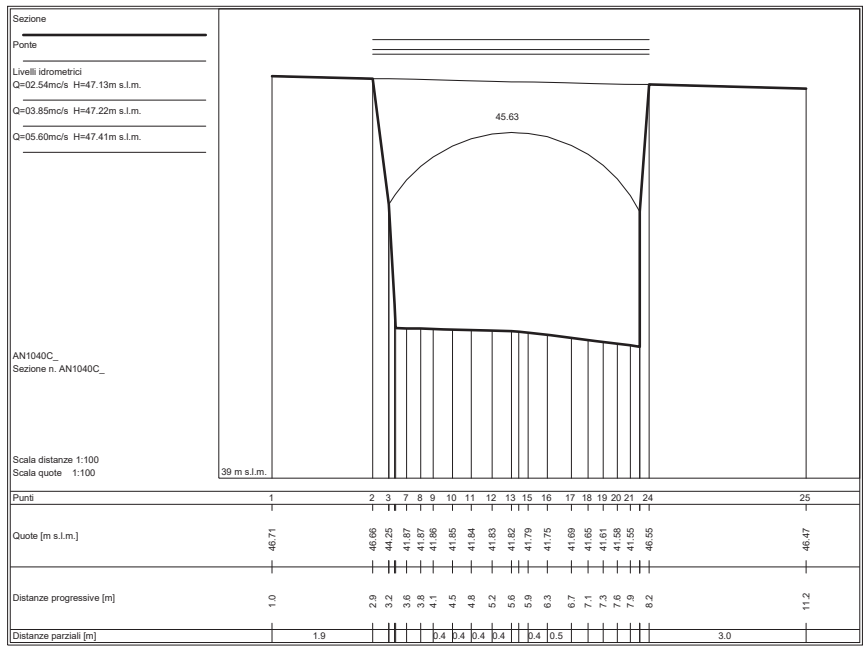
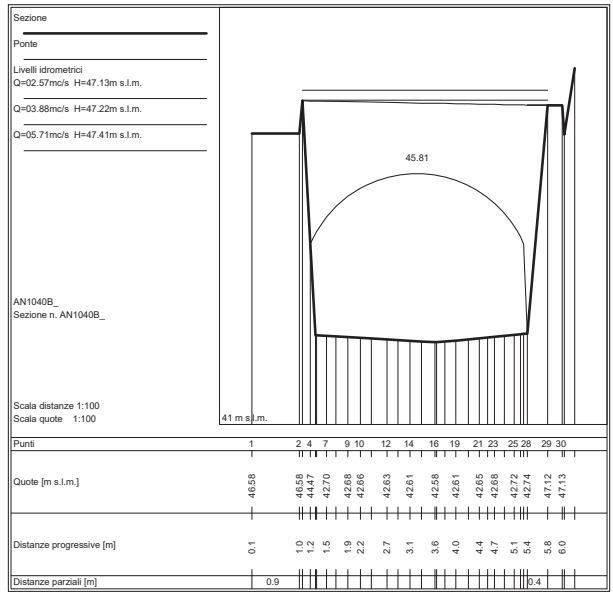

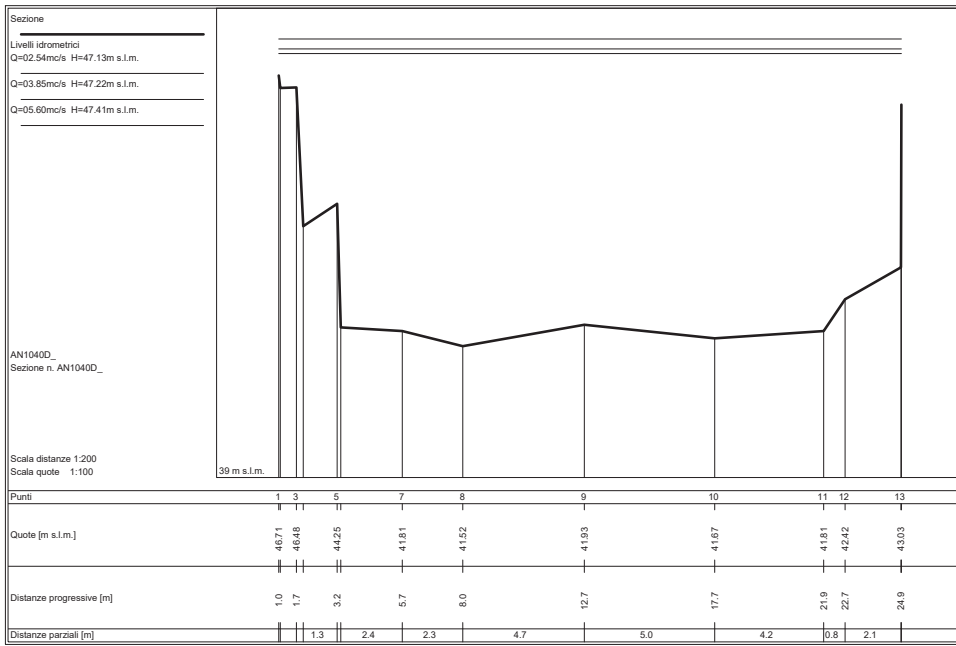

SEZIONI FLUVIALI  
TORRENTE BAGNOLO

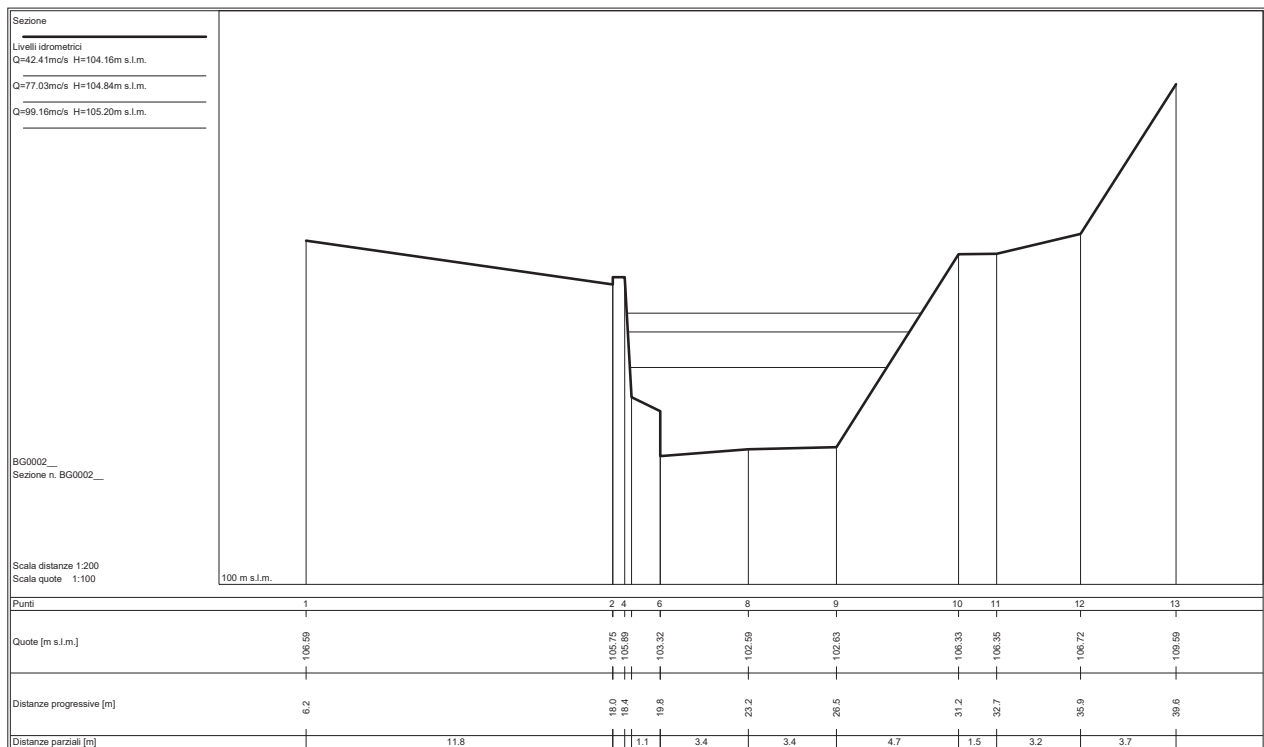
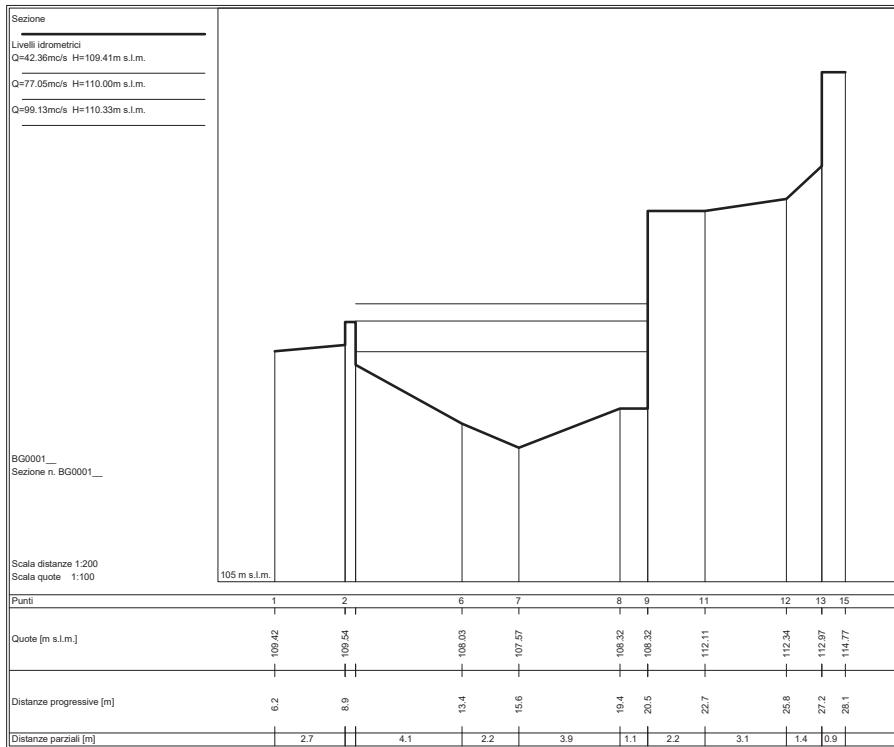

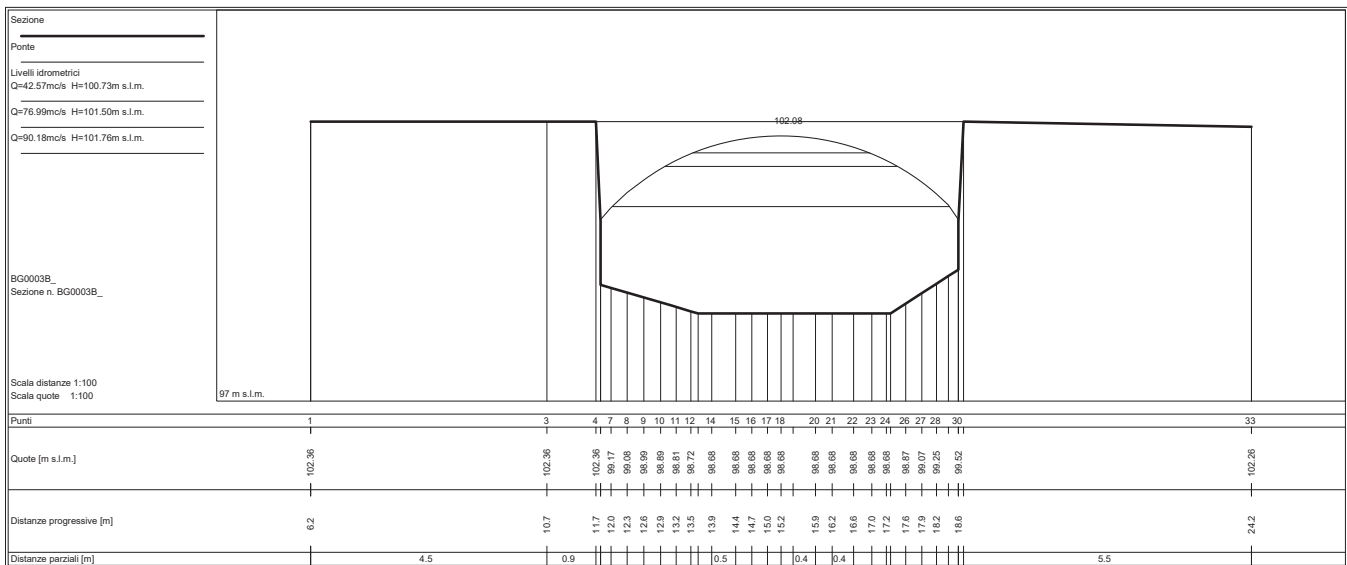
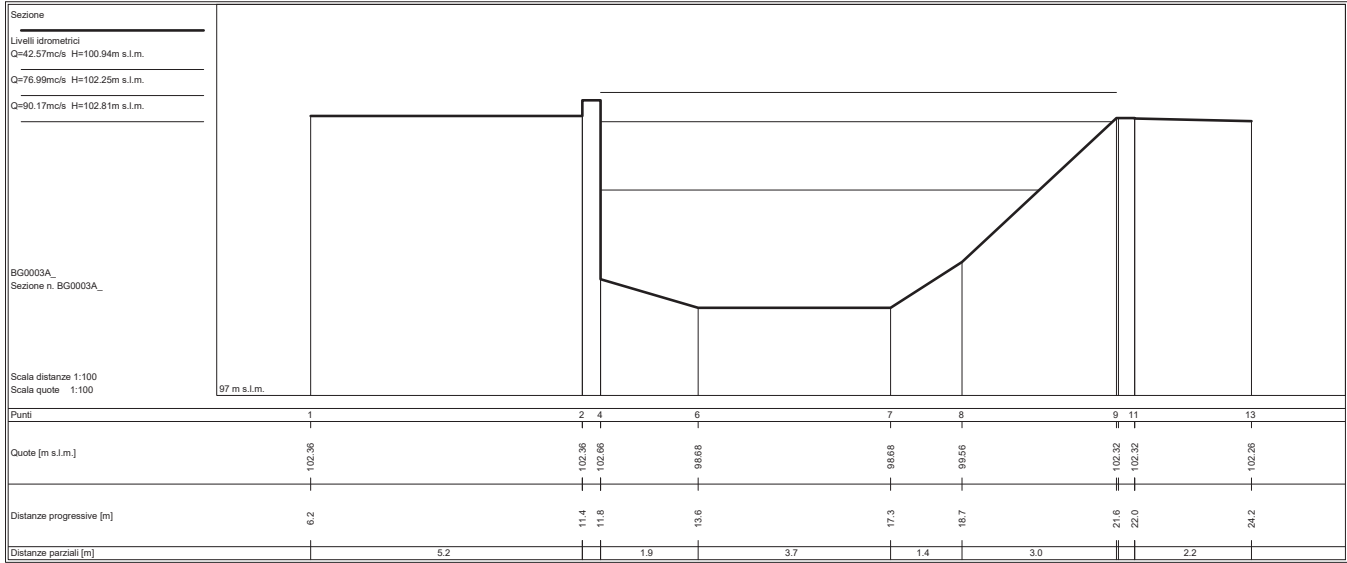

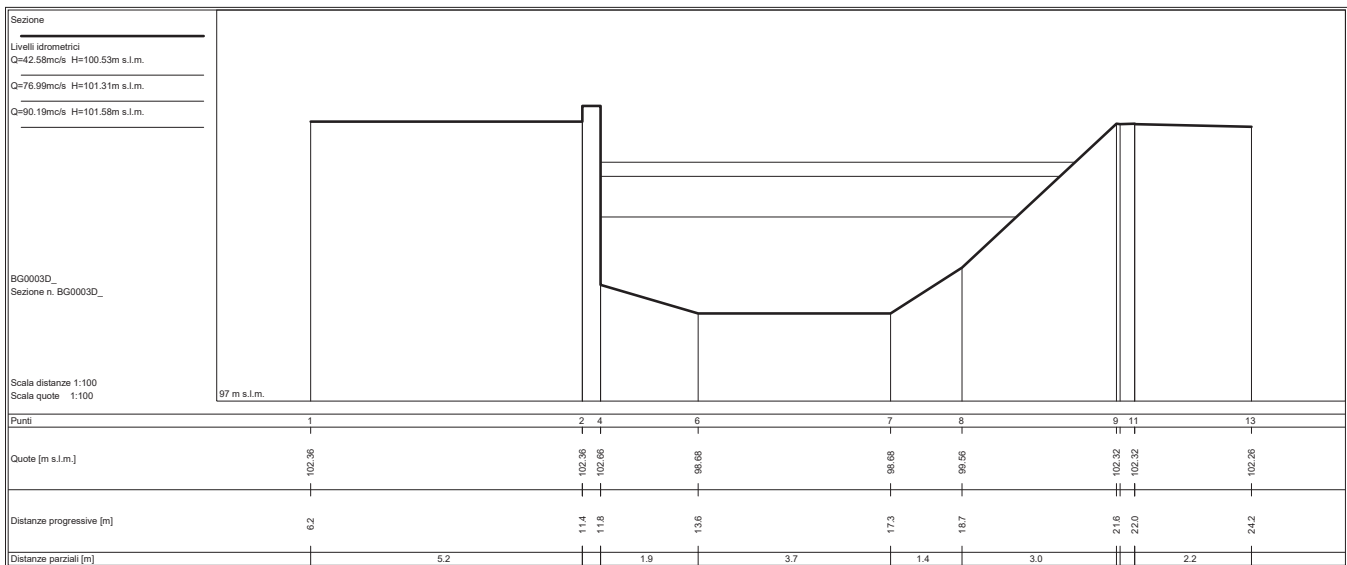
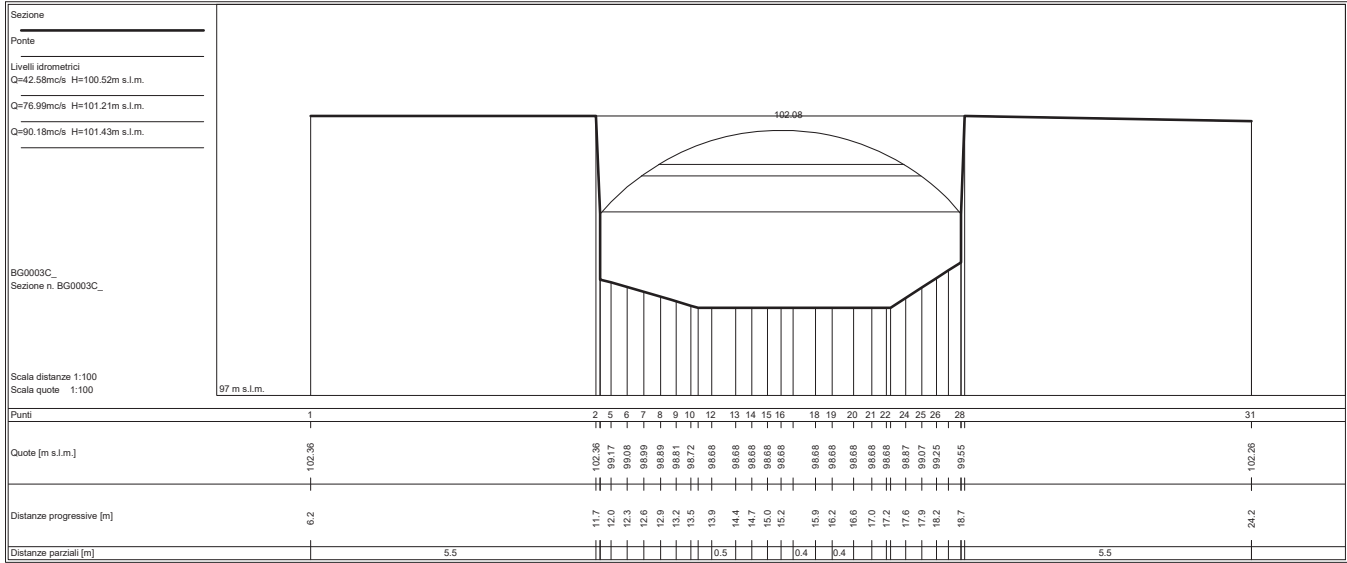

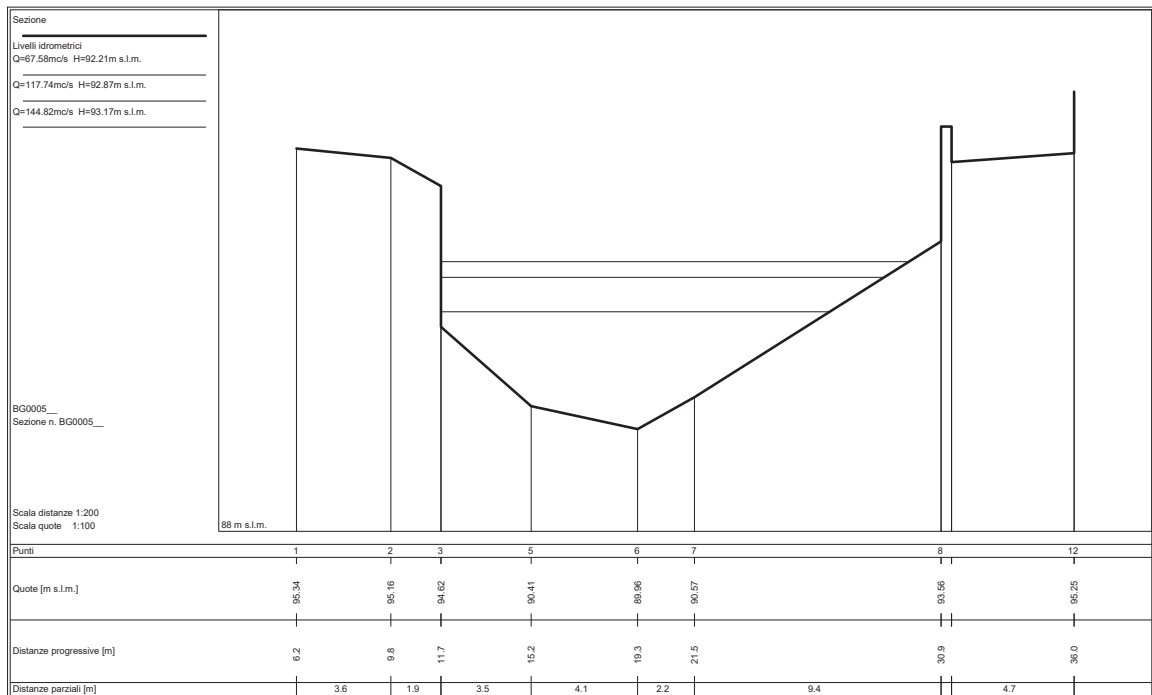
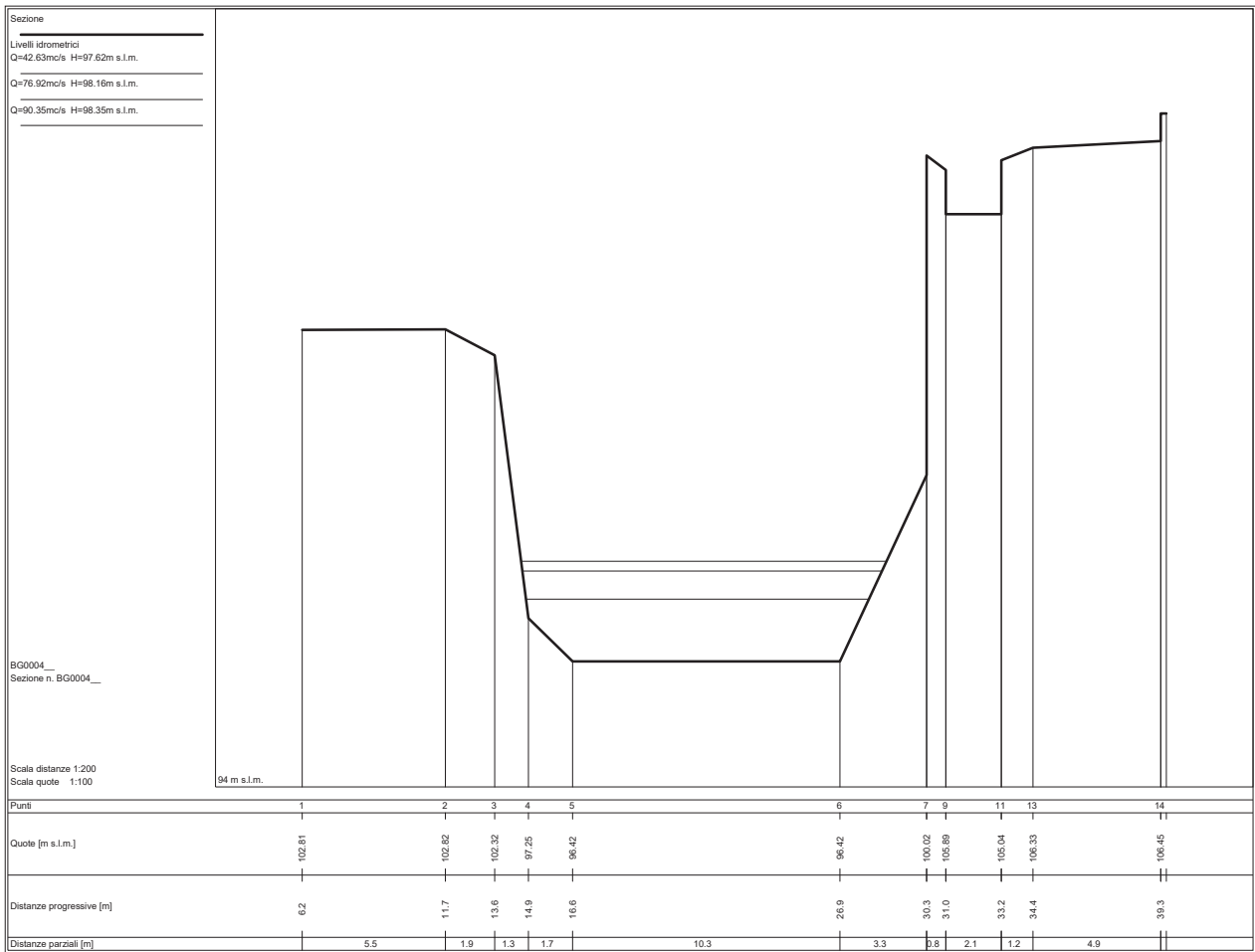



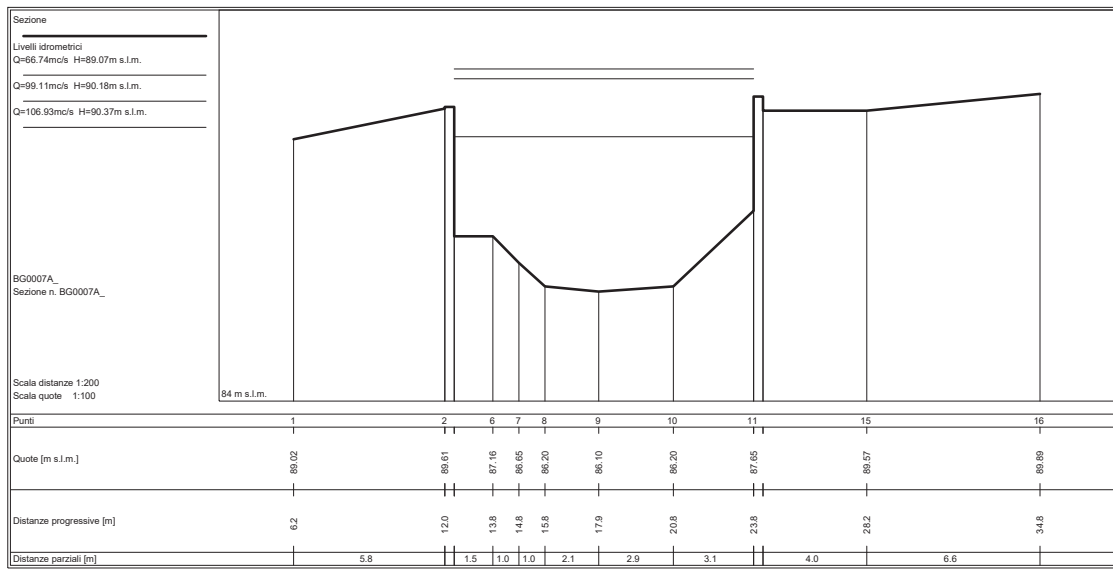
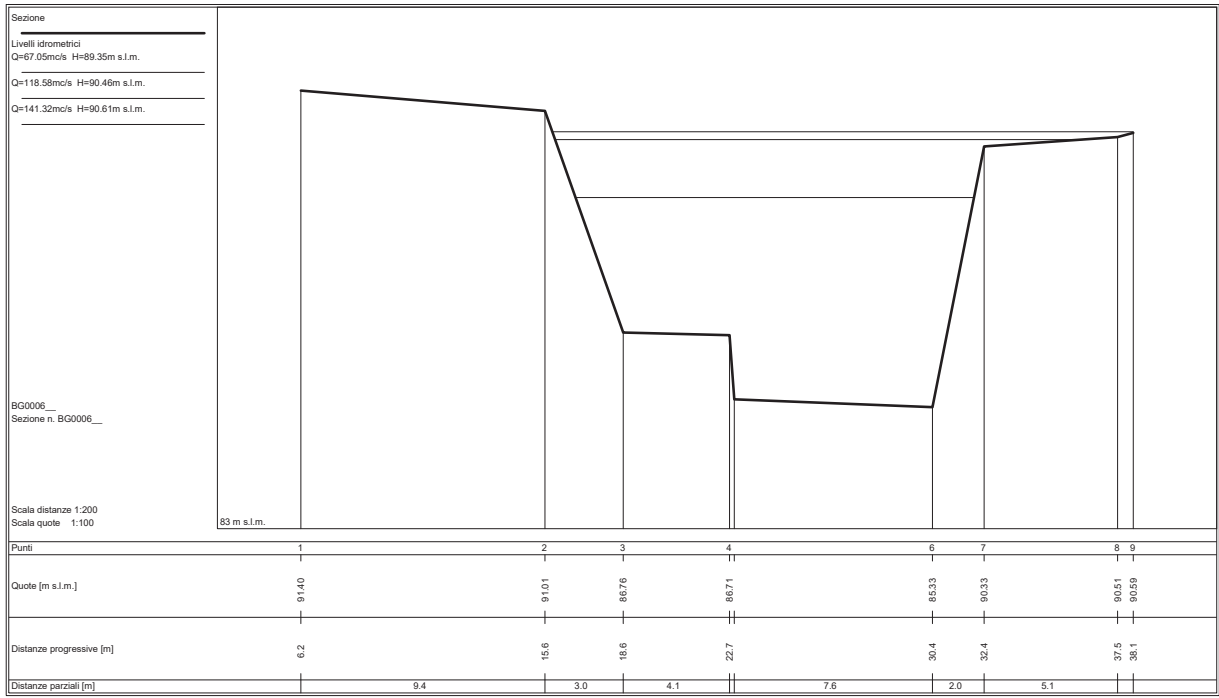

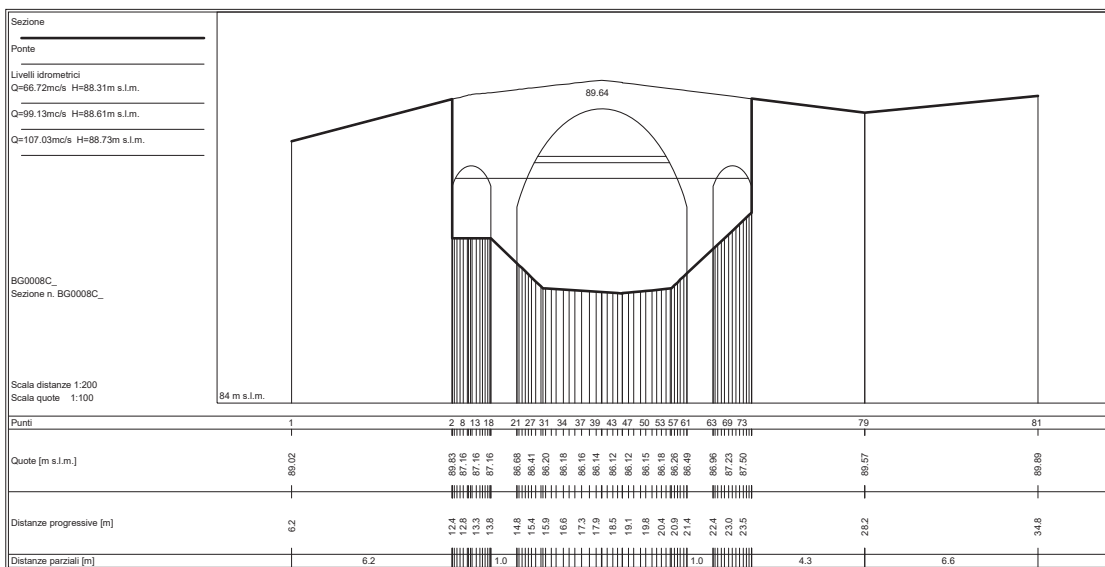
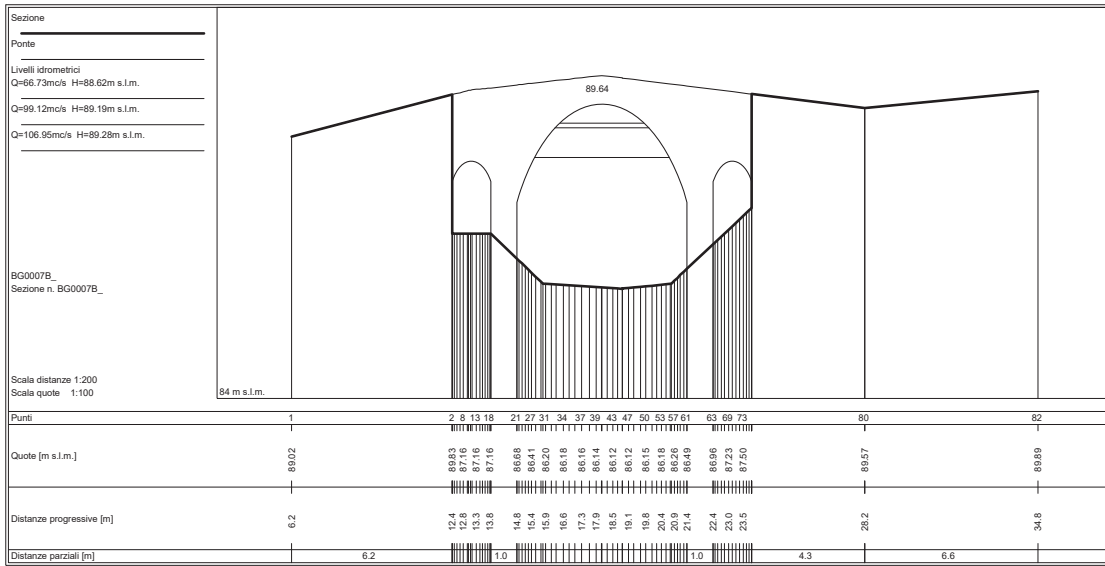

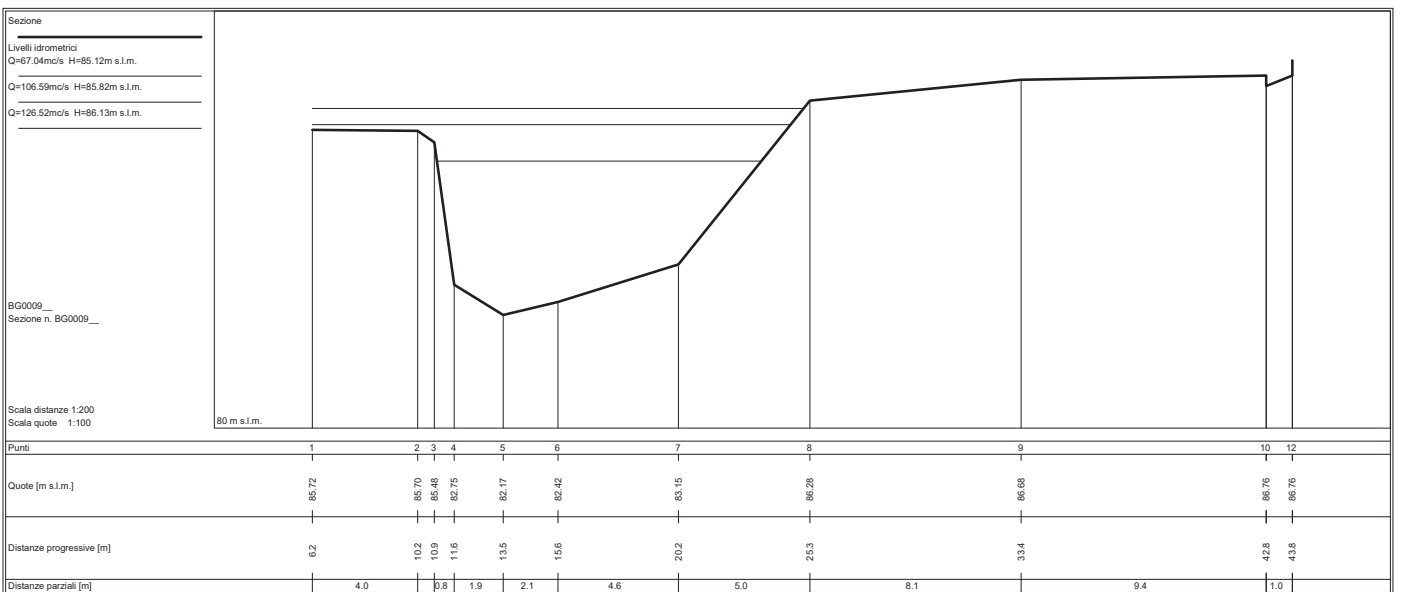
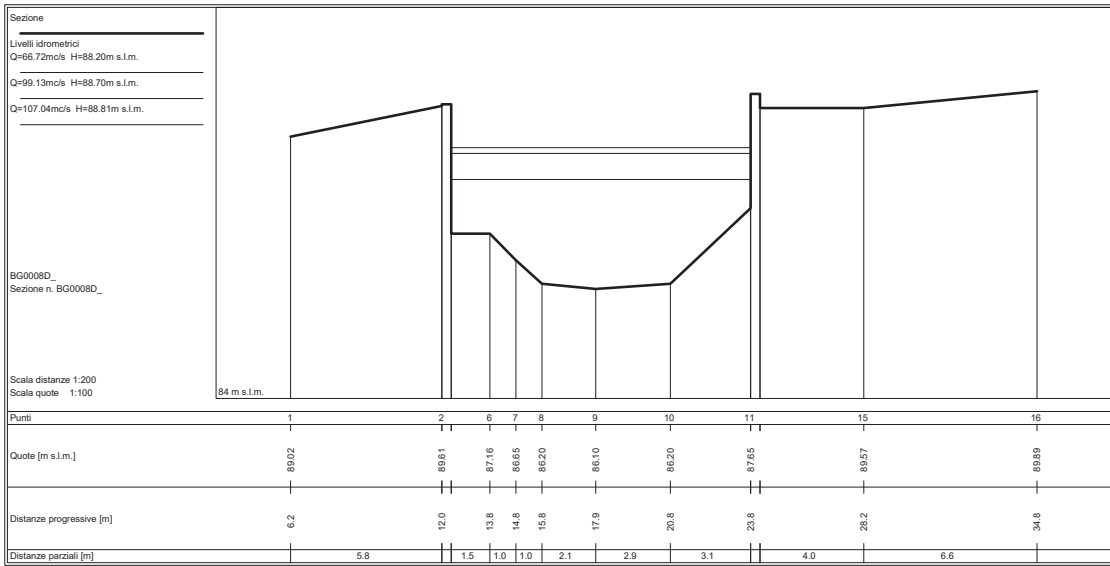

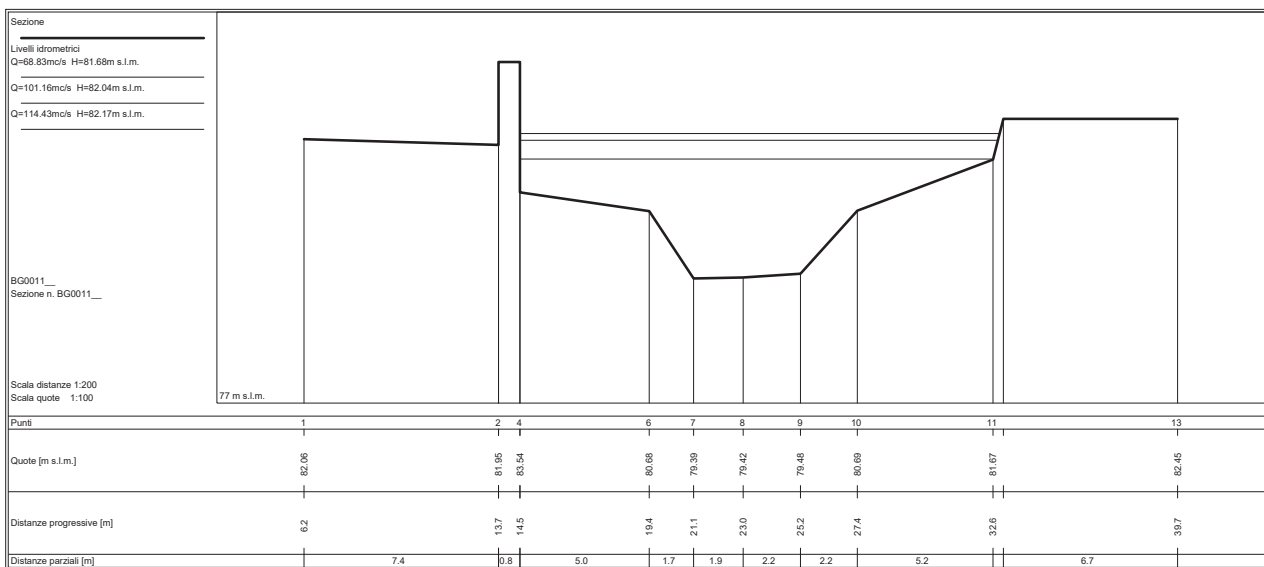
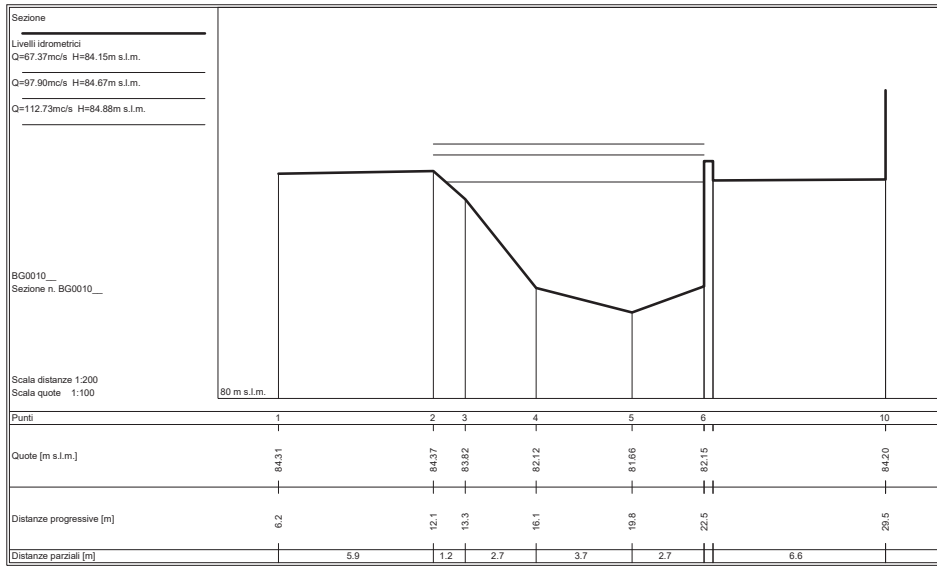

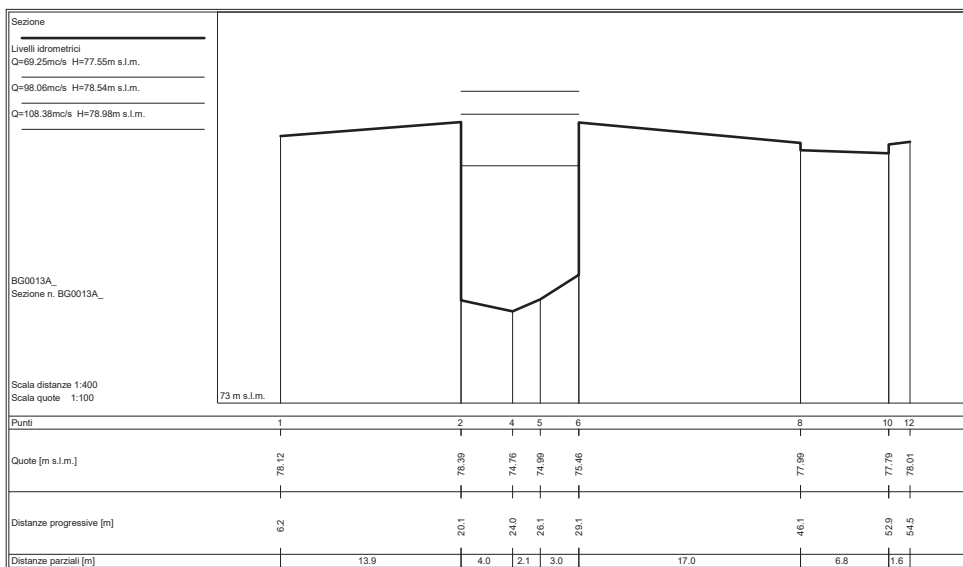
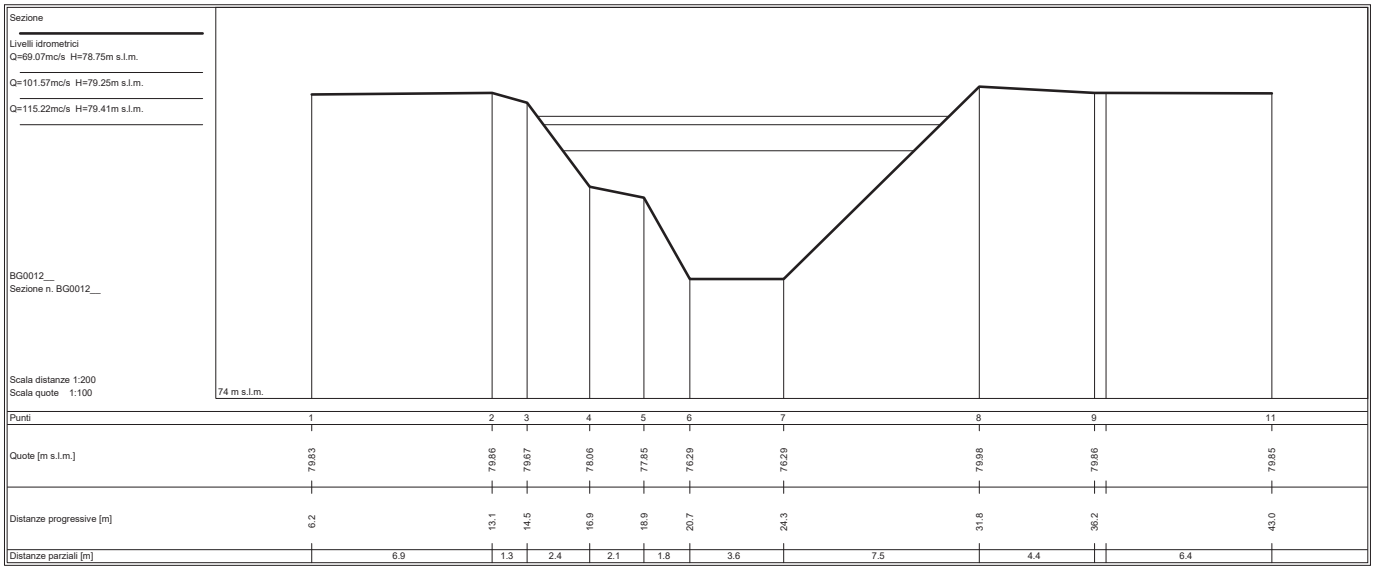

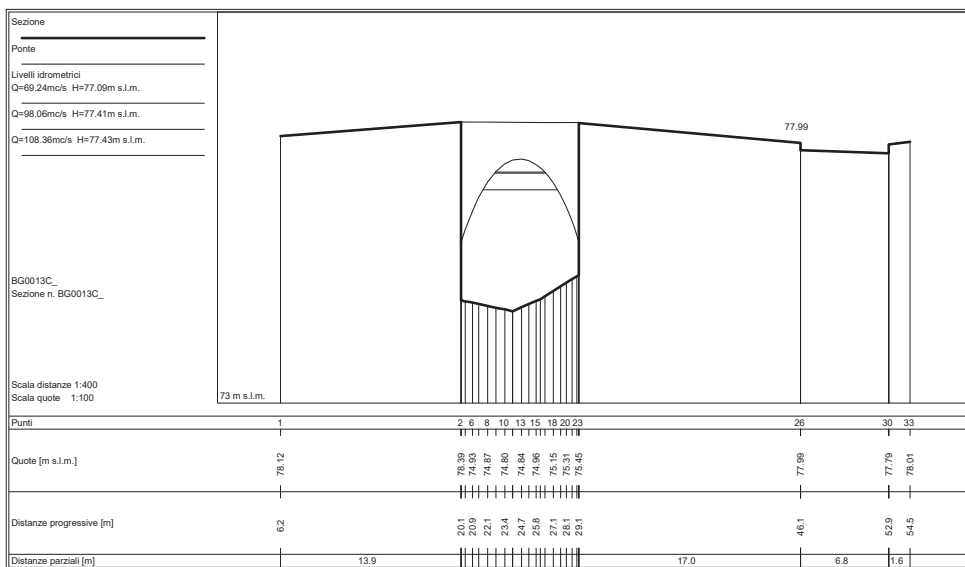
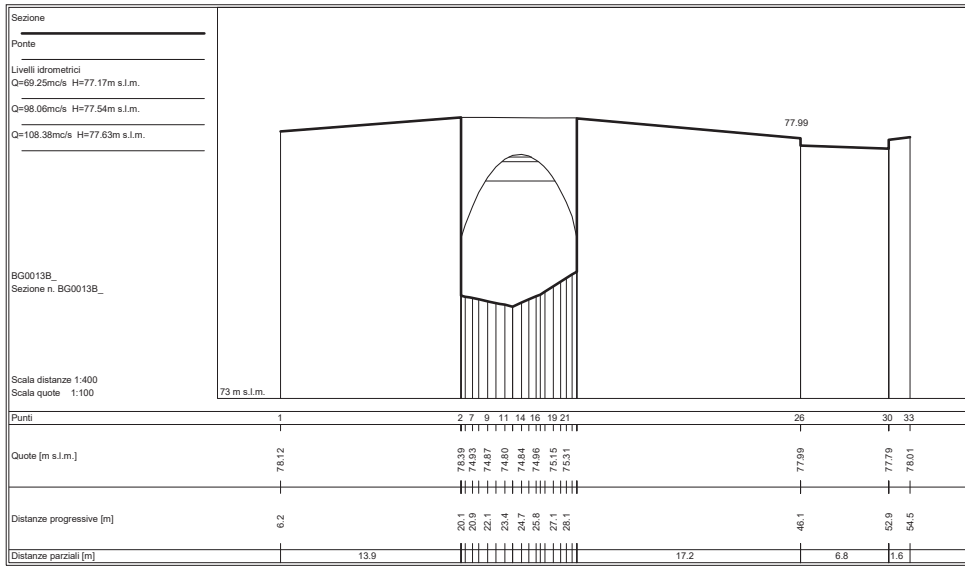

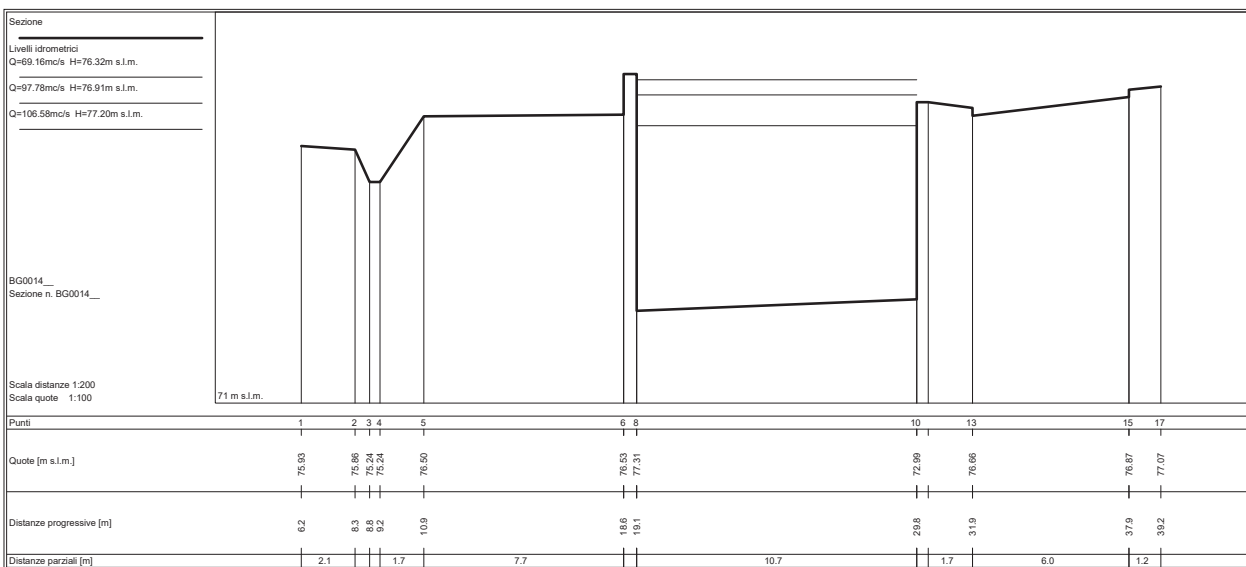
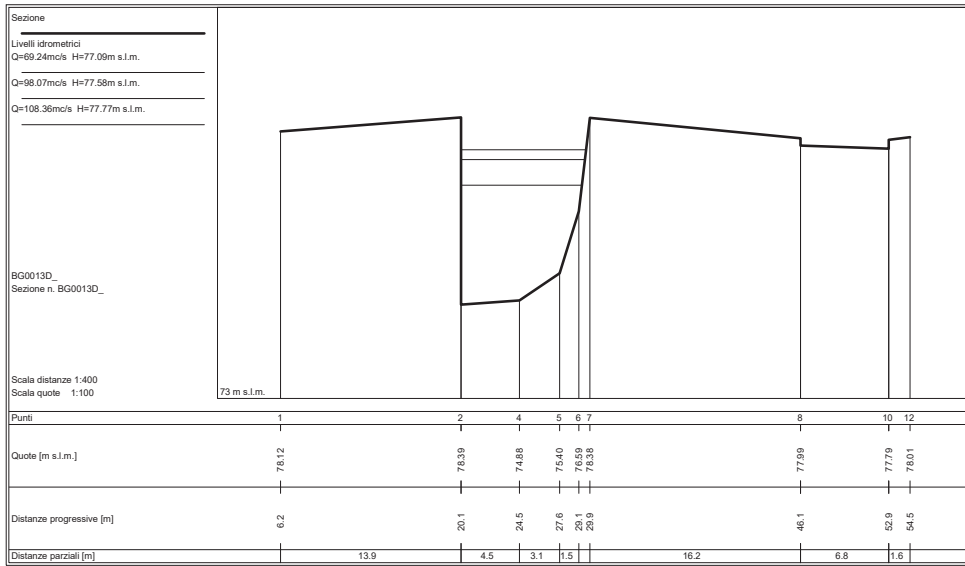

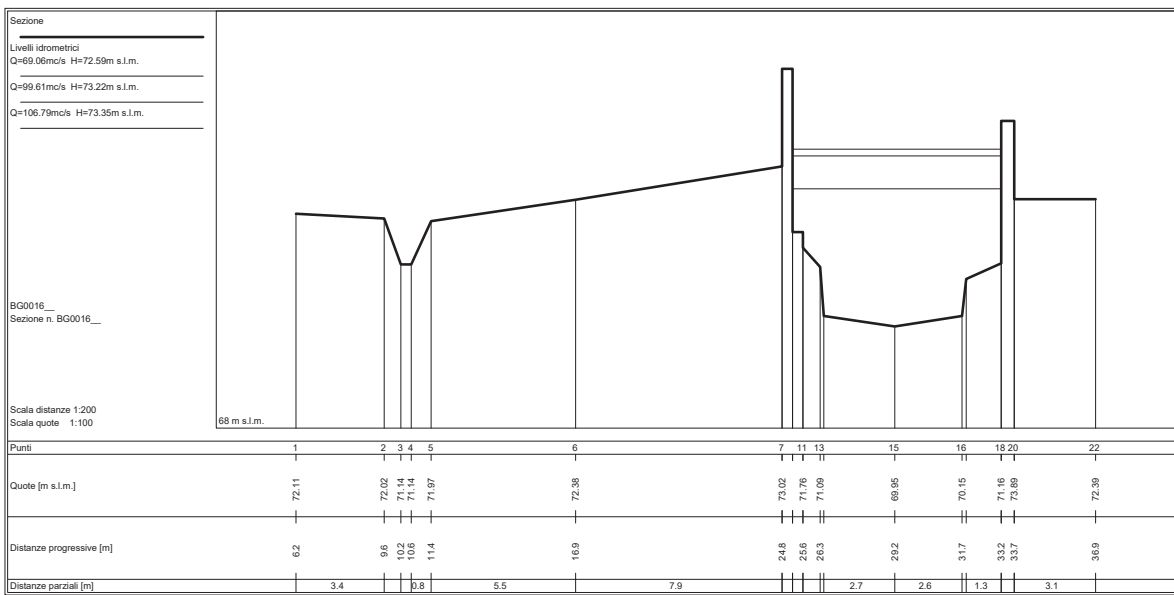
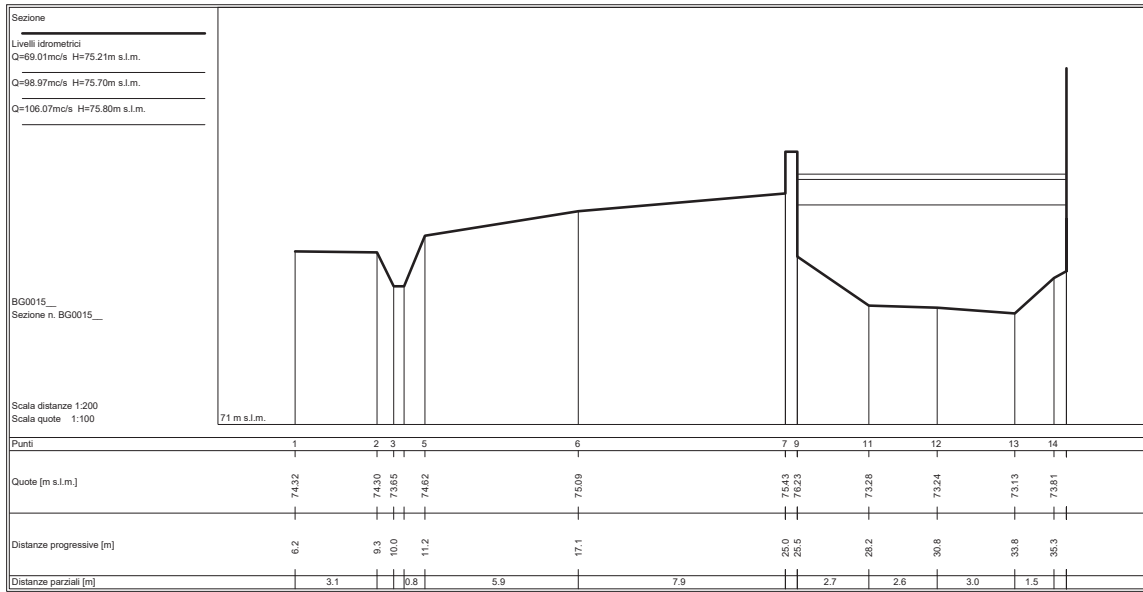



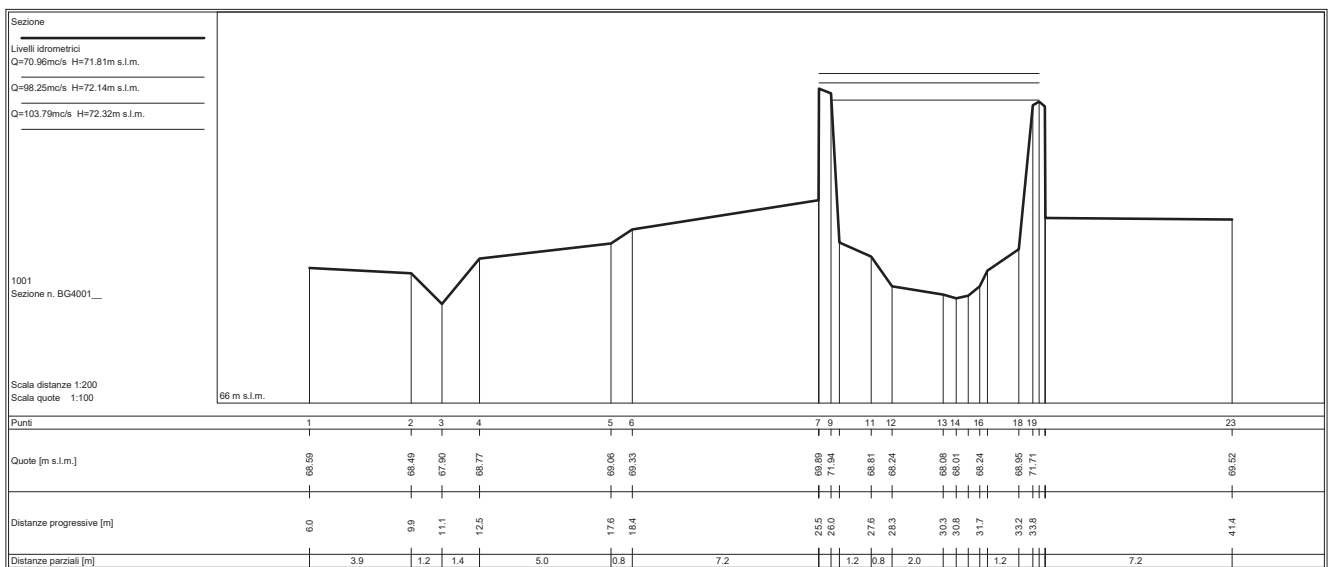
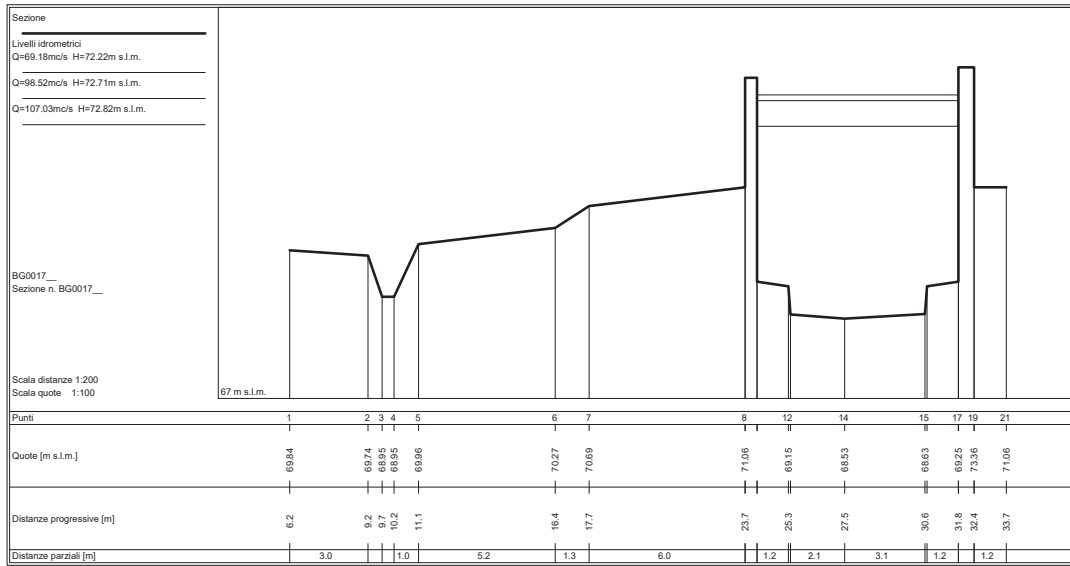

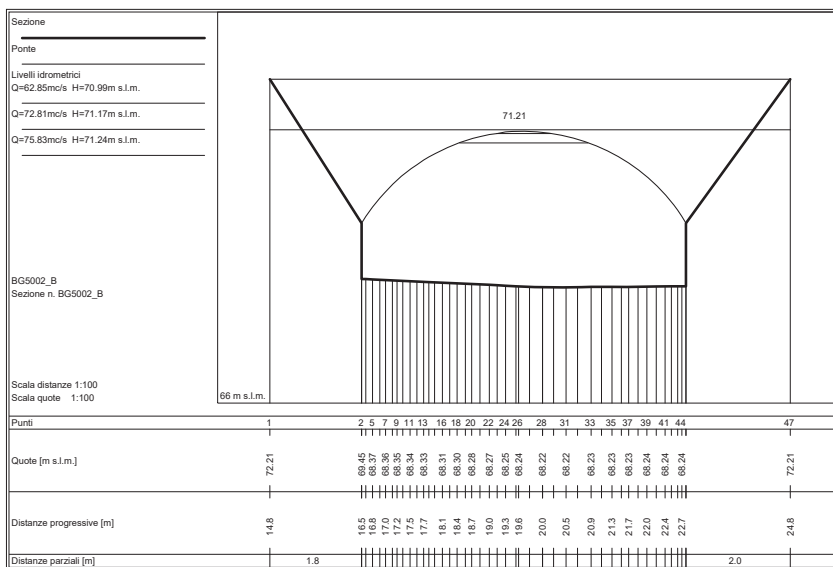
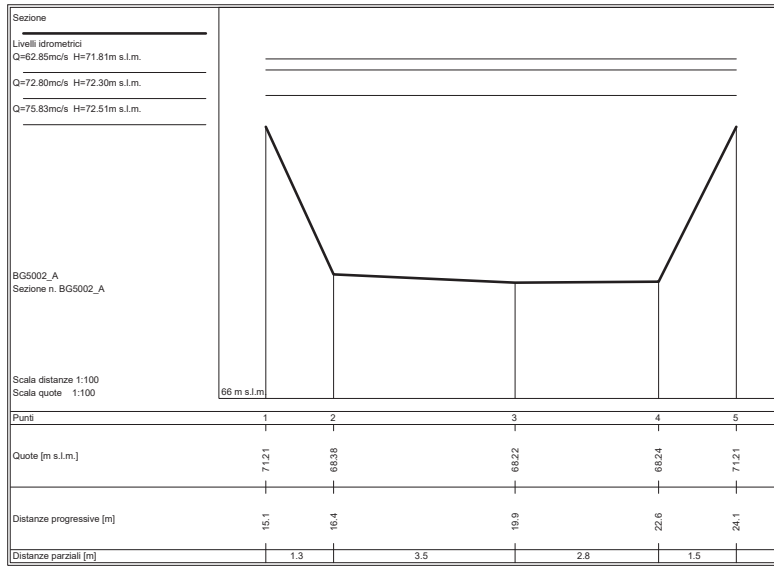

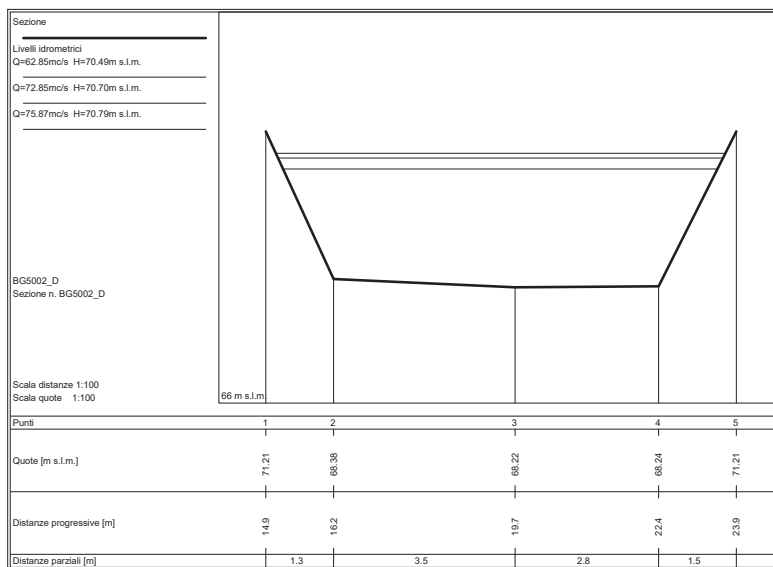
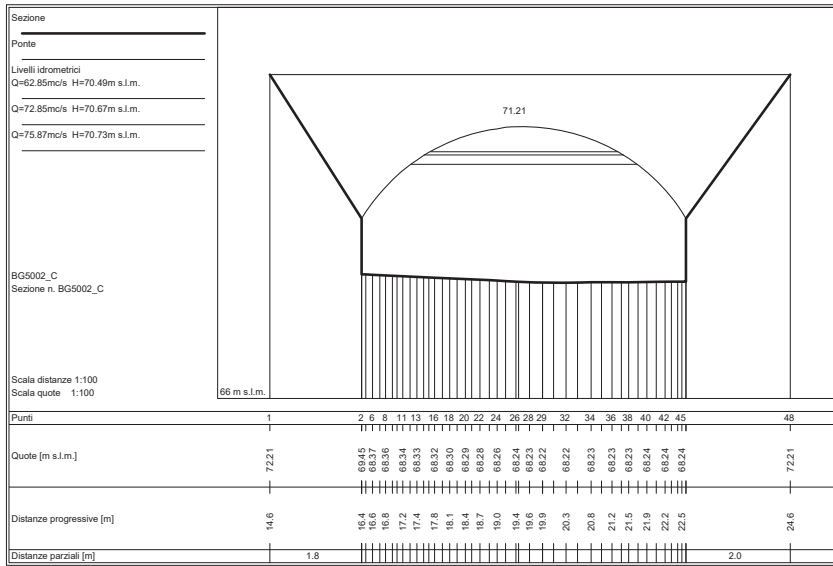

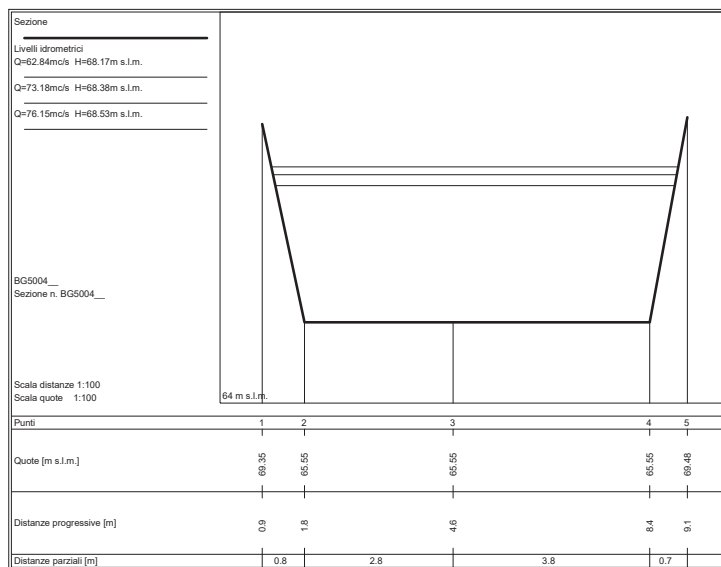
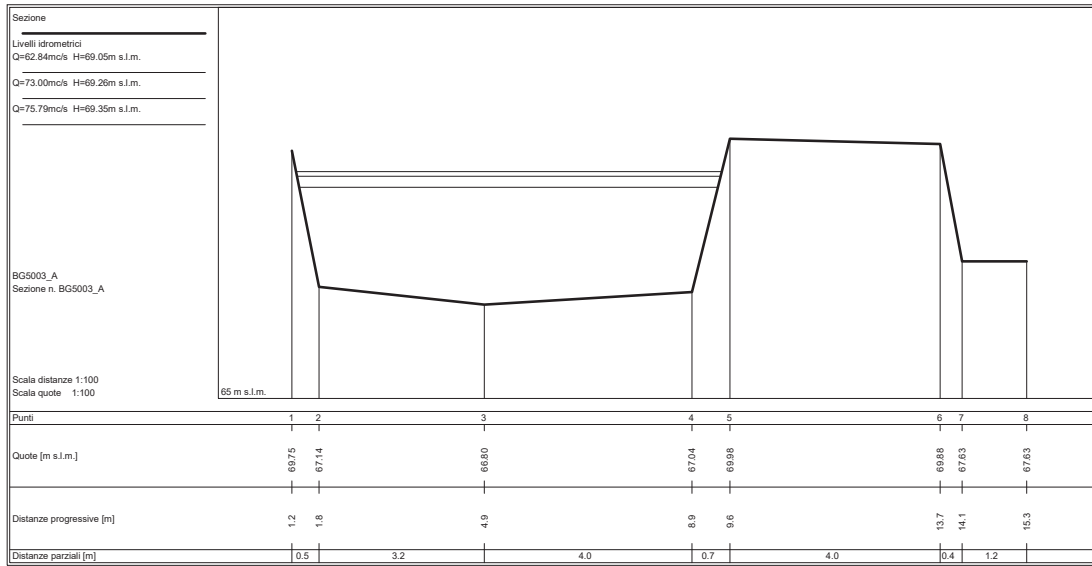

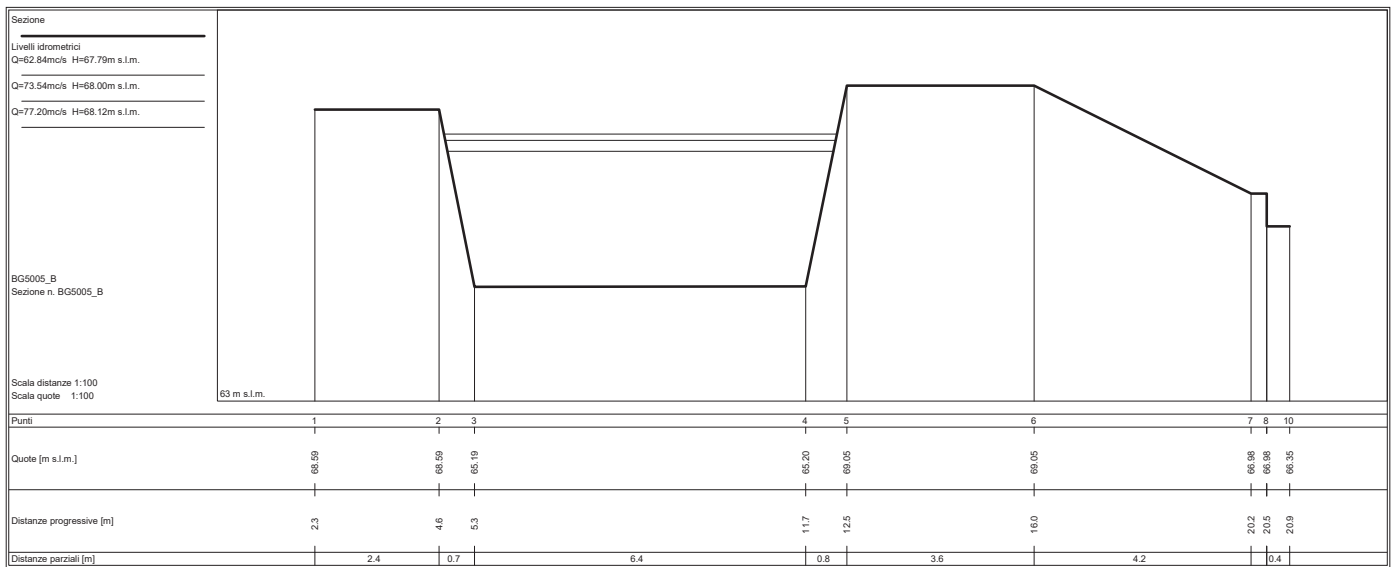
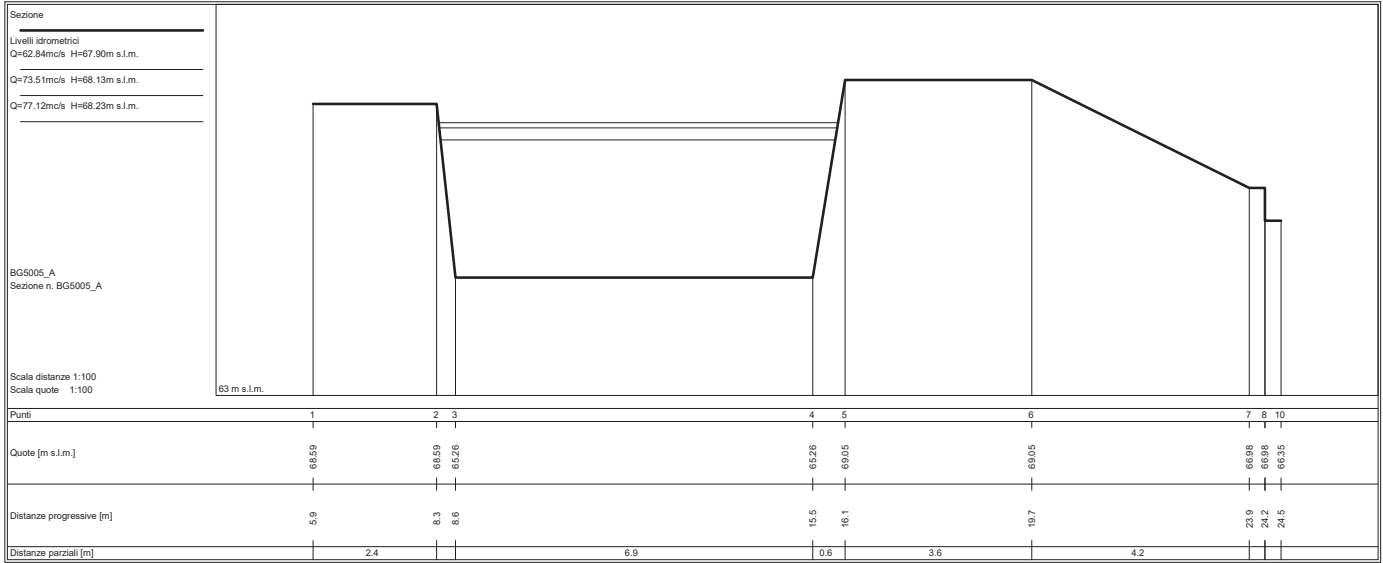

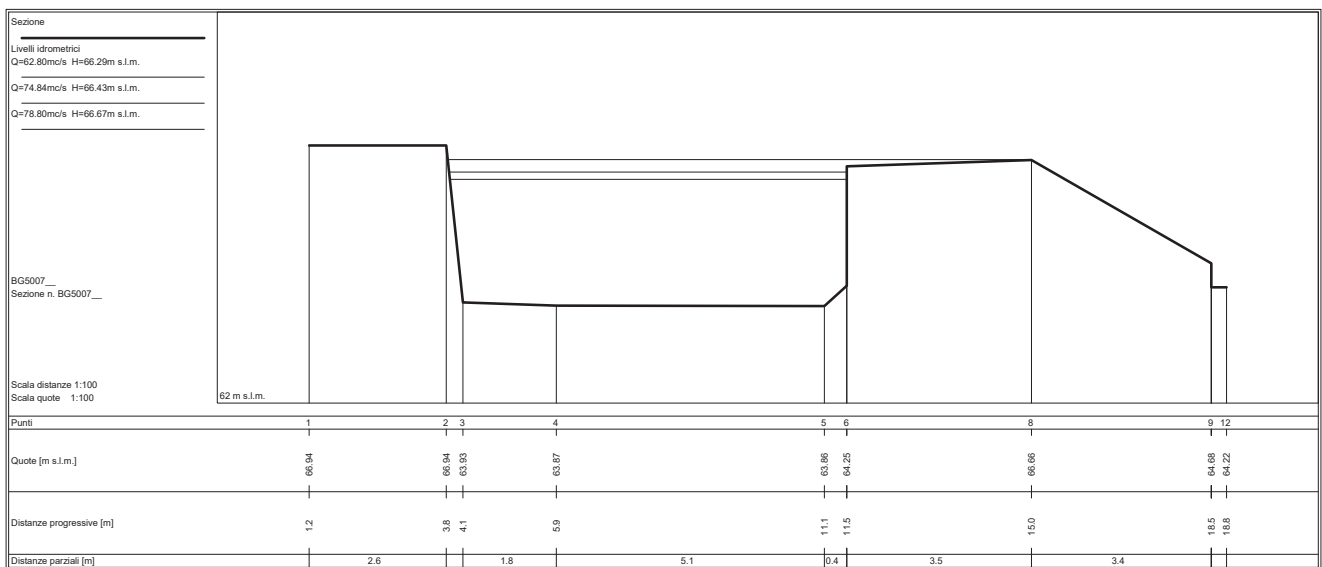
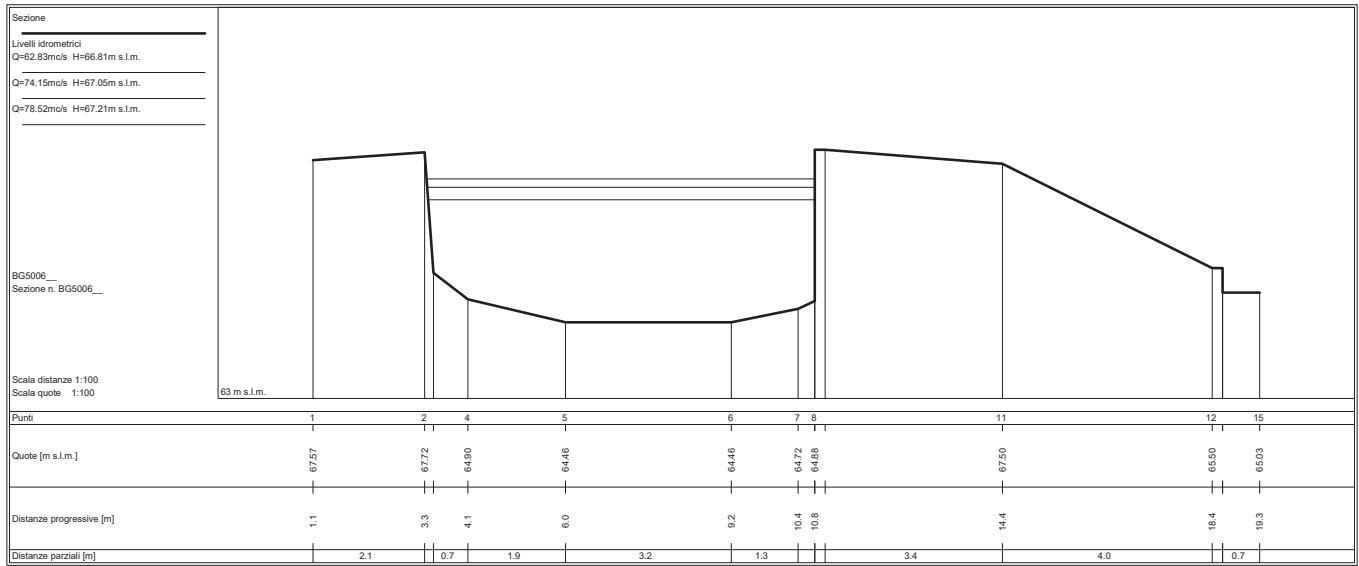

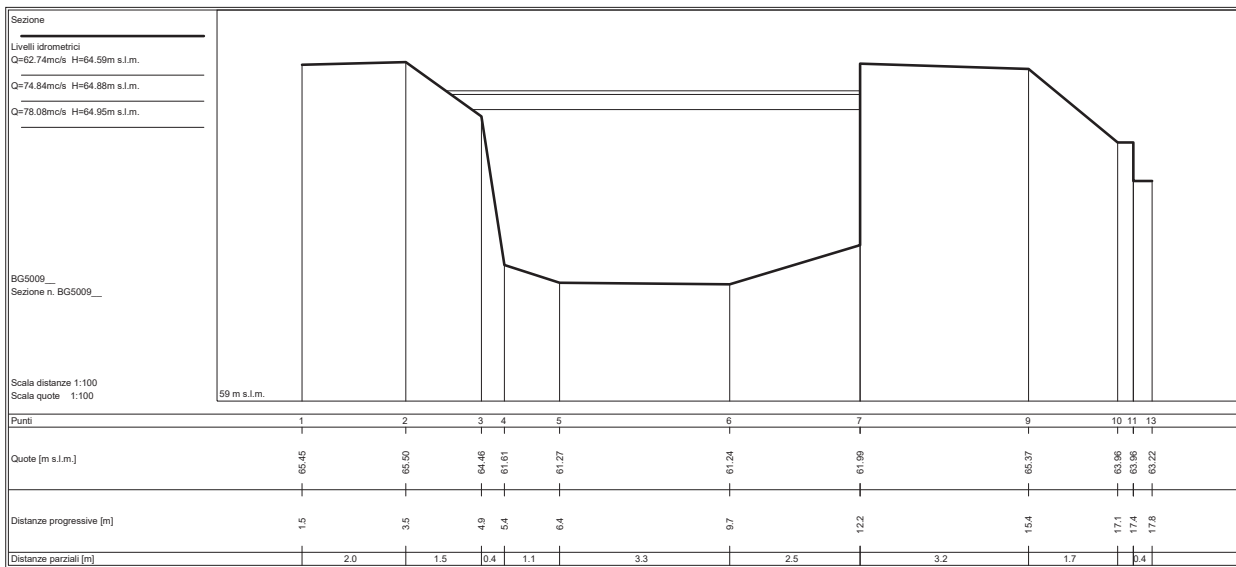
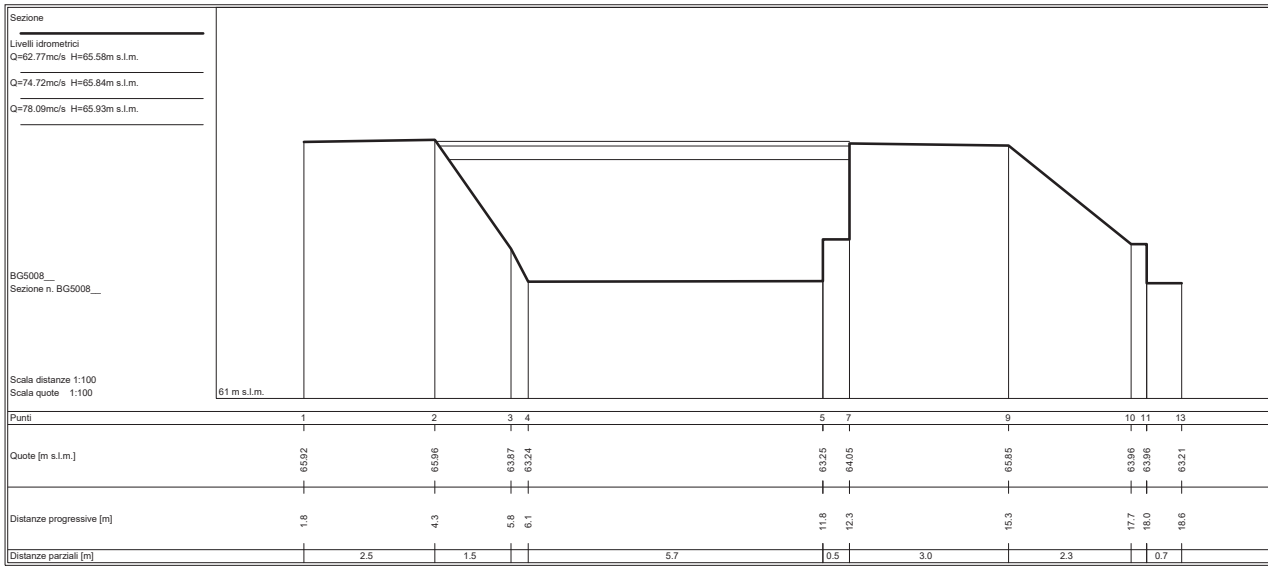

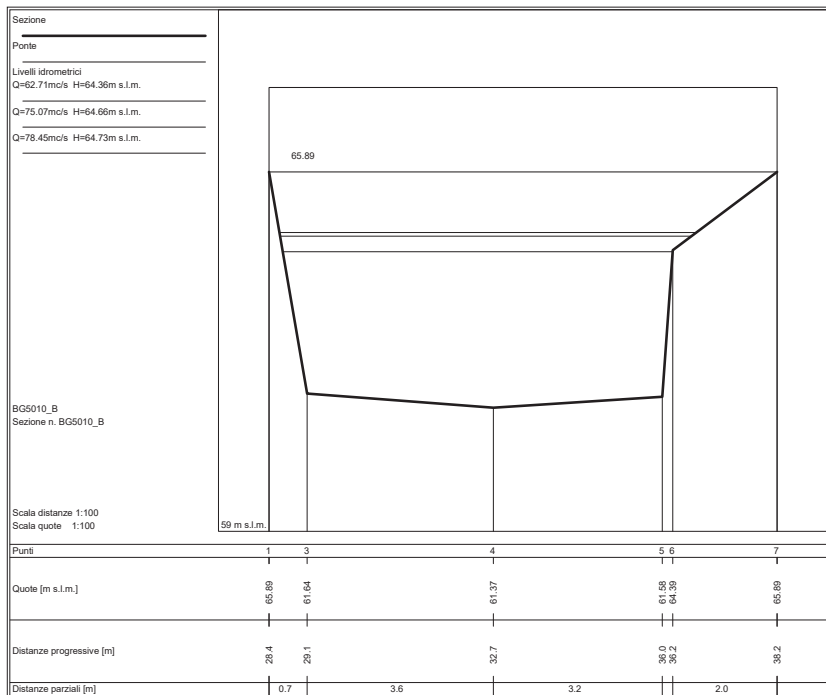
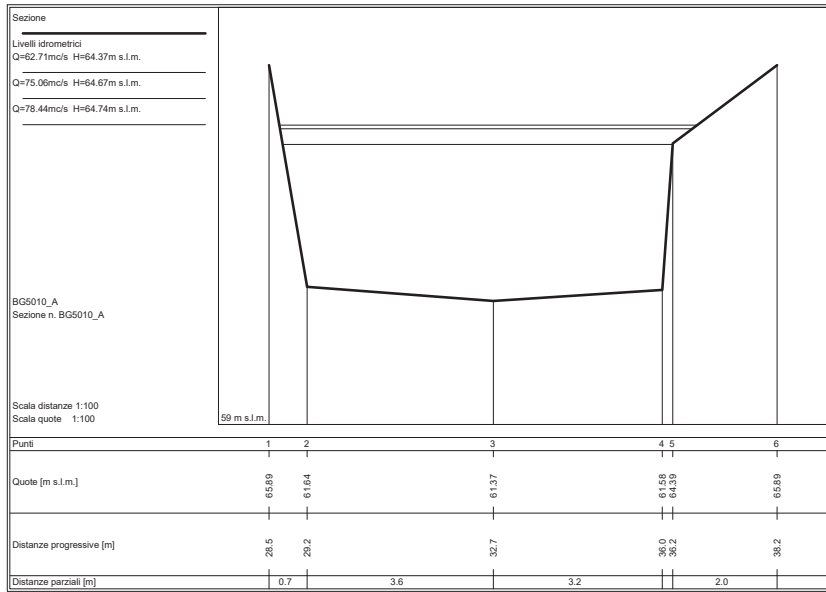



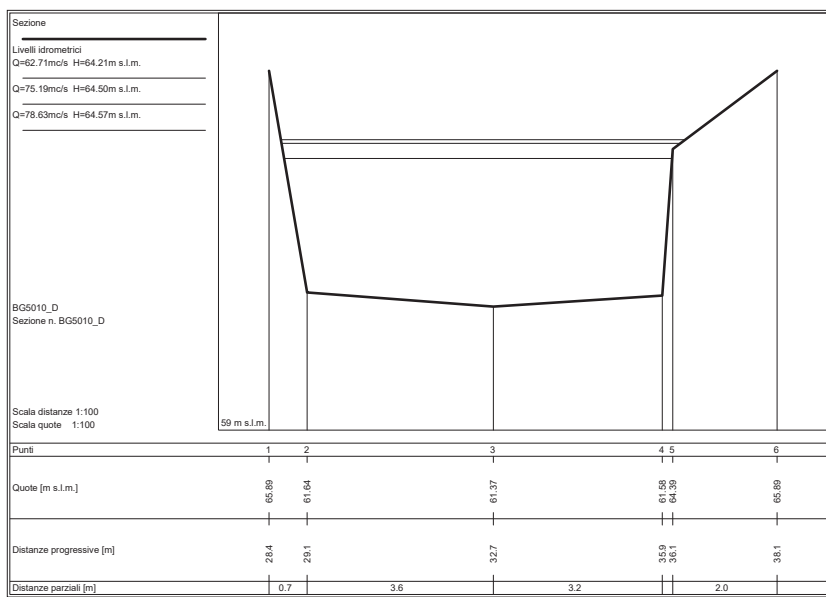
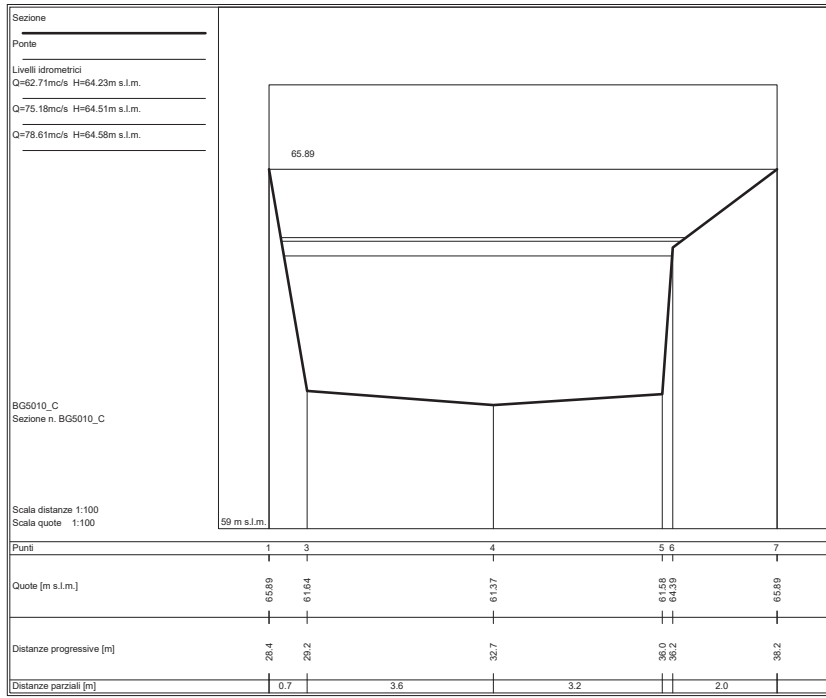

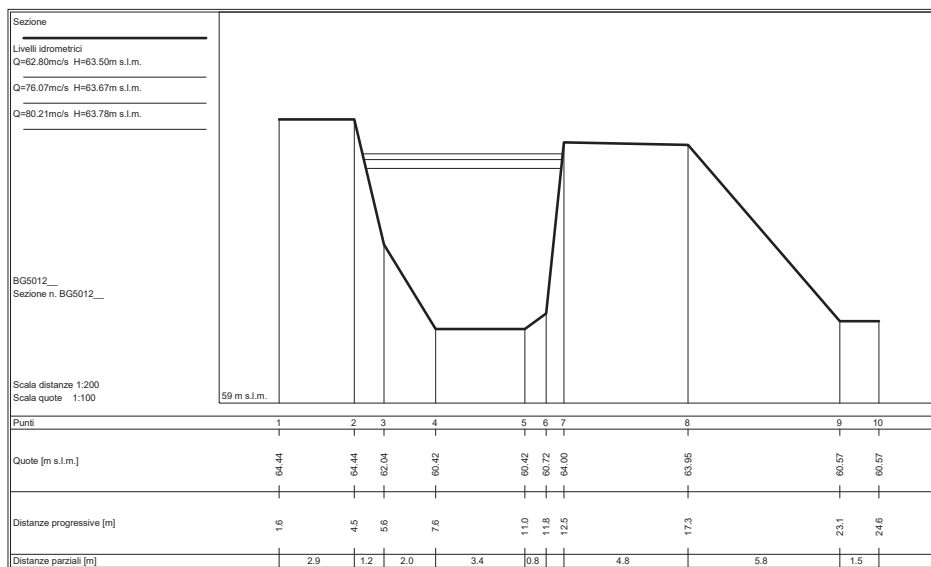
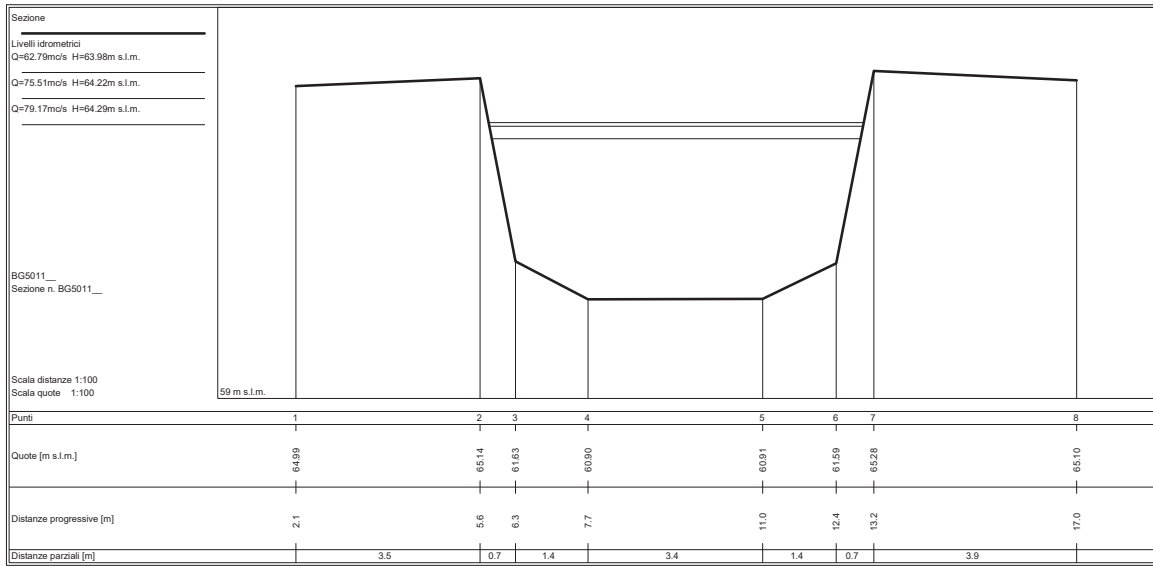

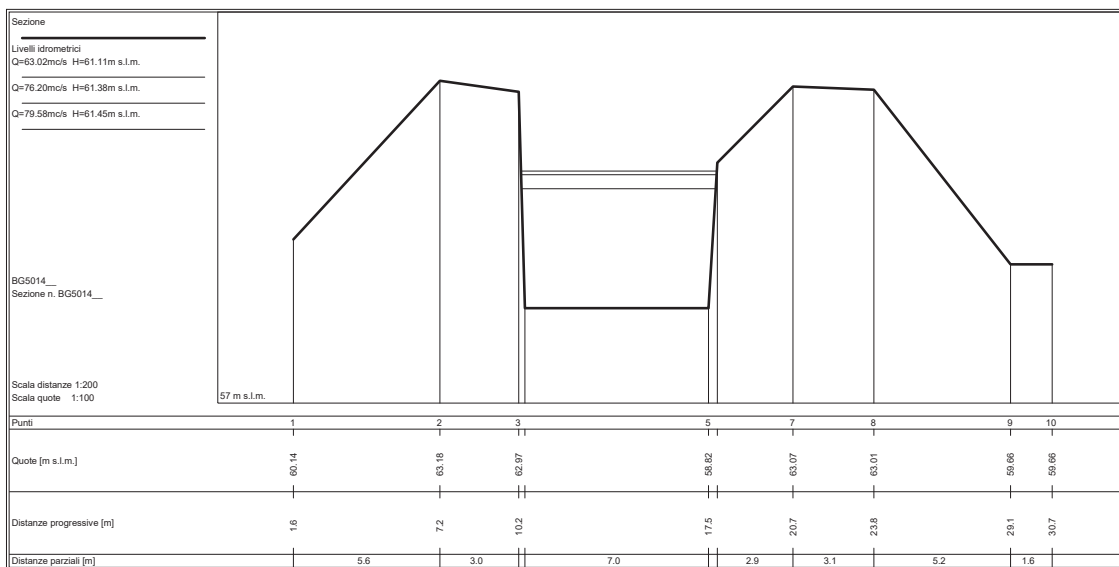
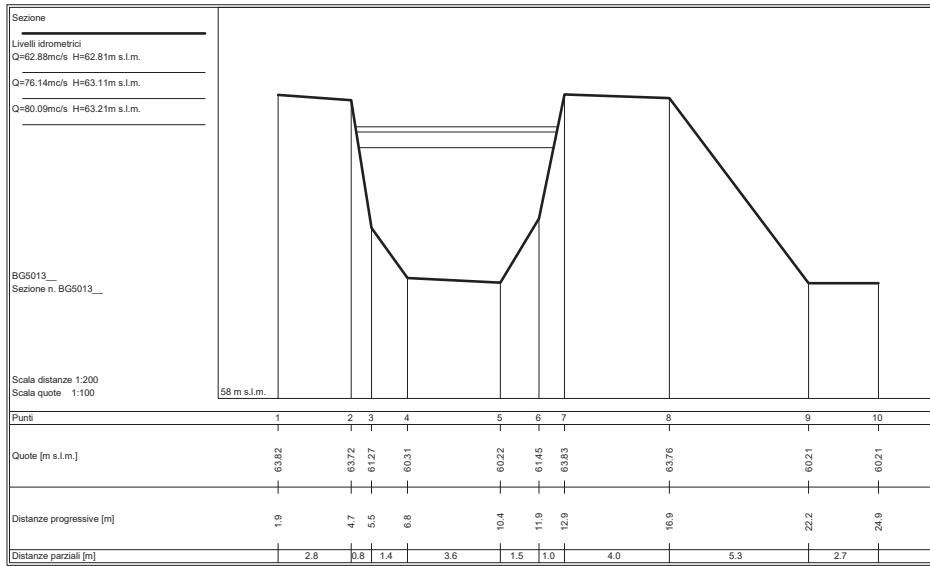

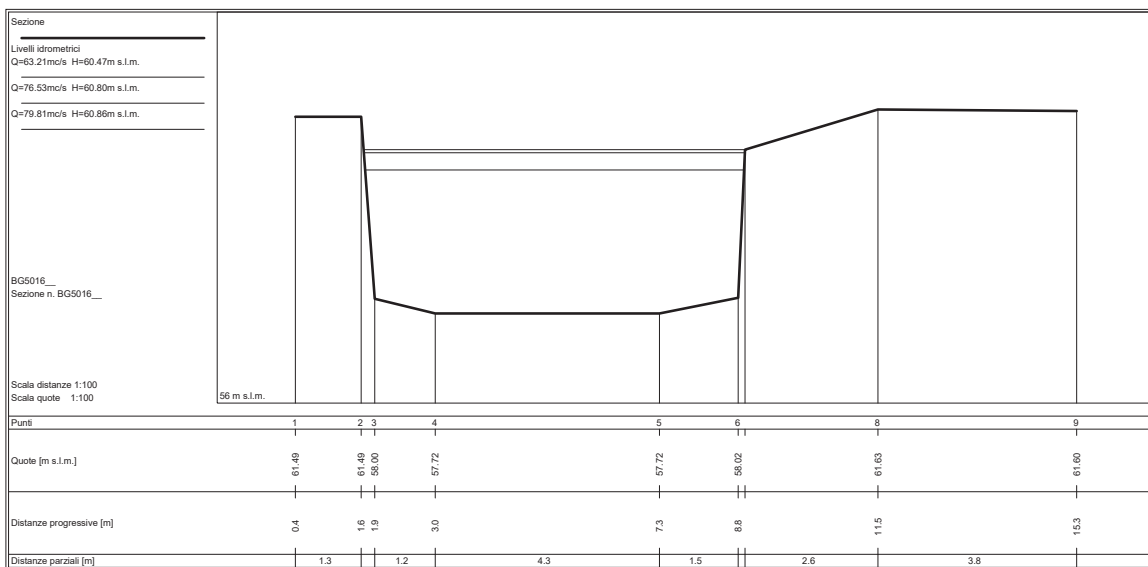
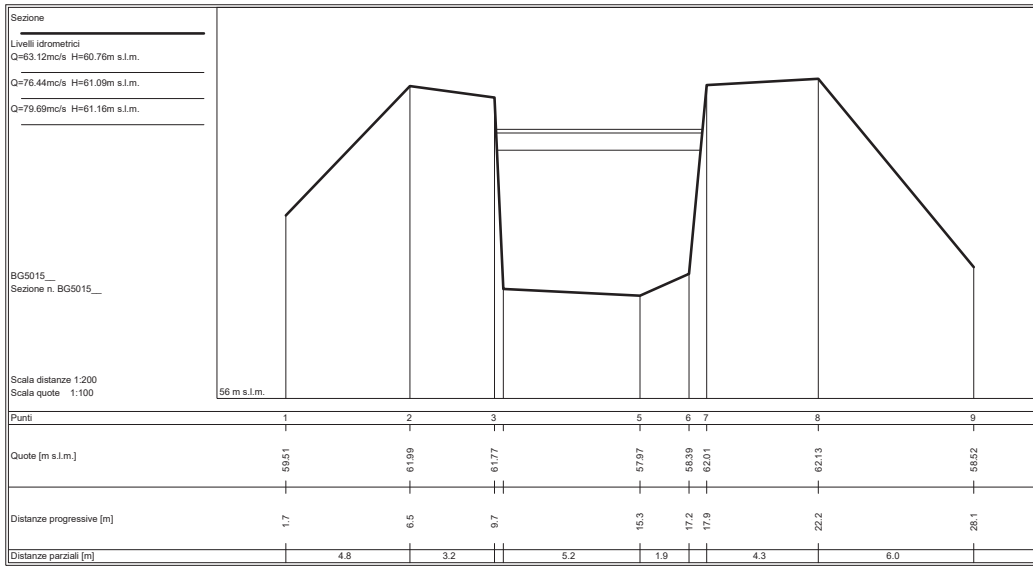

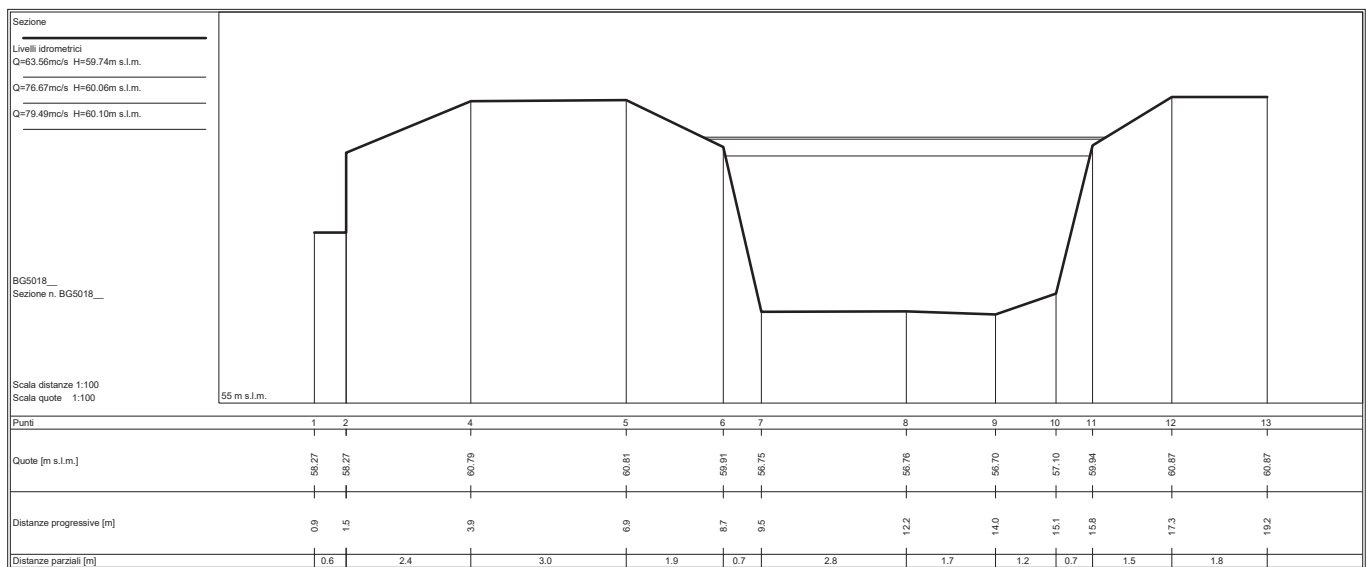
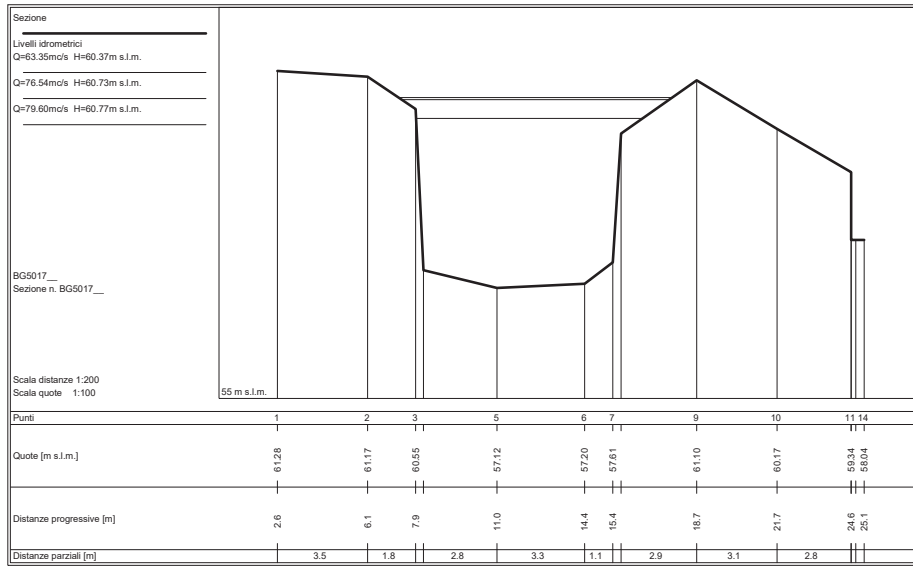

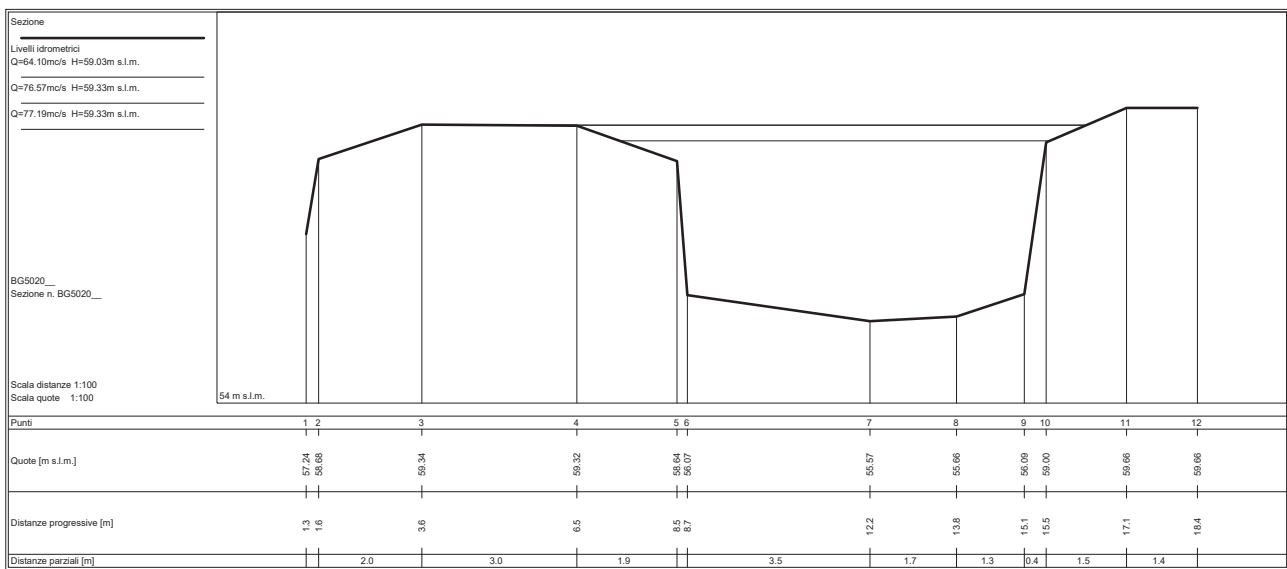
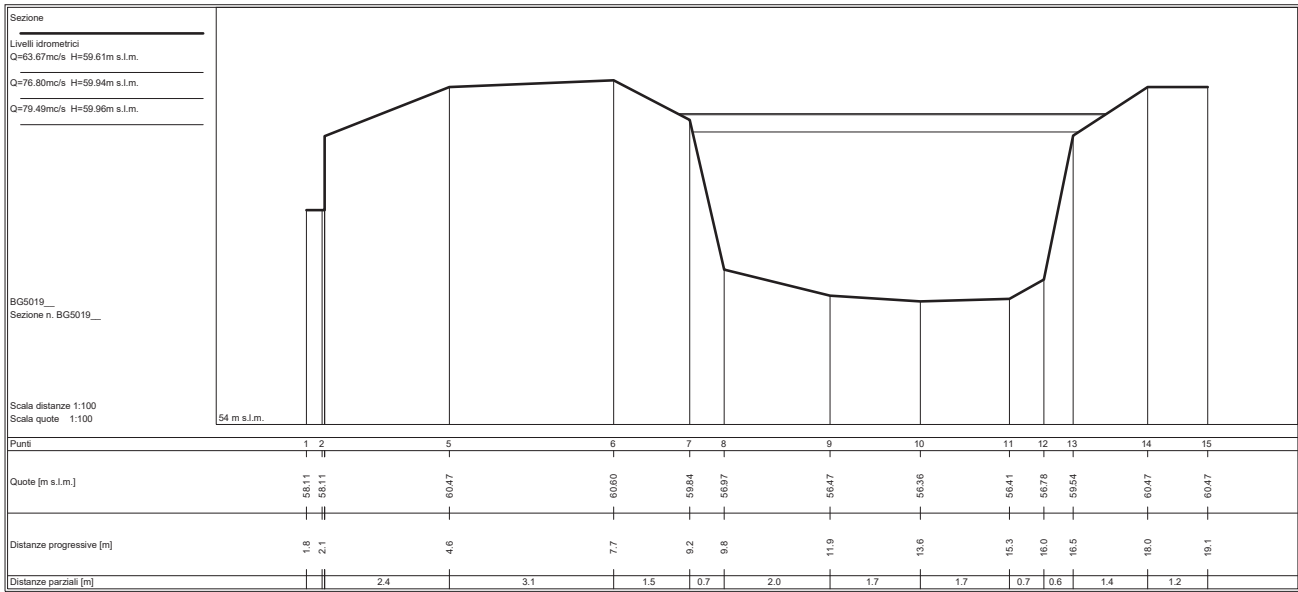

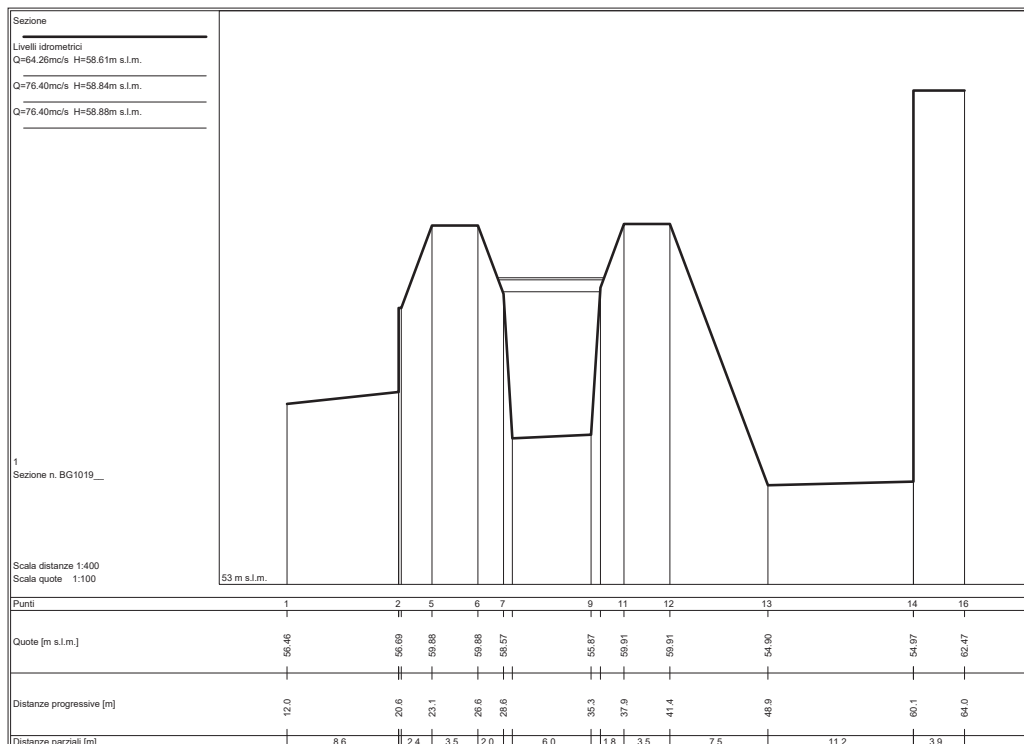
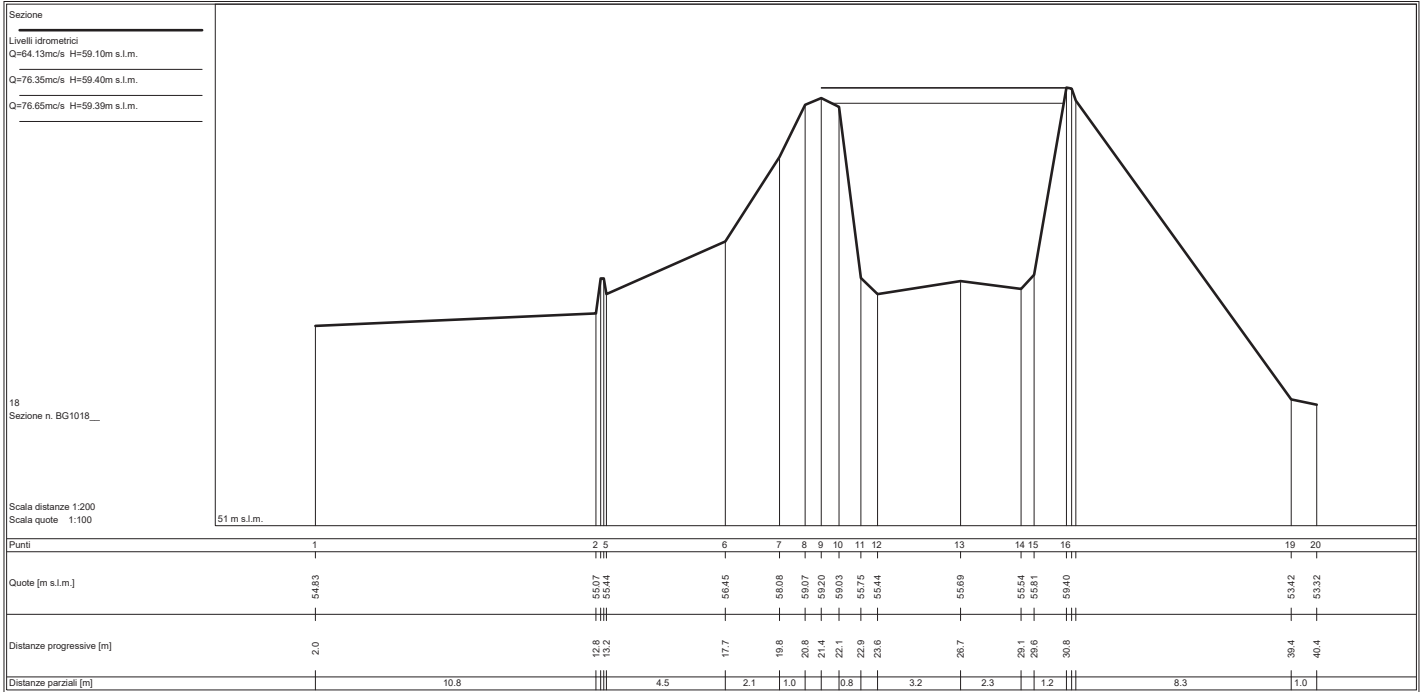

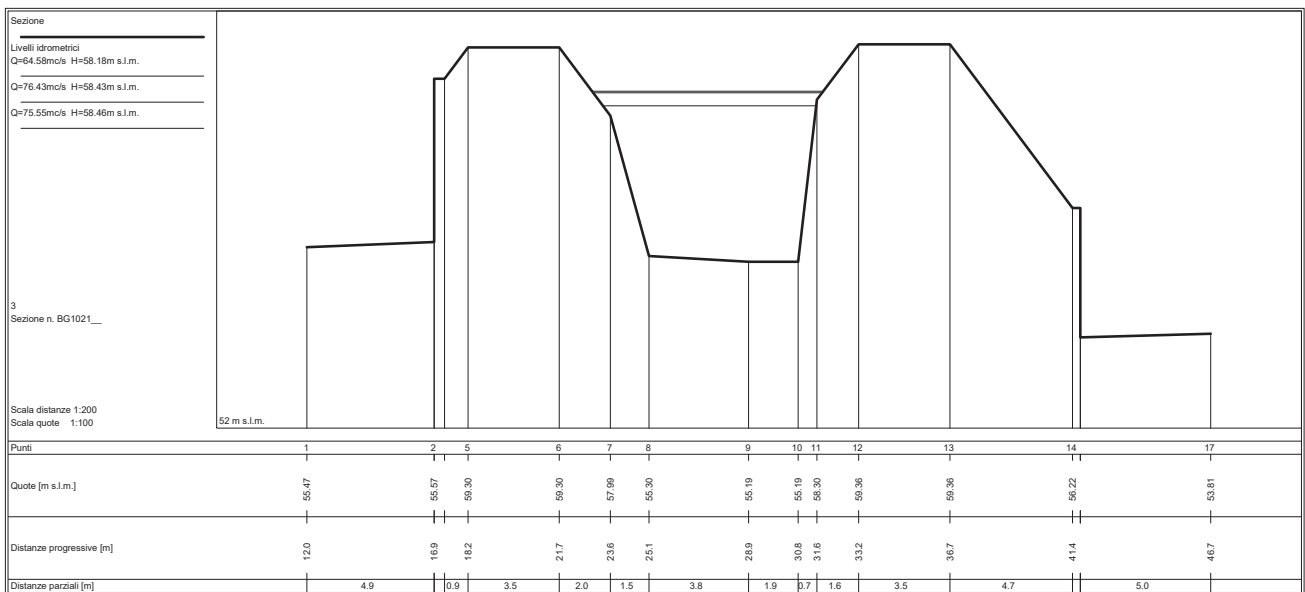
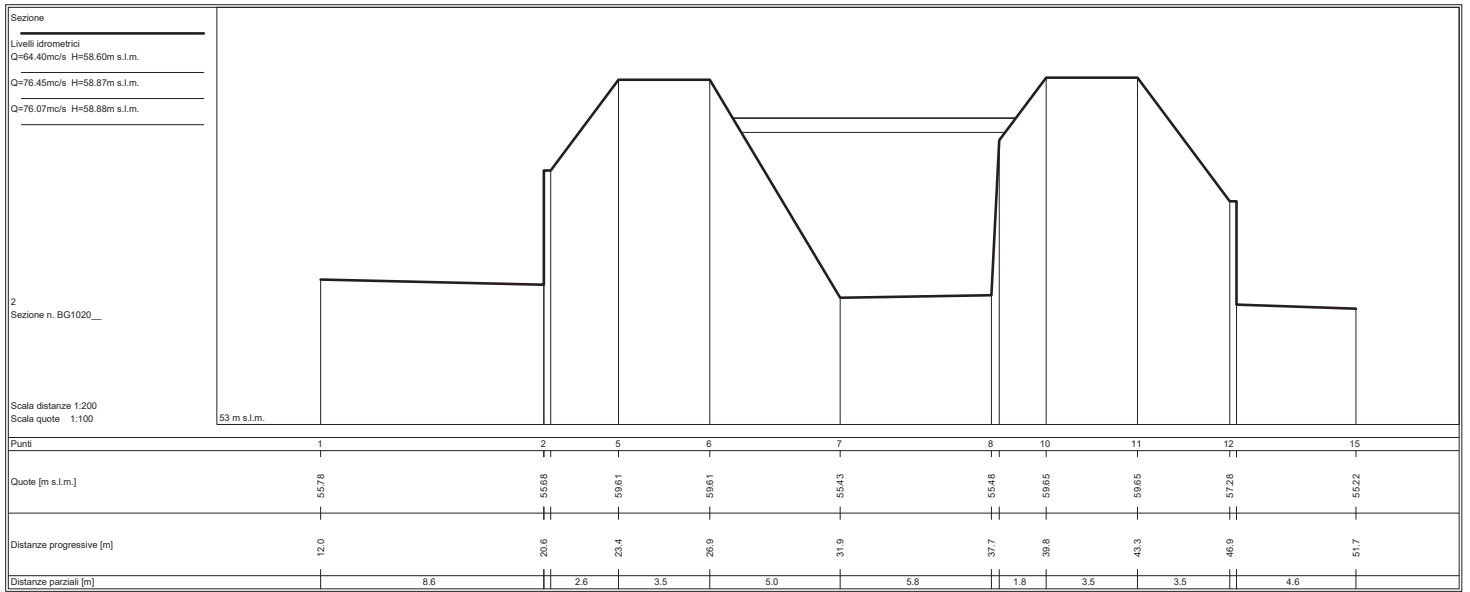



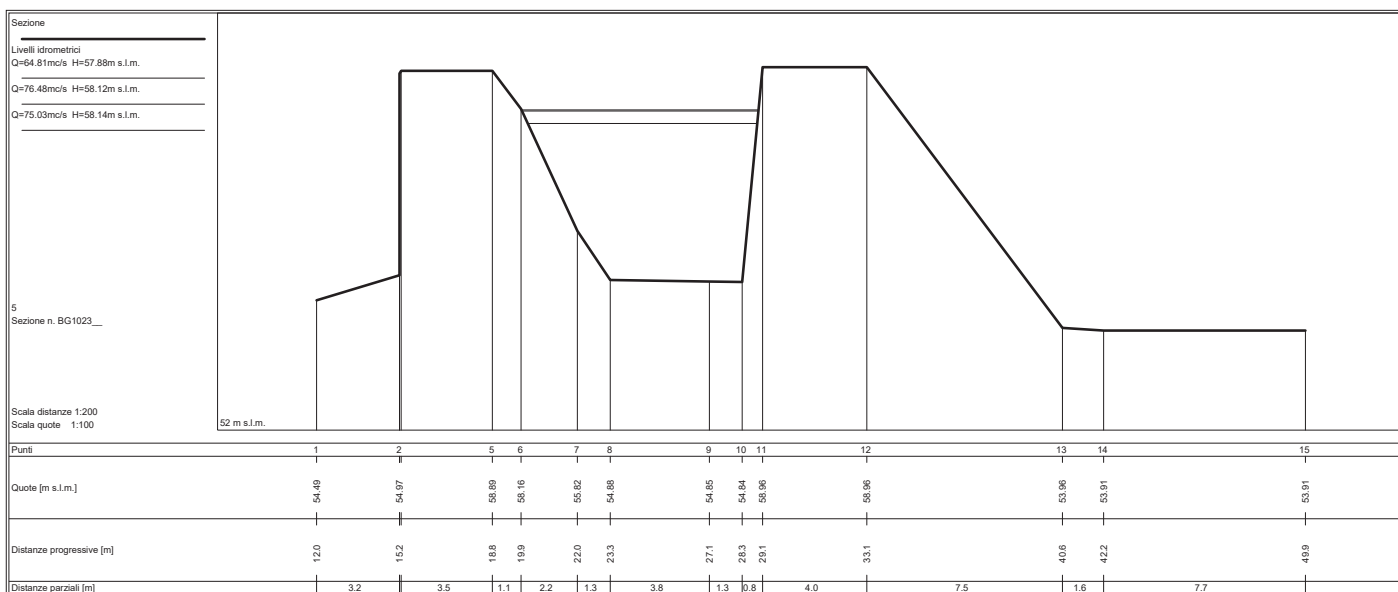
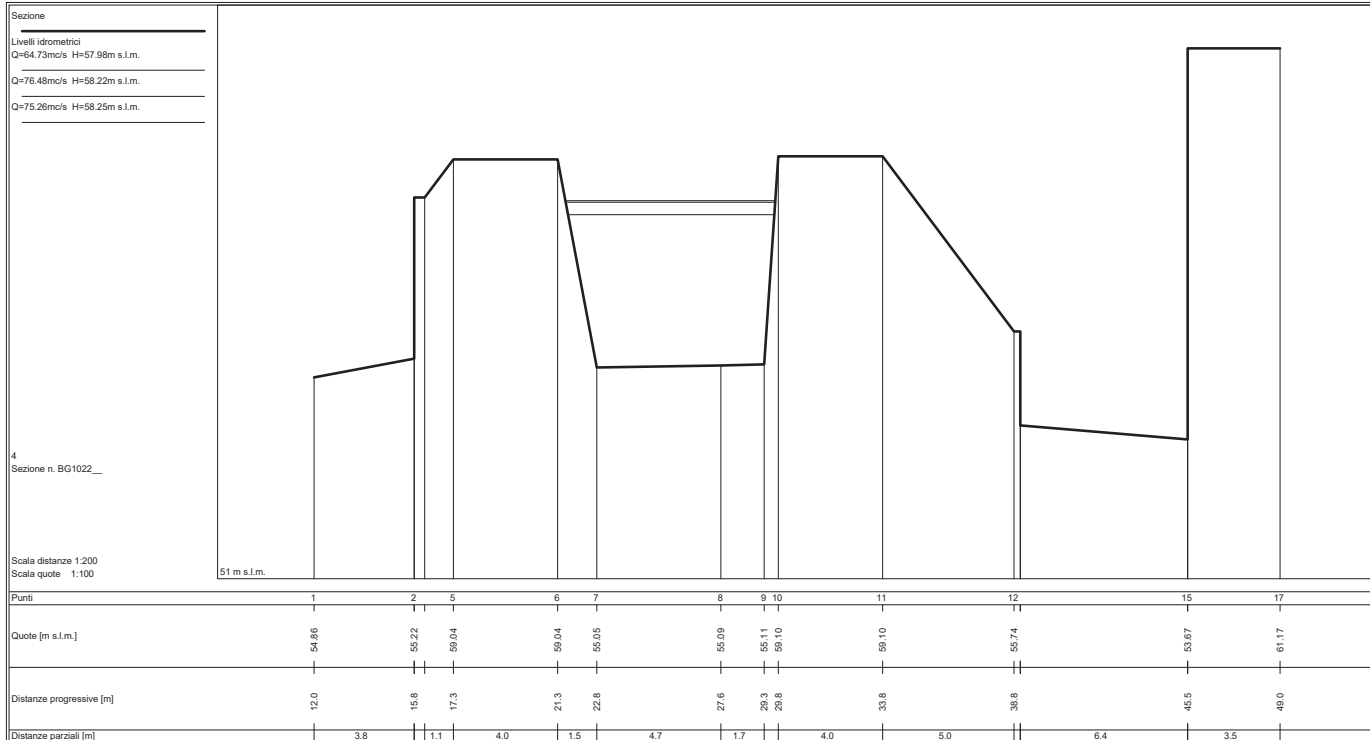

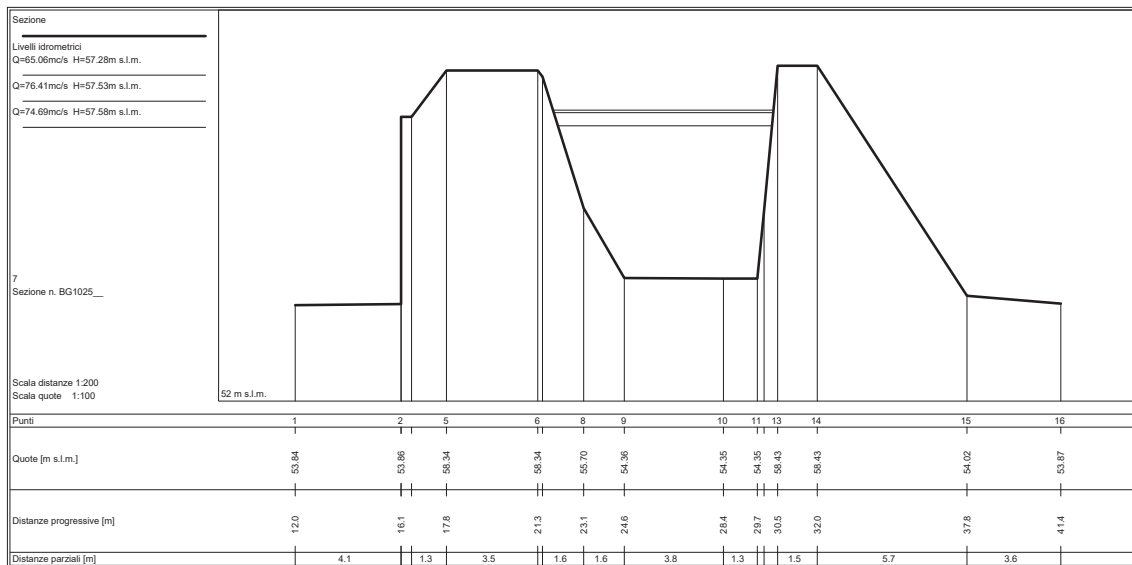
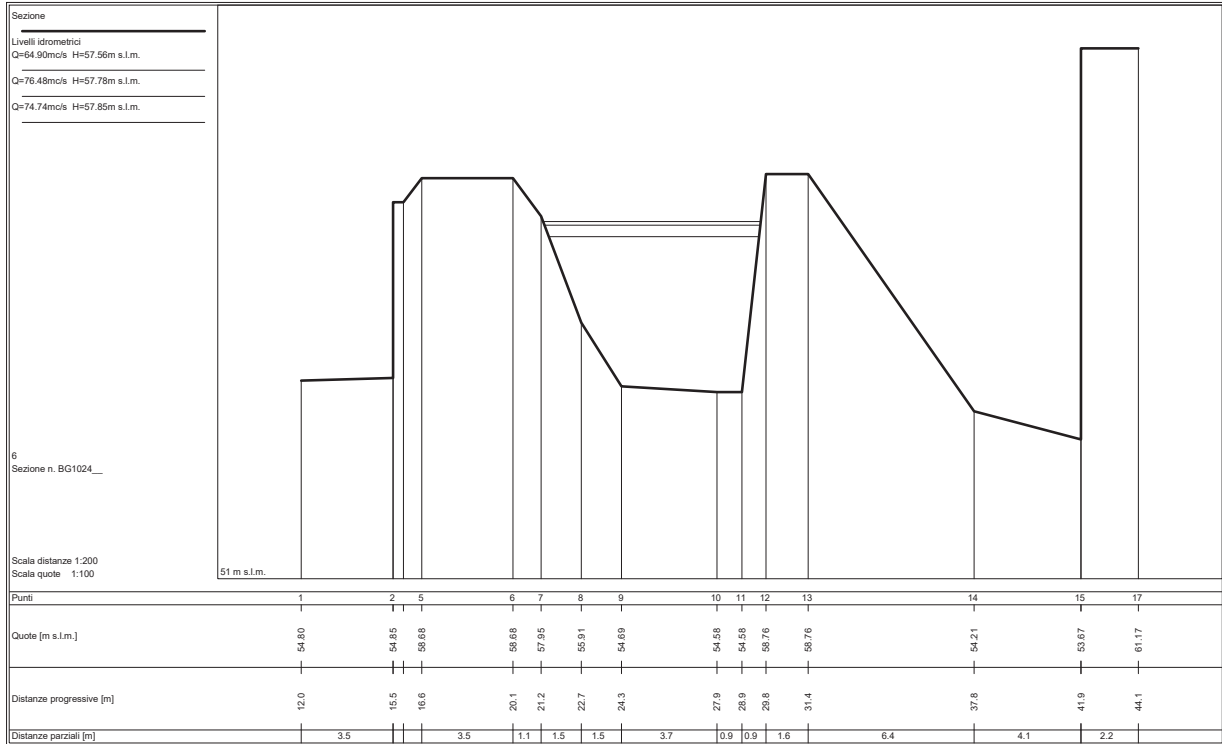

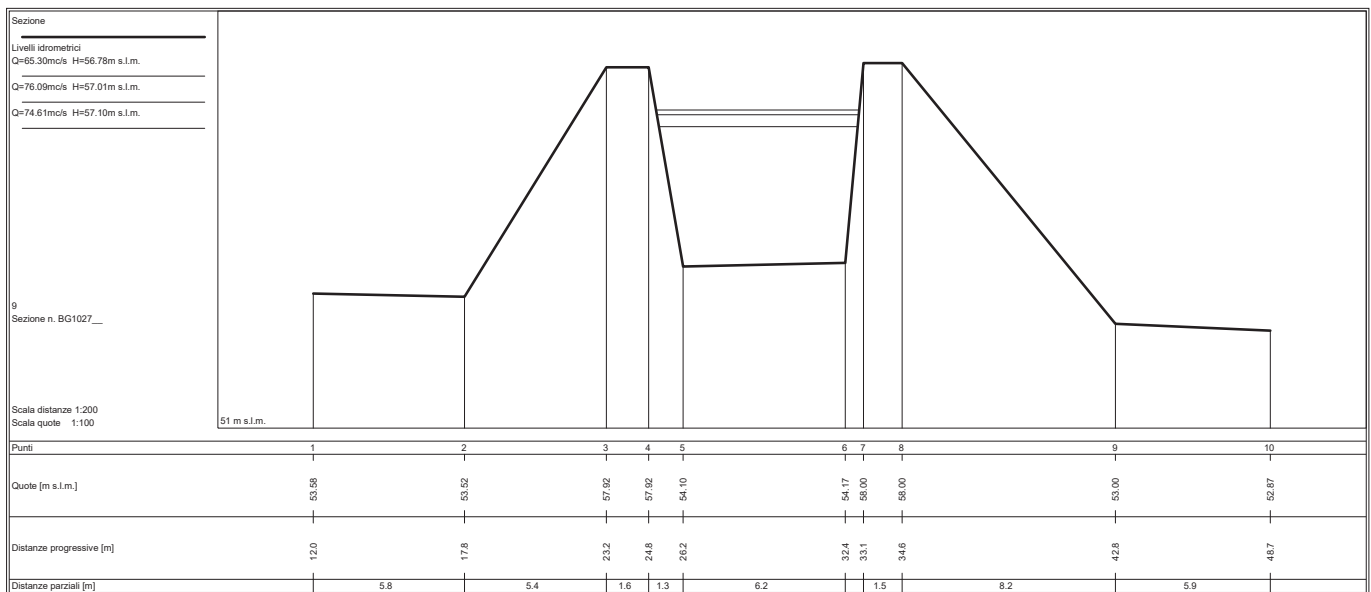
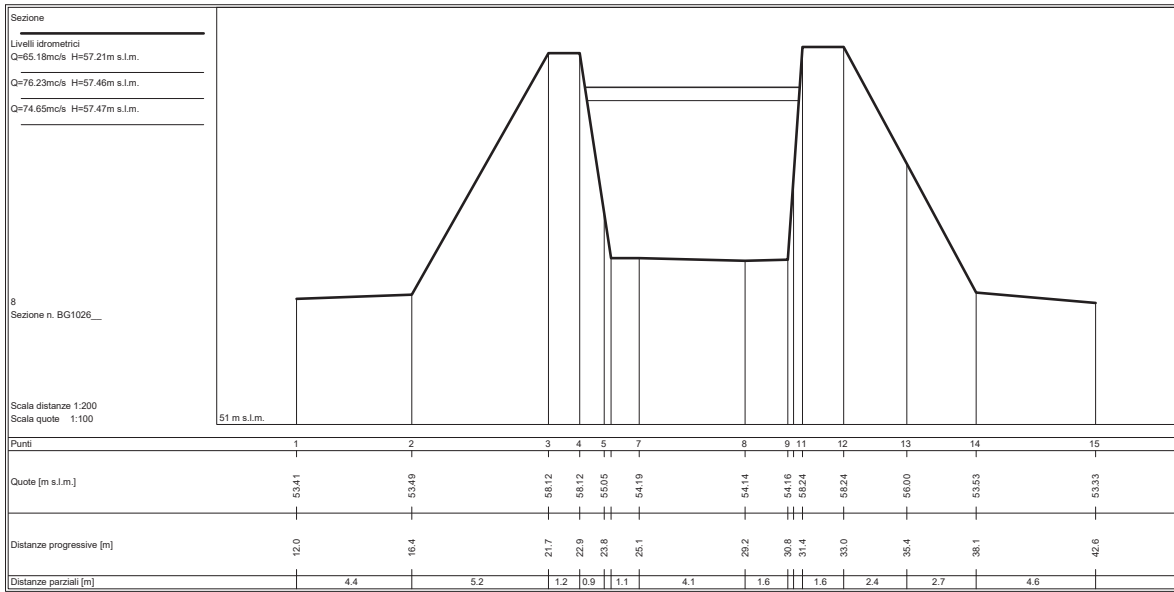

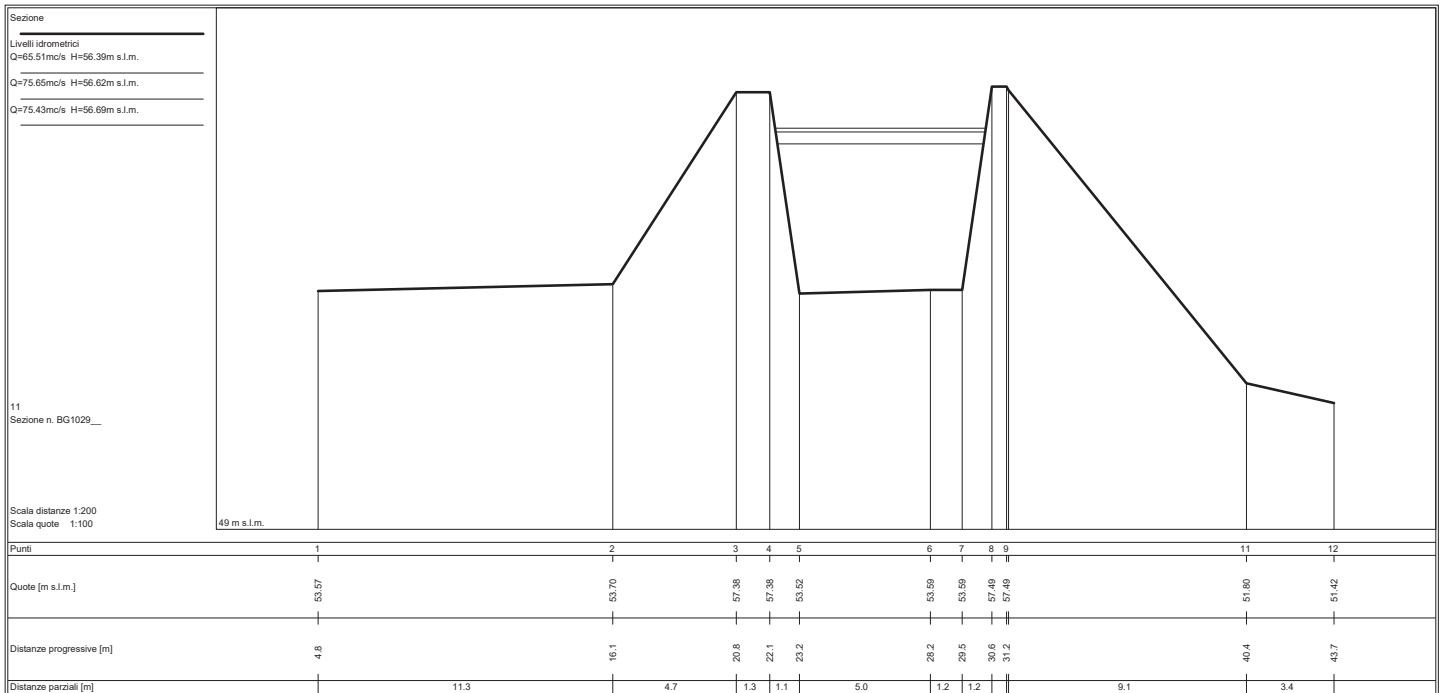
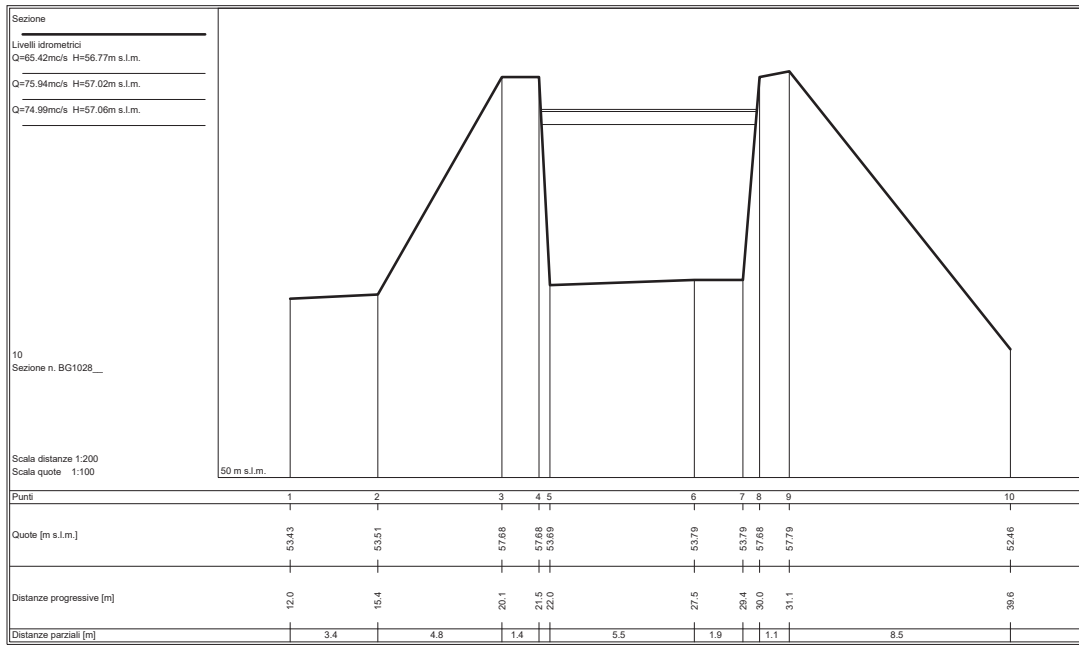

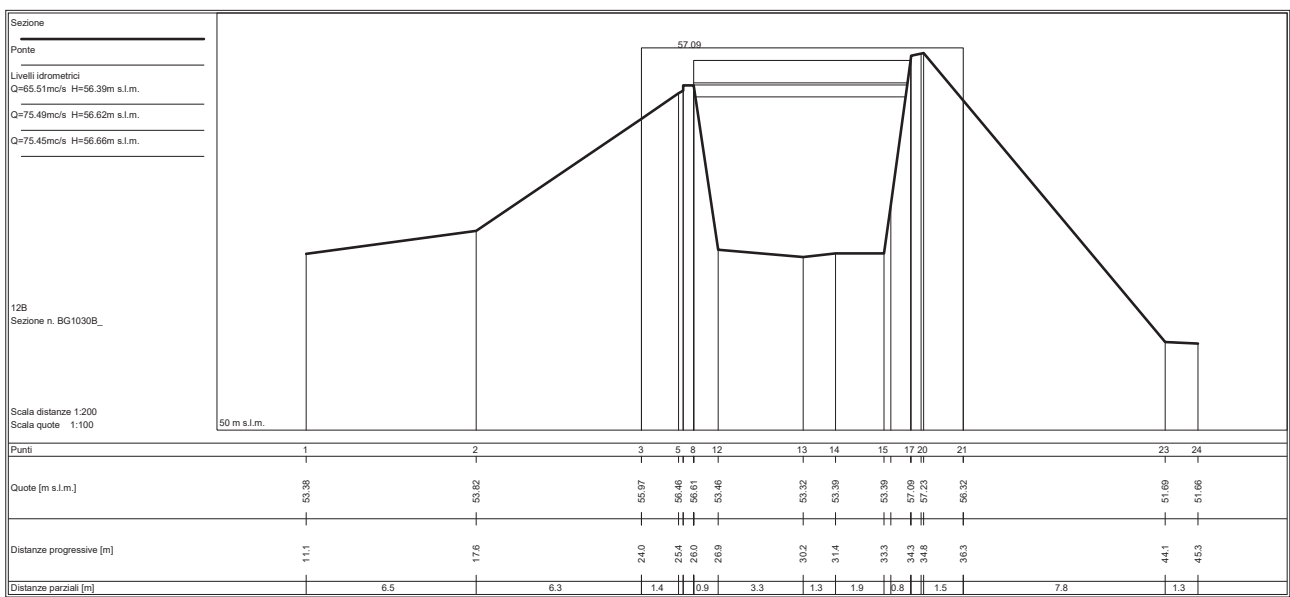
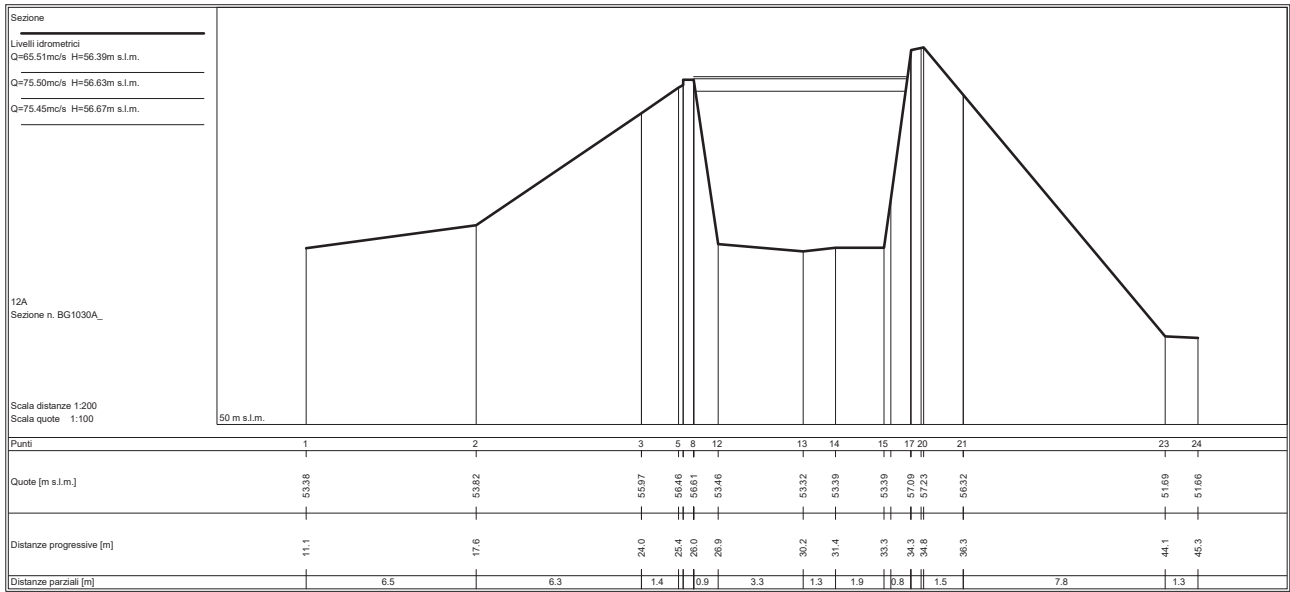

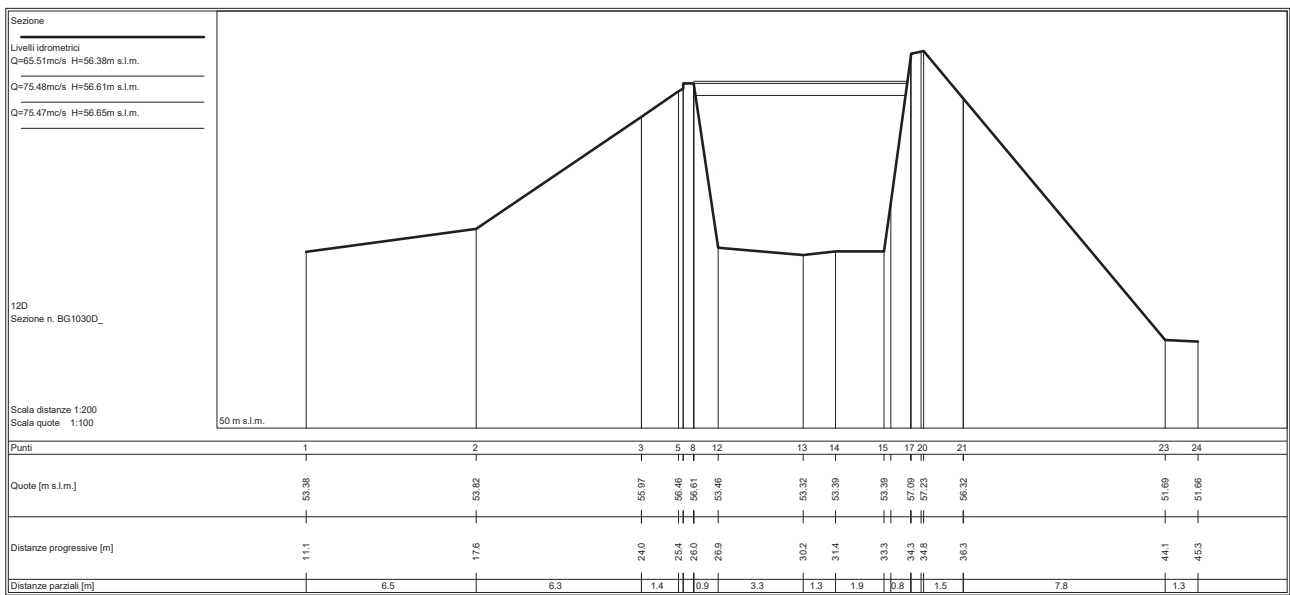
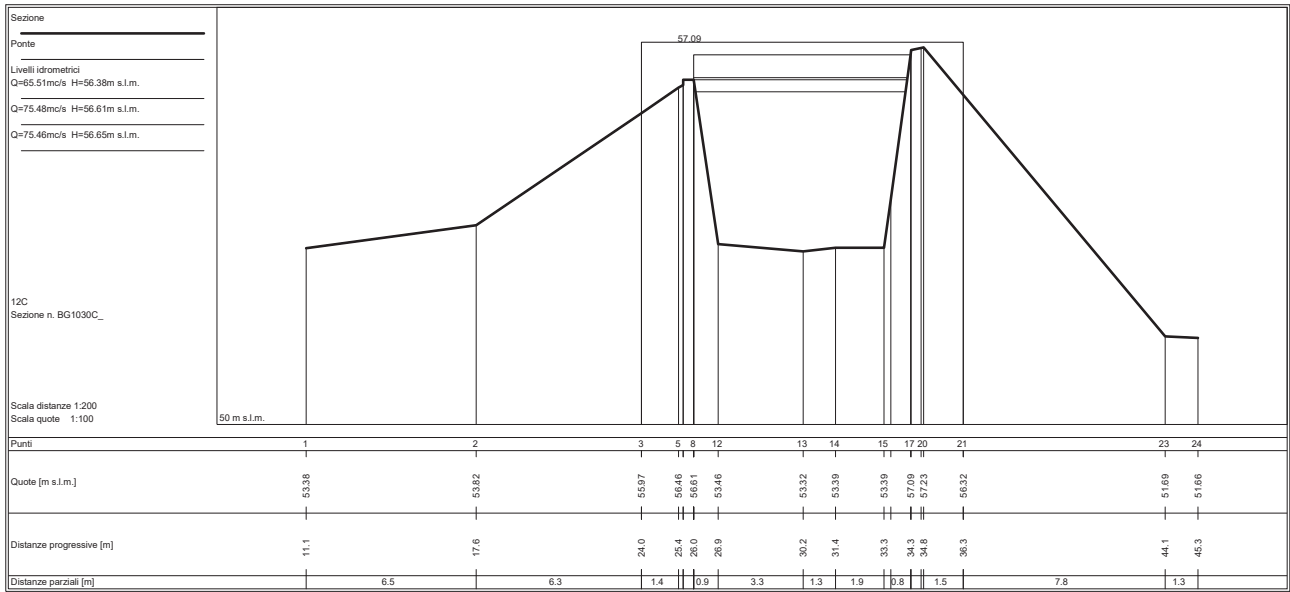

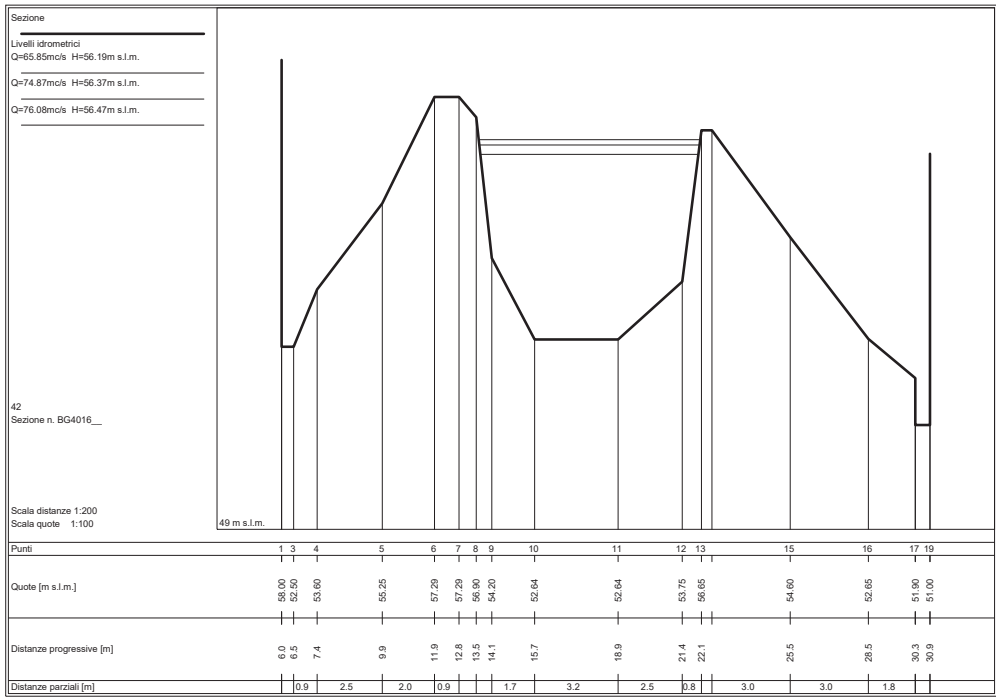
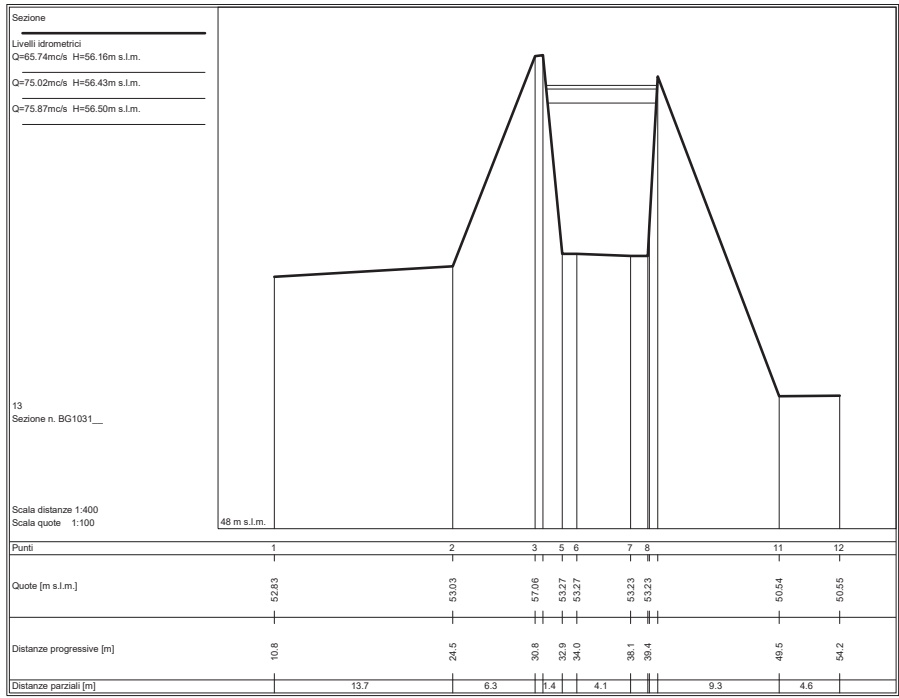

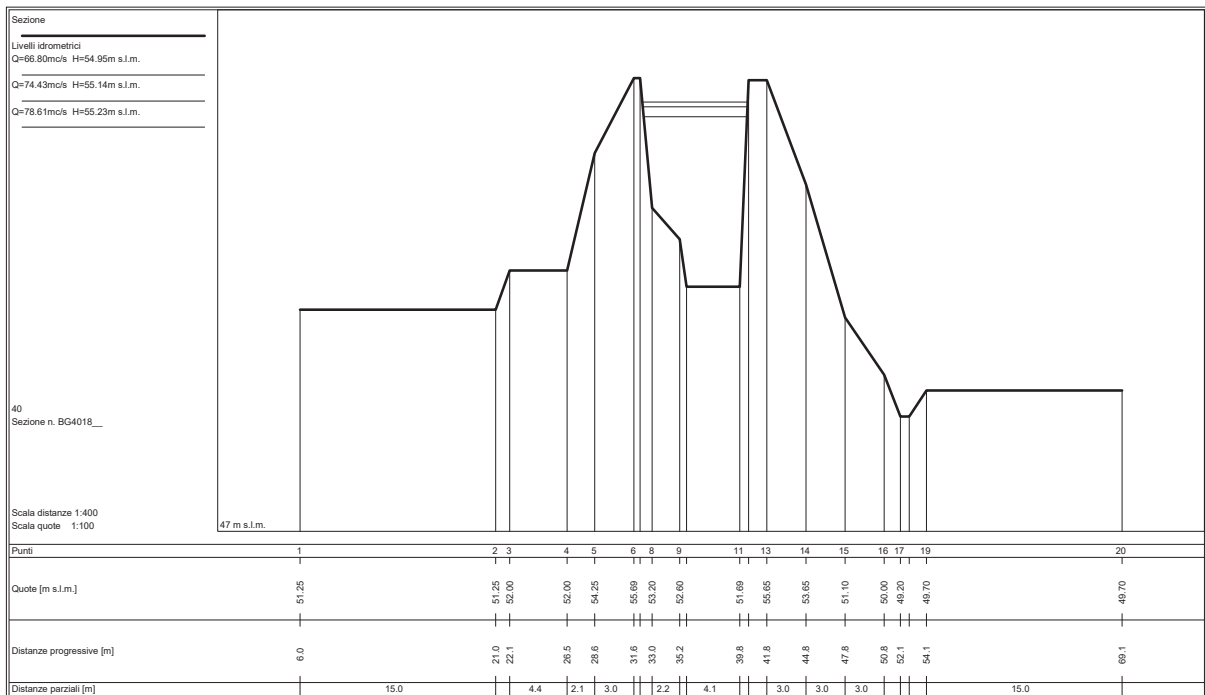
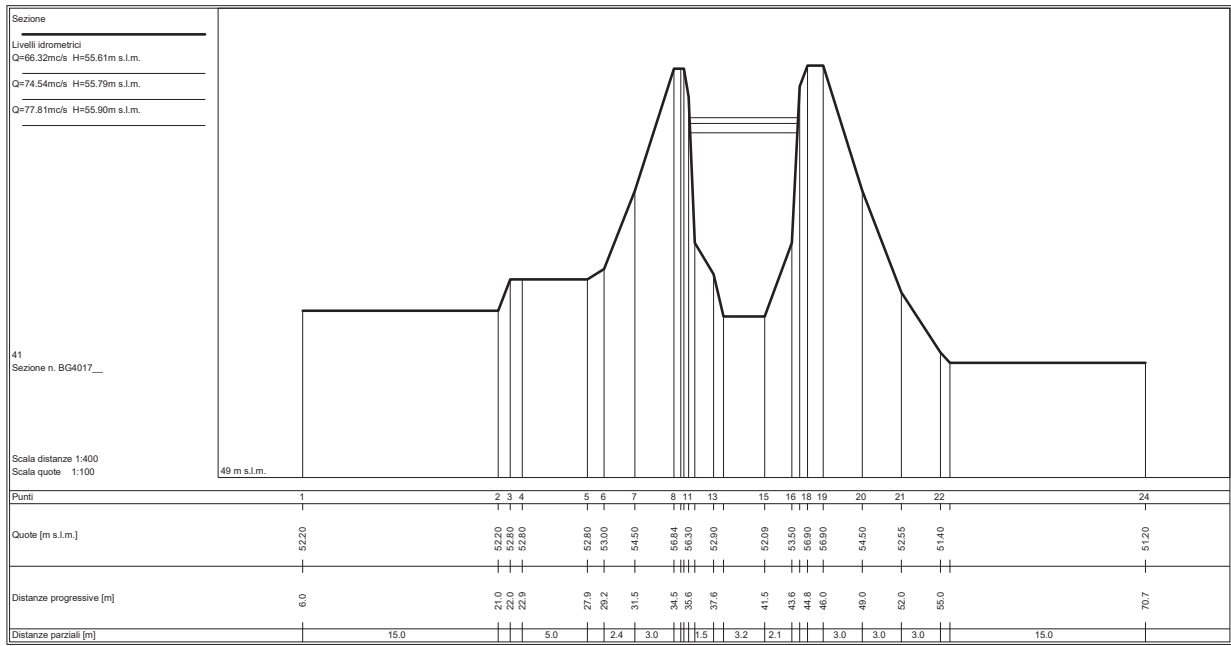



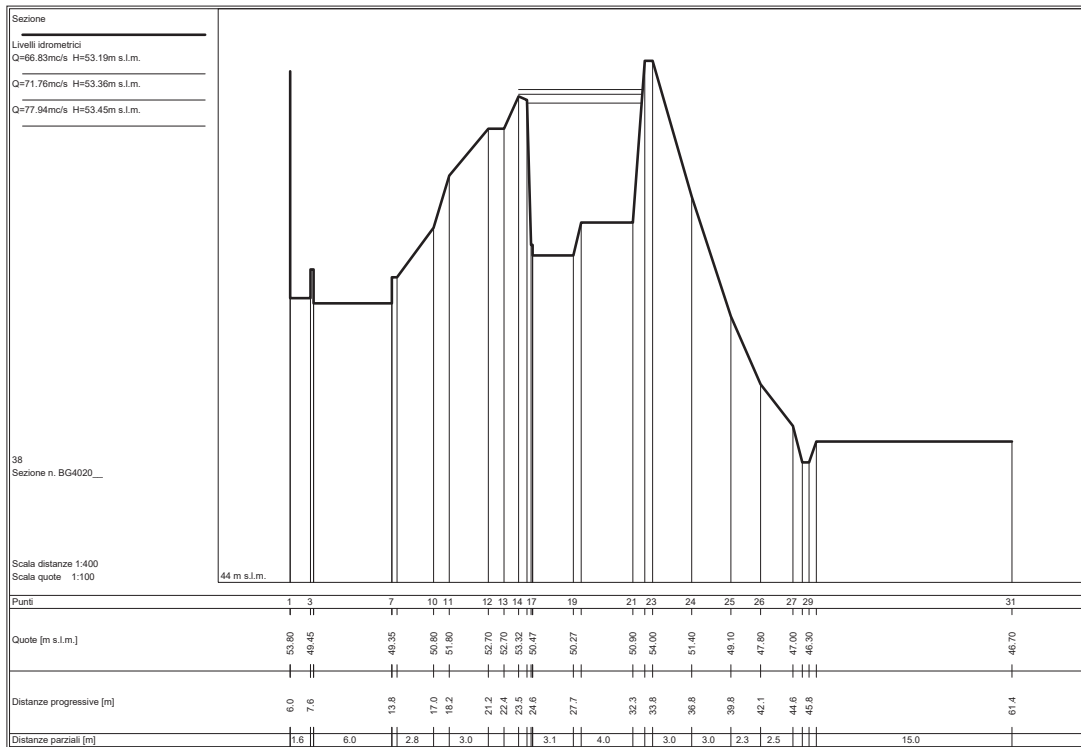
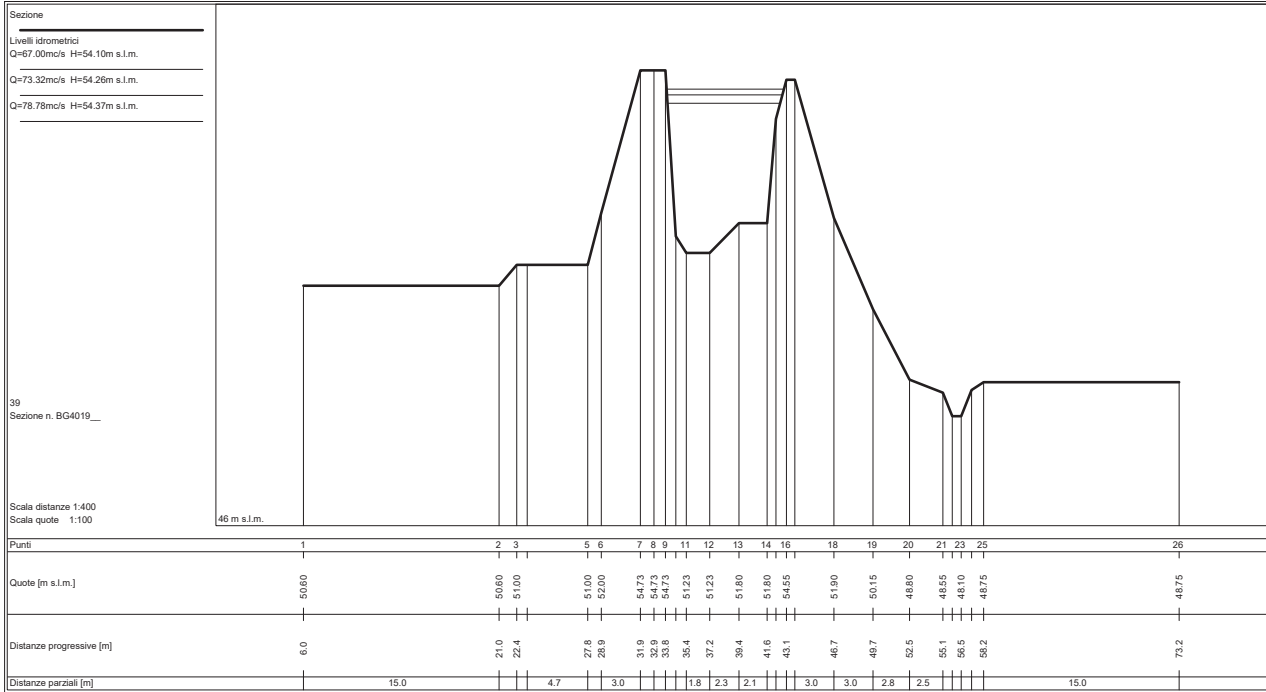

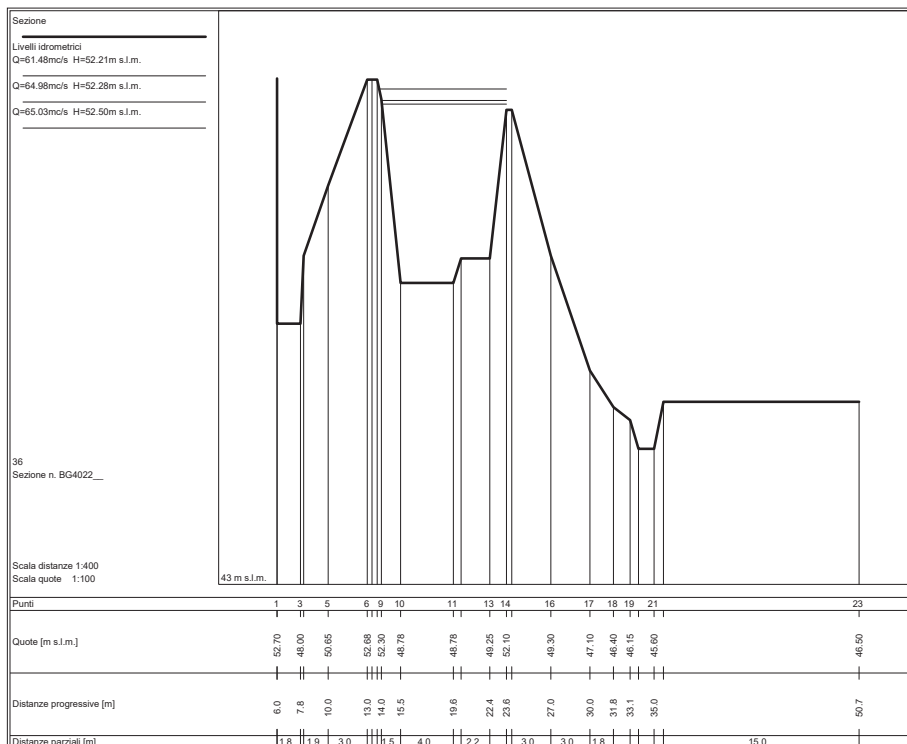
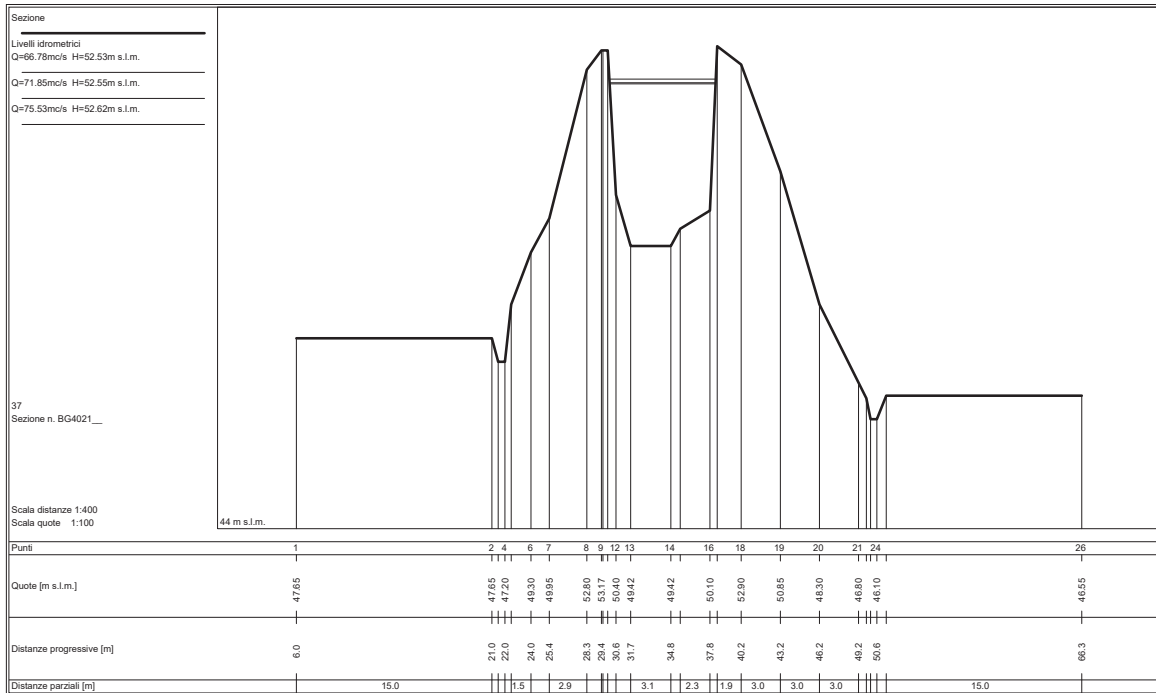

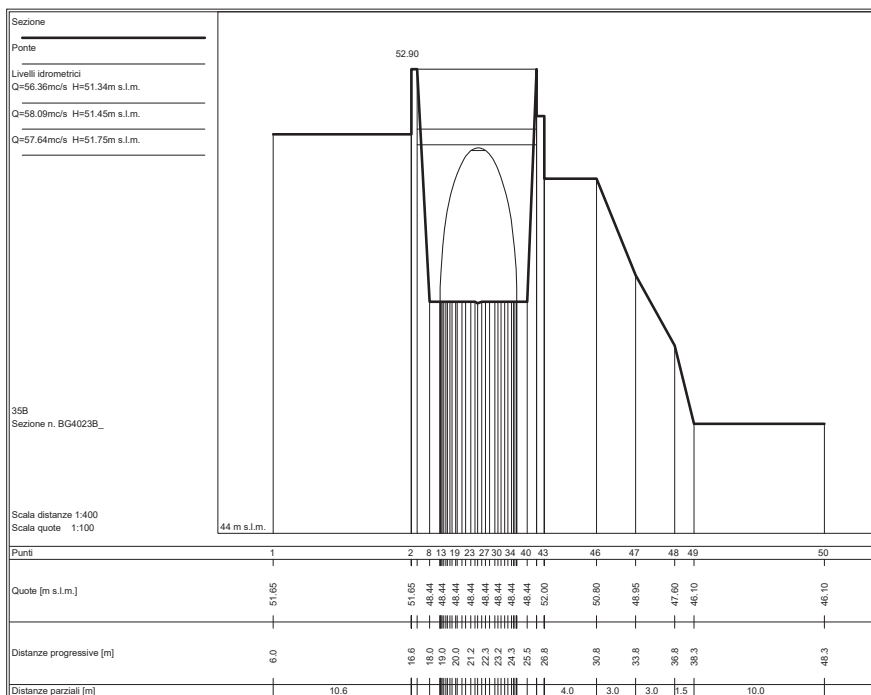
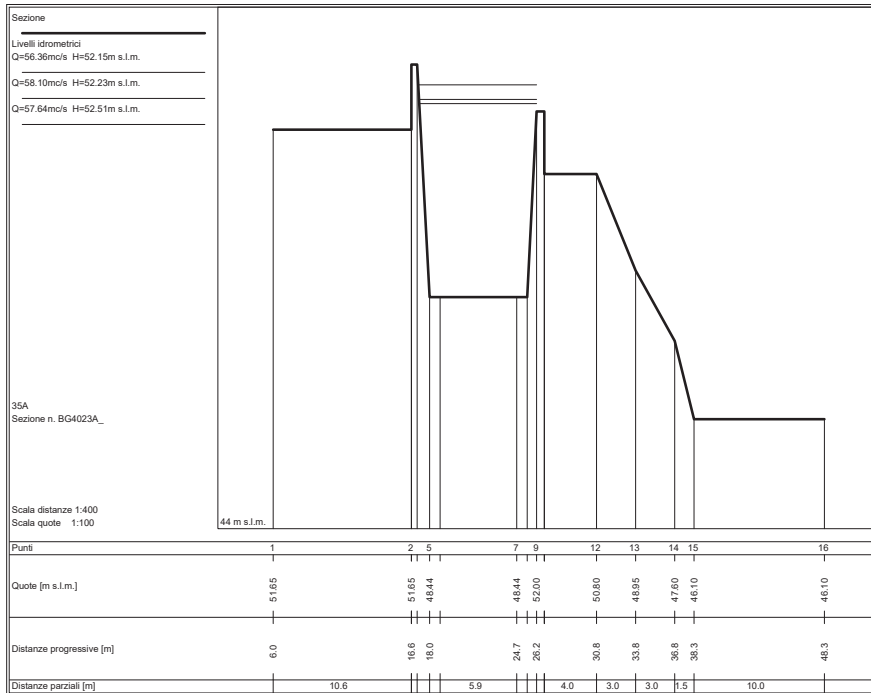

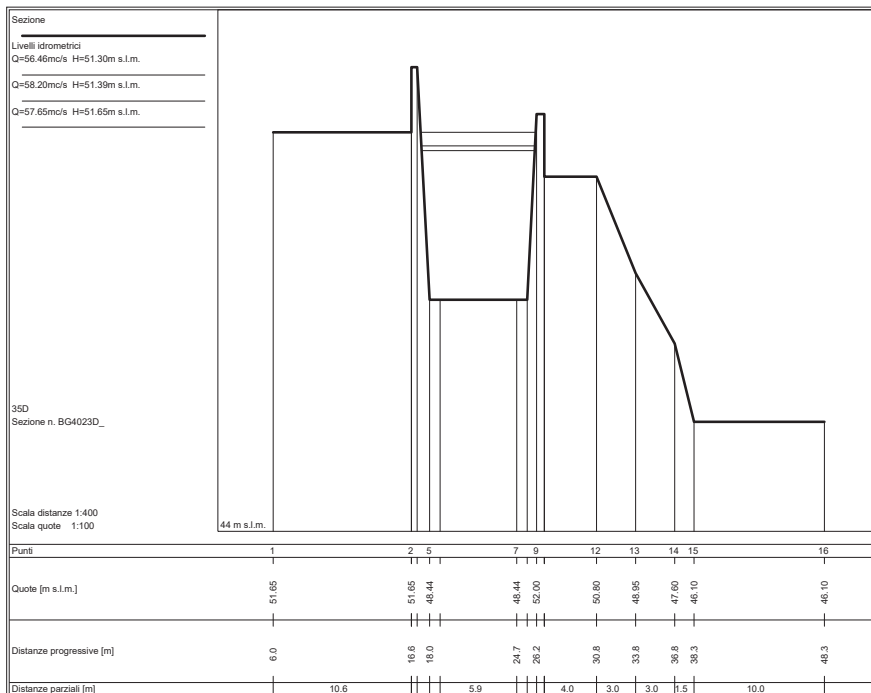
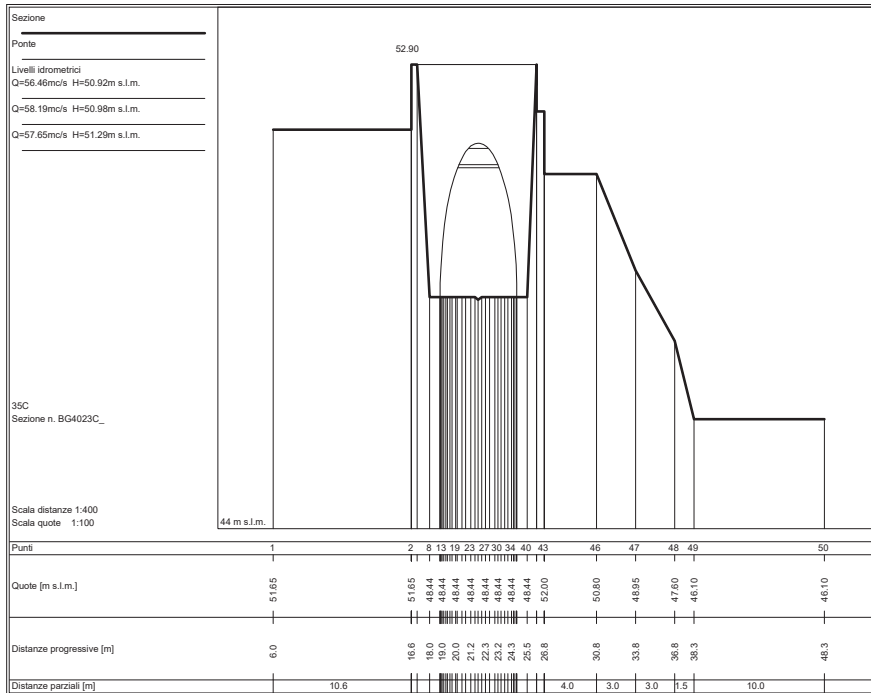

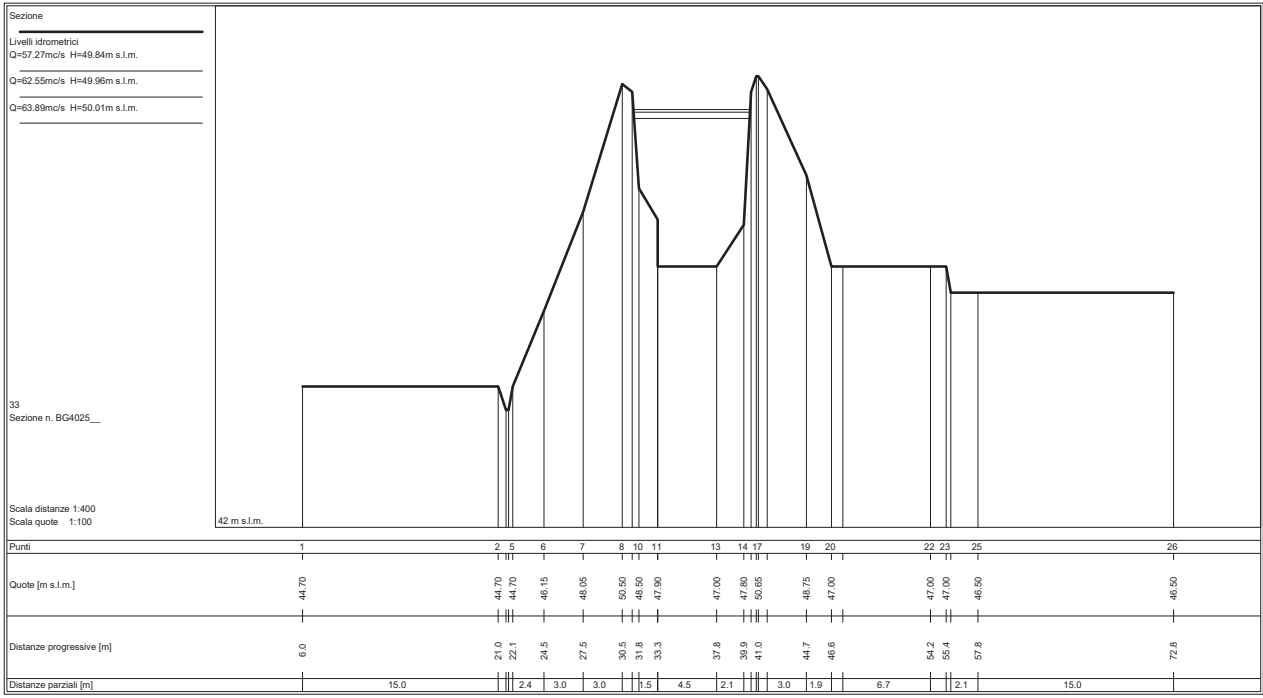
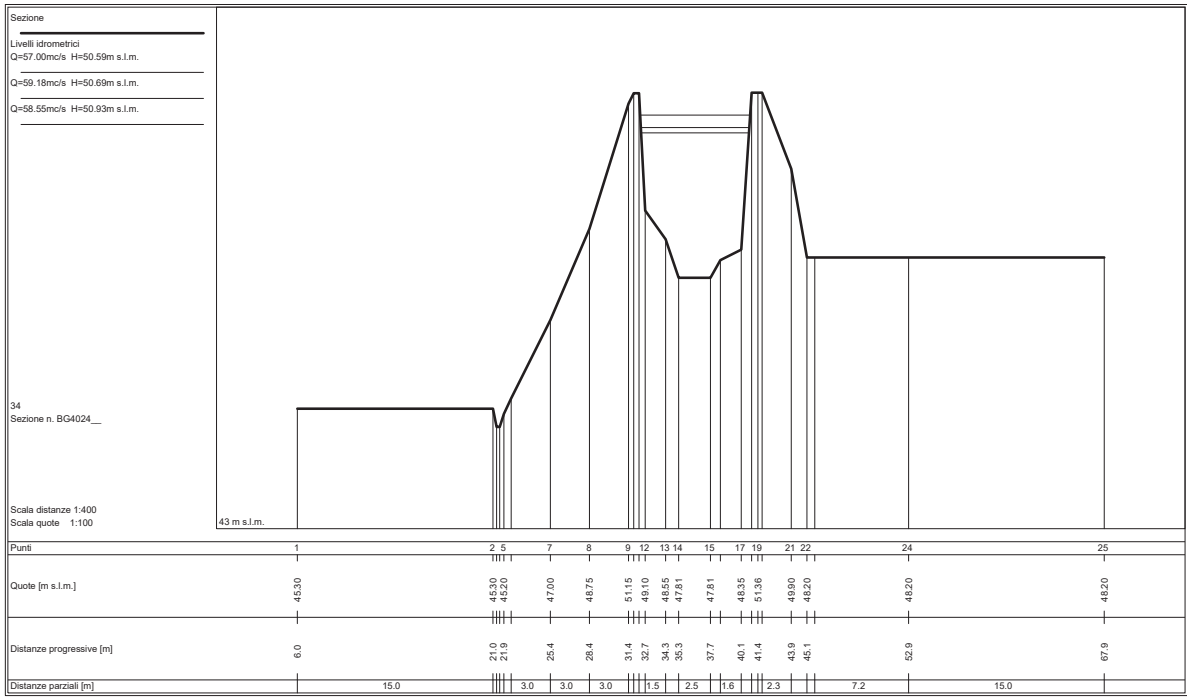

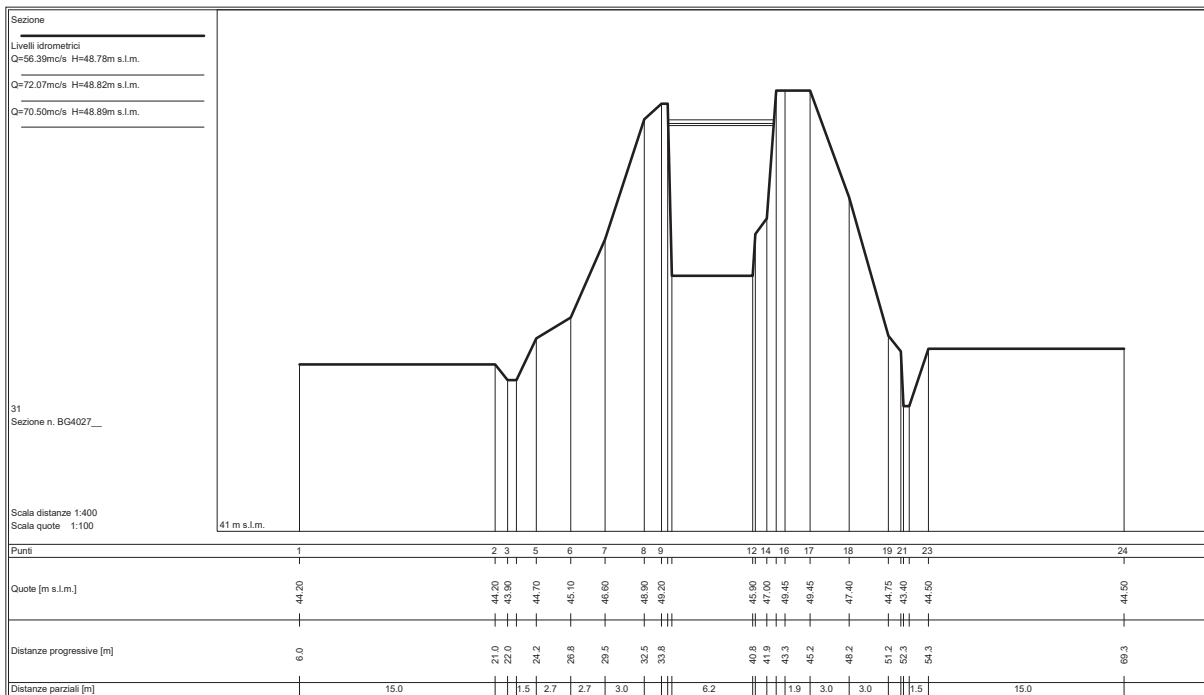
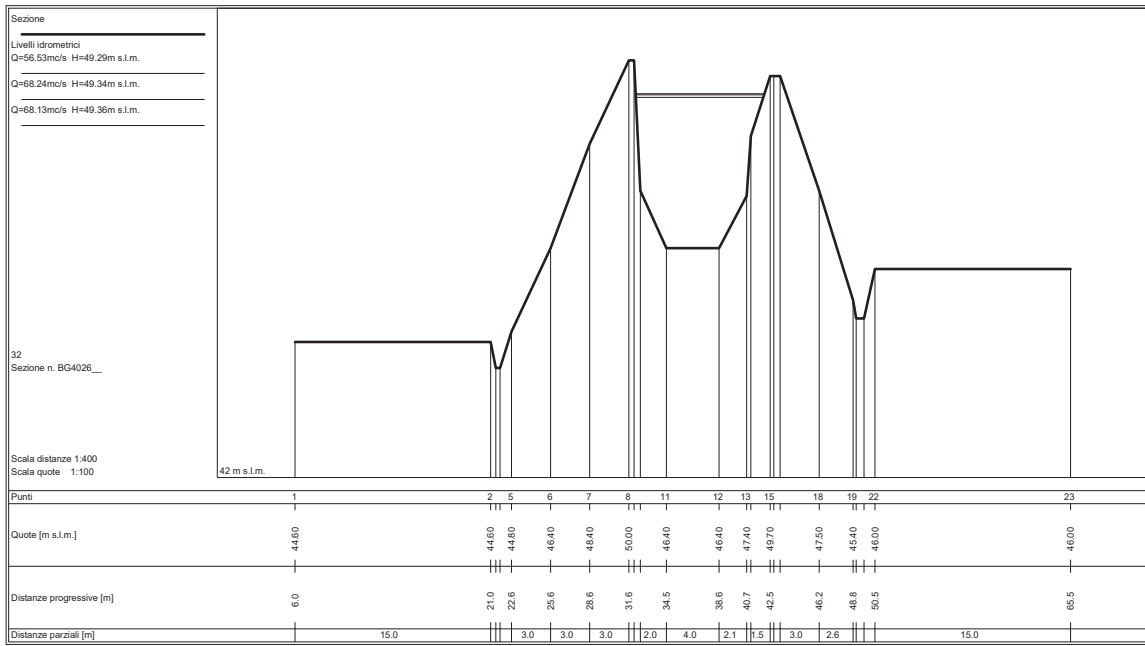

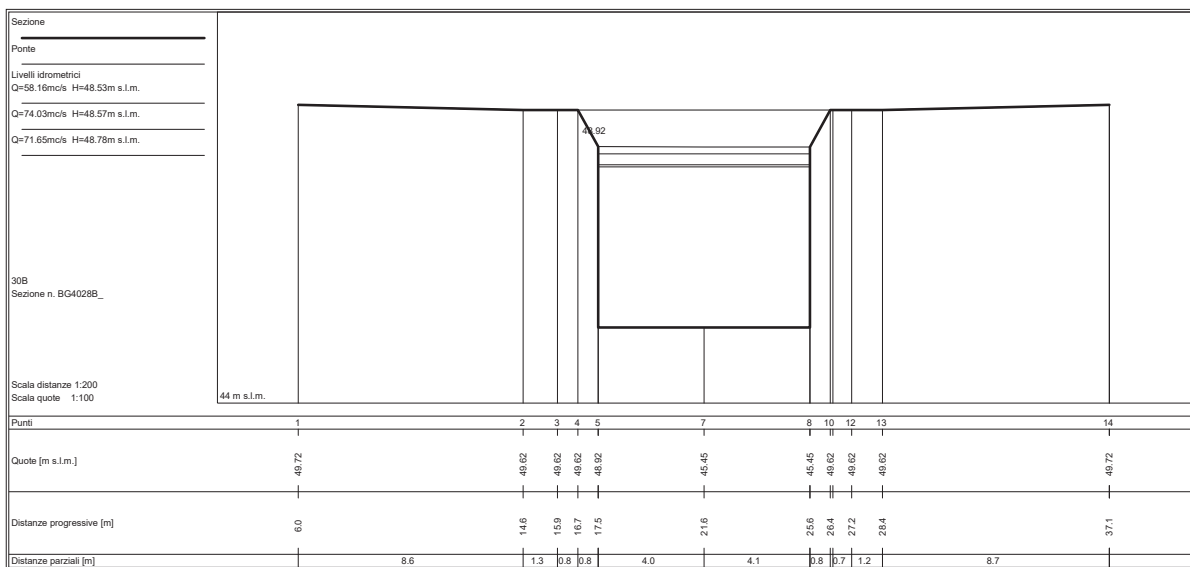
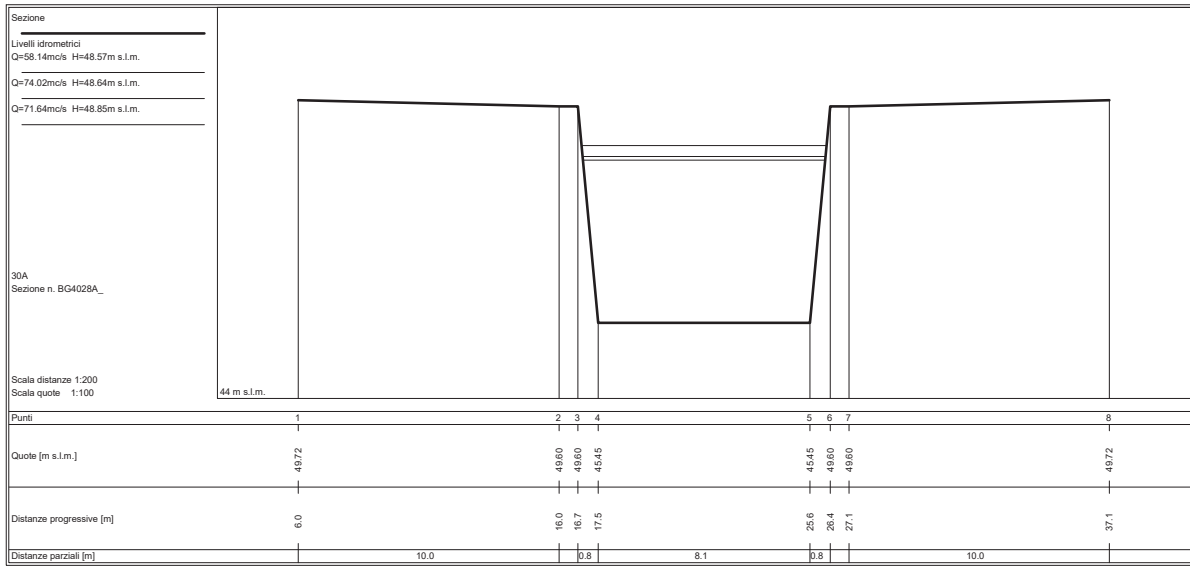

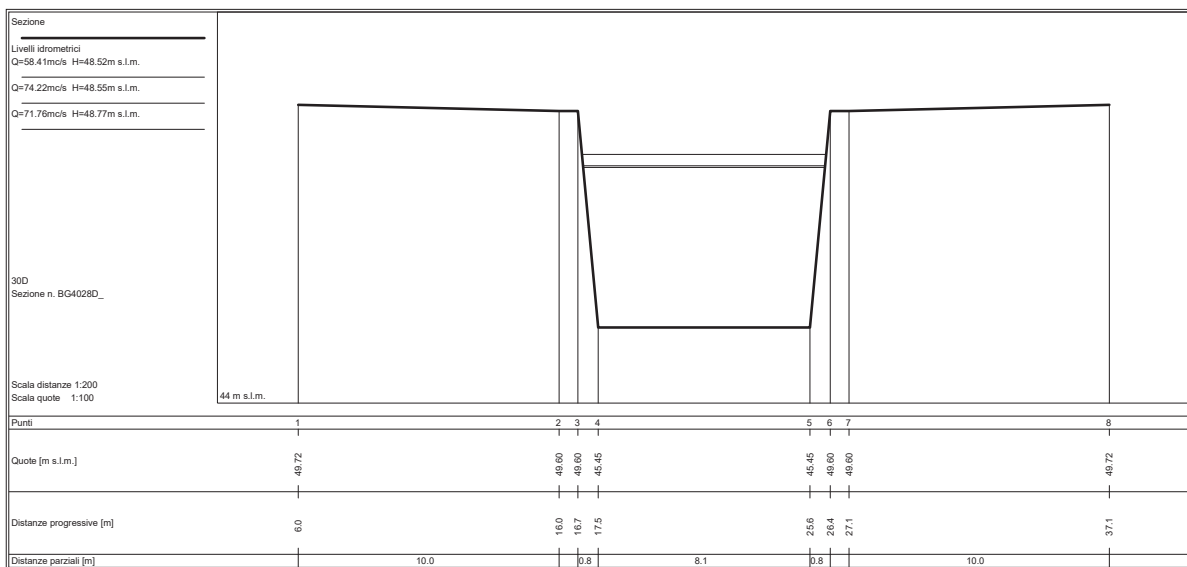
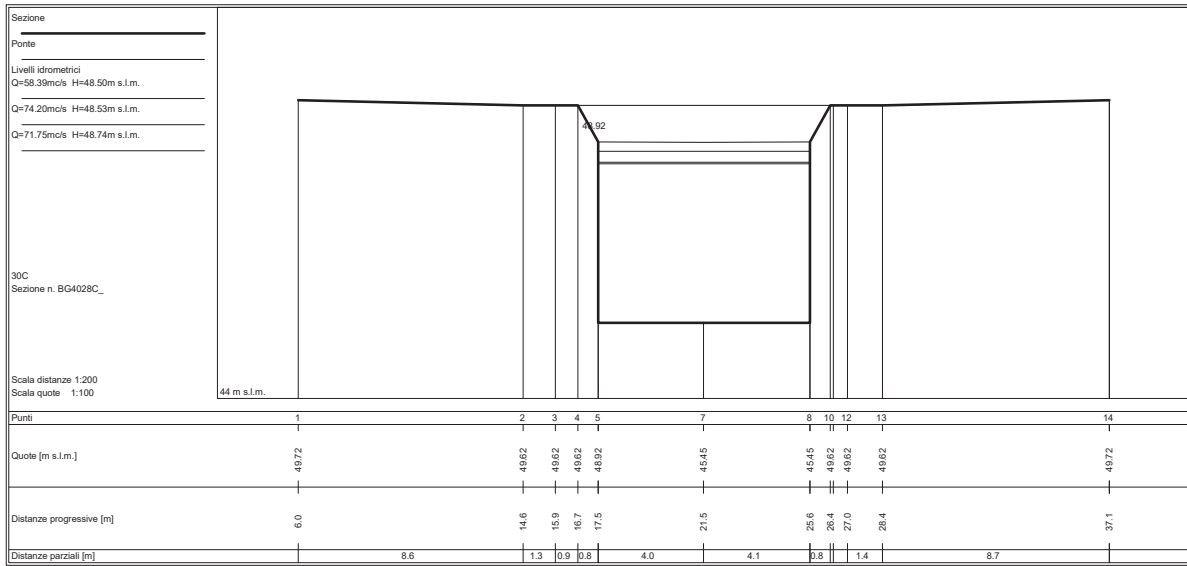



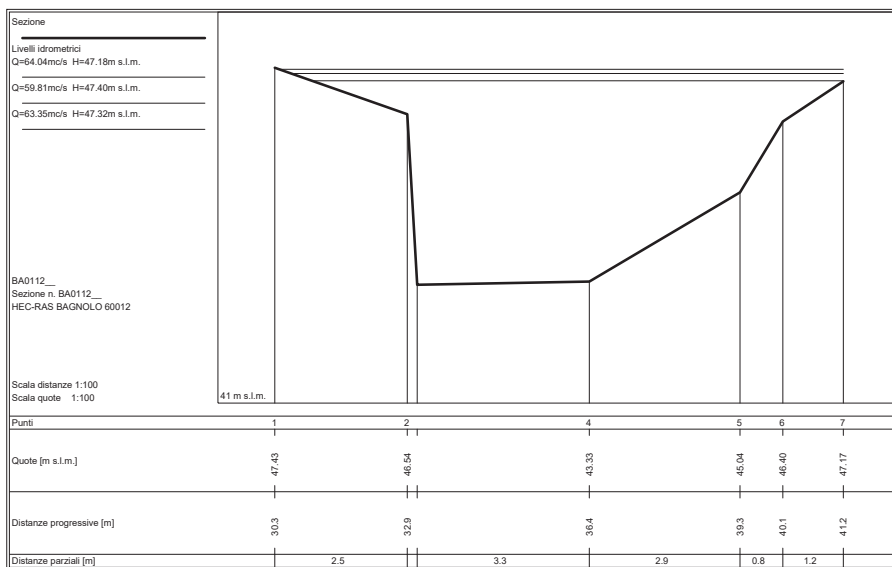
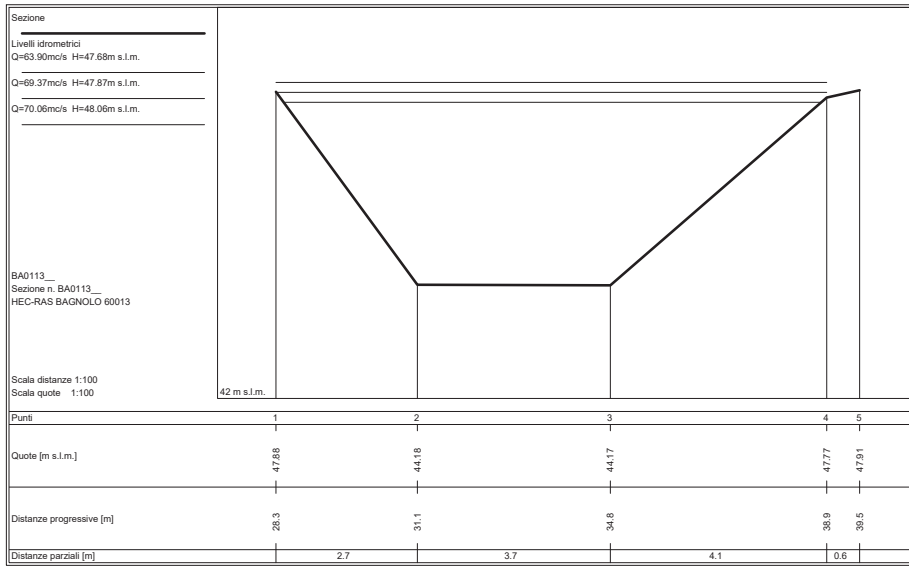

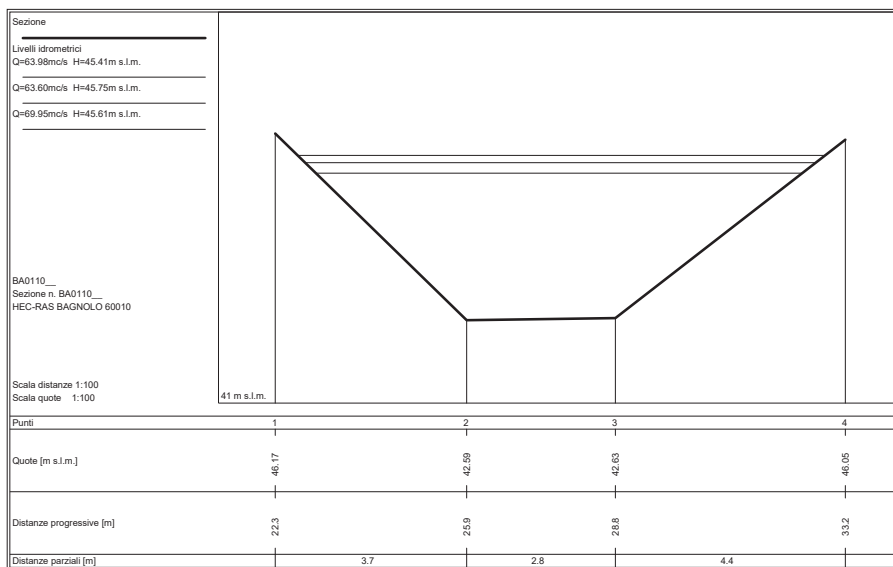
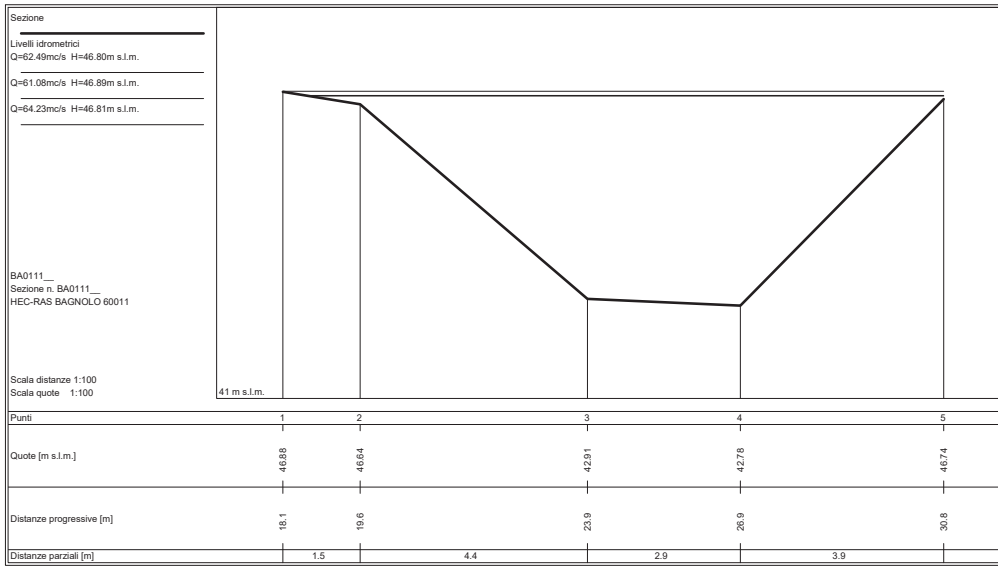

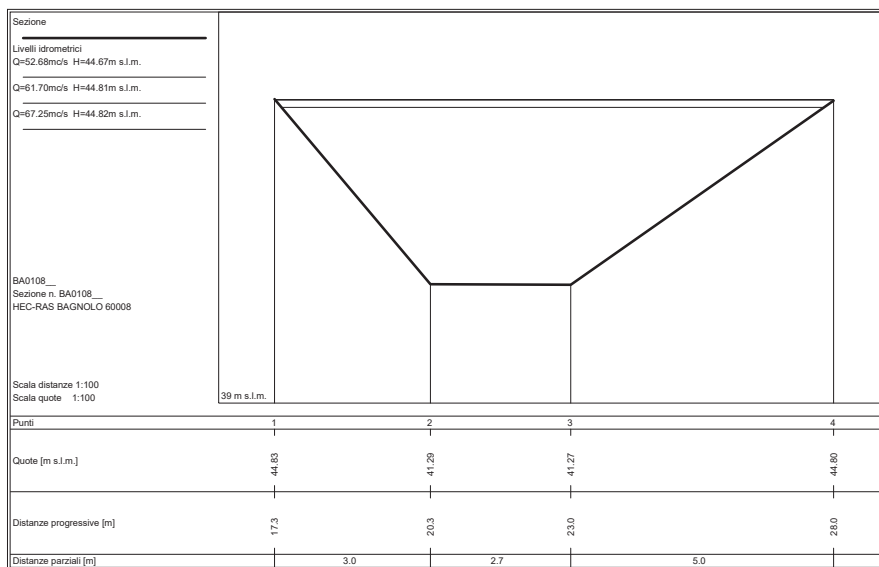
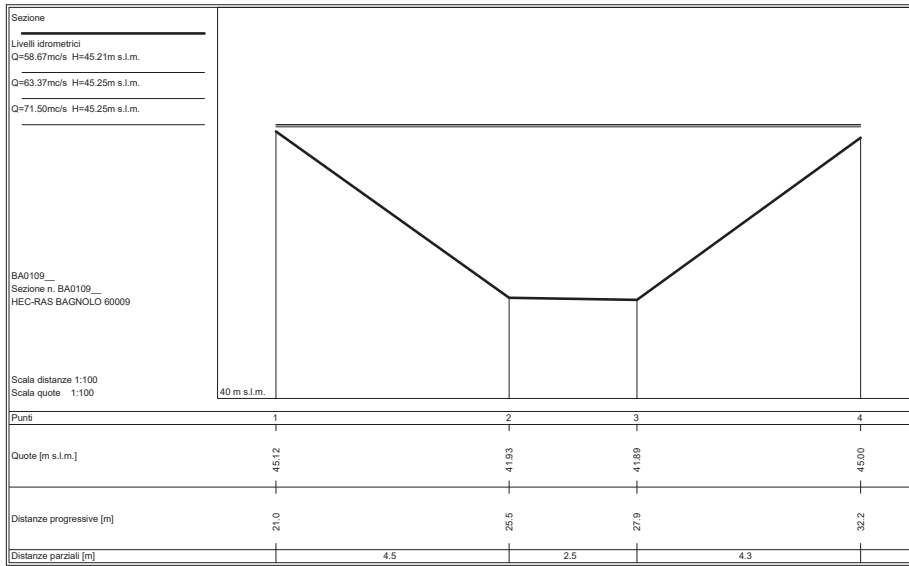

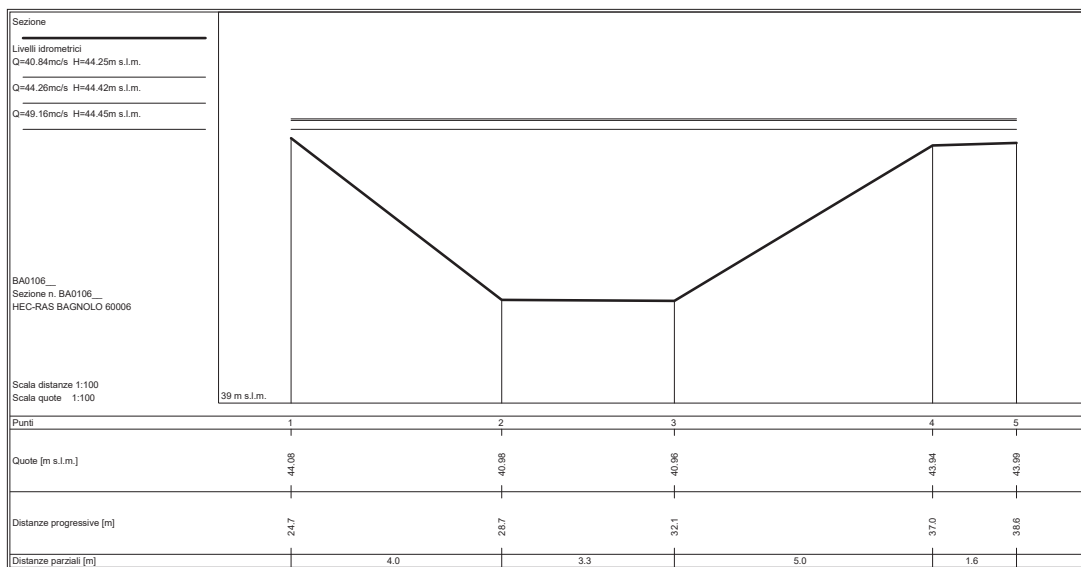
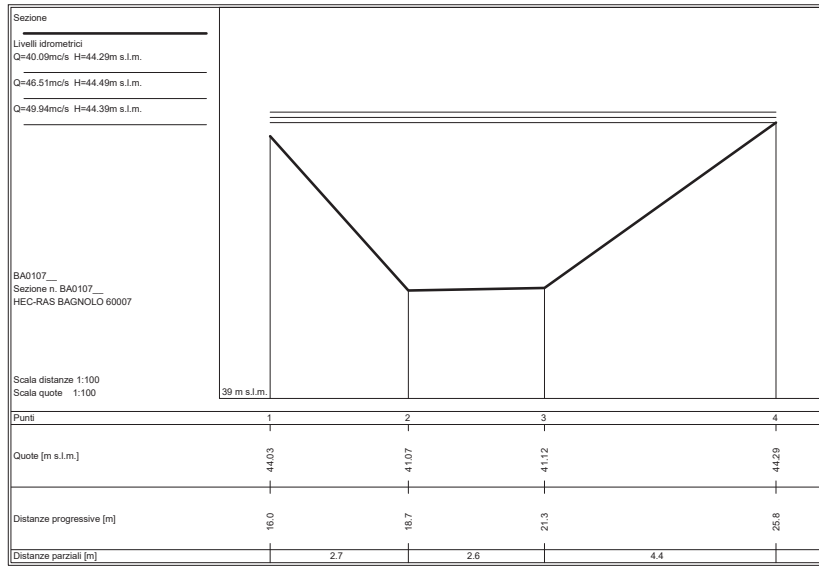

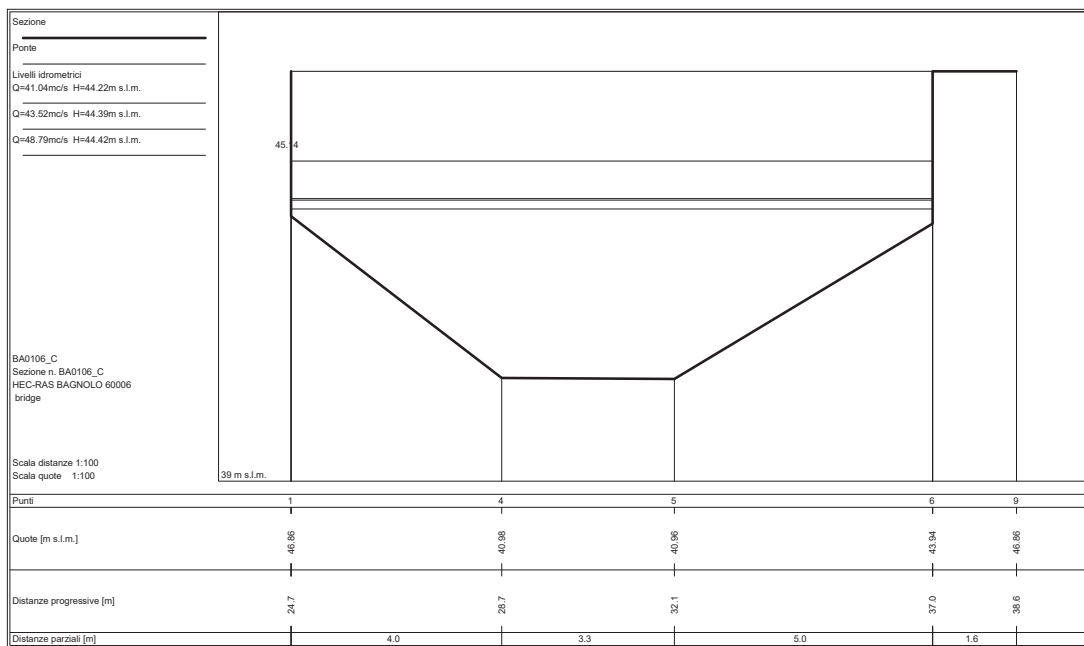
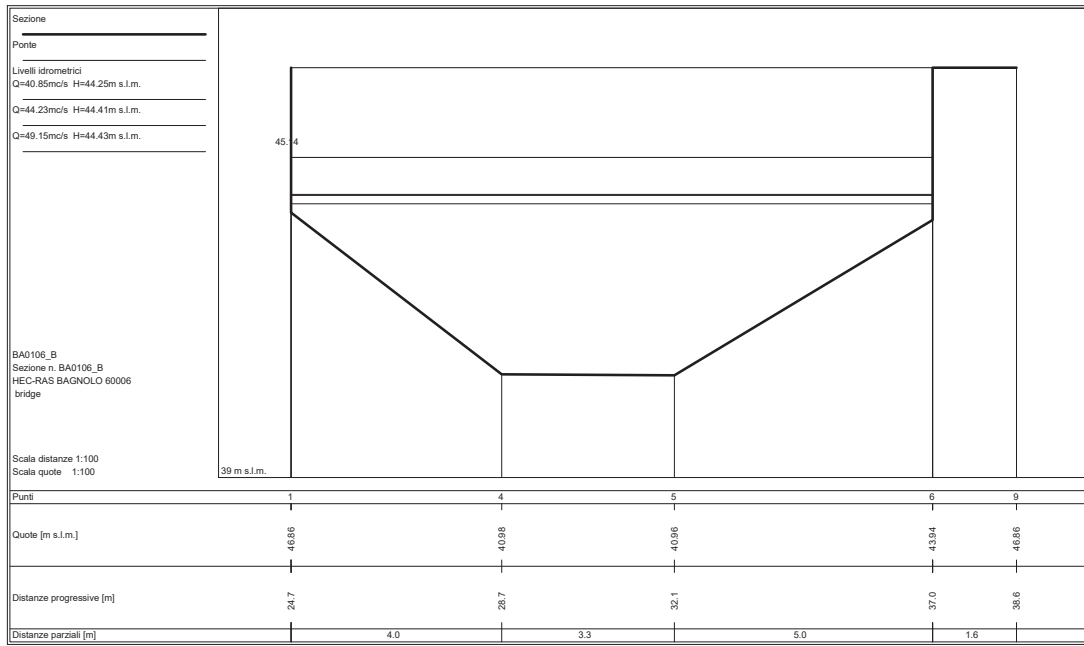

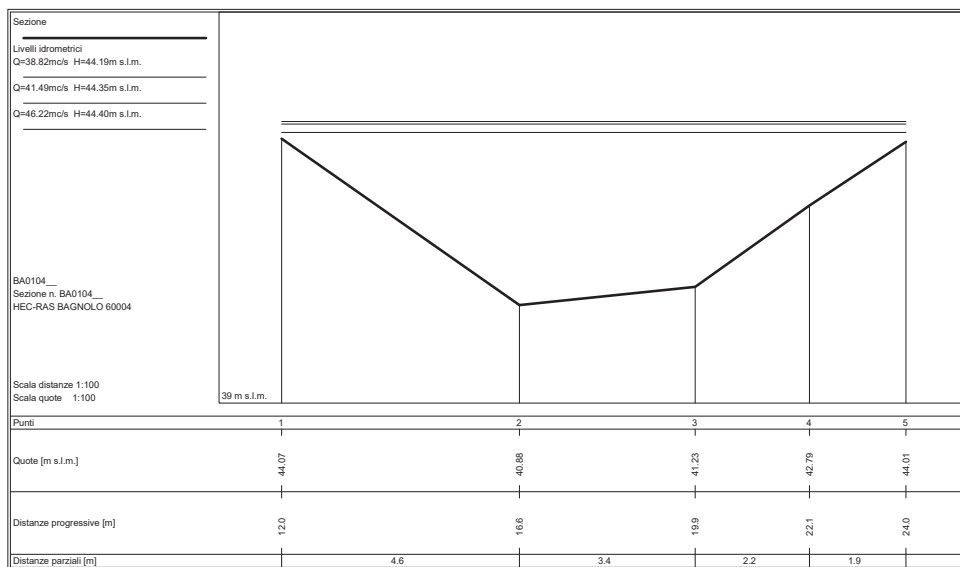
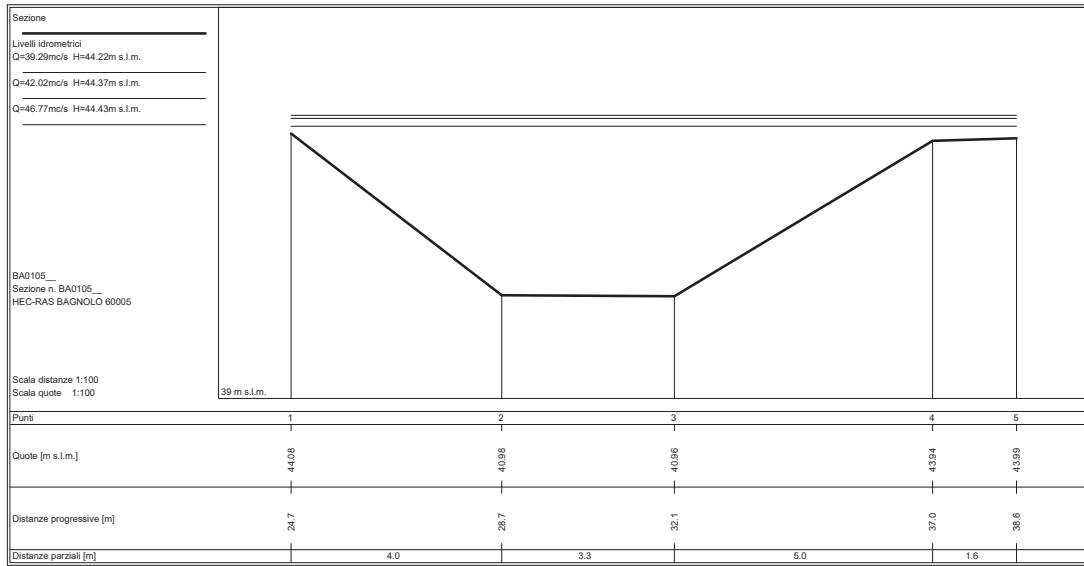

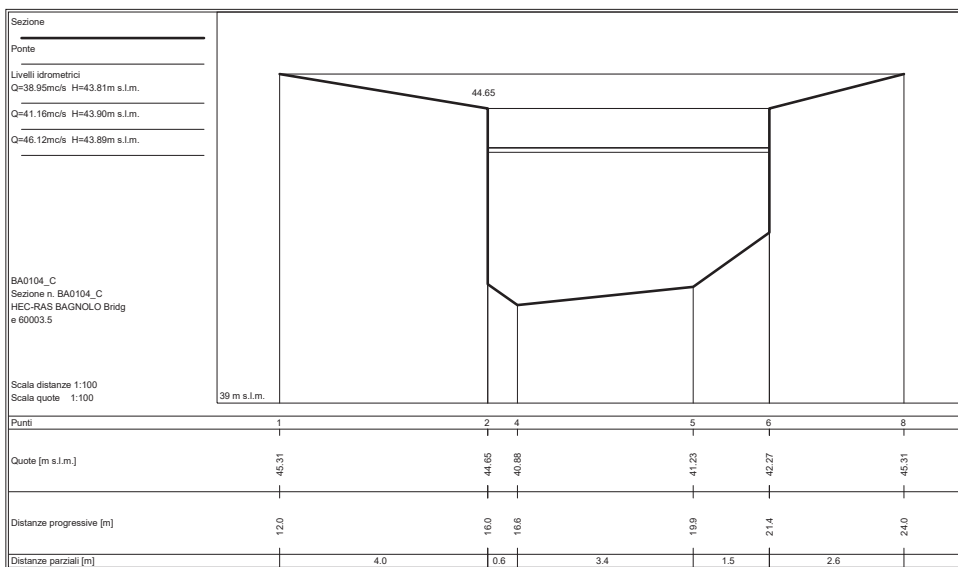
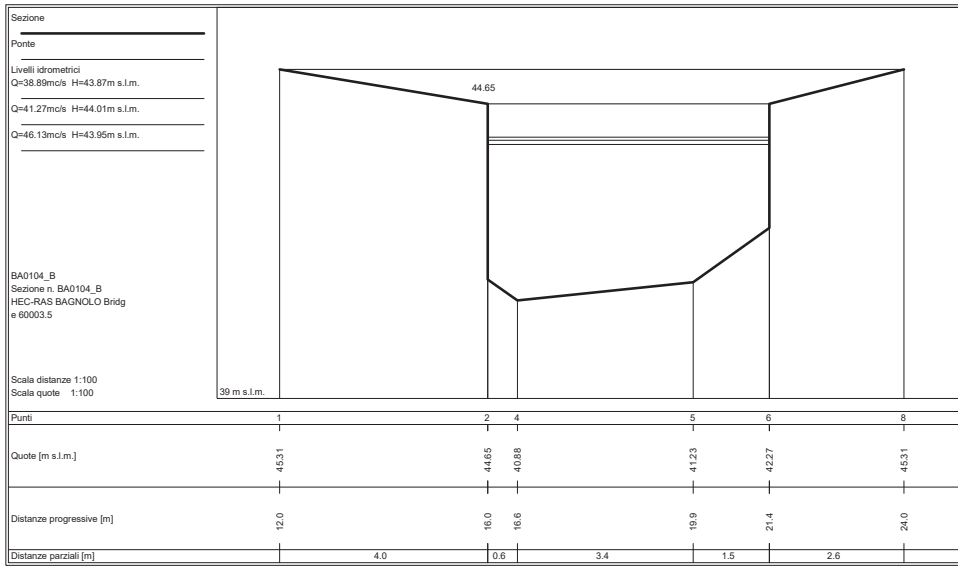

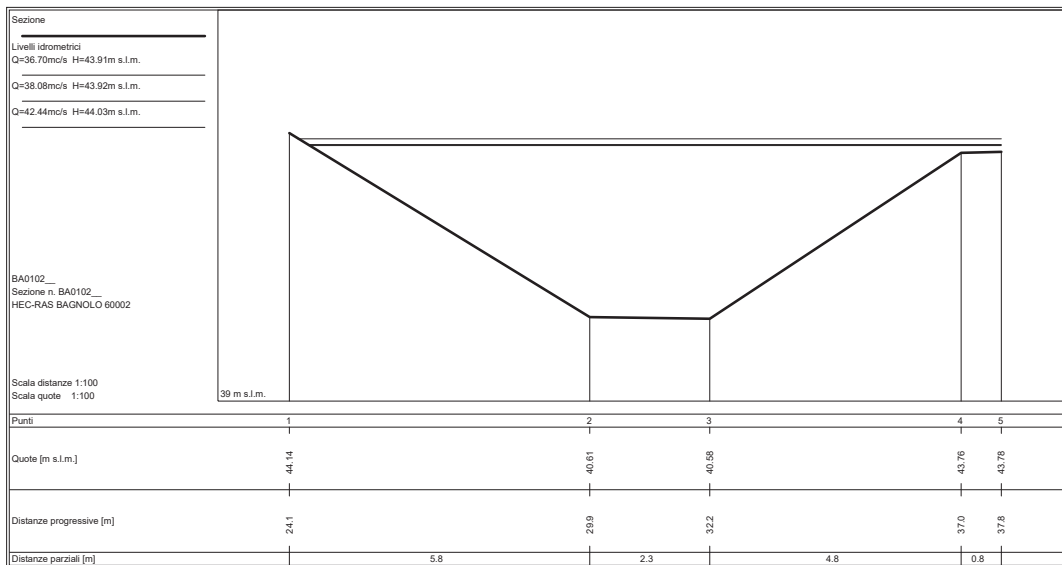
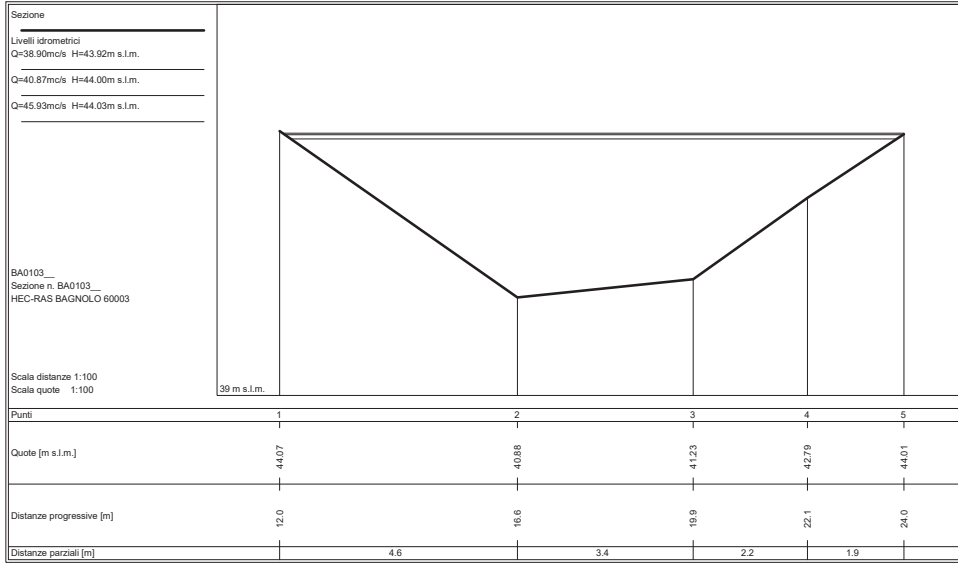



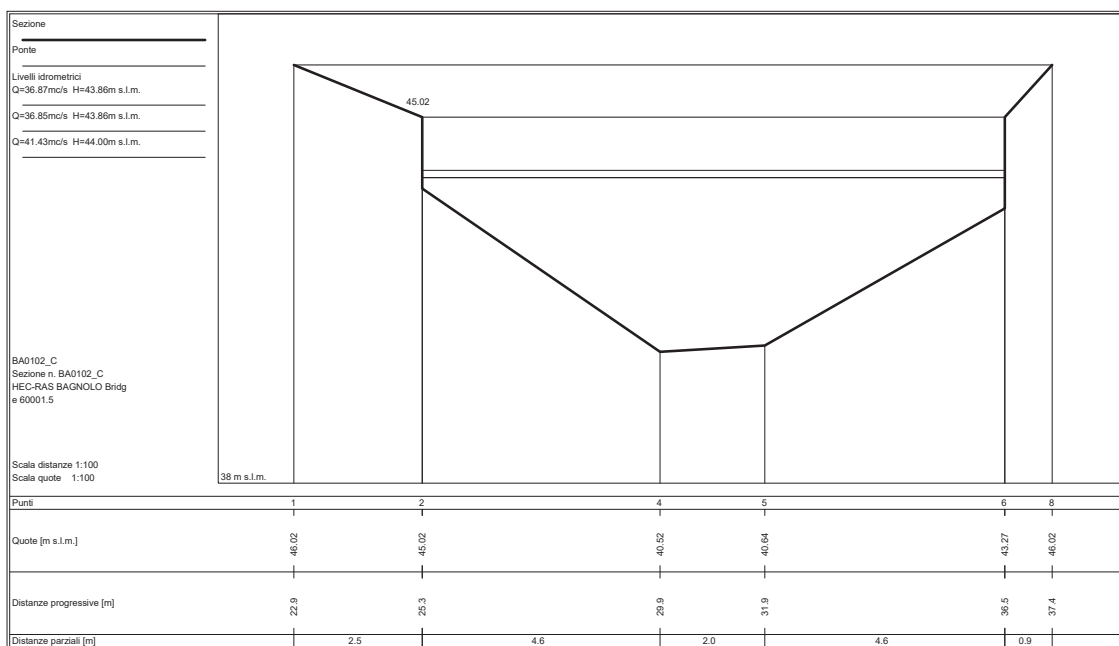
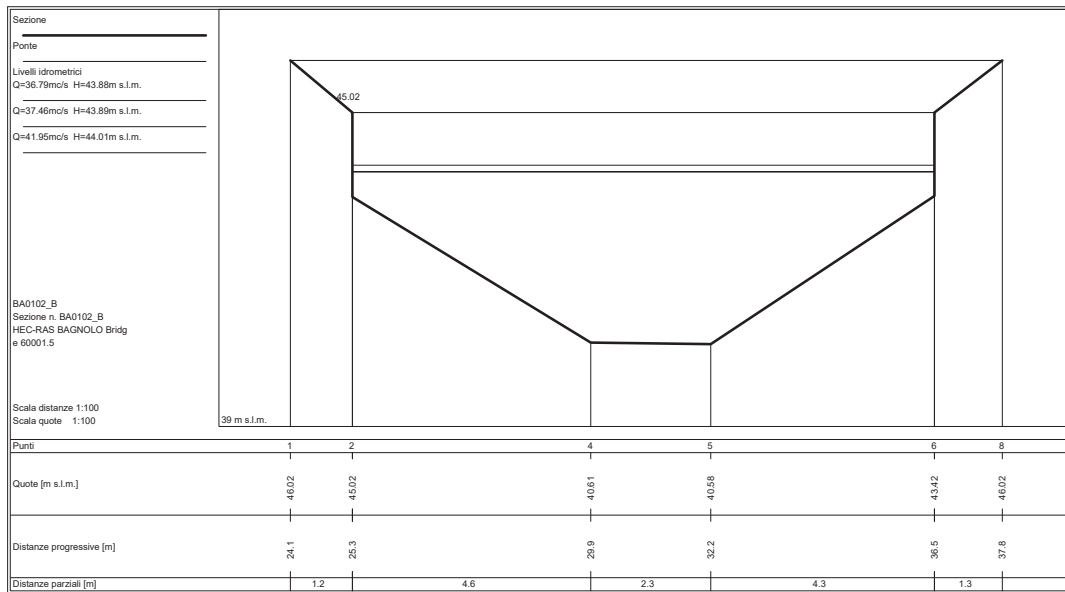

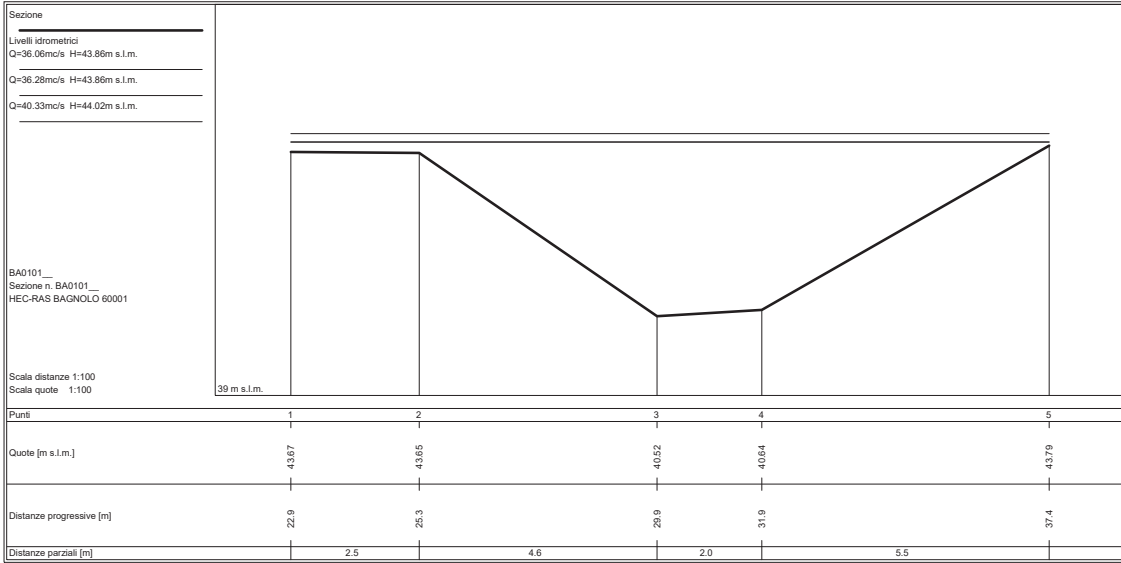

SEZIONI FLUVIALI  
TORRENTE BURE - TRATTO 1

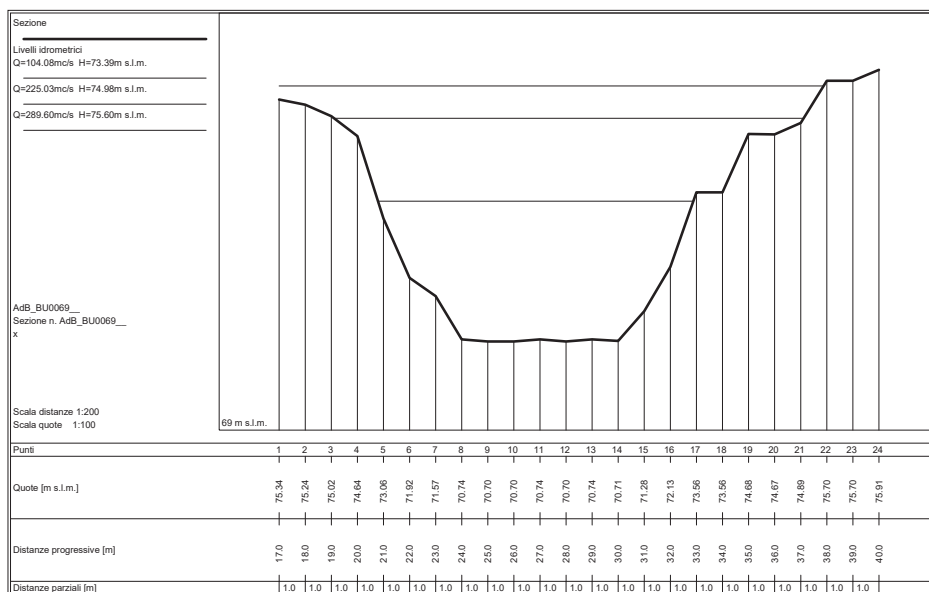
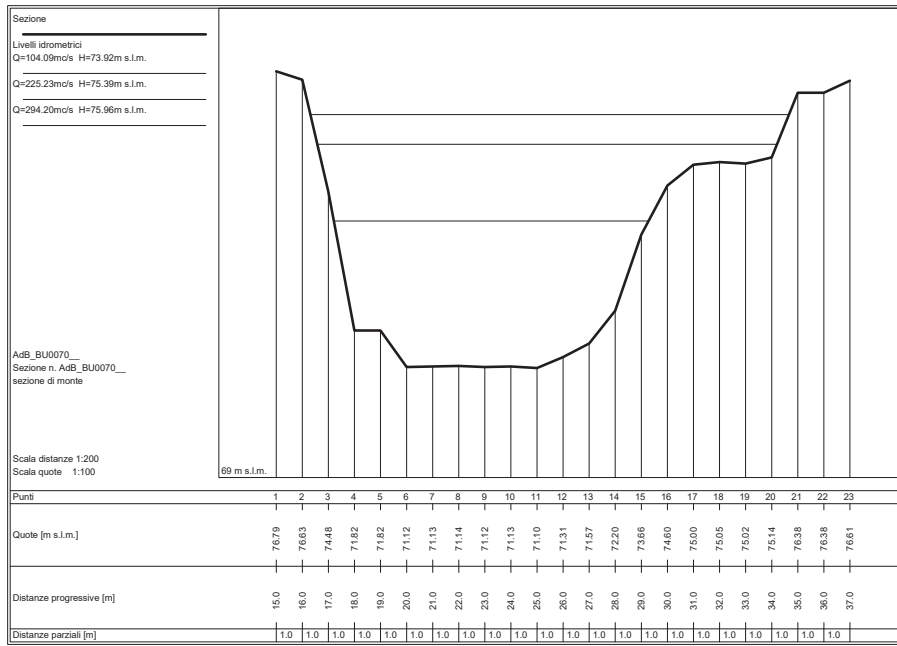







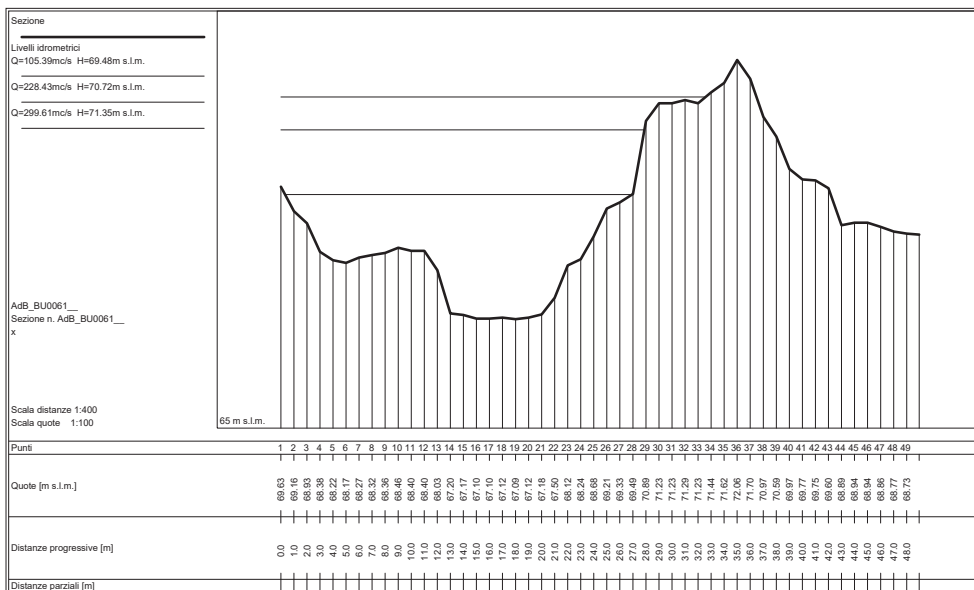
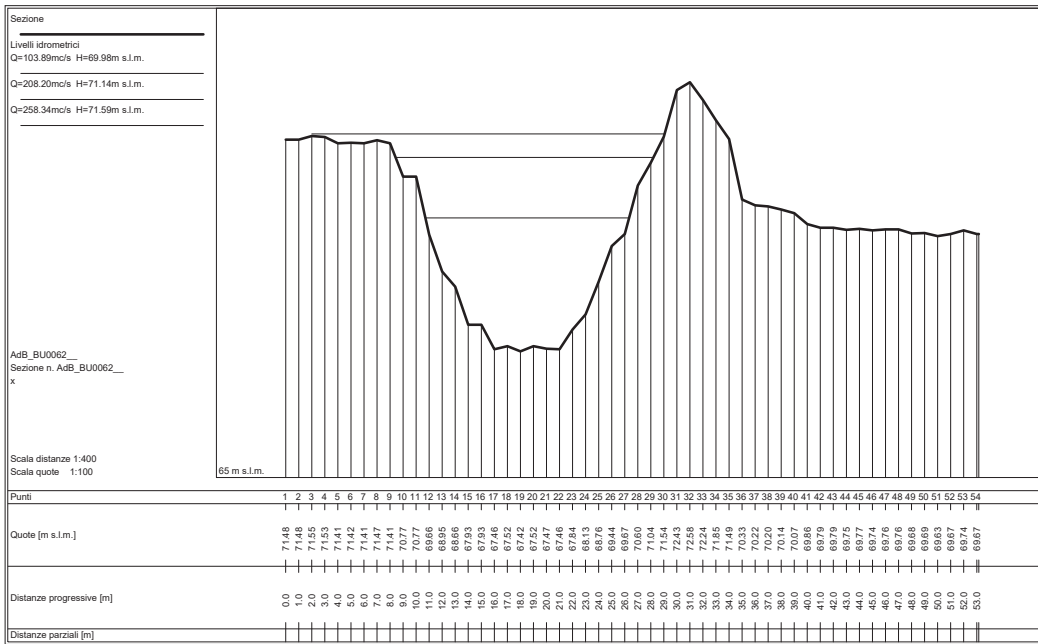











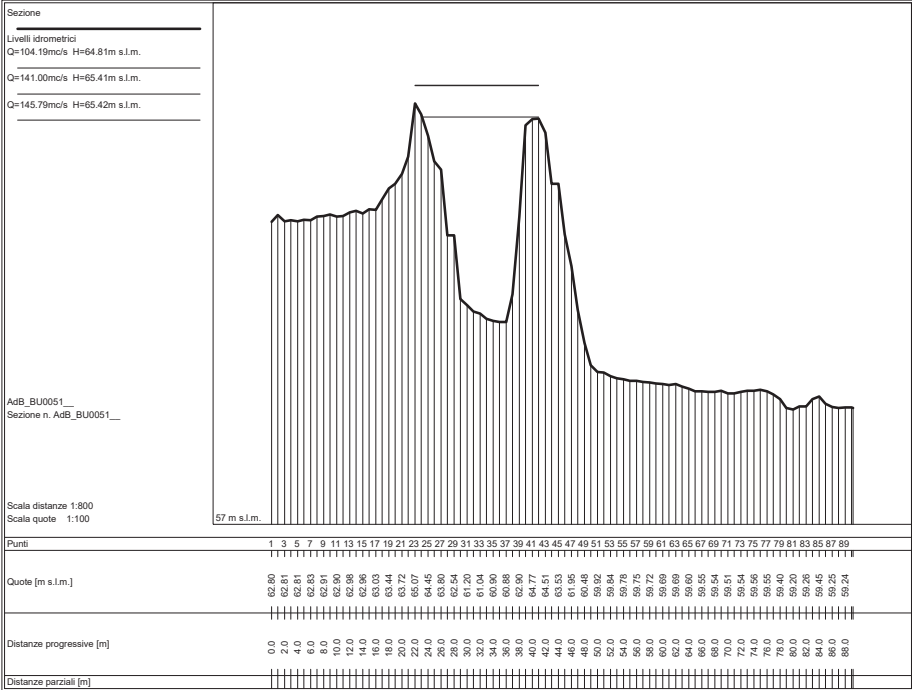
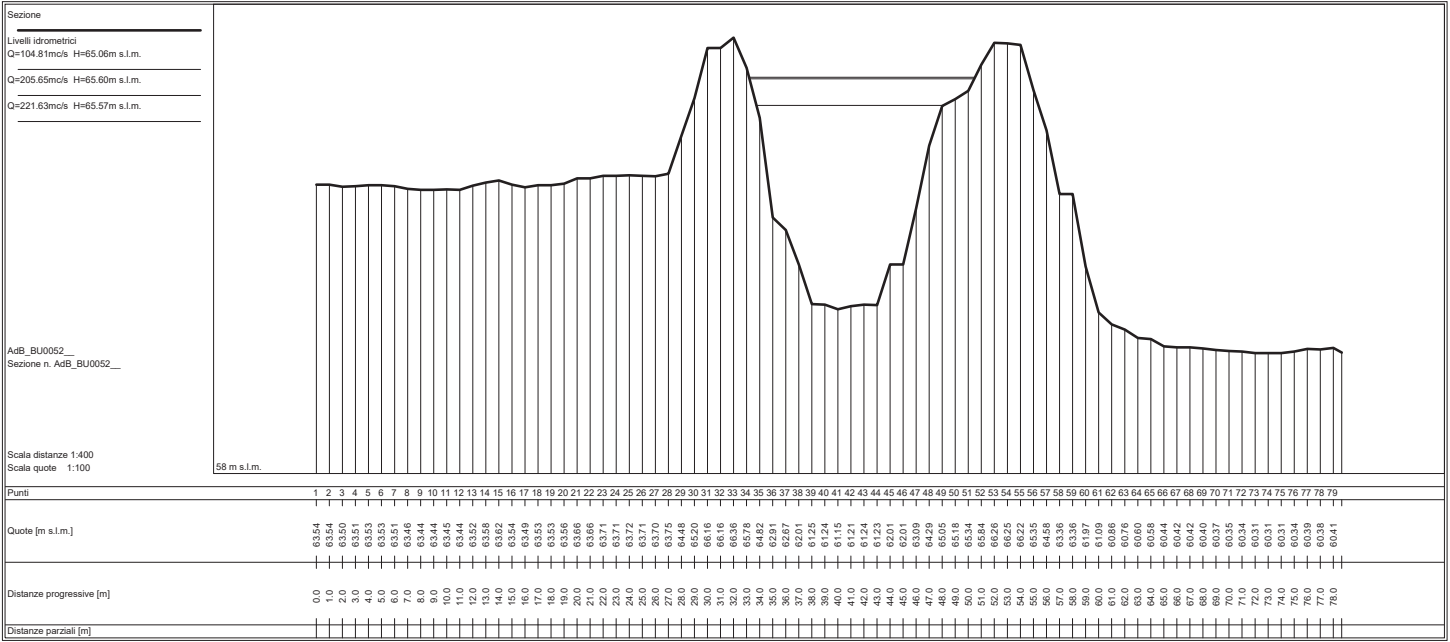



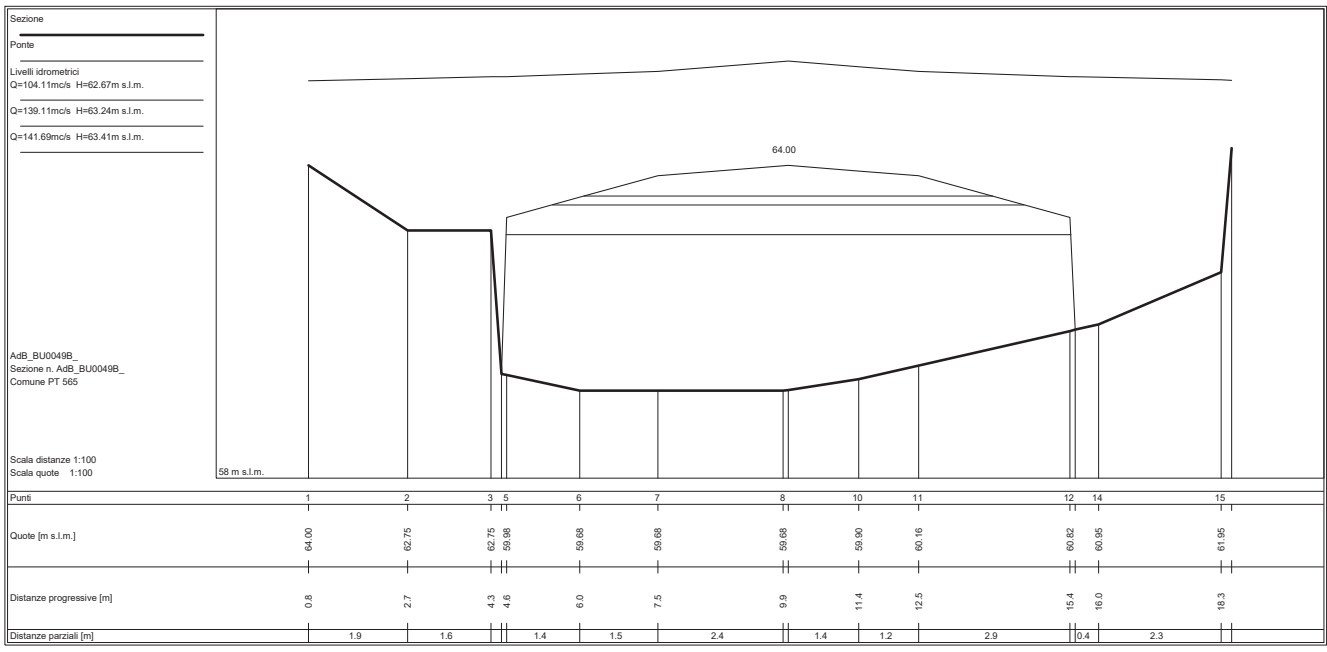
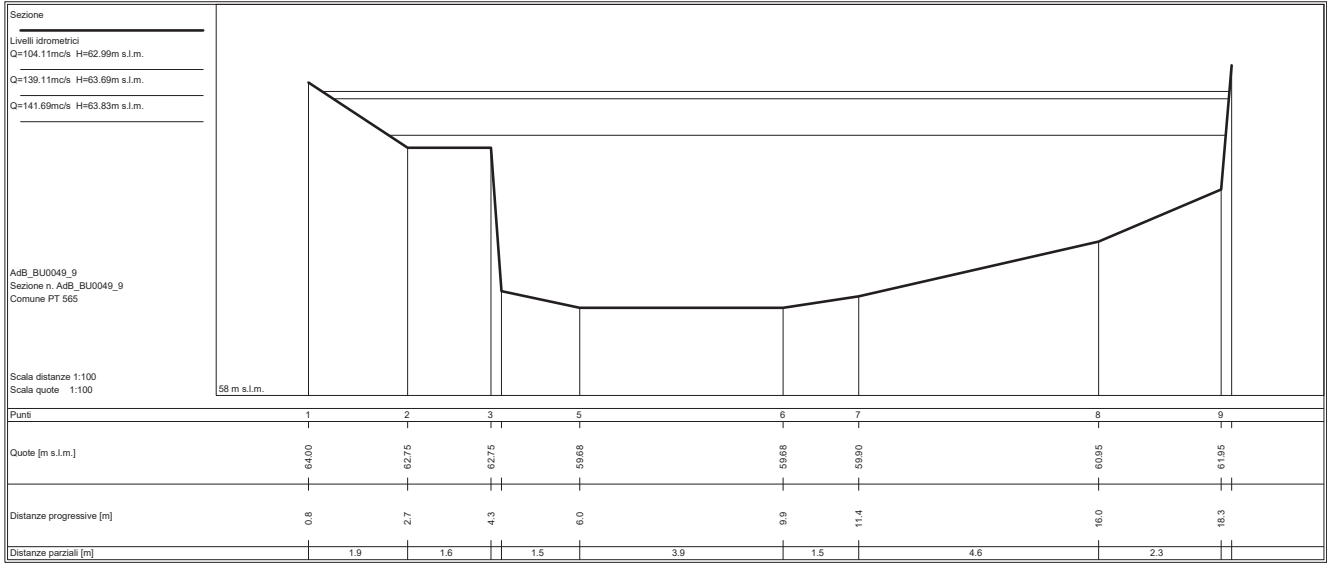

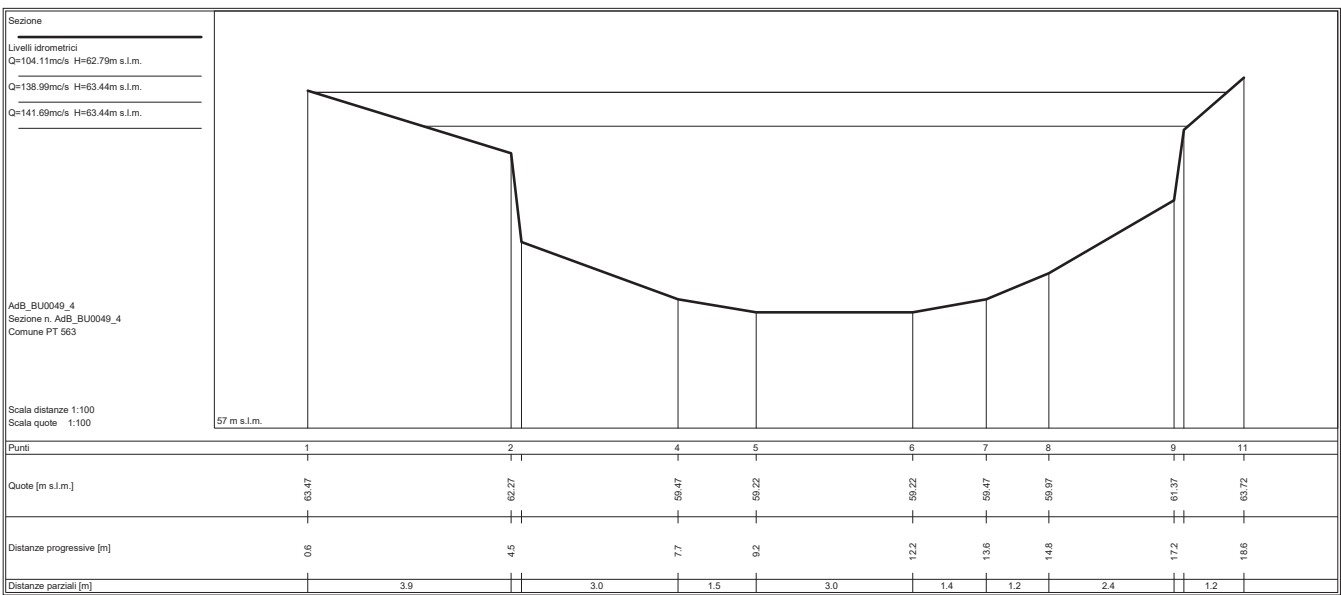
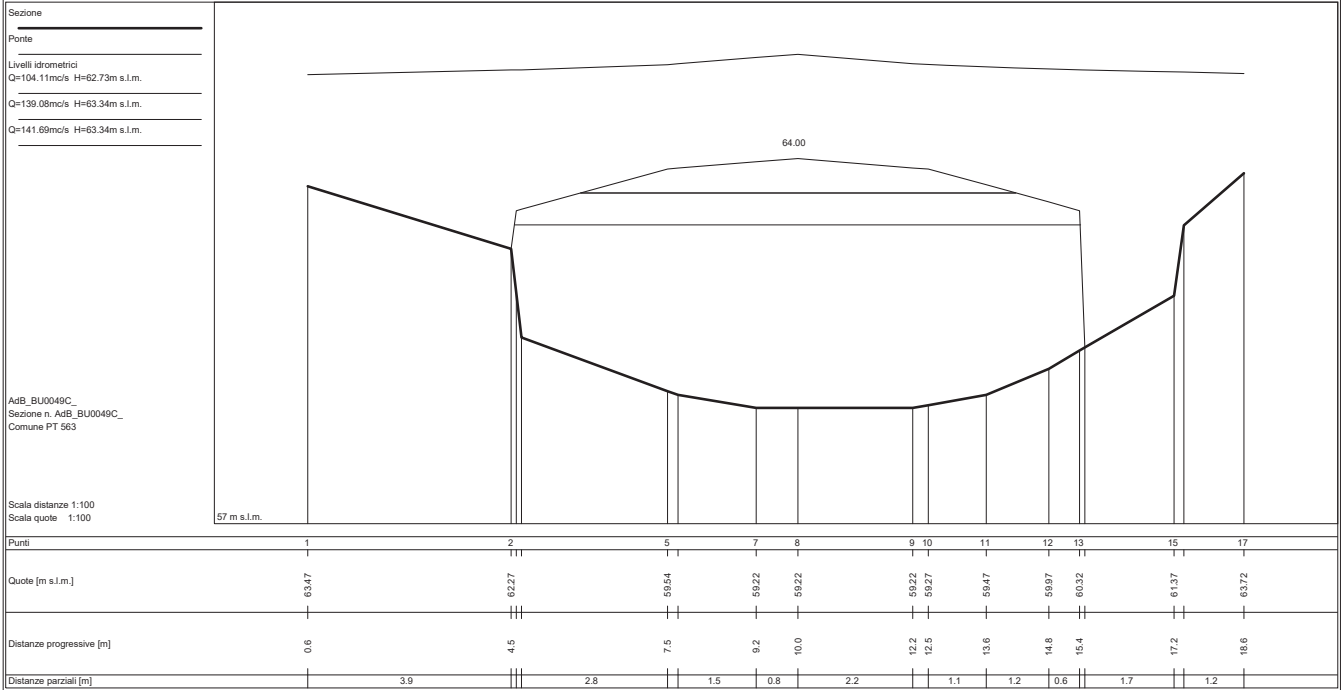







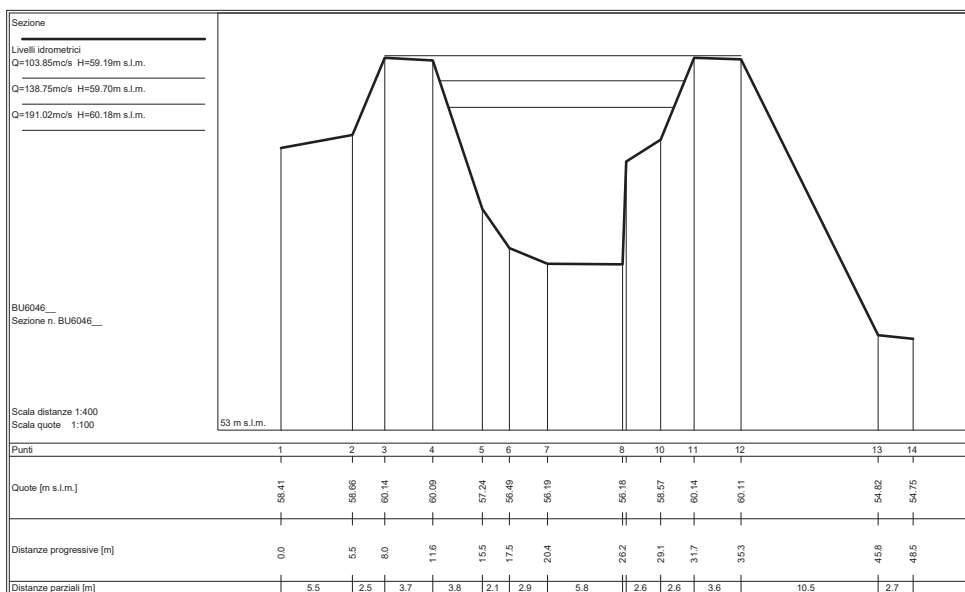
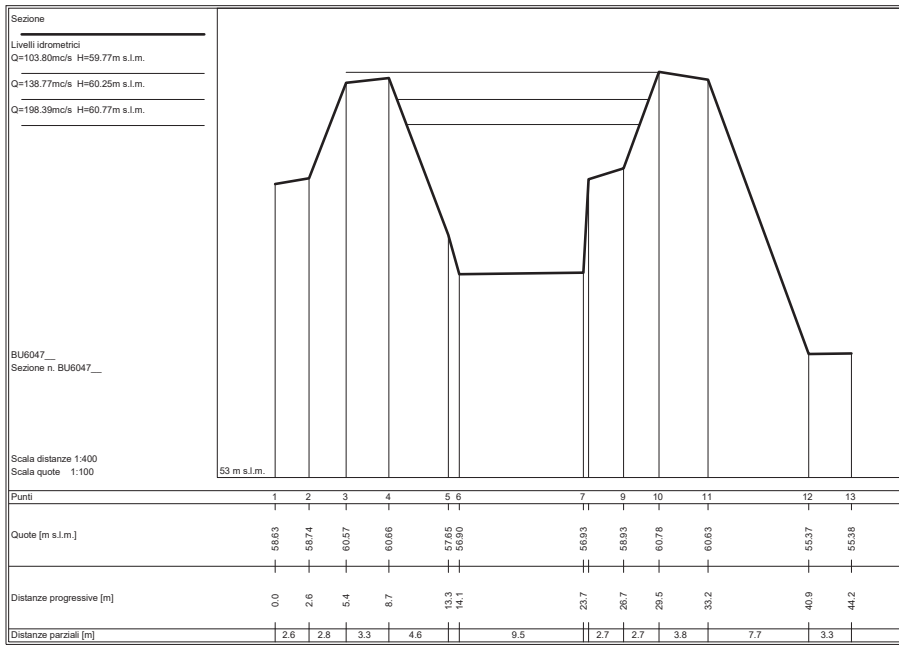

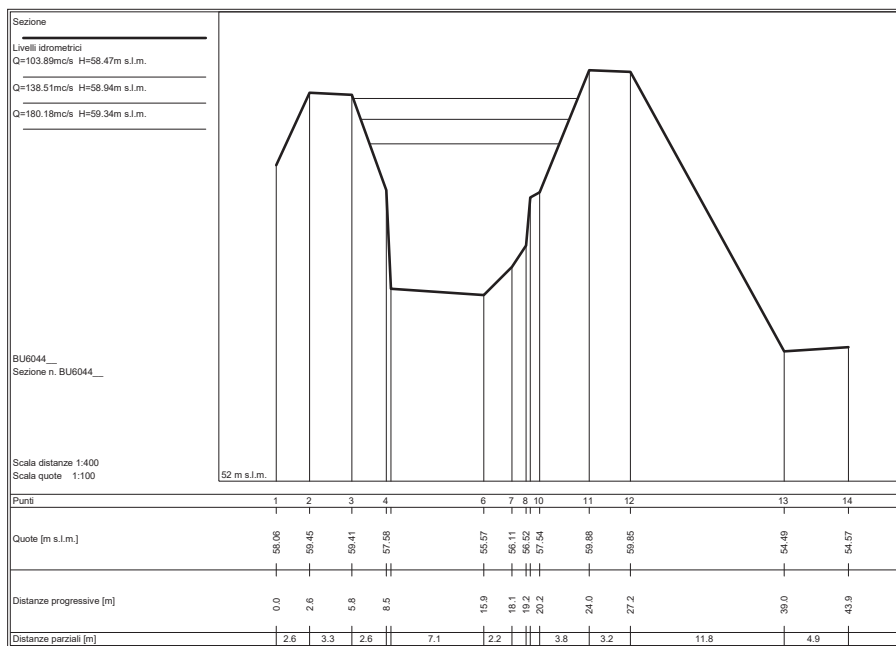
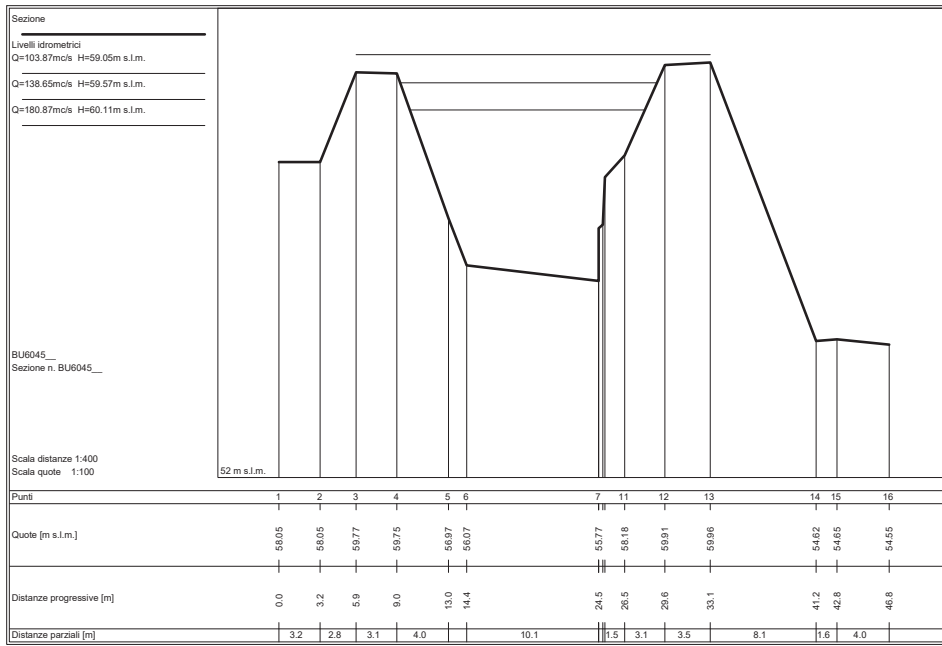

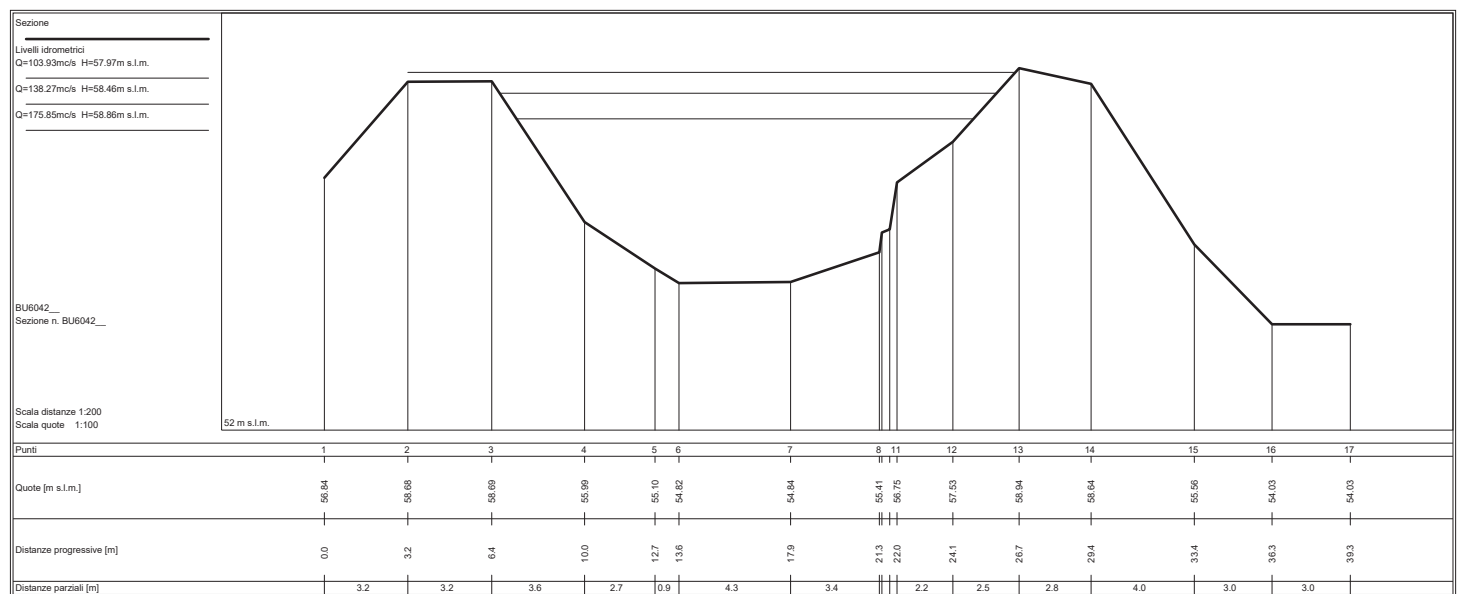
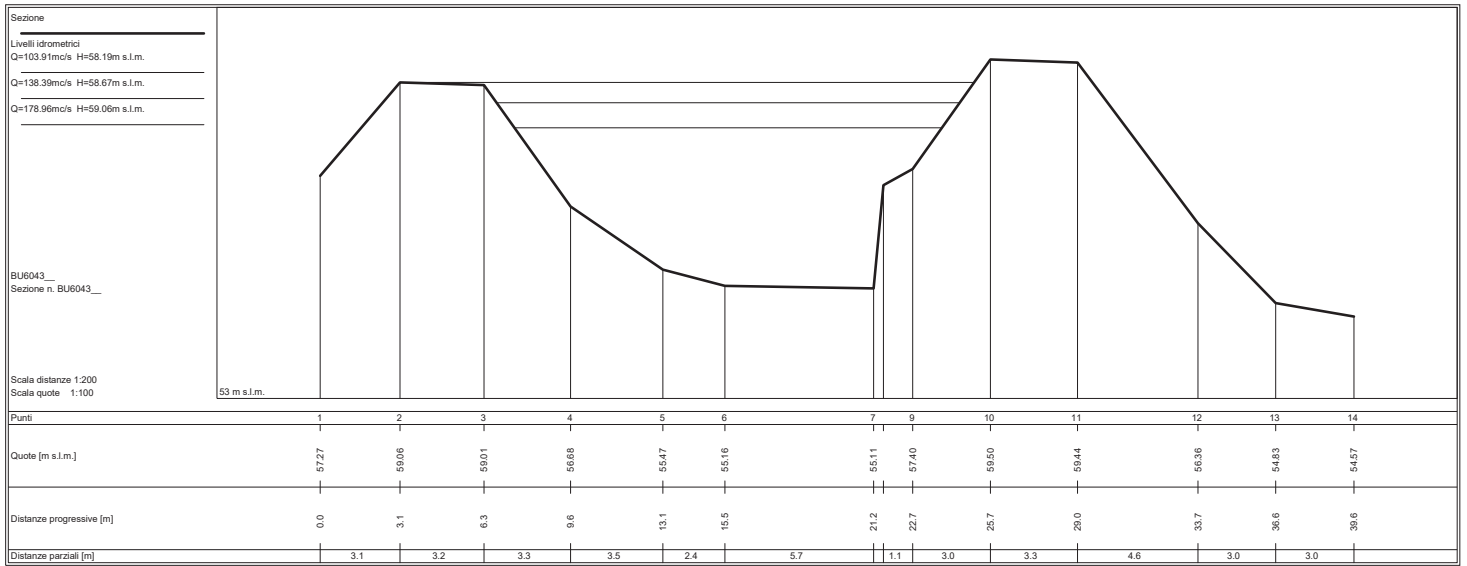

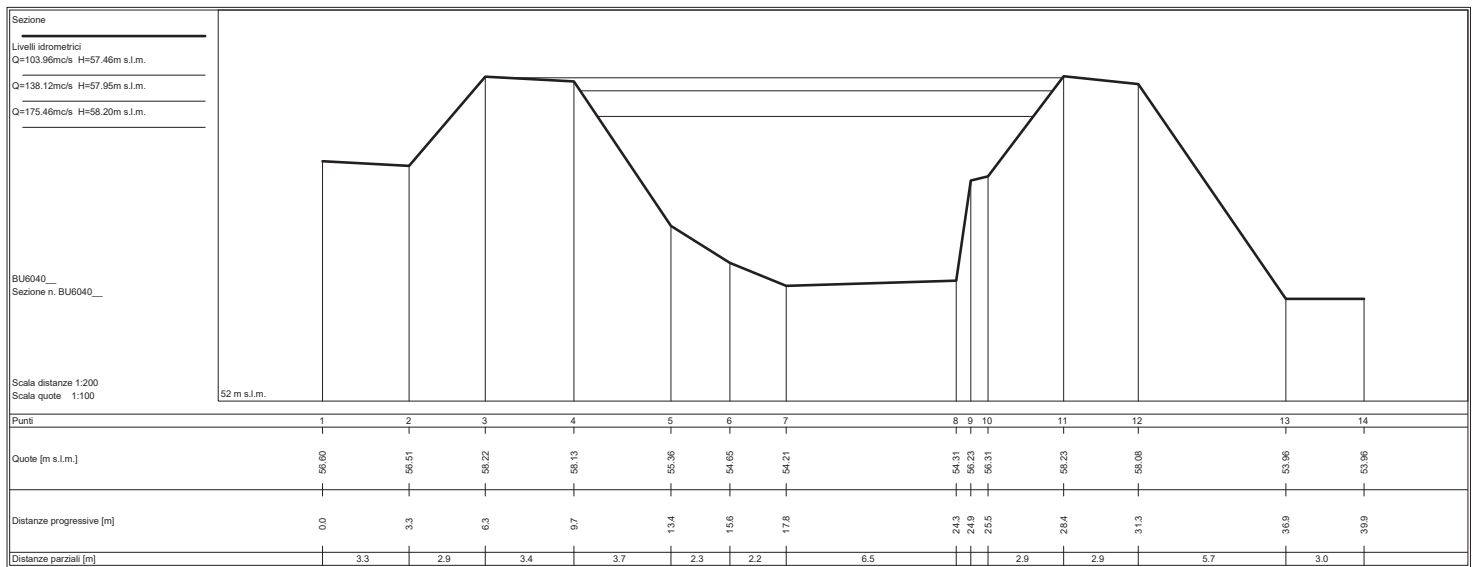
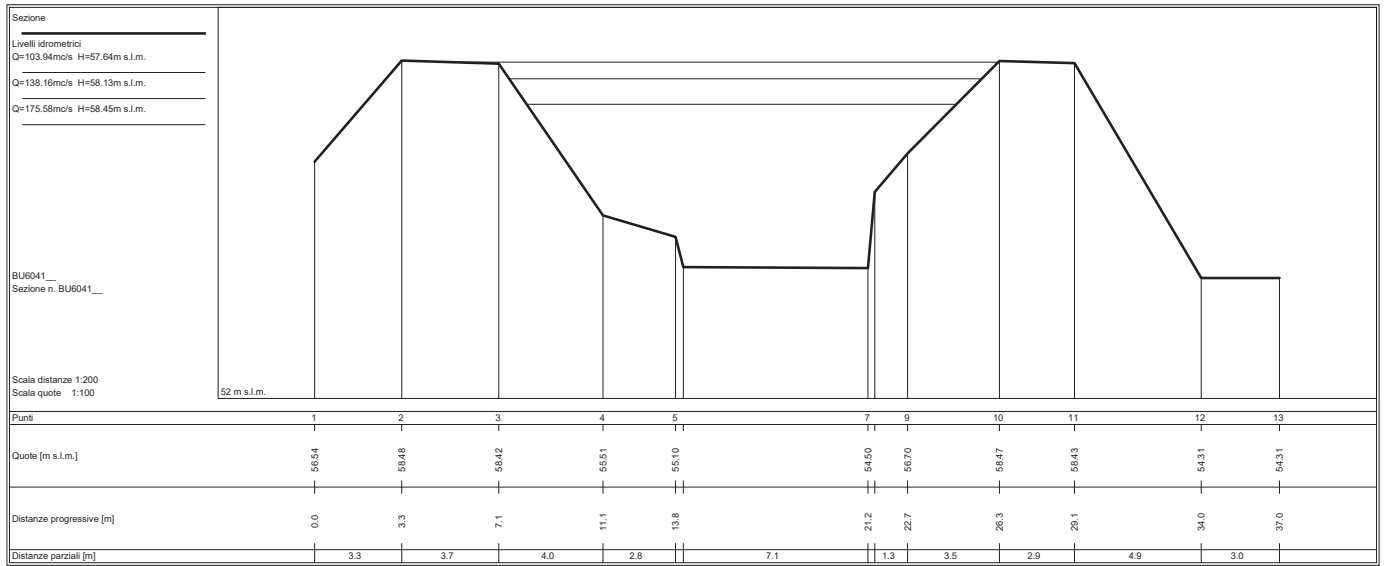

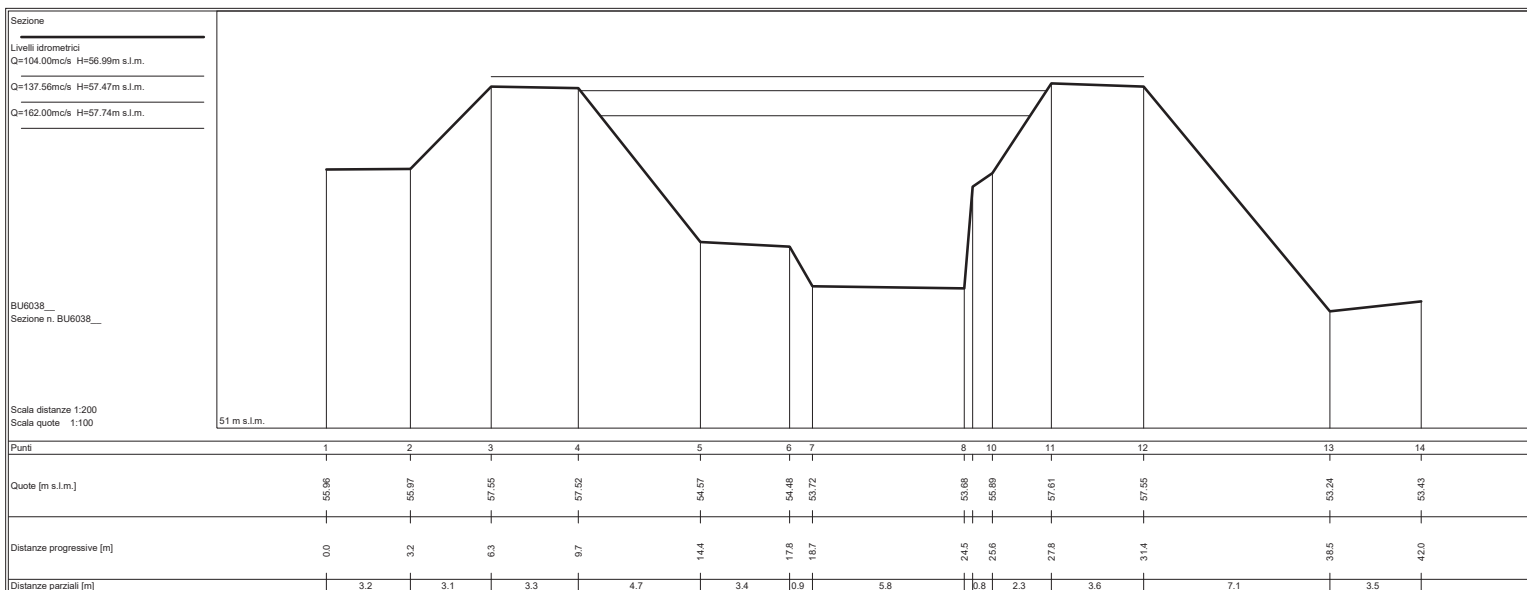
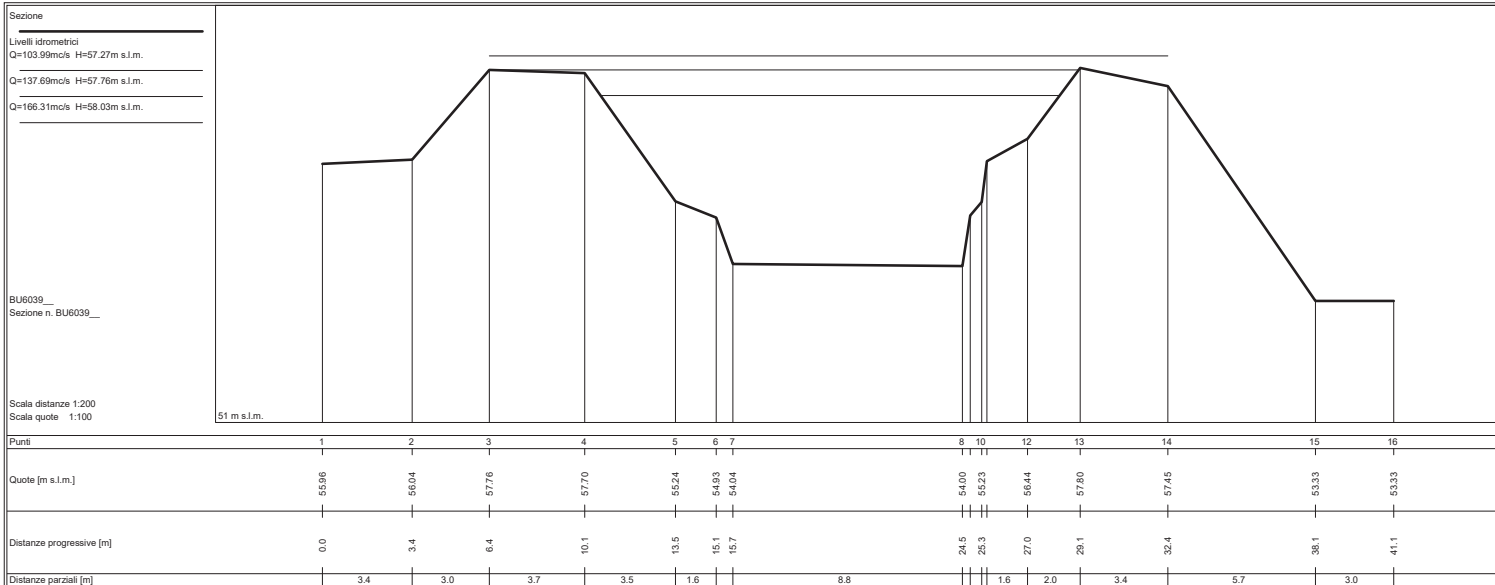

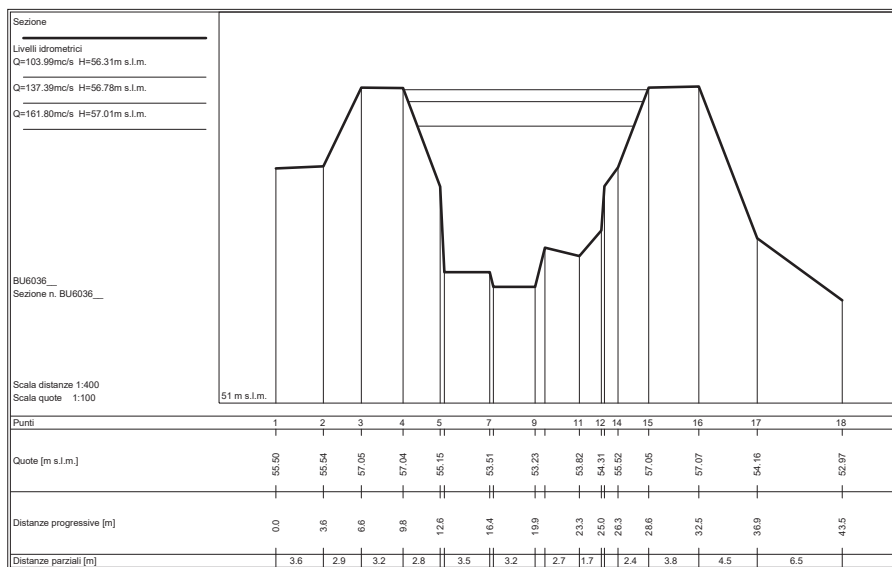
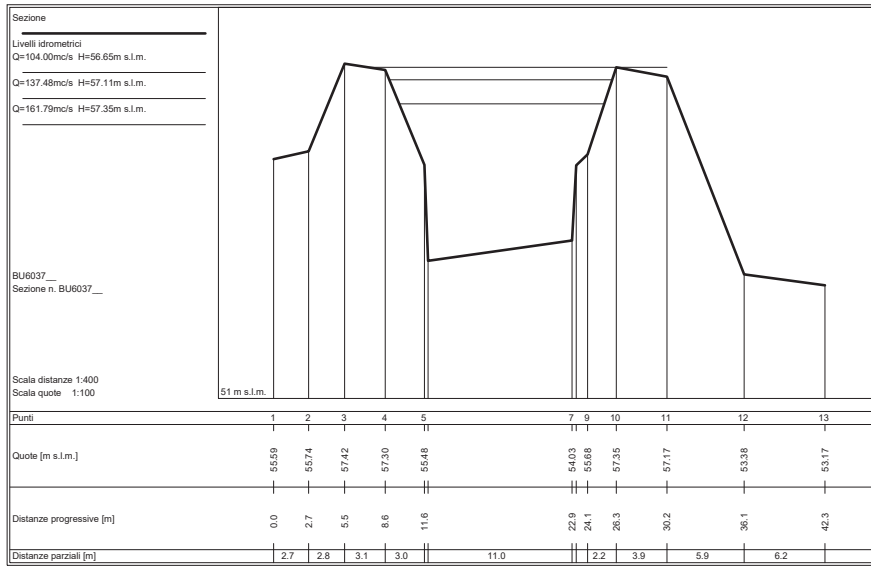



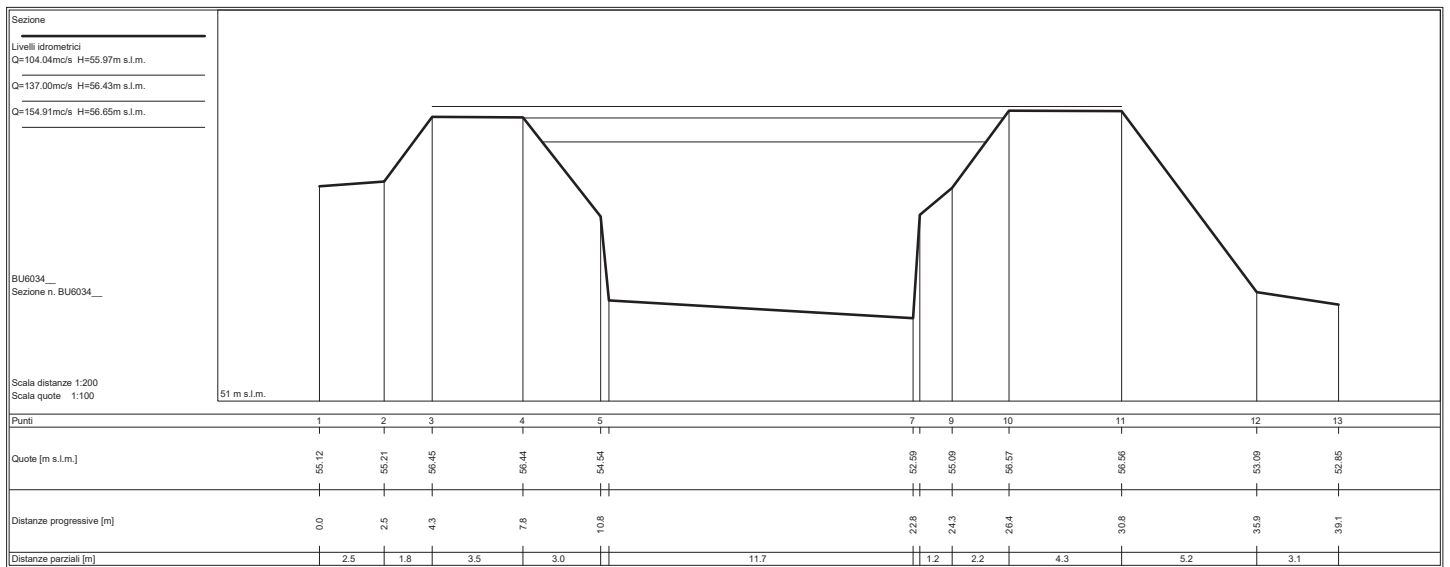
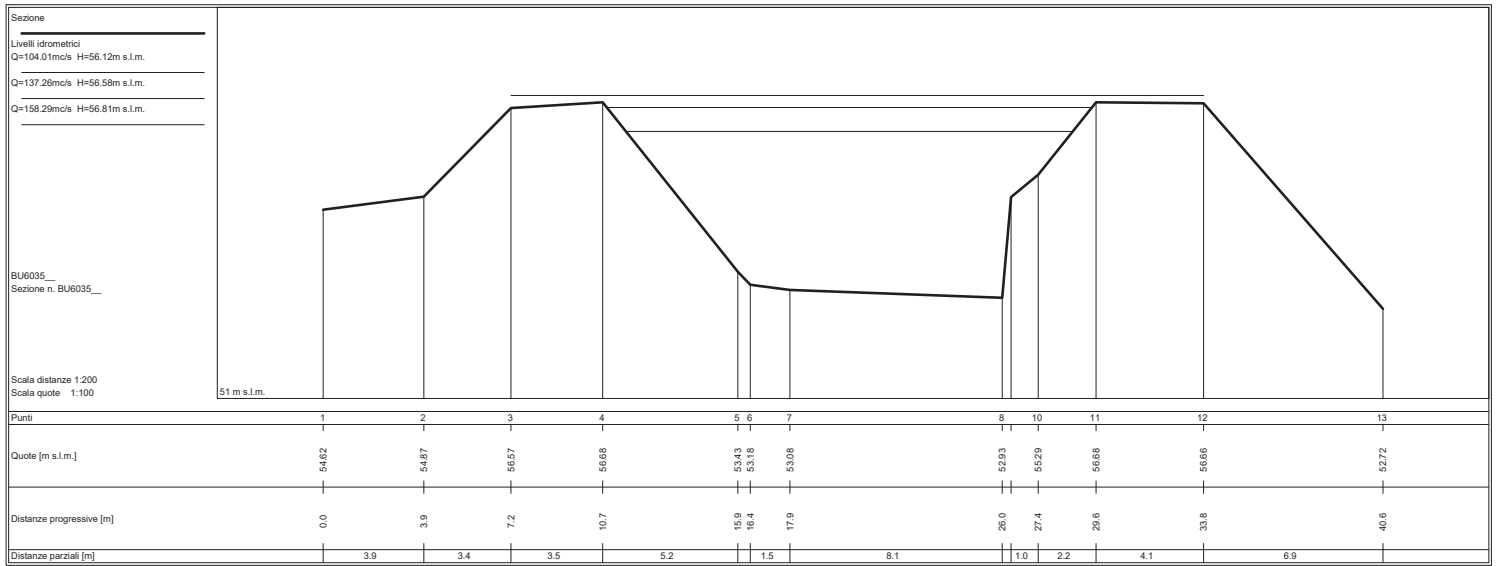

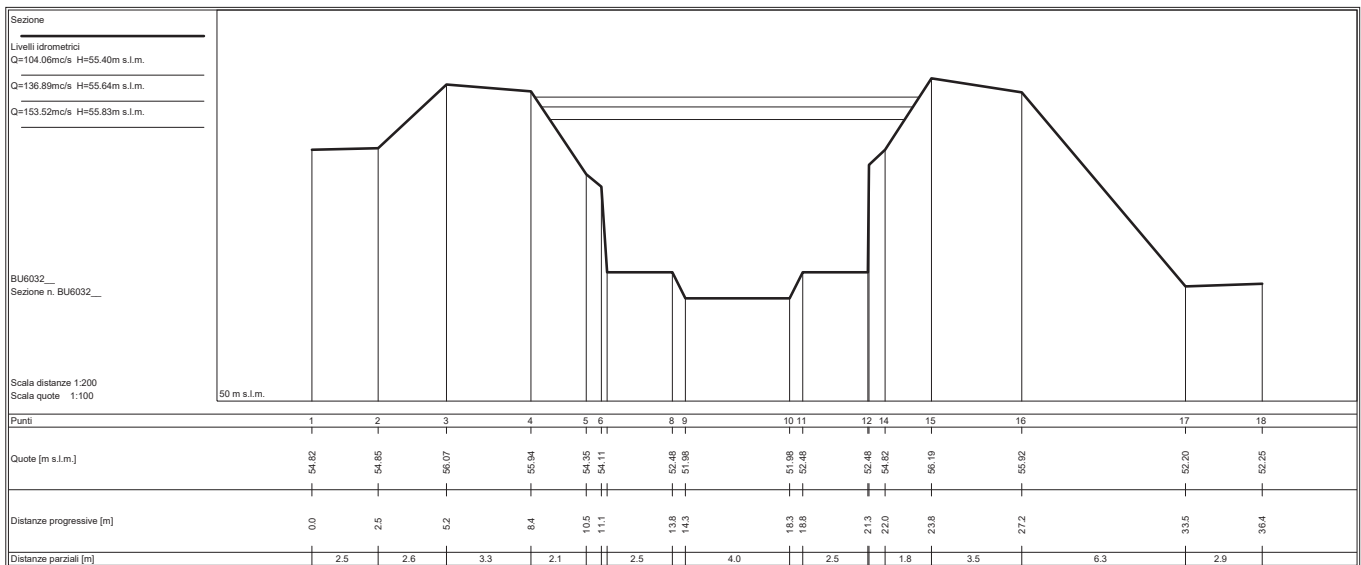
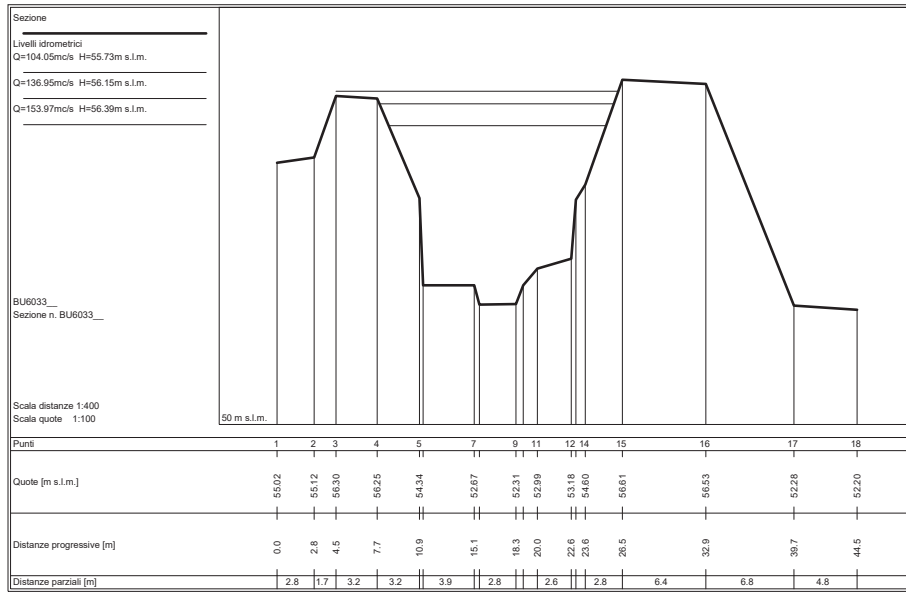

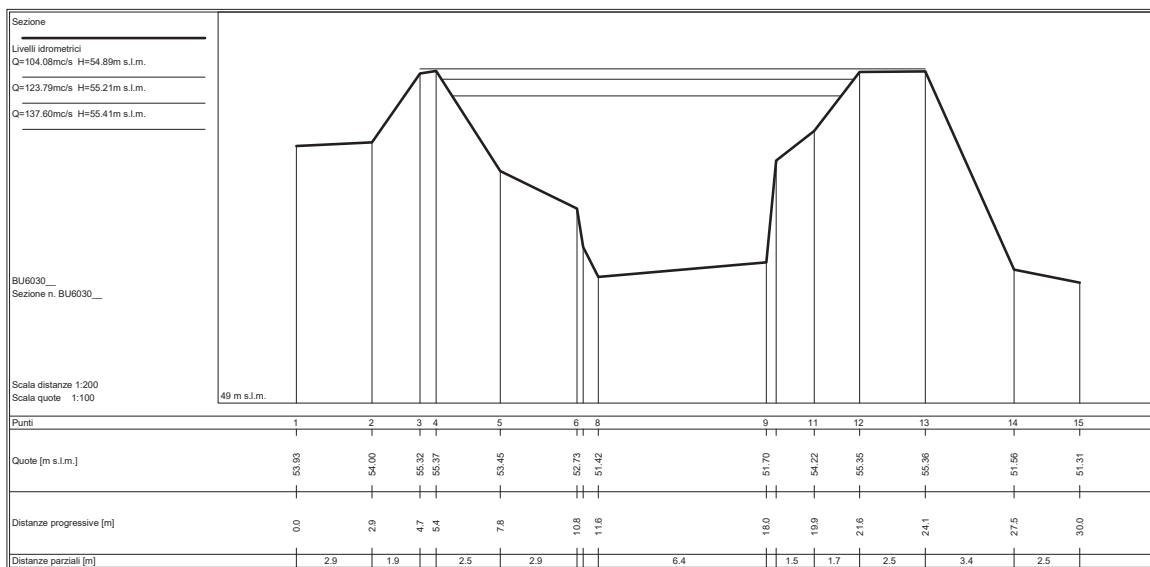
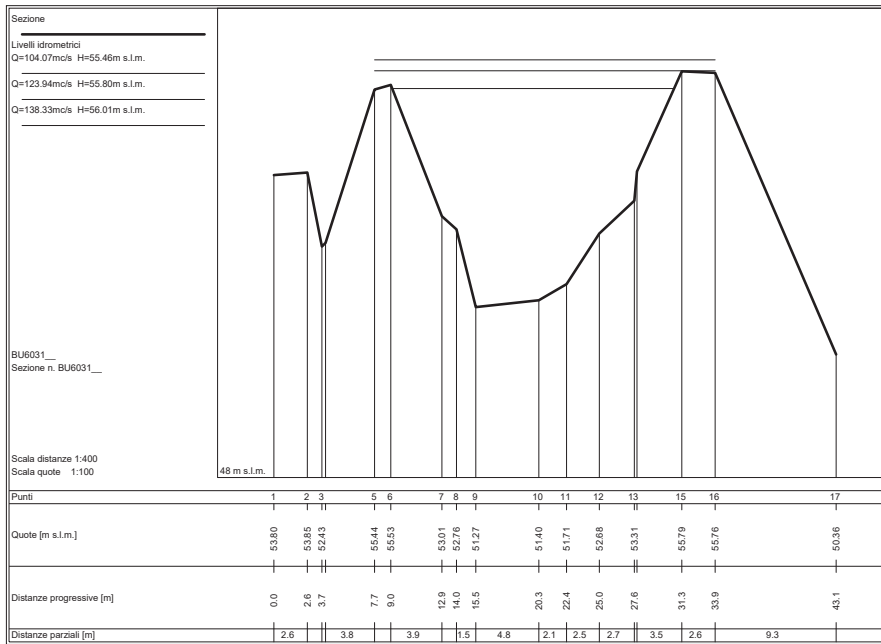

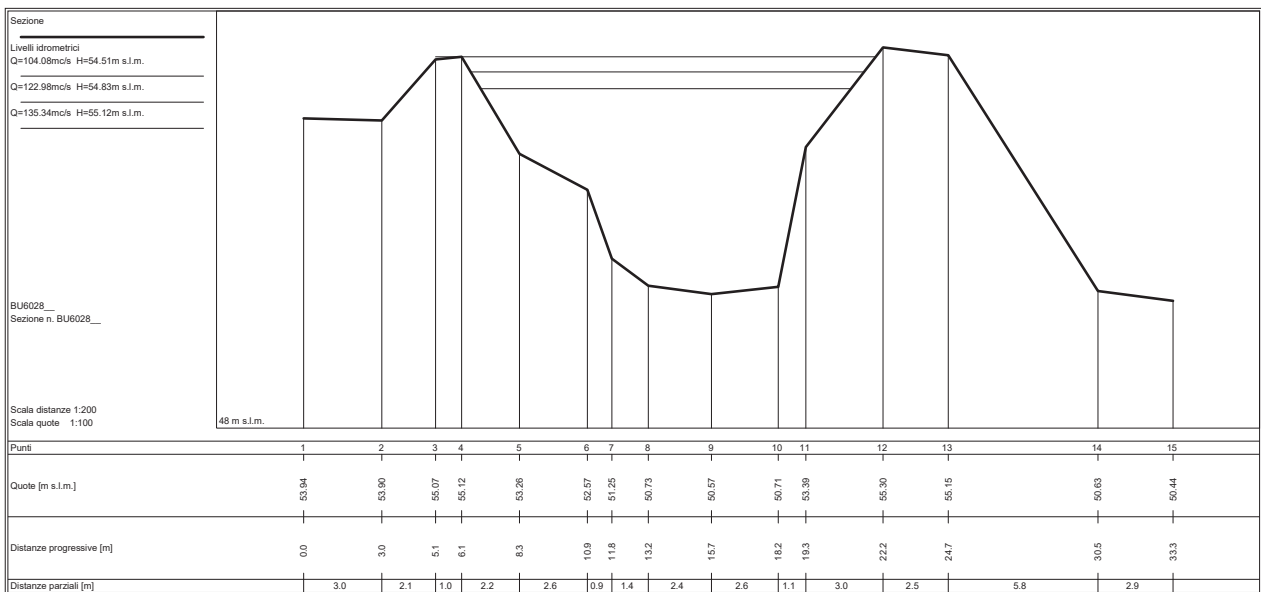
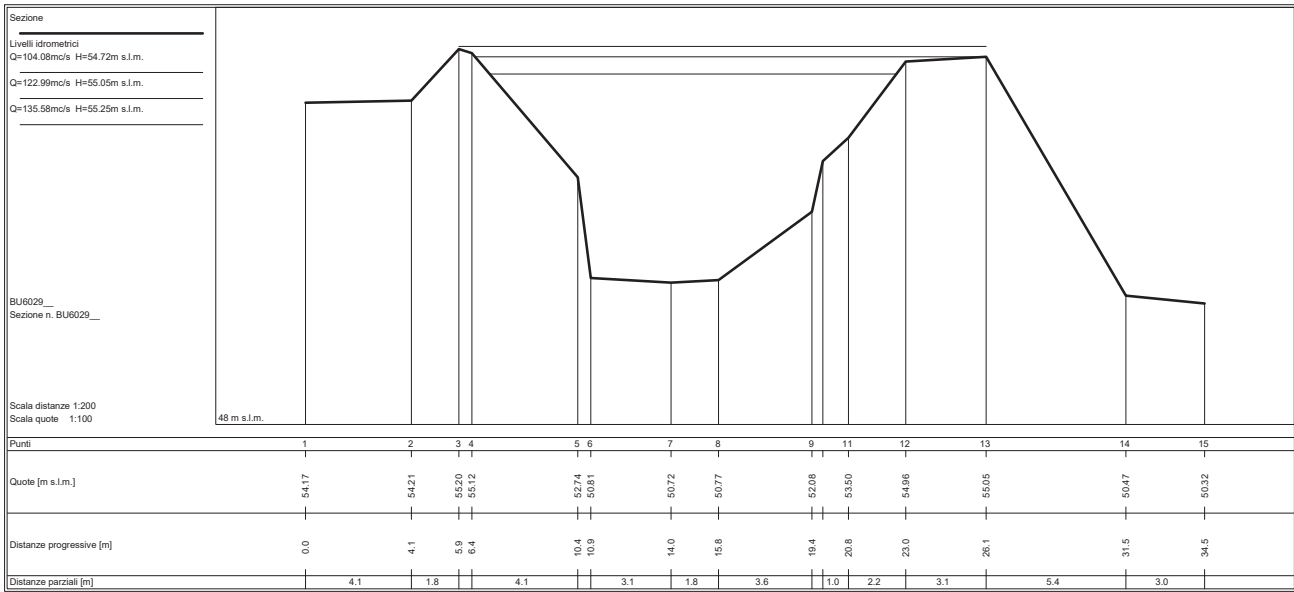

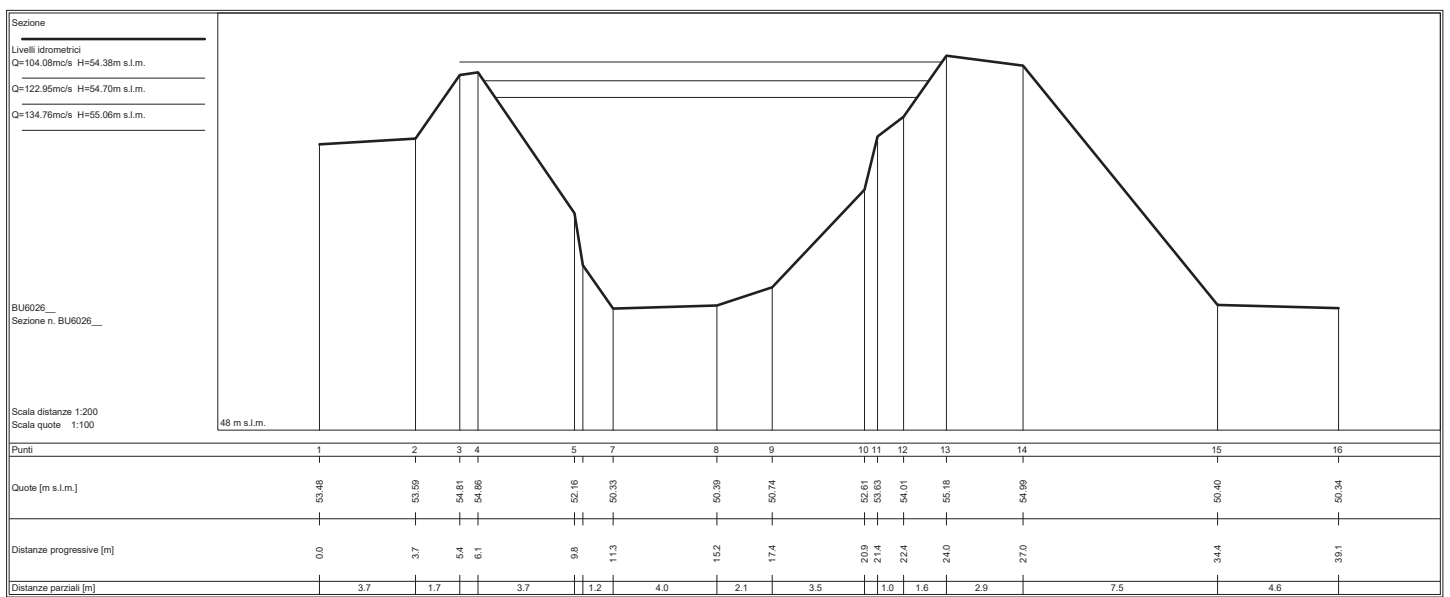
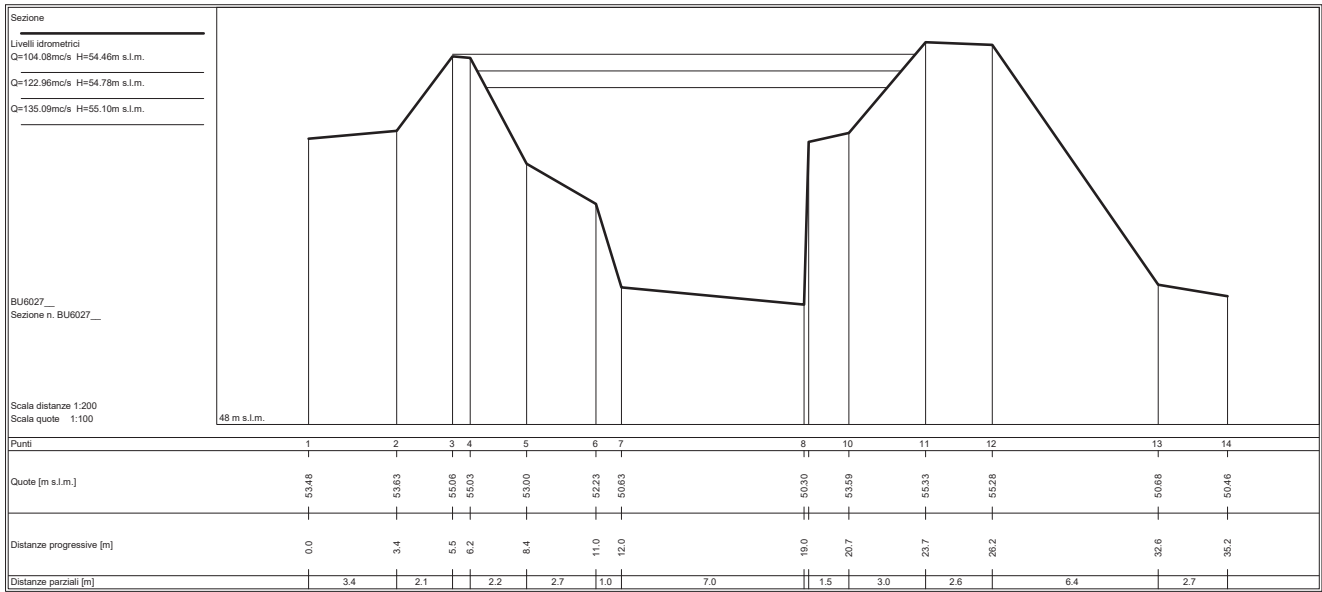

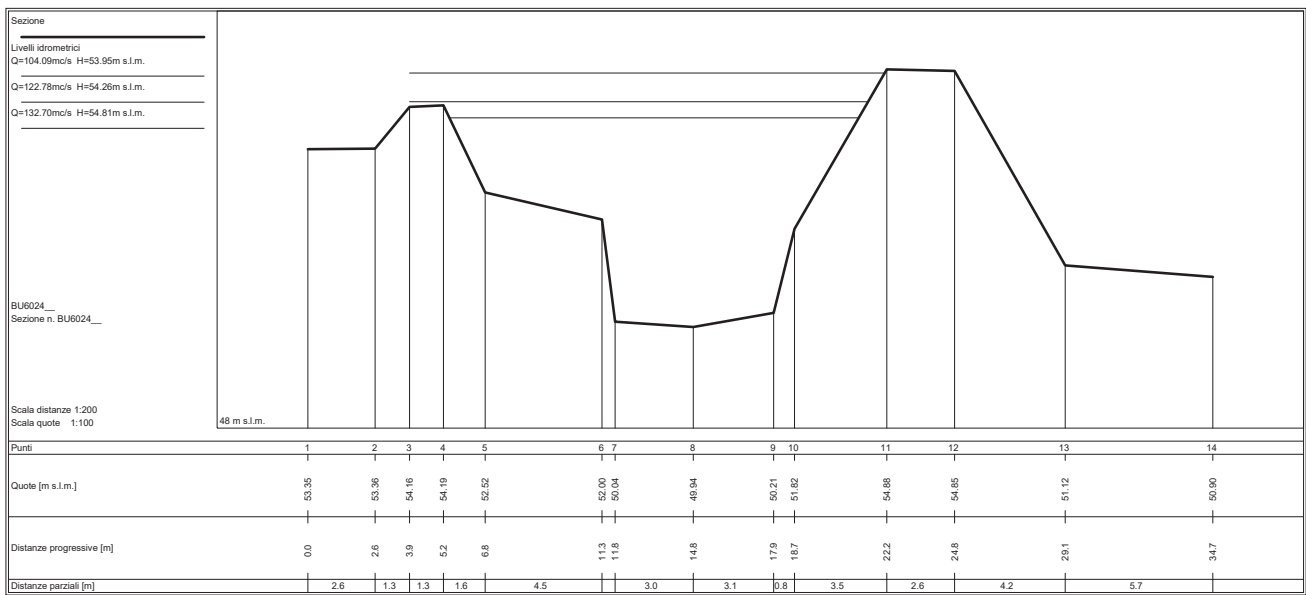
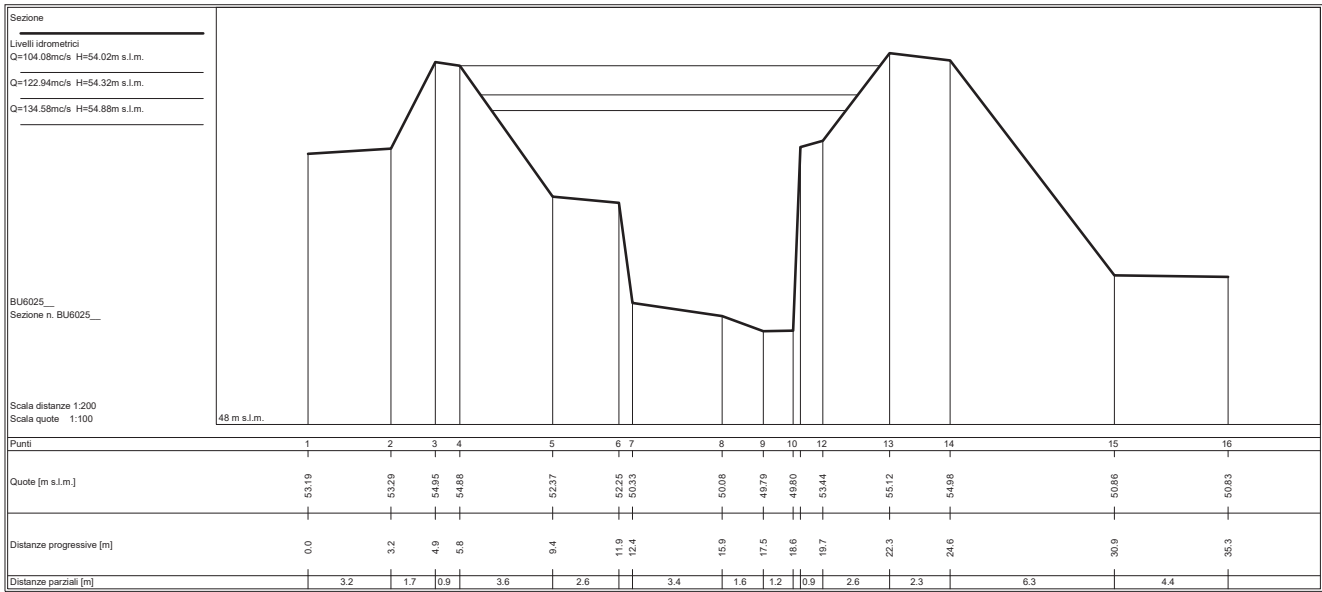

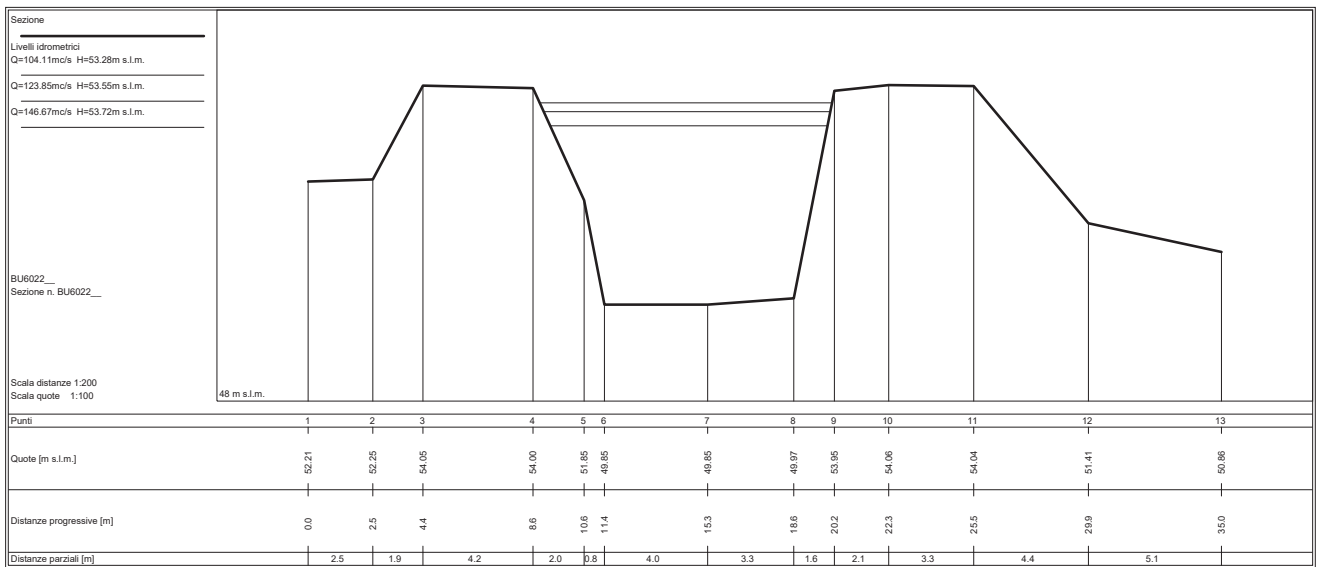
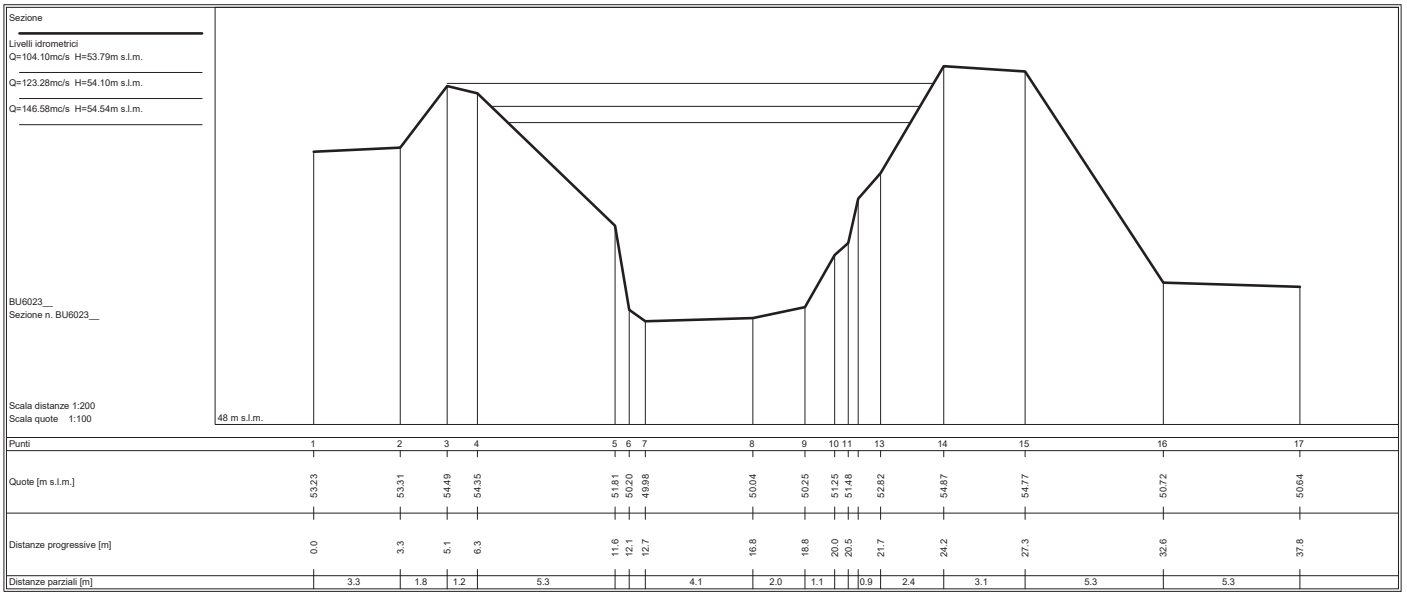

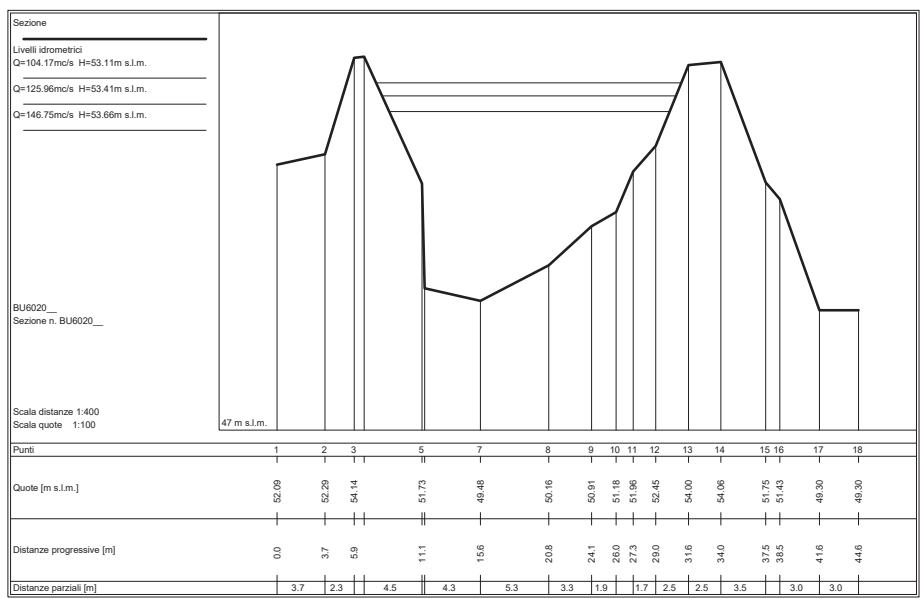
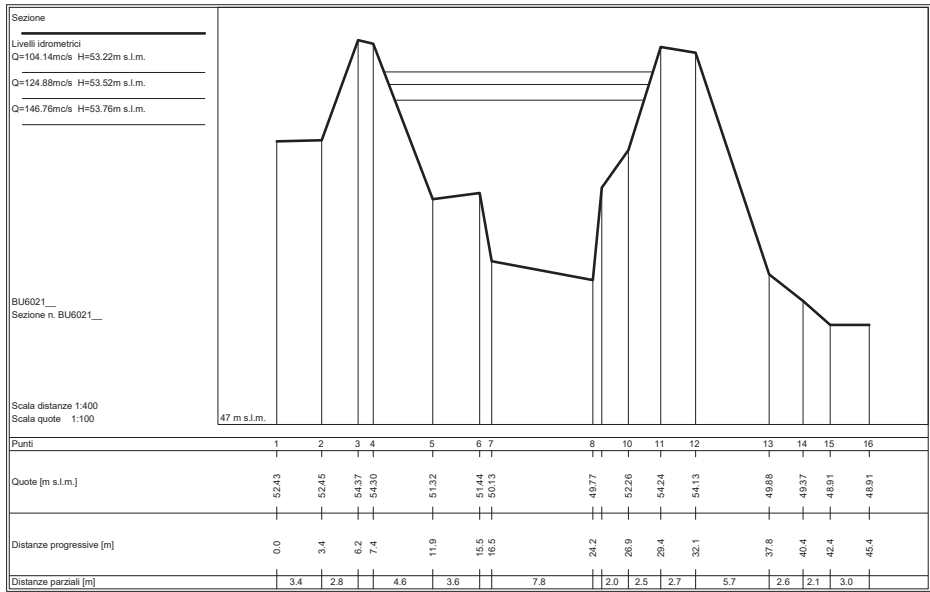



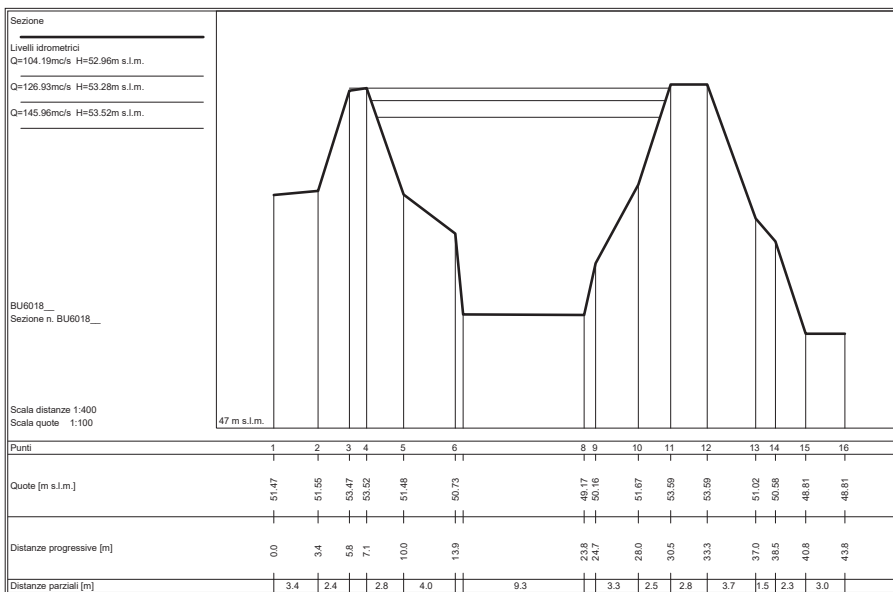
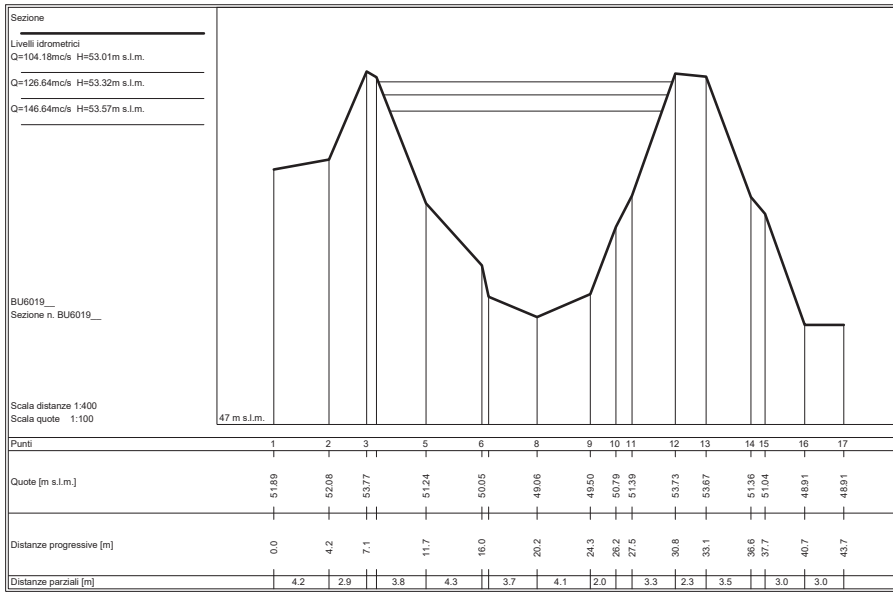

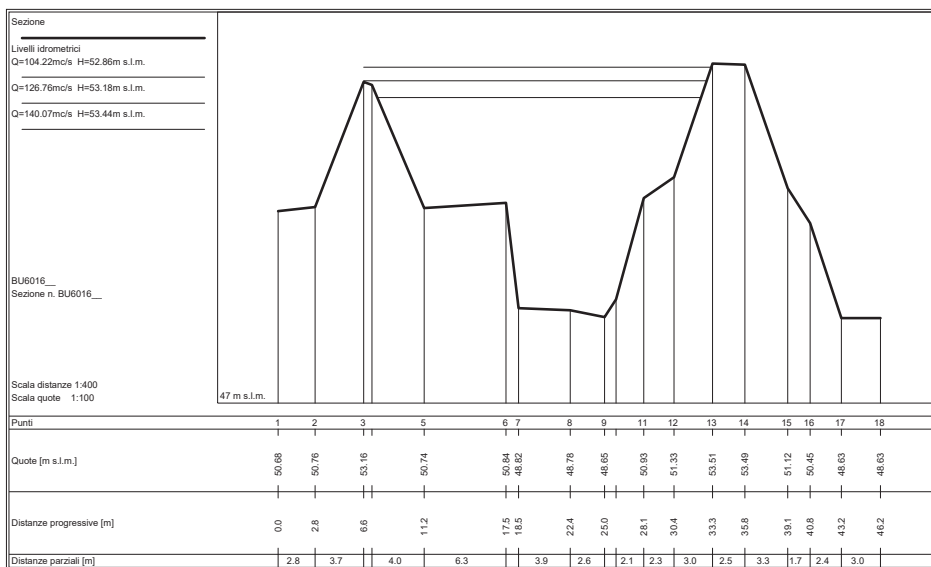
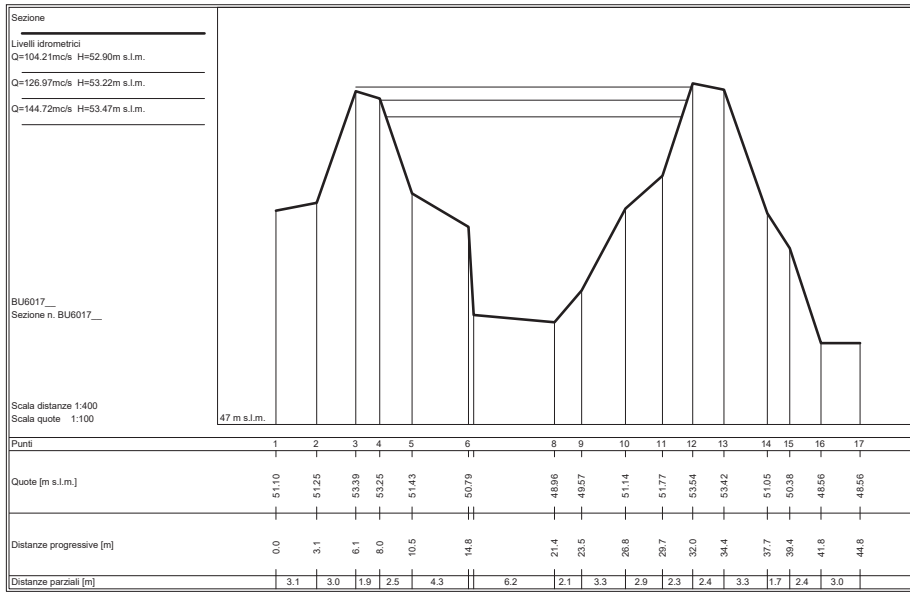

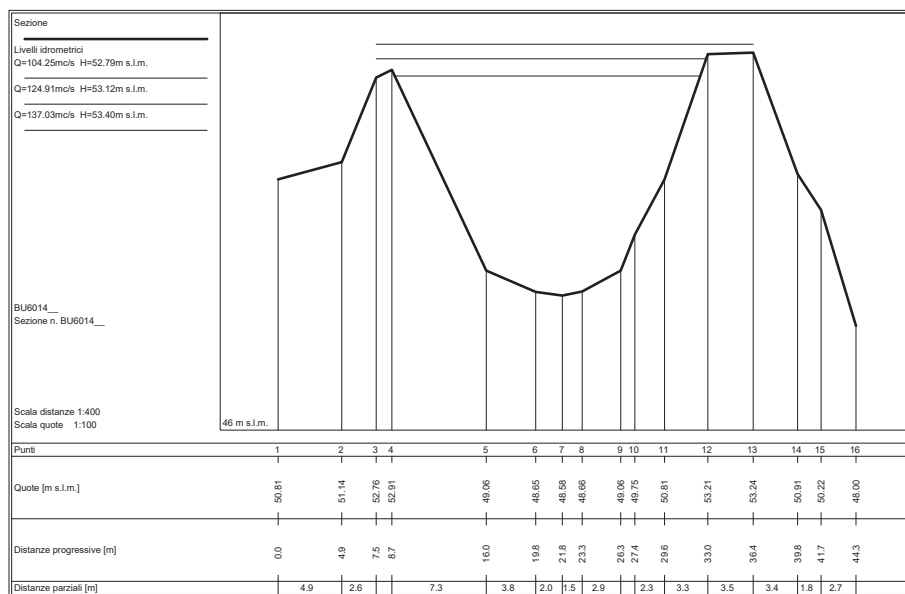
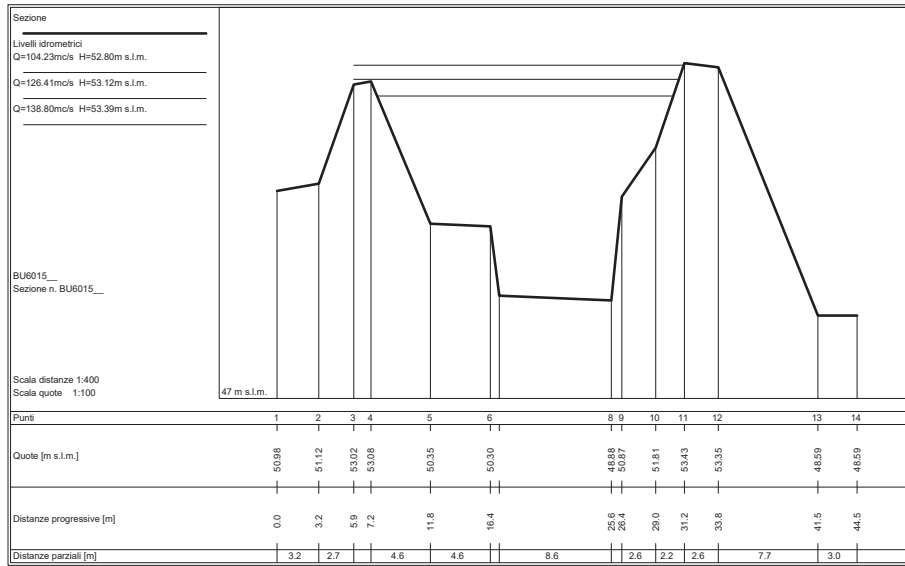

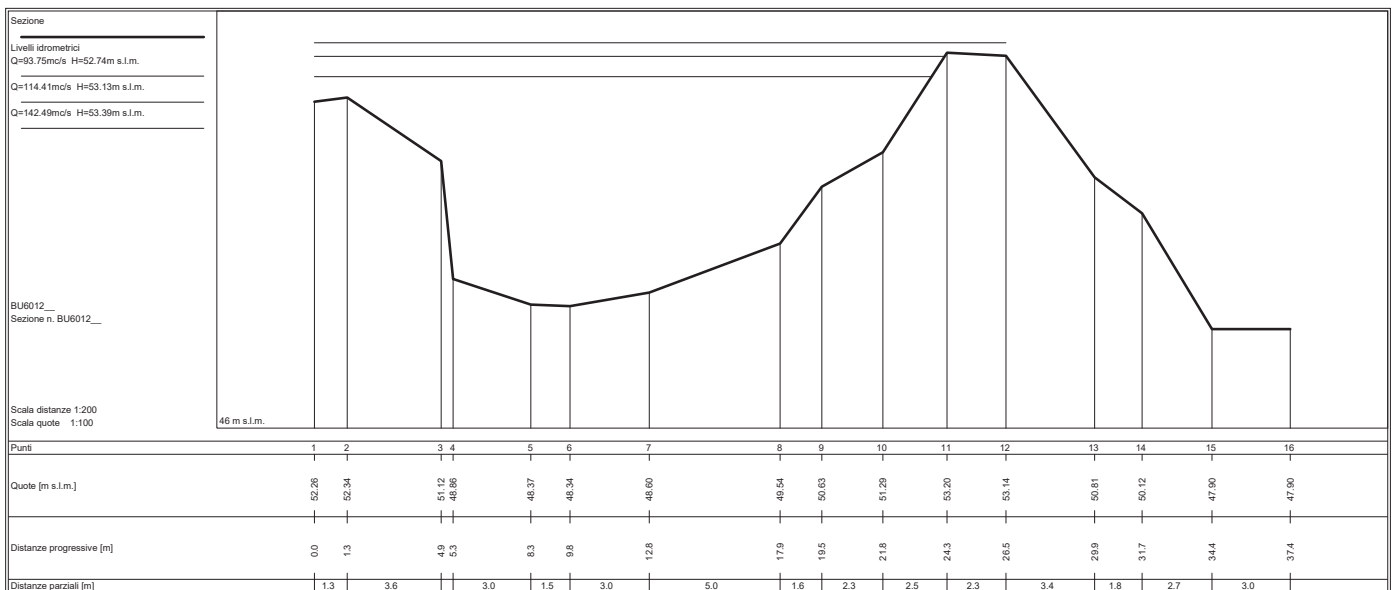
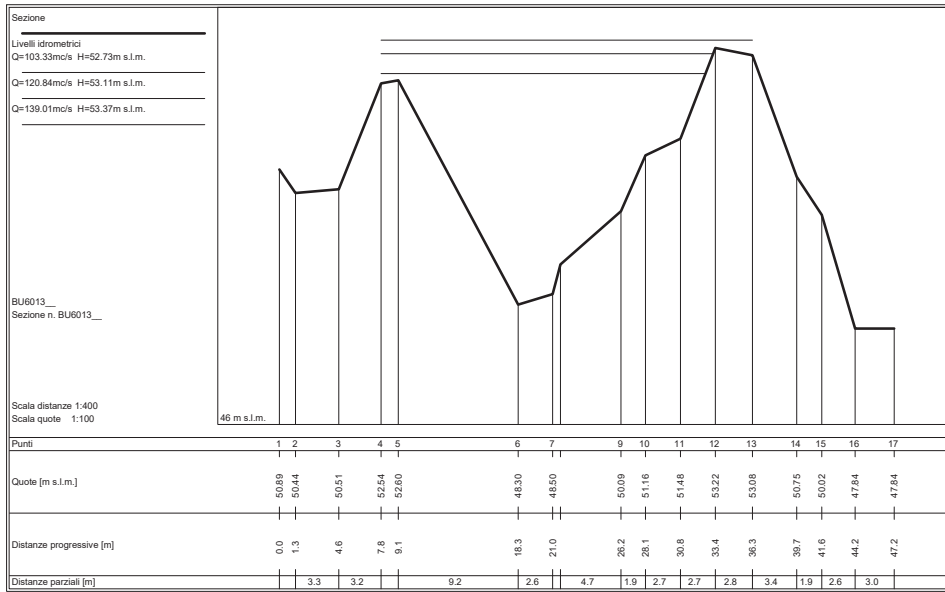

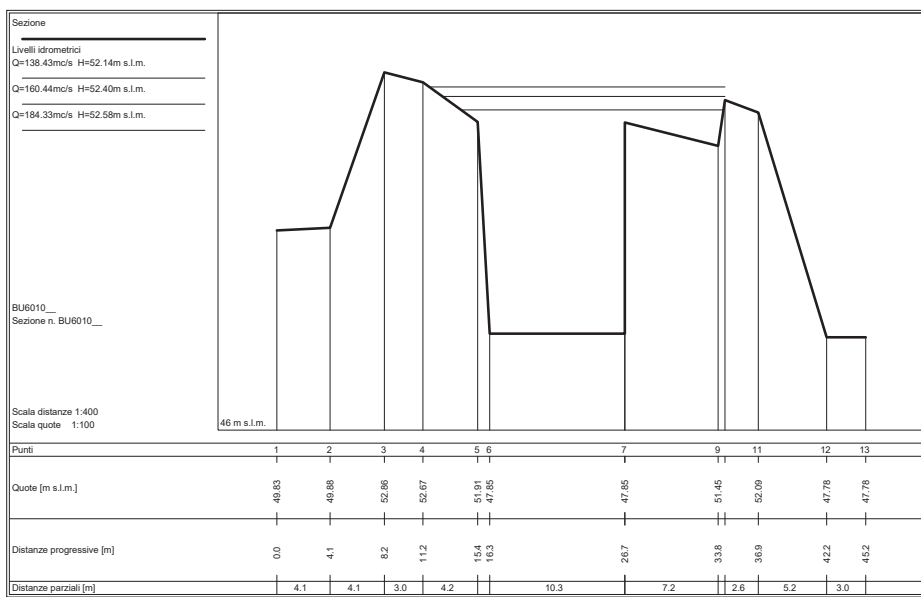
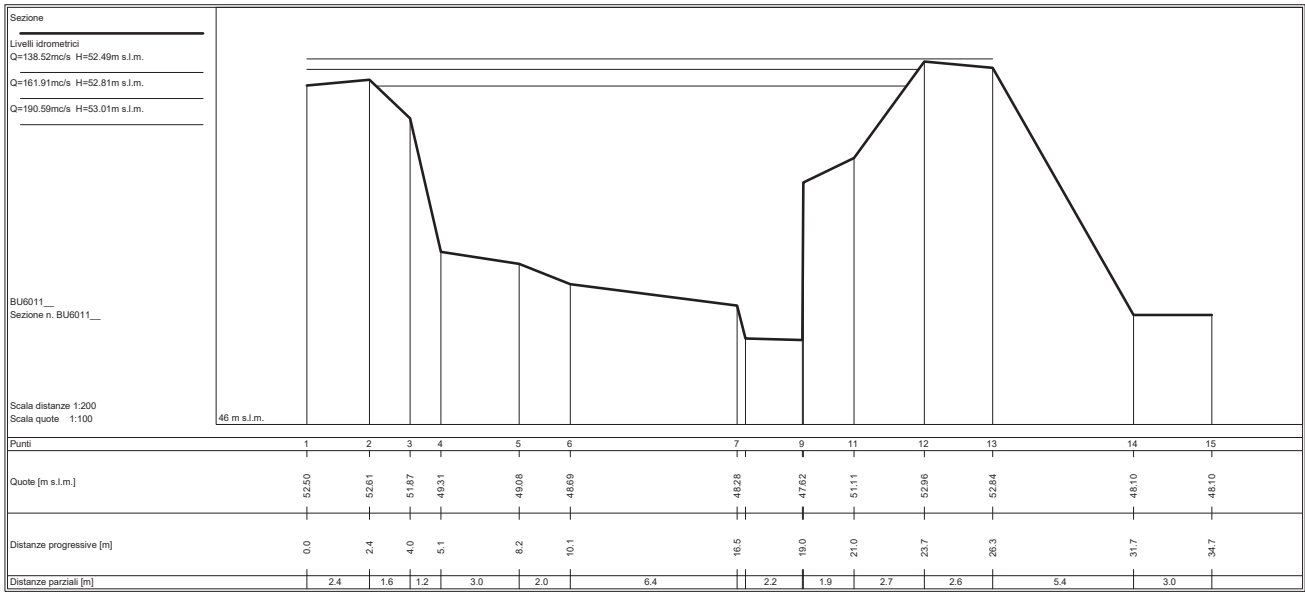

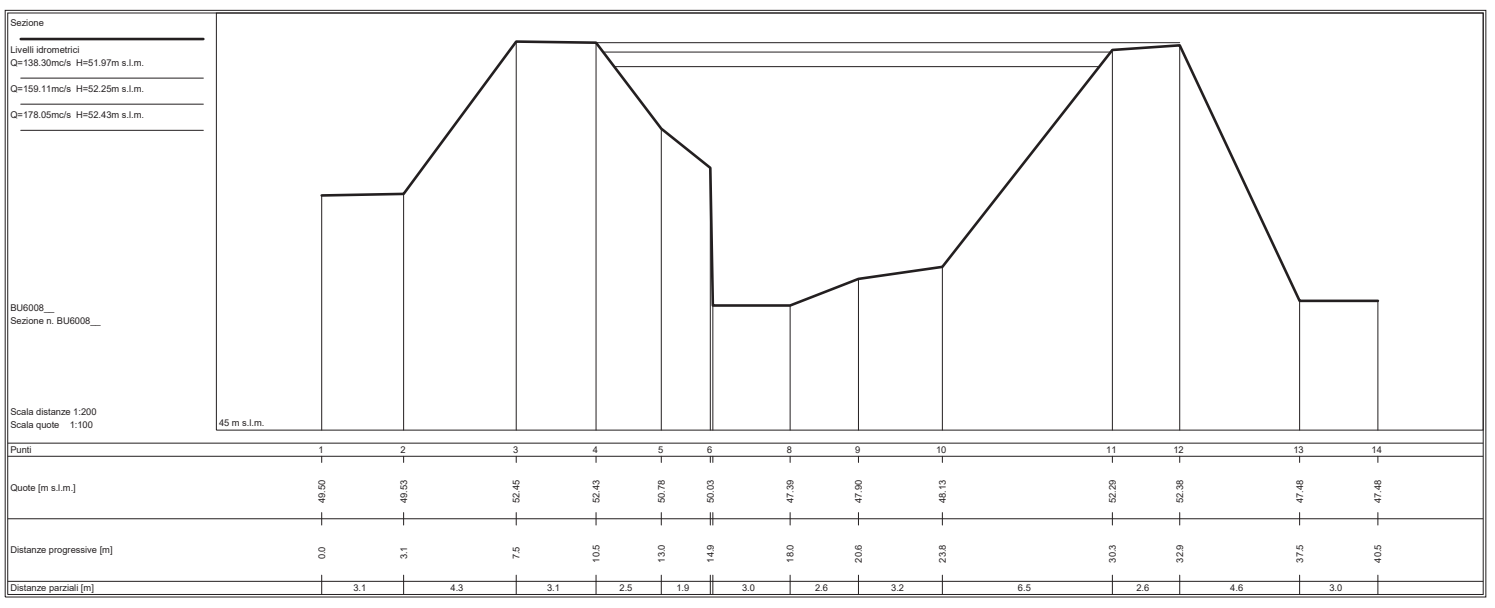
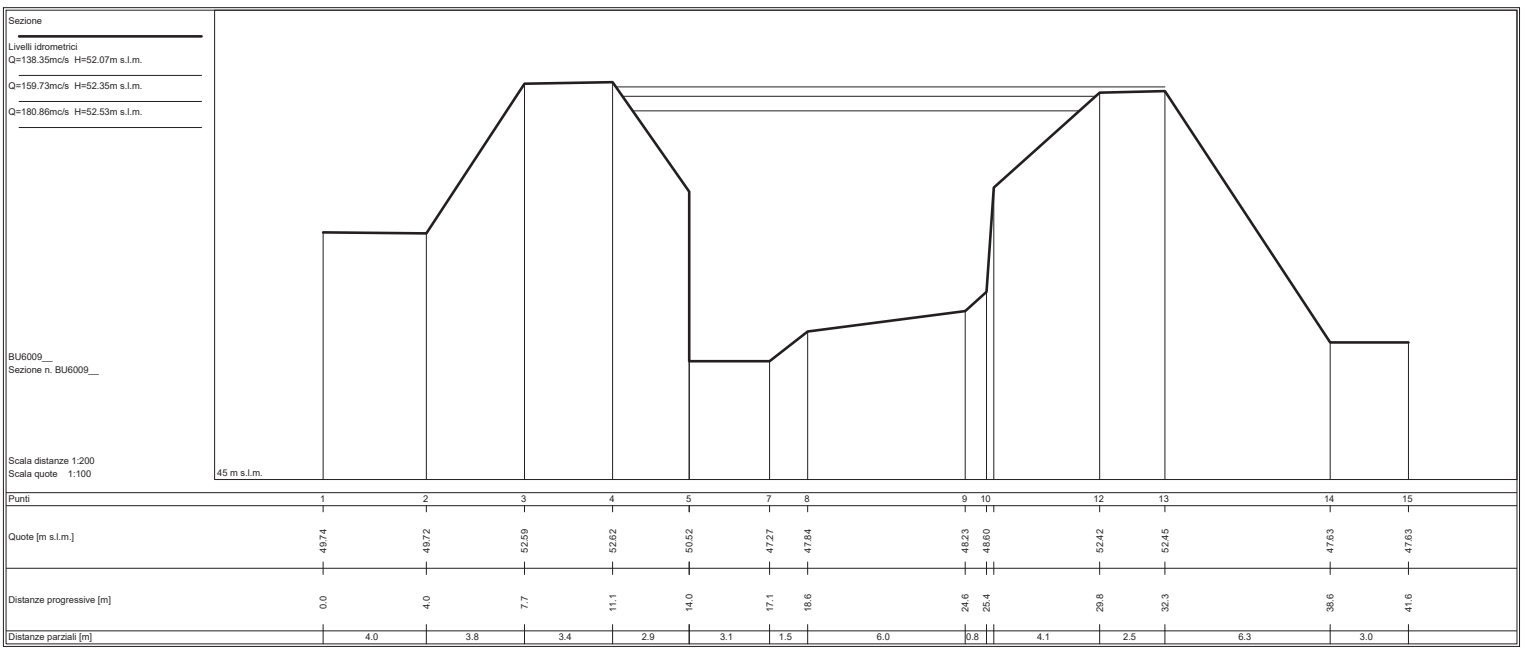

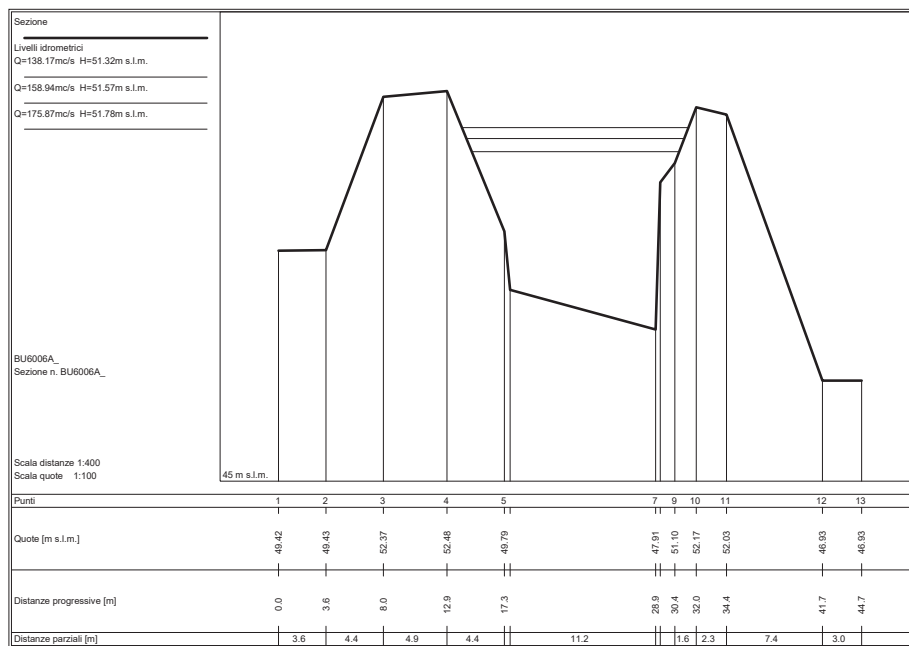
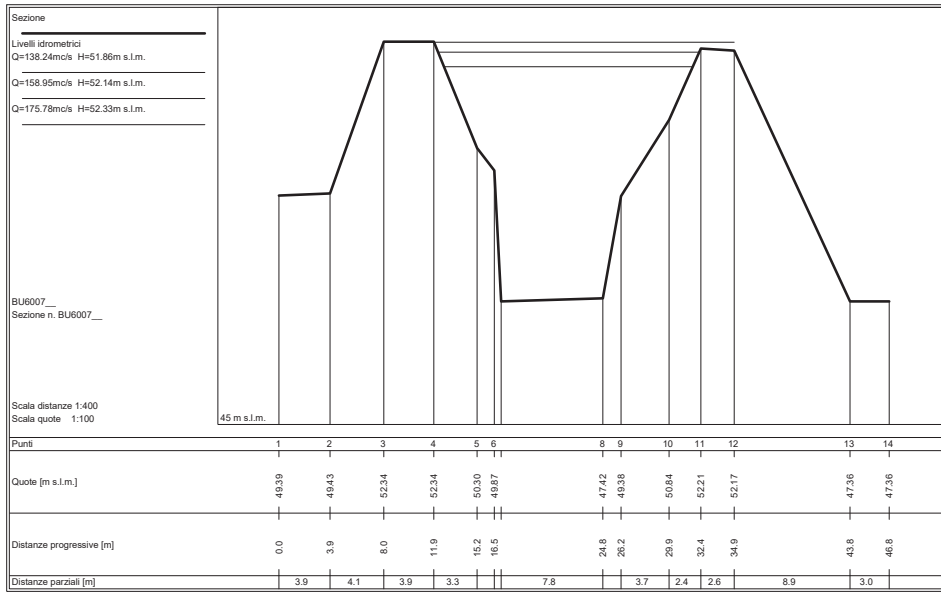

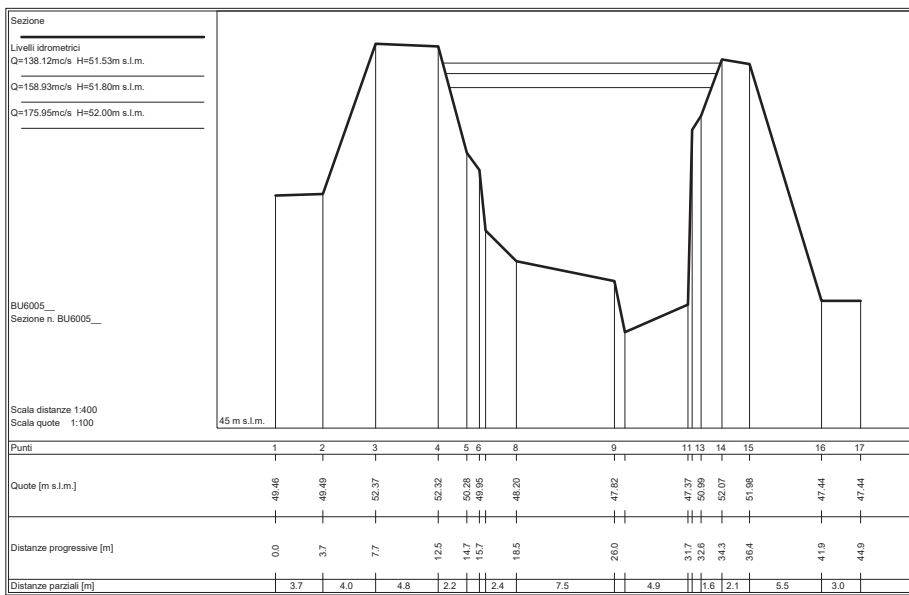
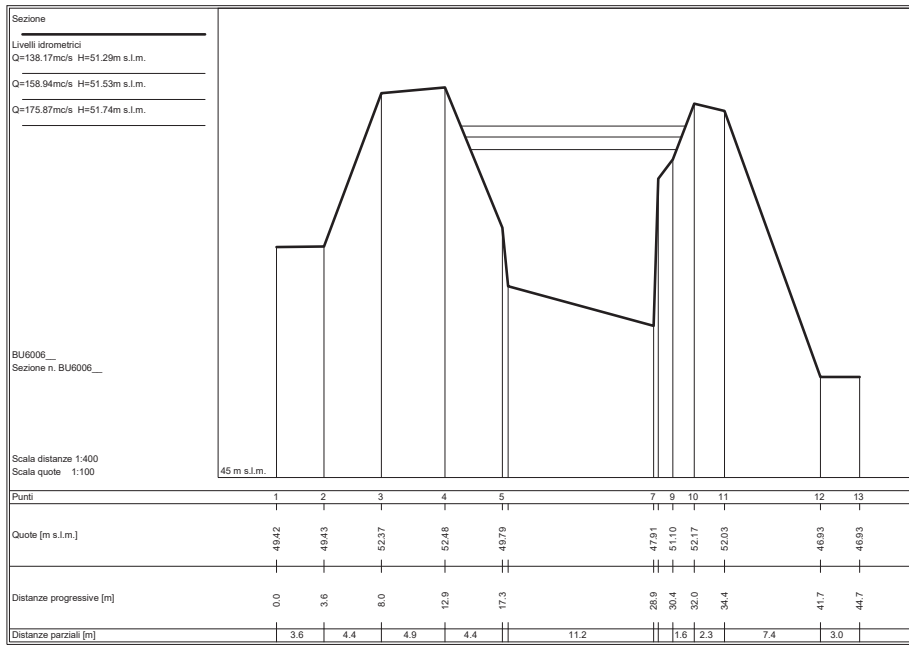



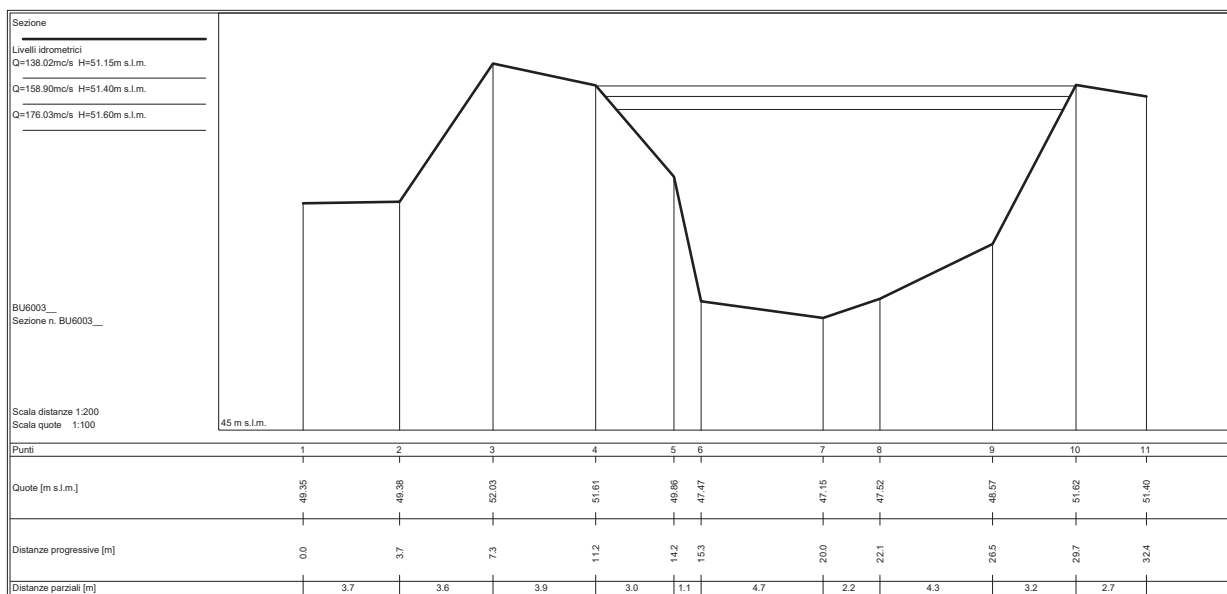
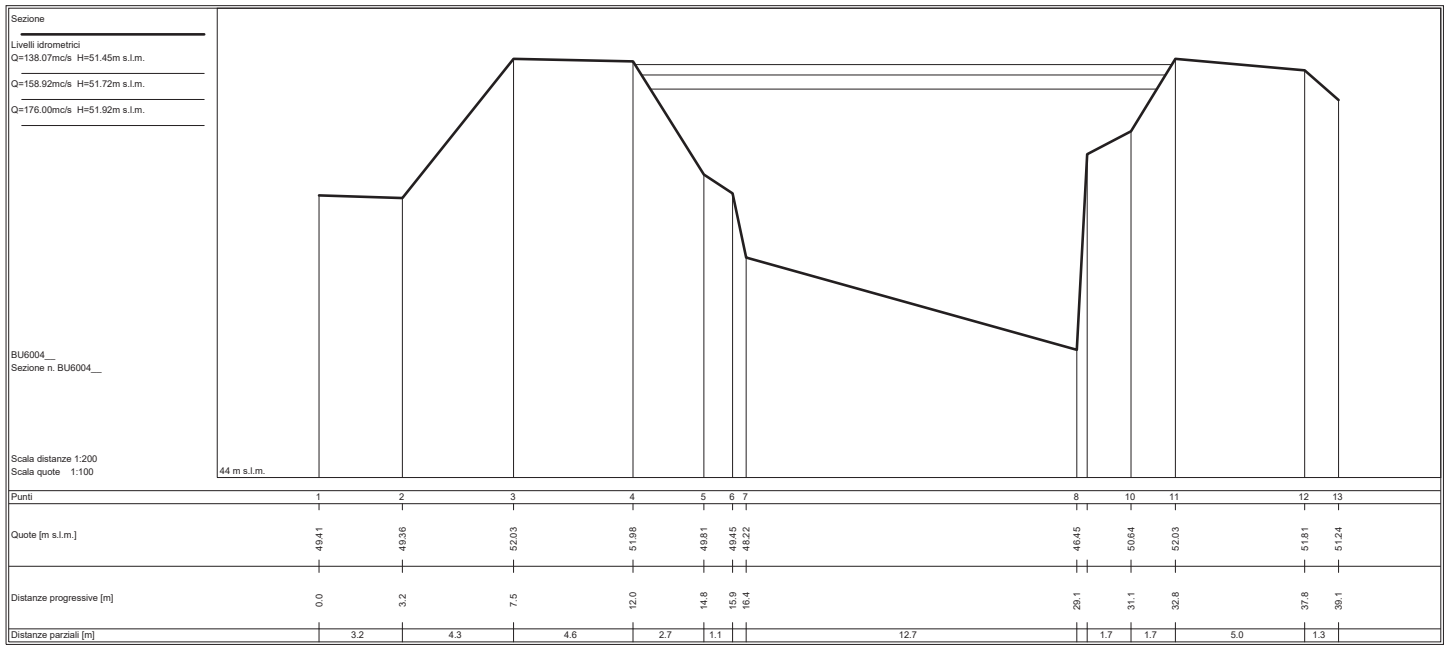

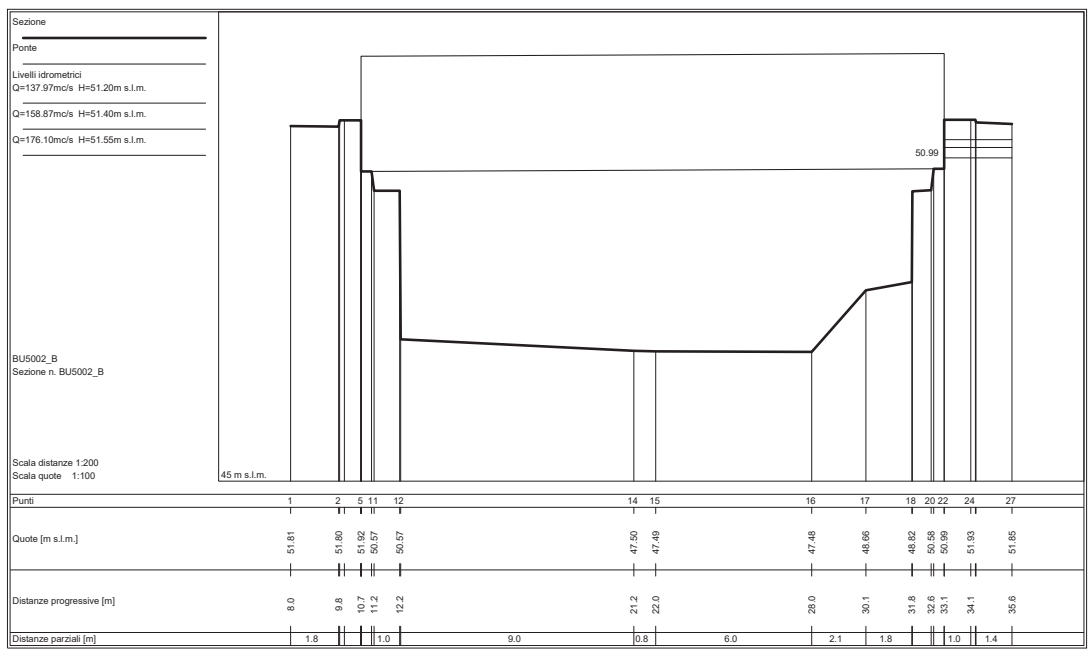
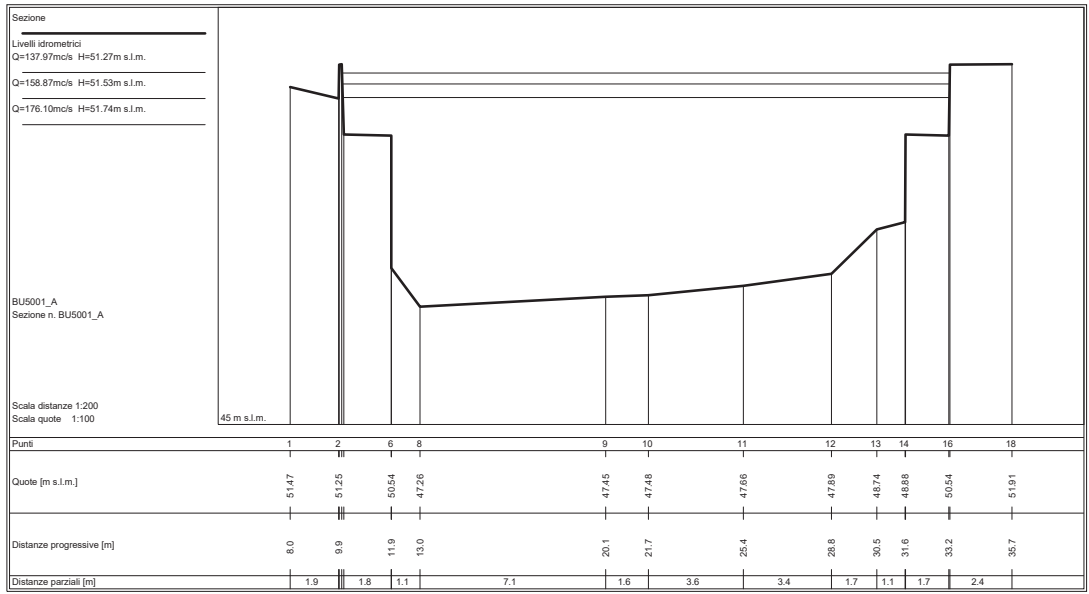

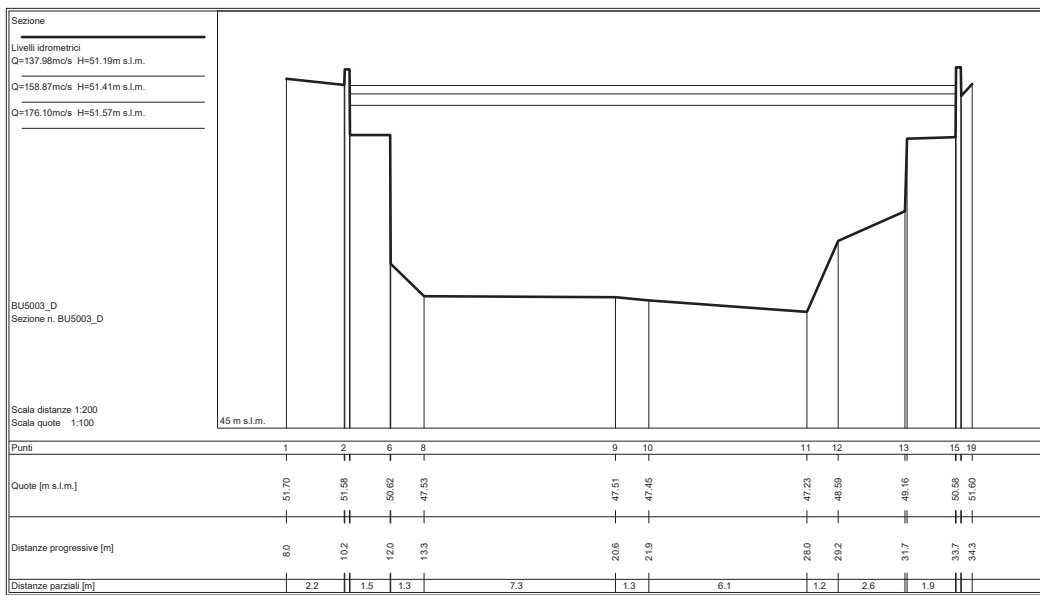
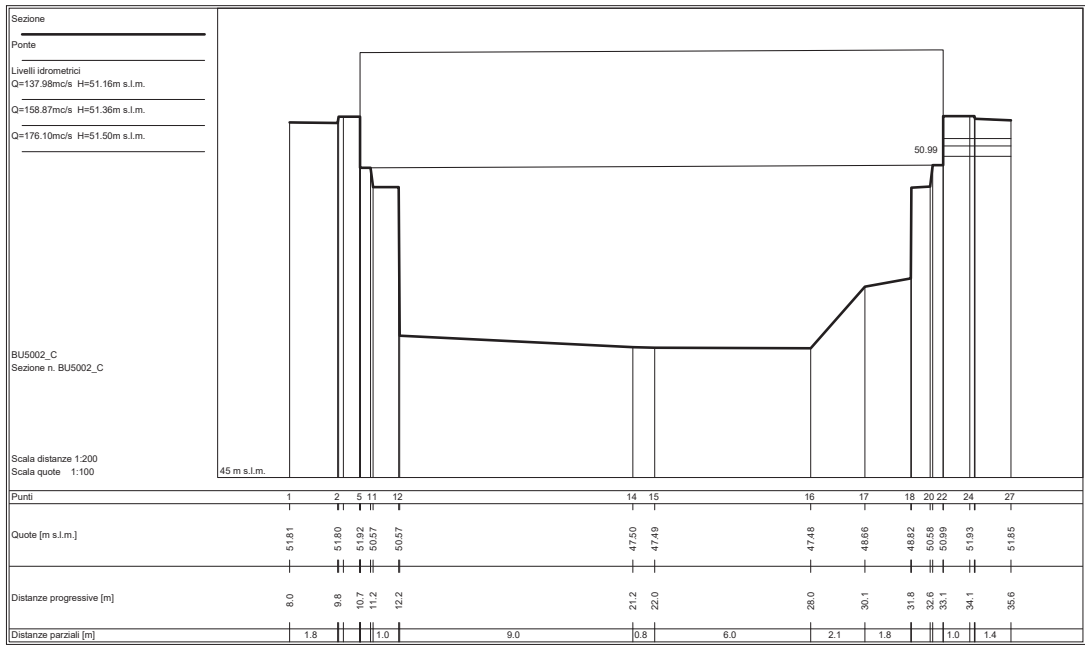

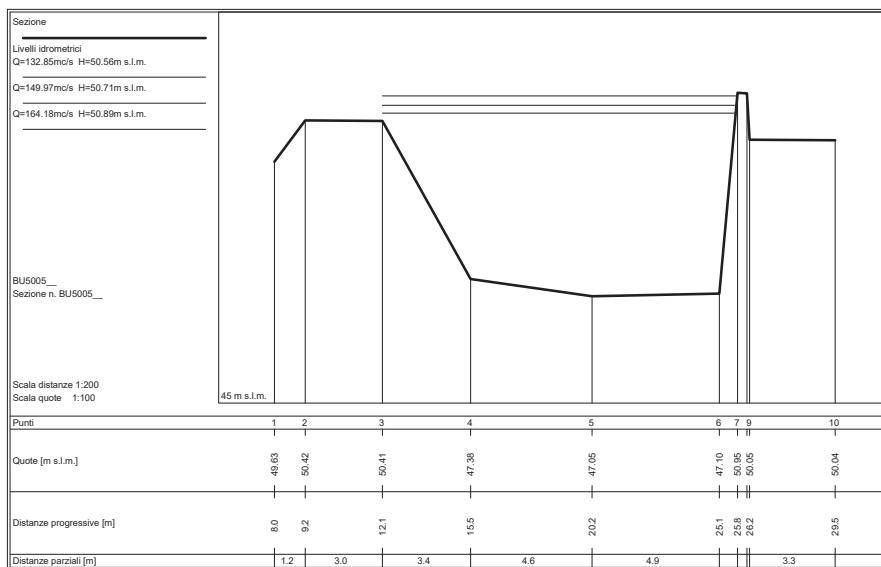
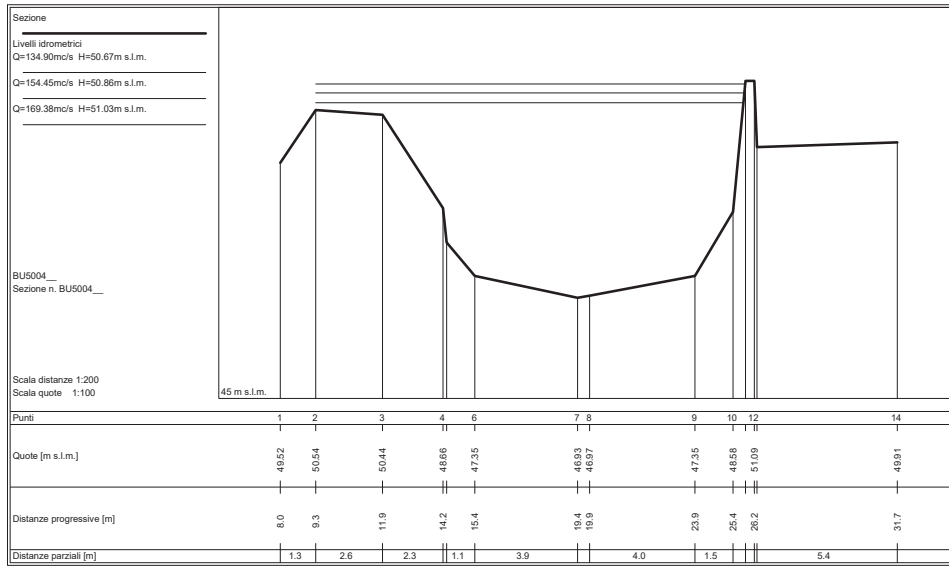

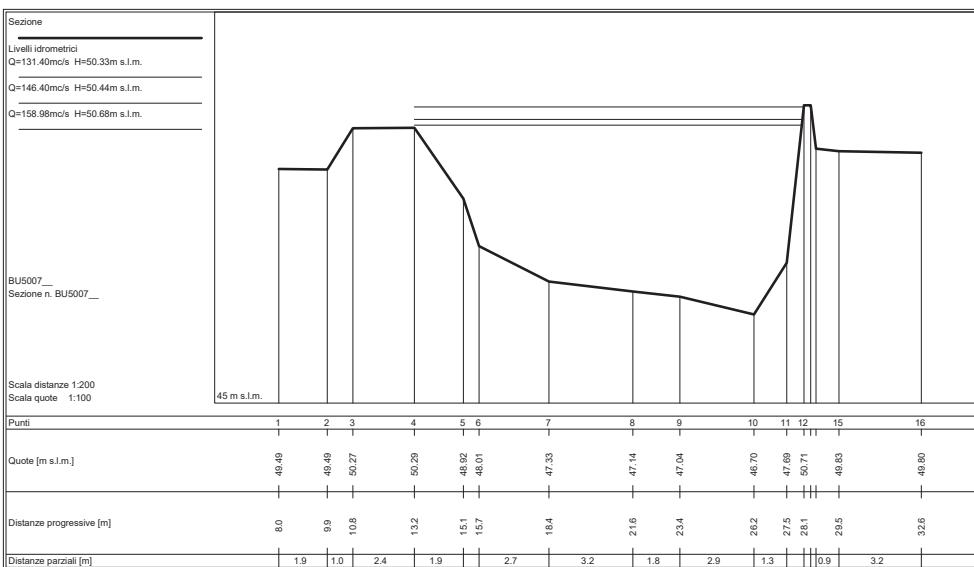
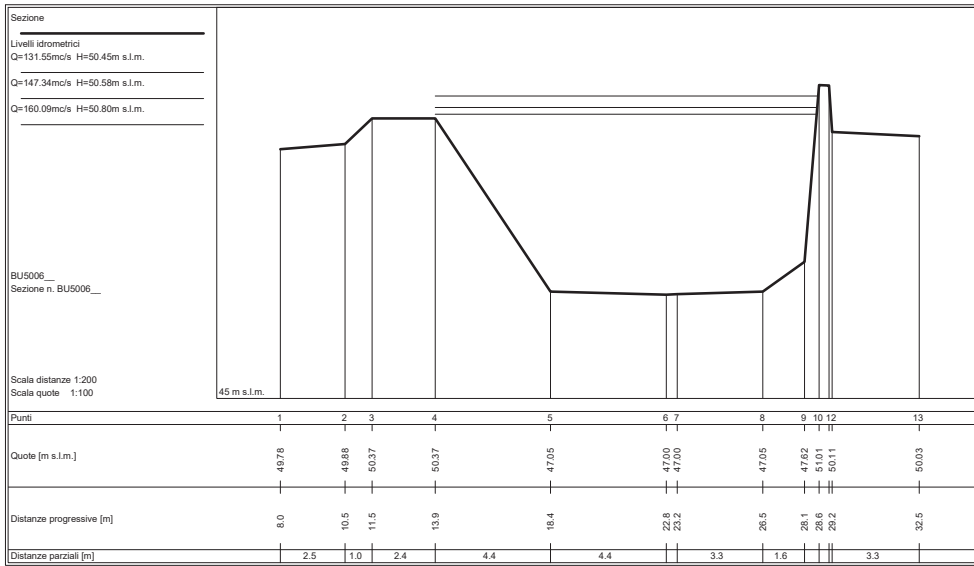

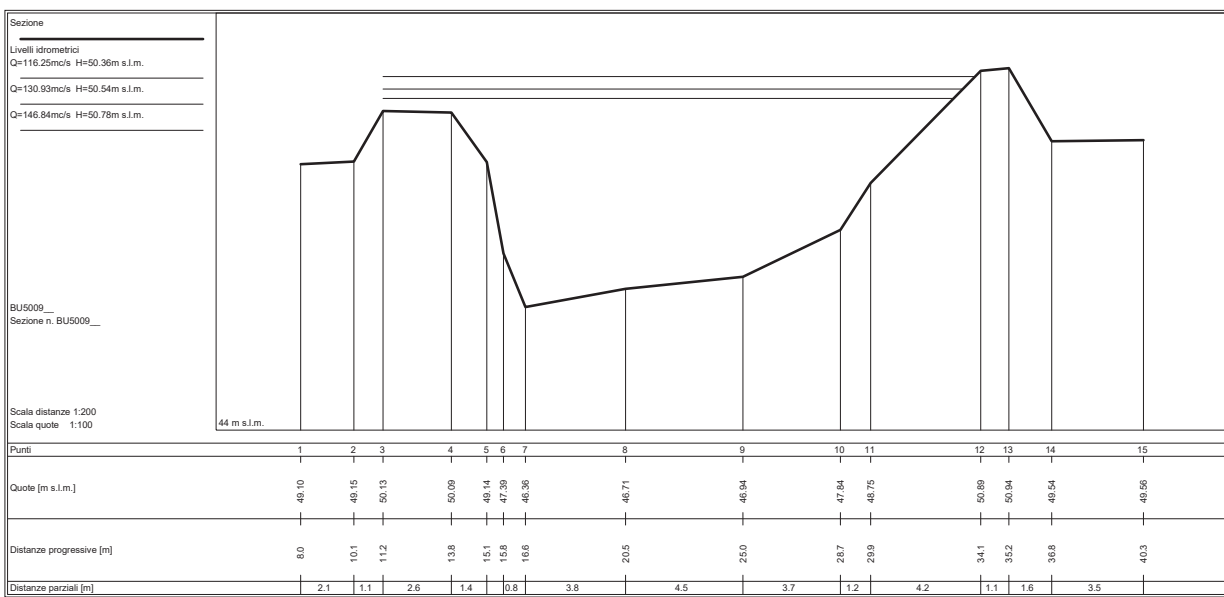
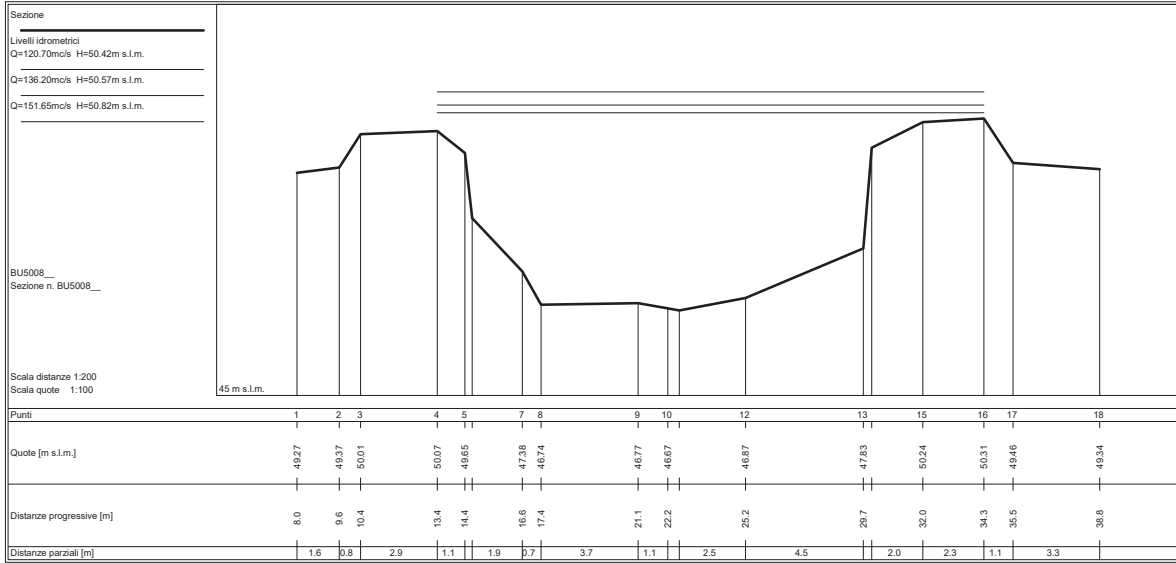

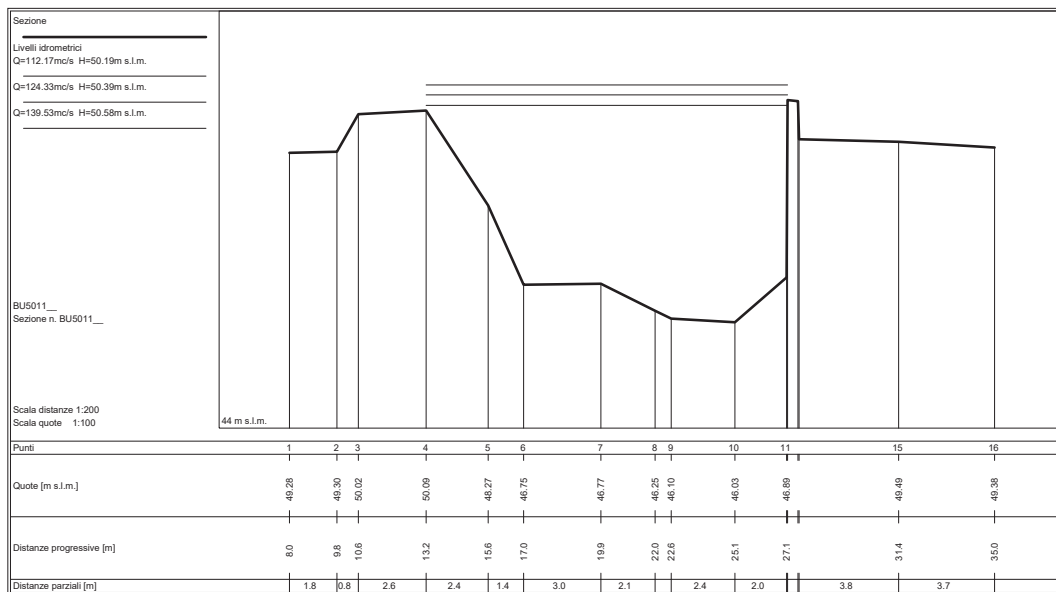
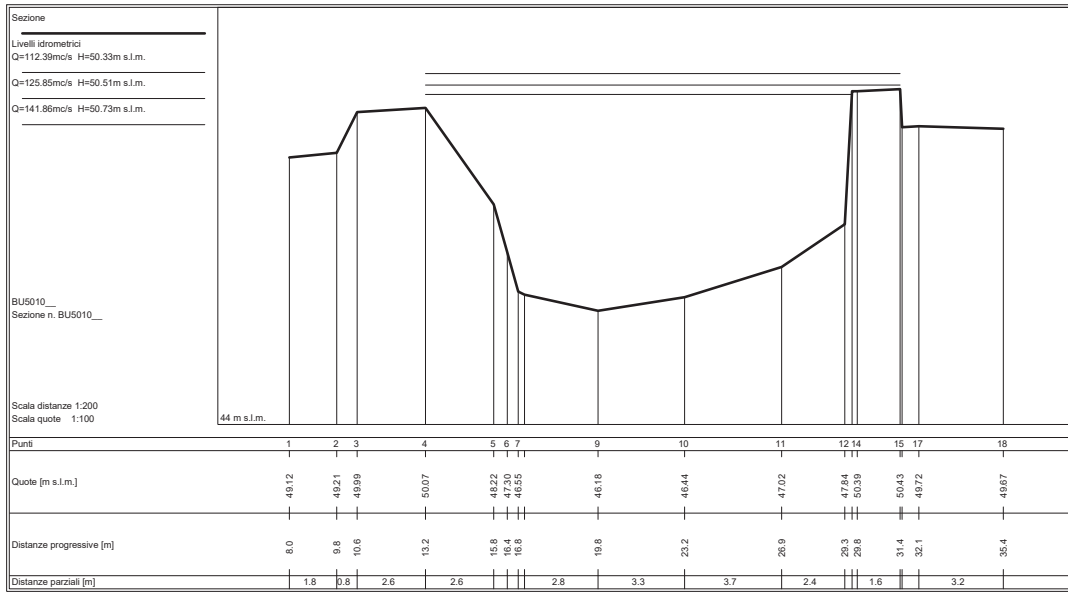

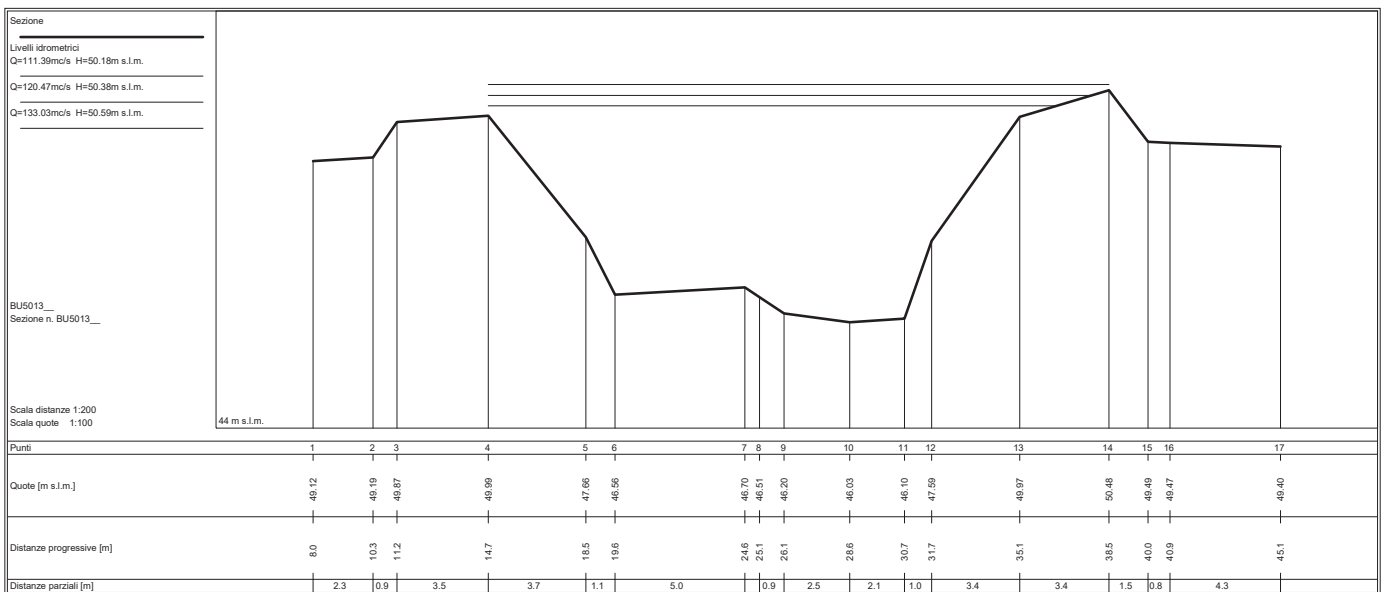
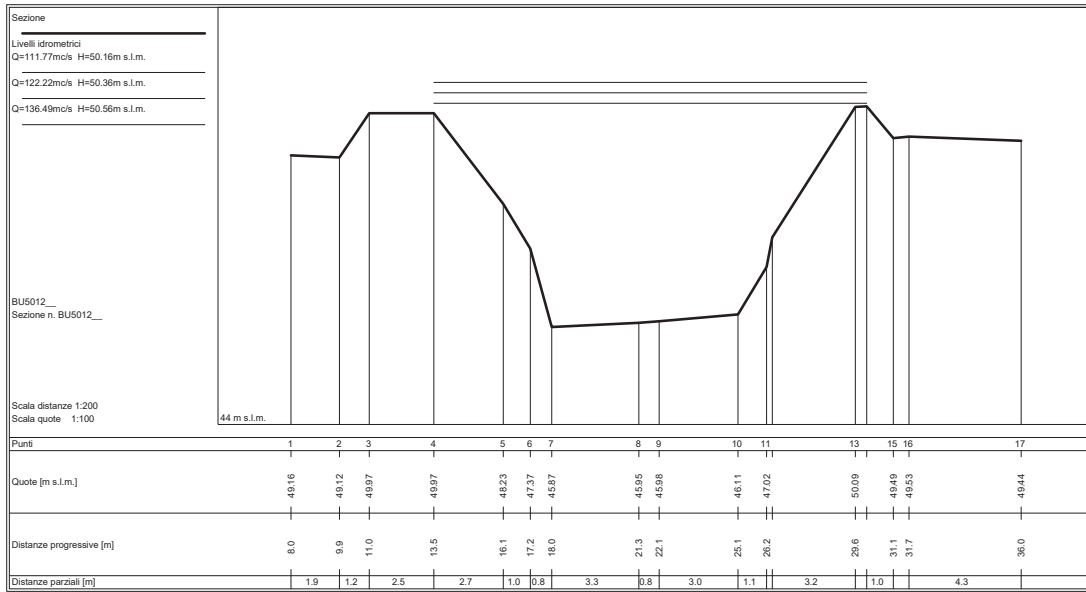



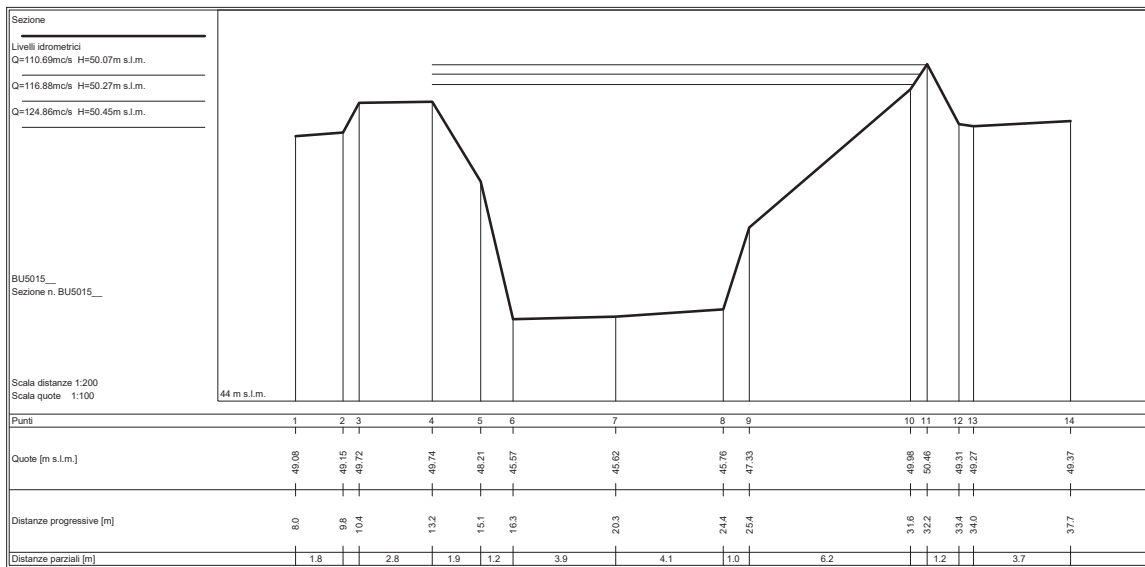
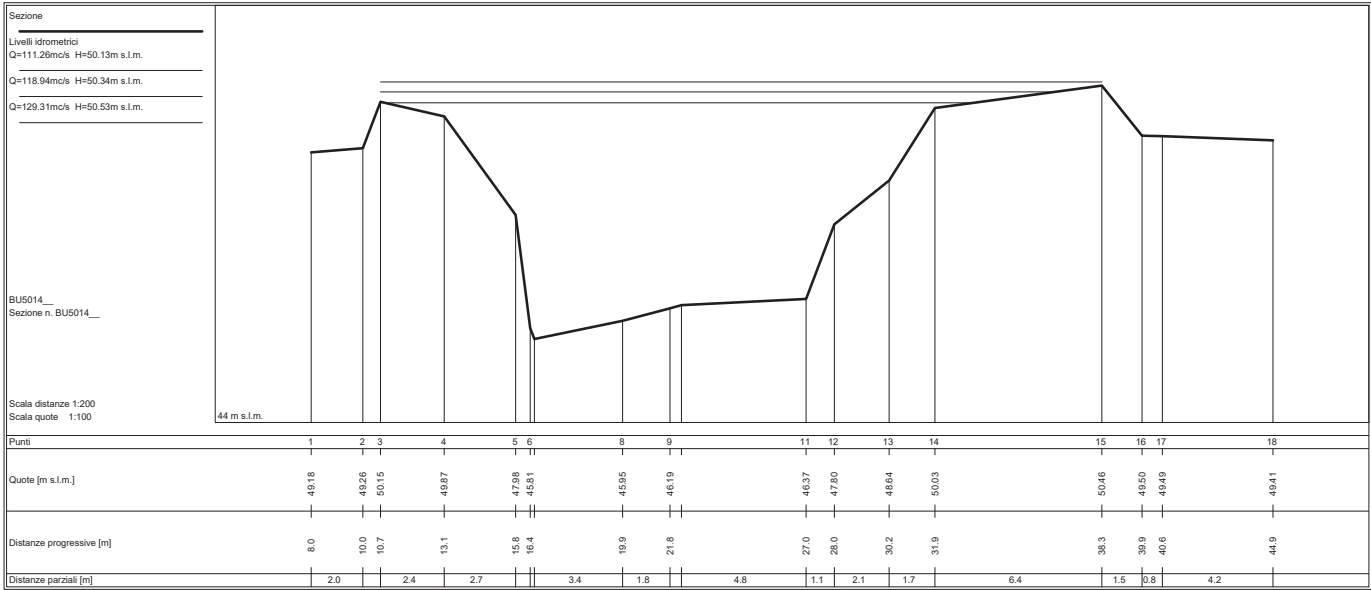

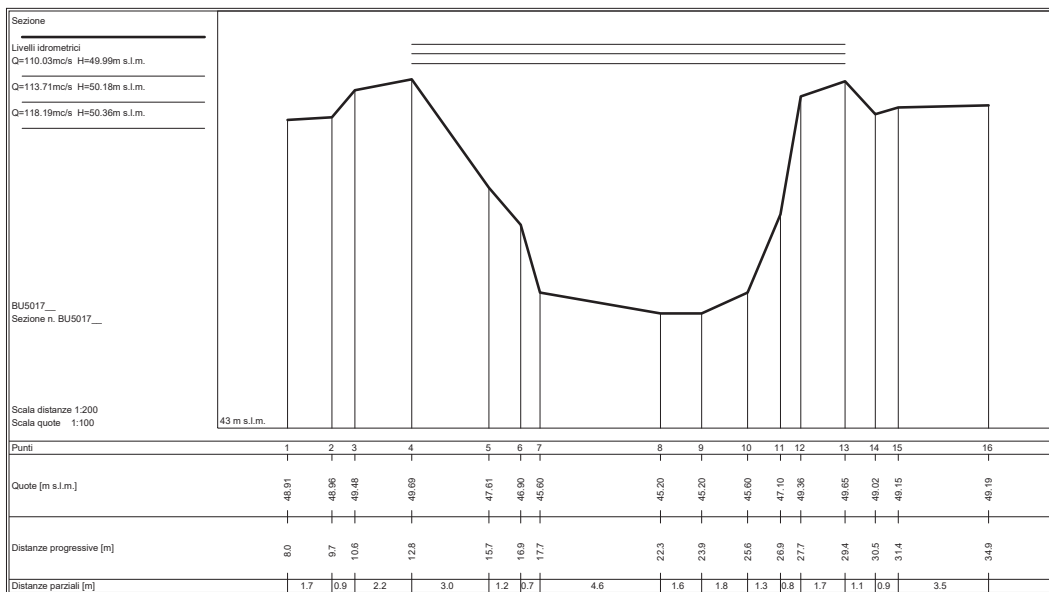
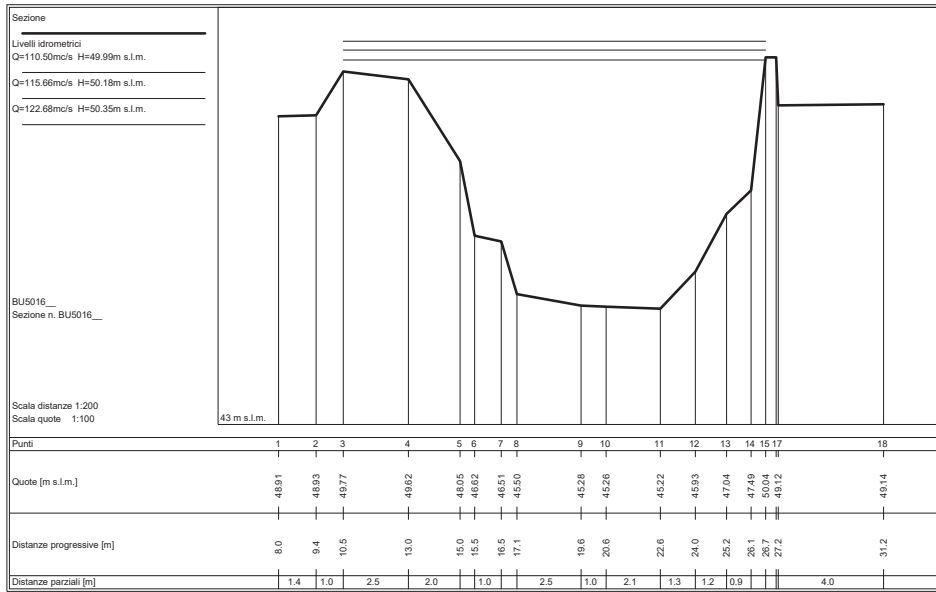

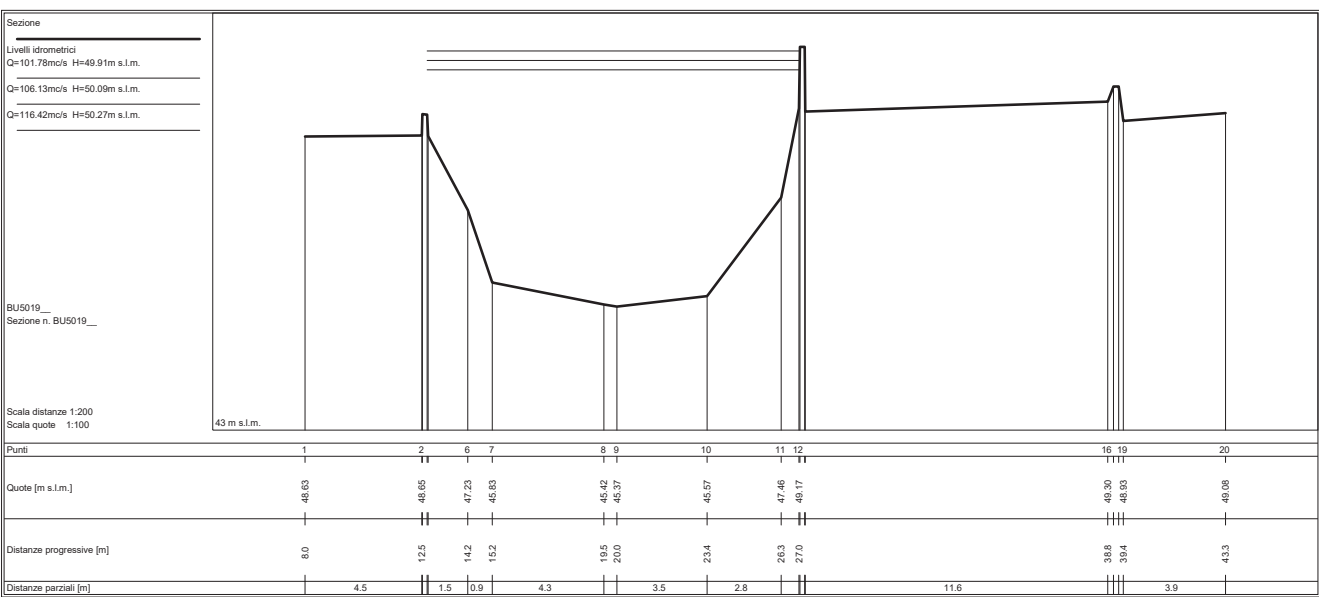
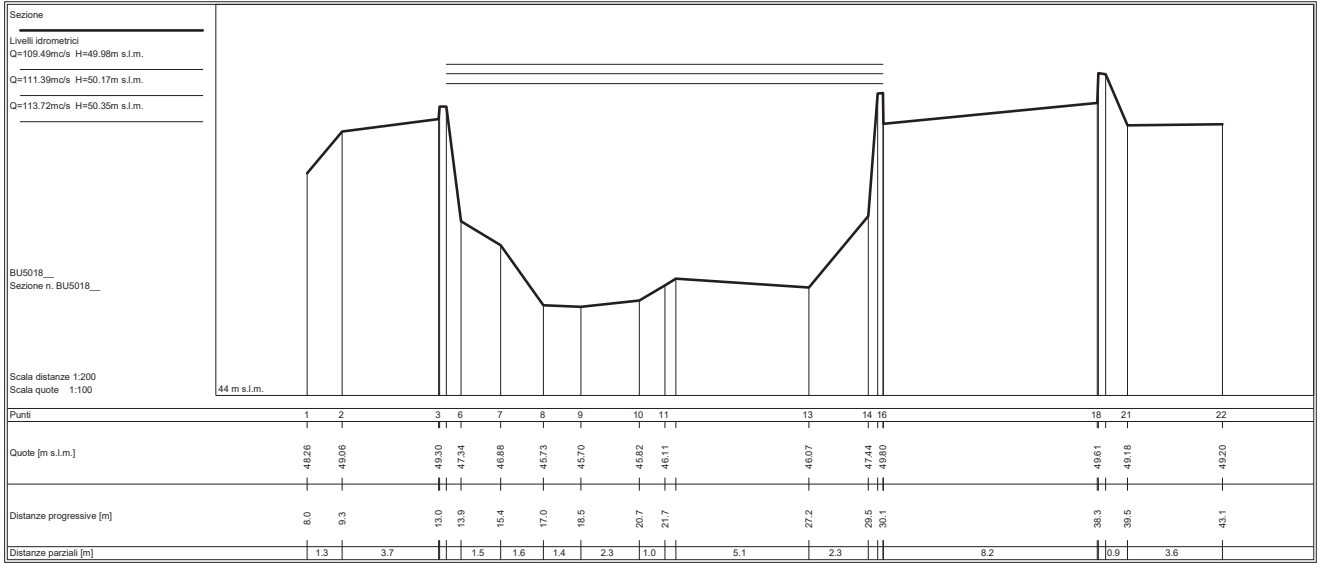

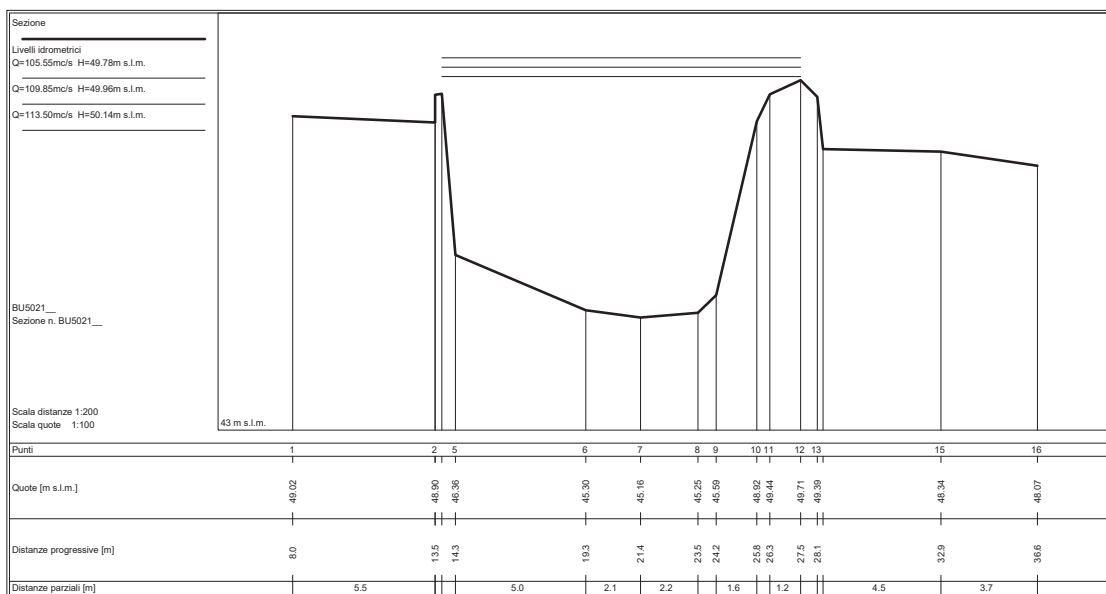
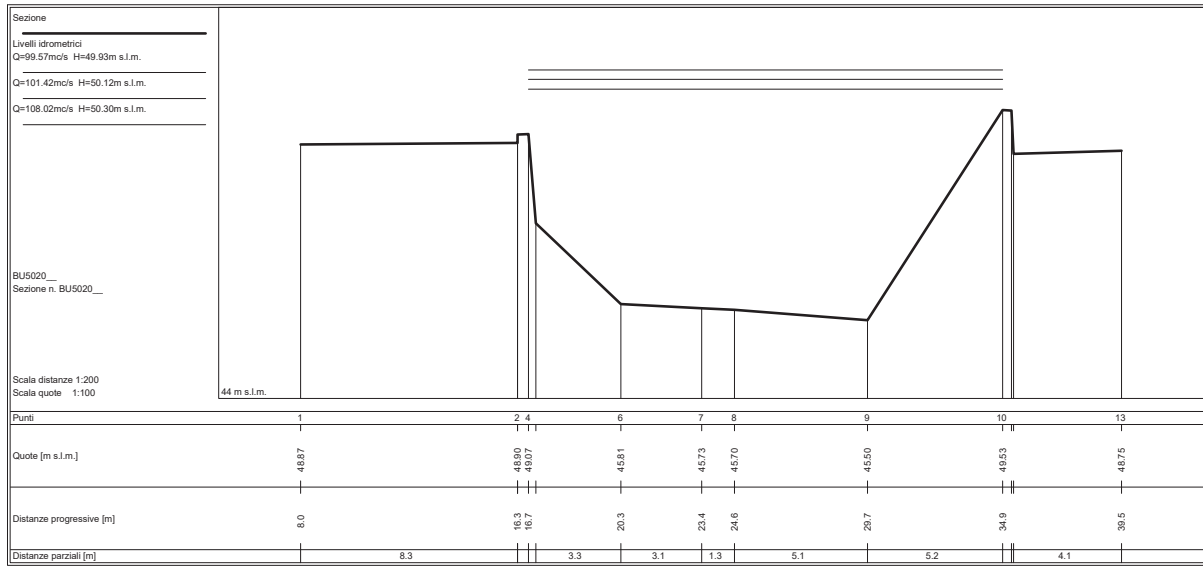

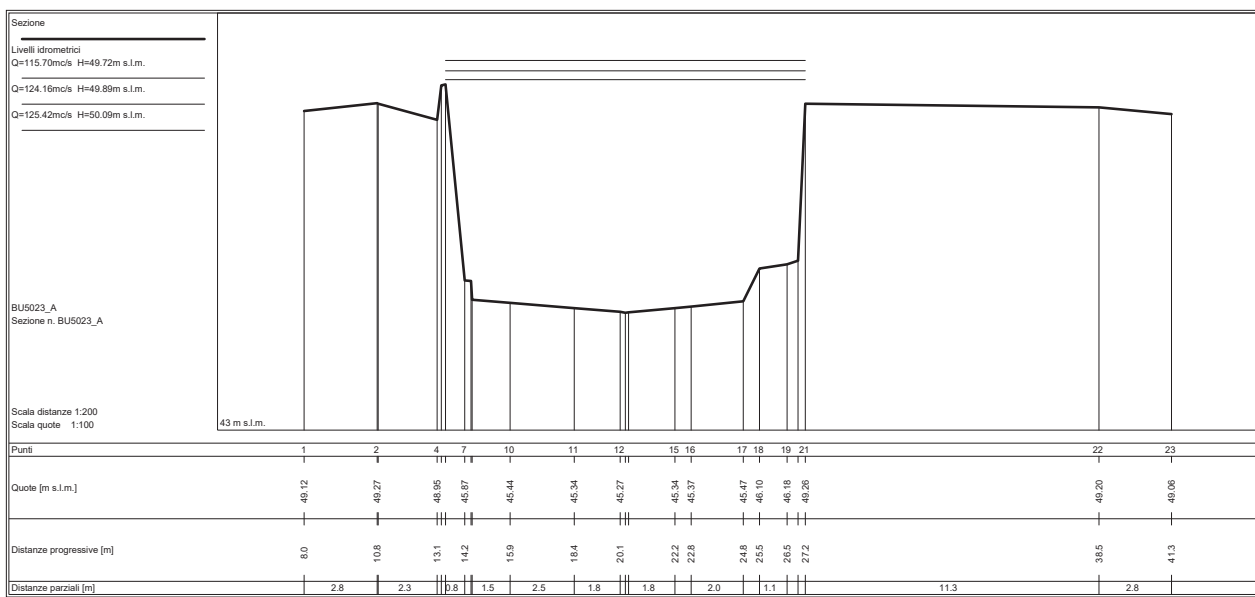
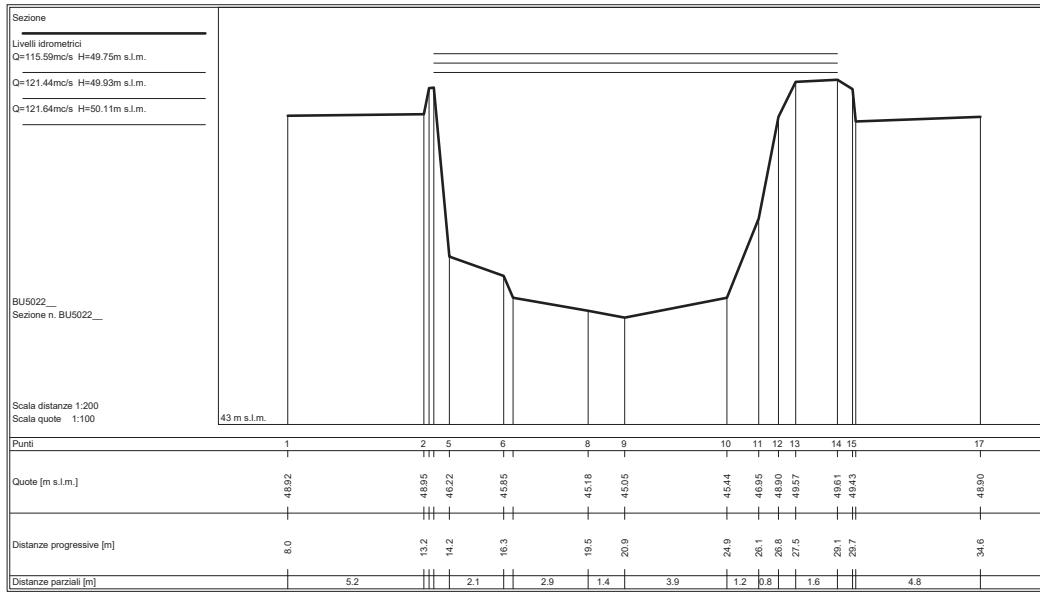



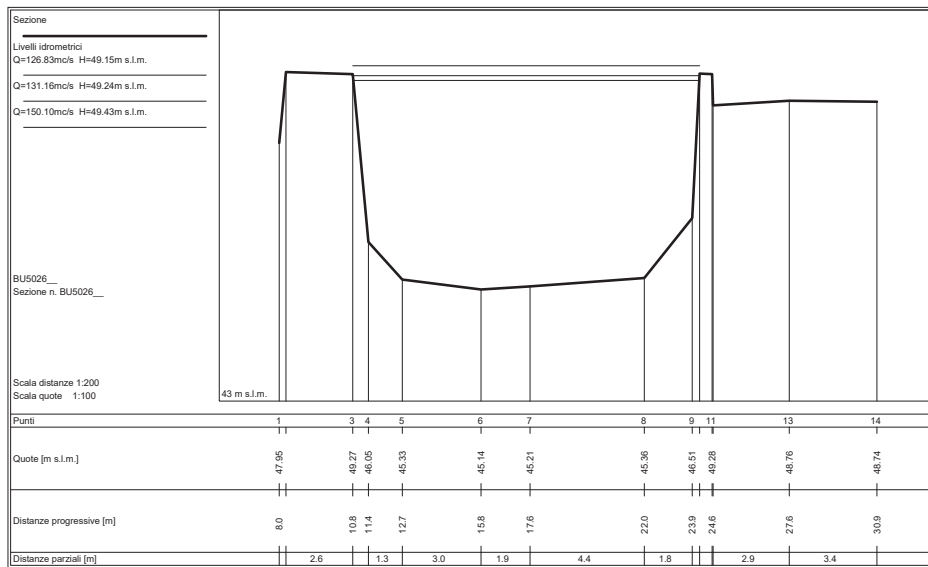
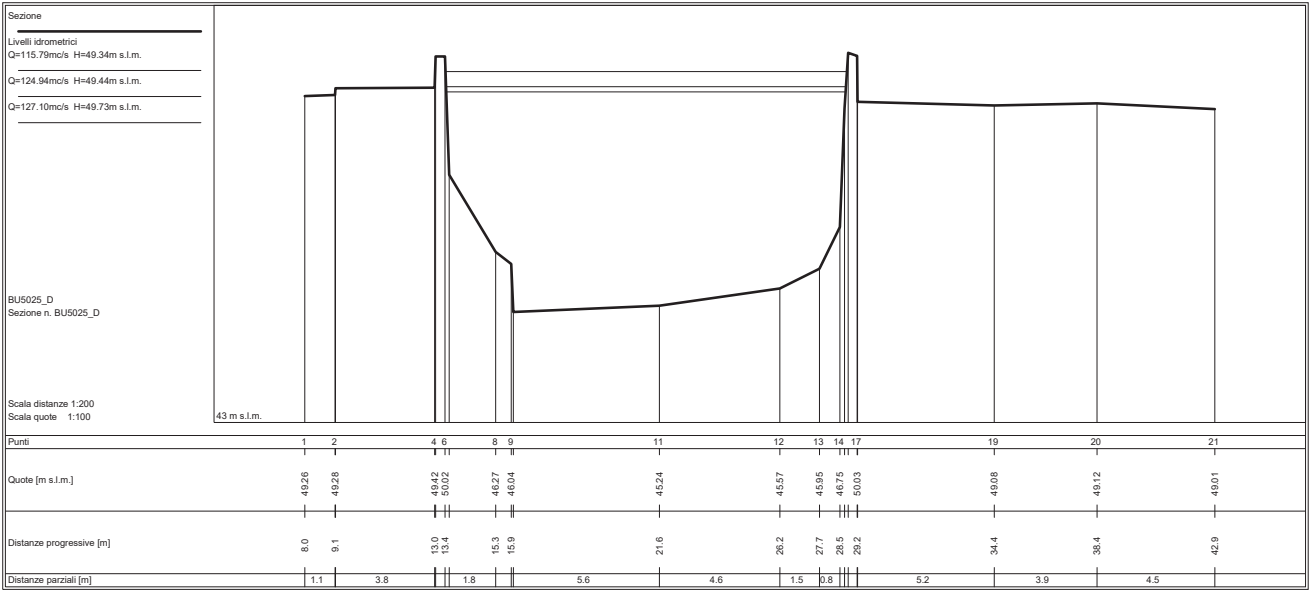

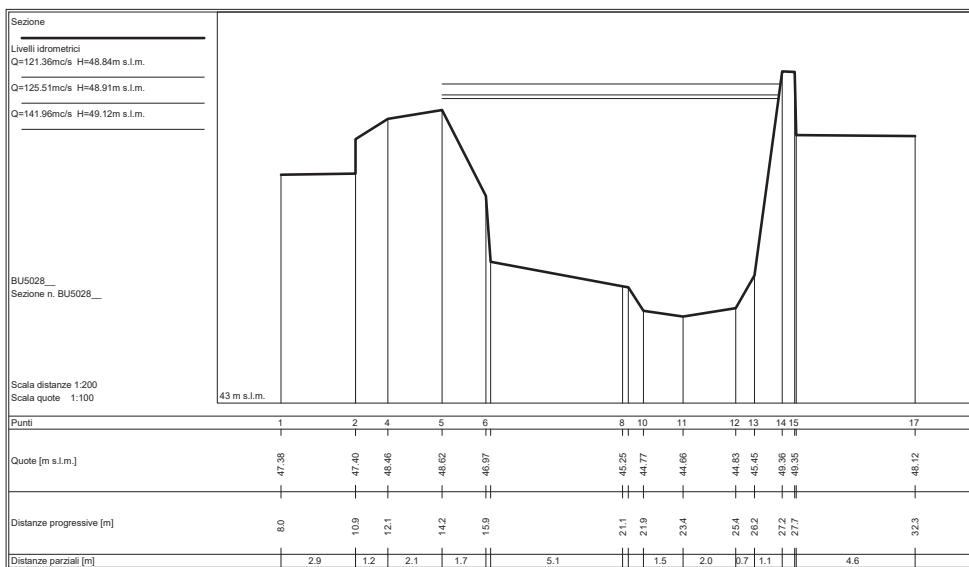
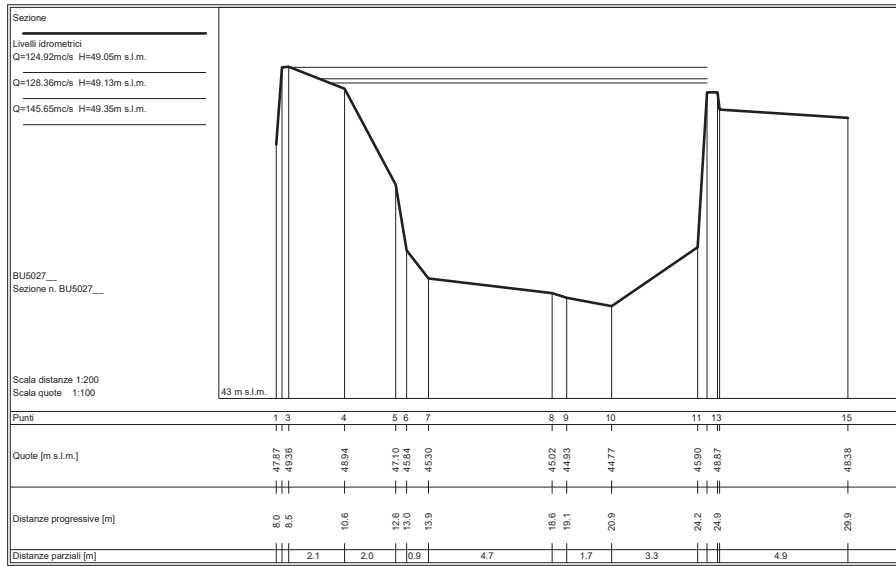



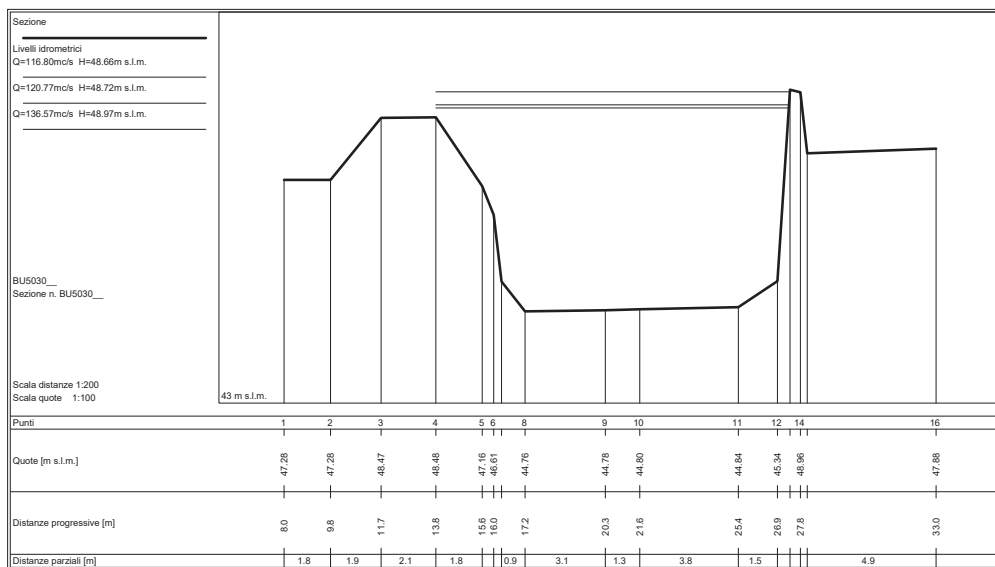
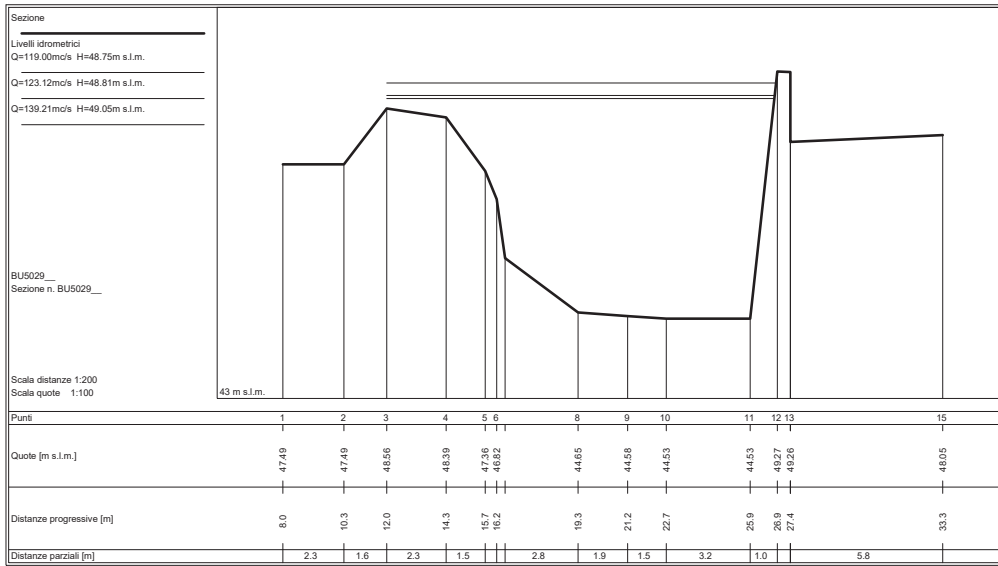

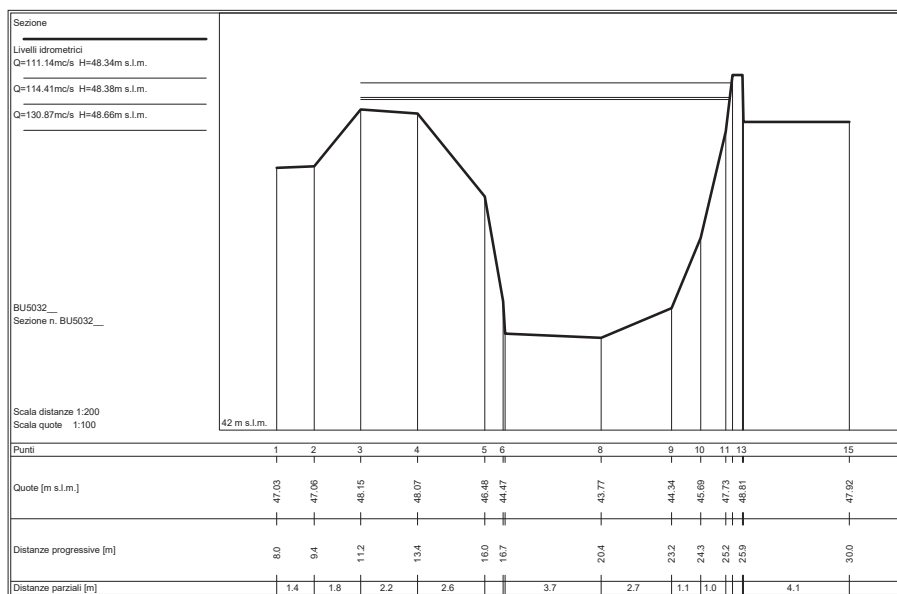
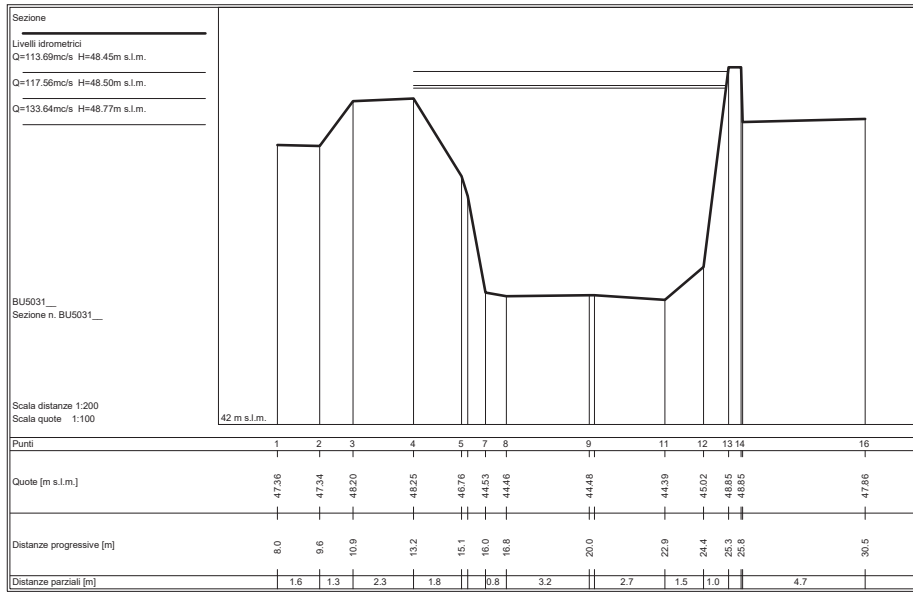

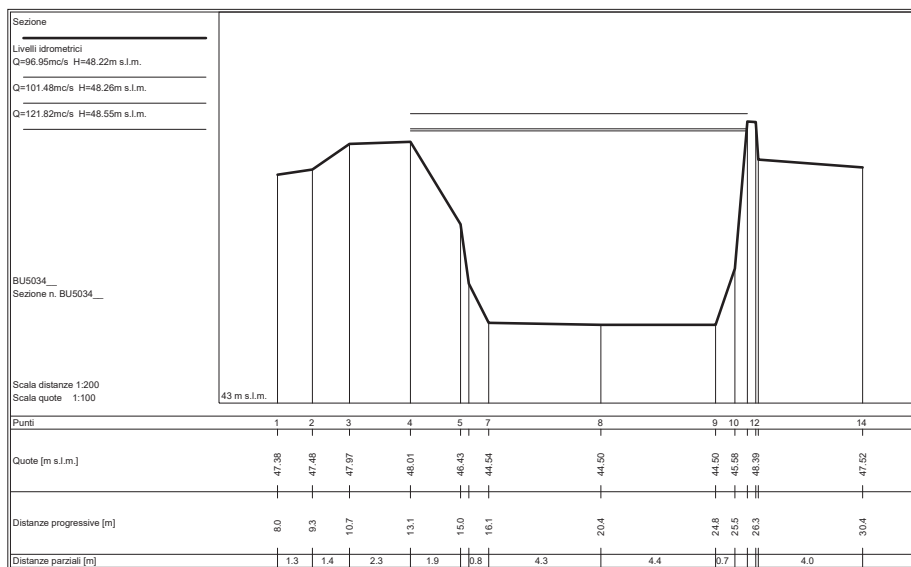
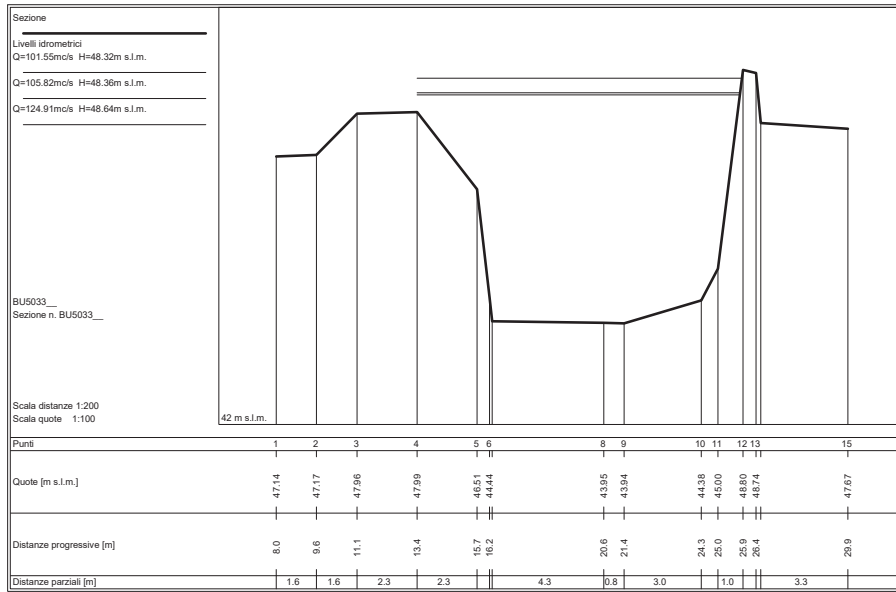

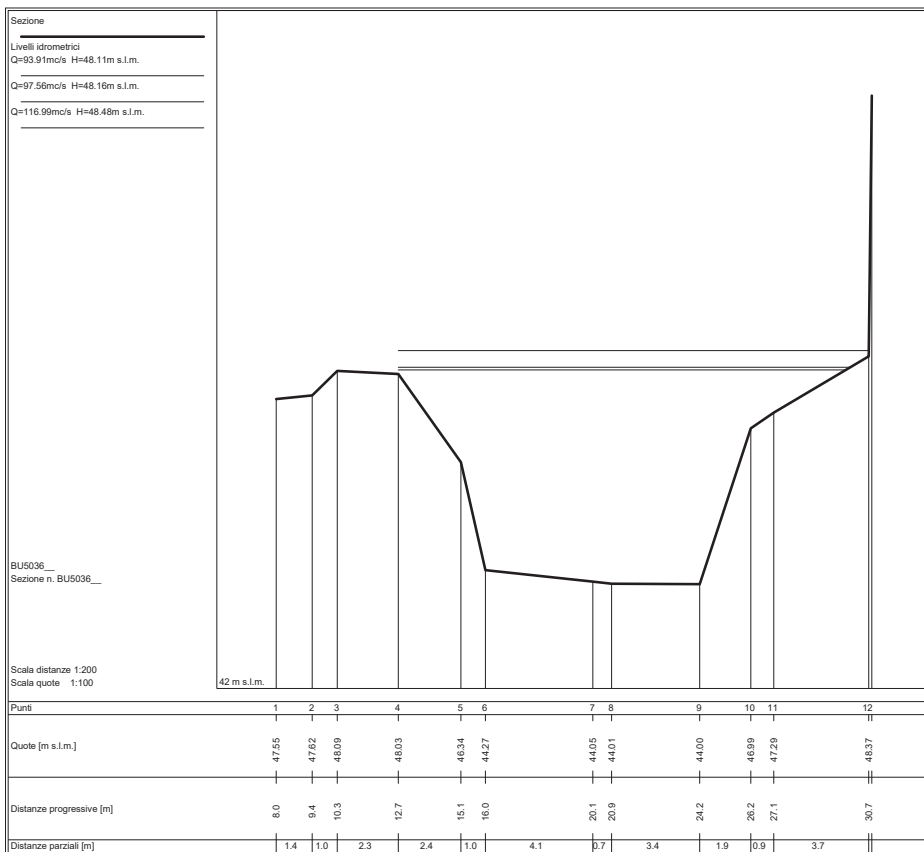
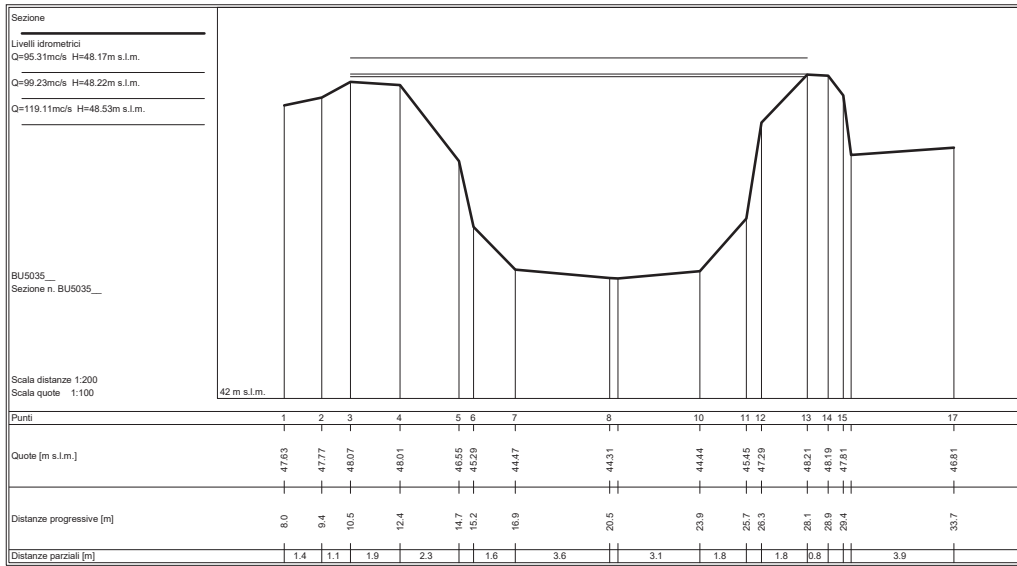

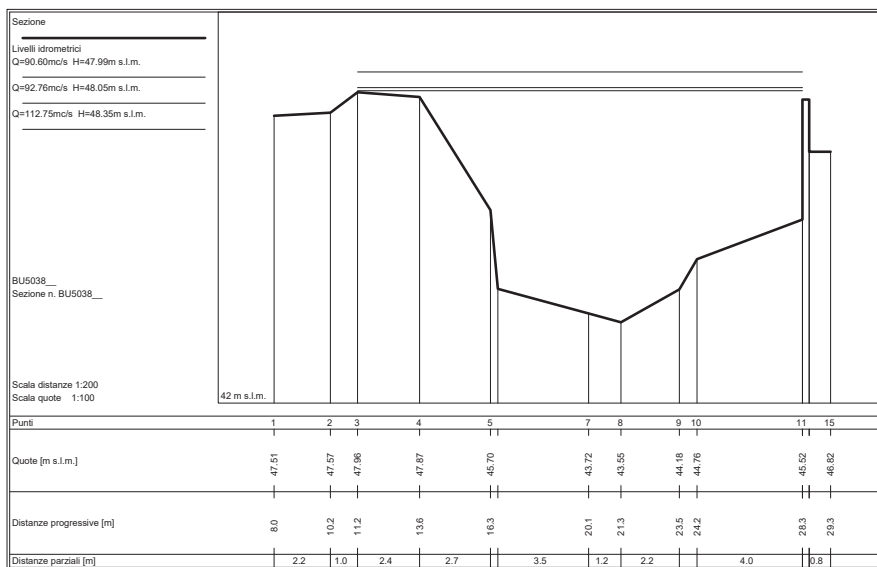
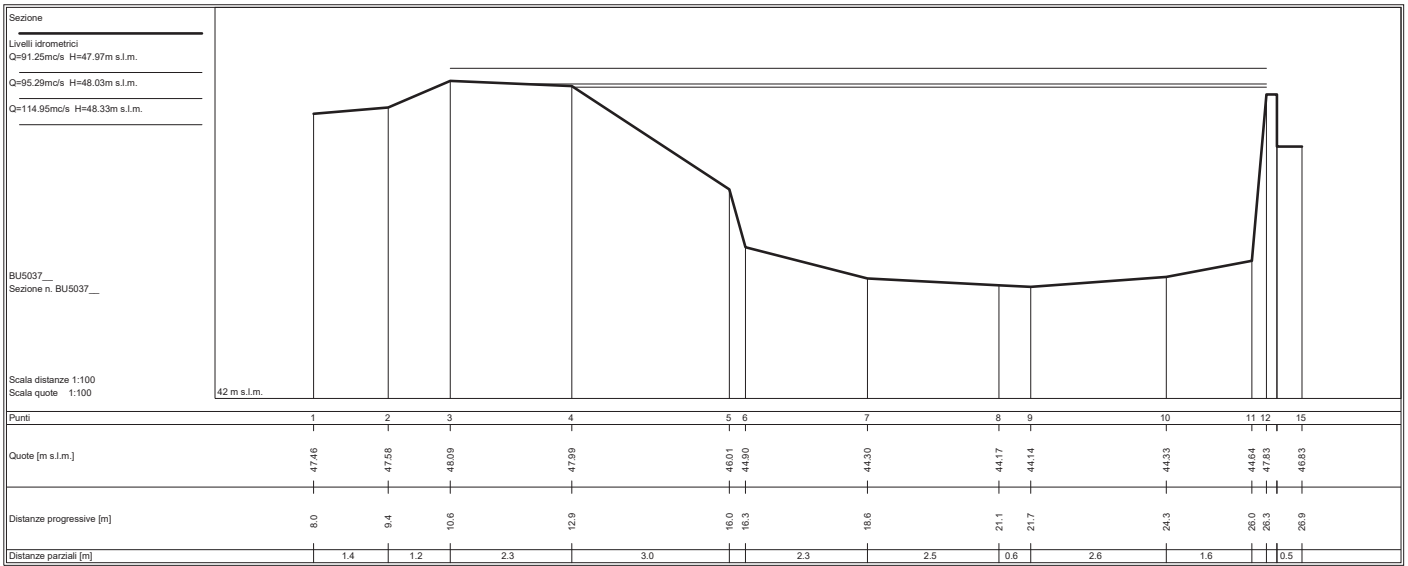

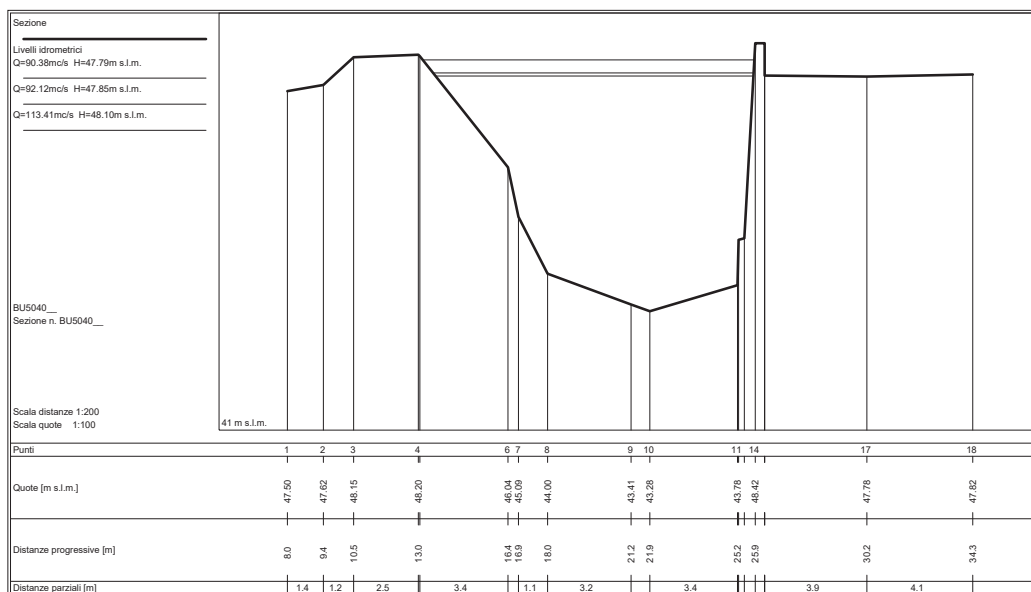
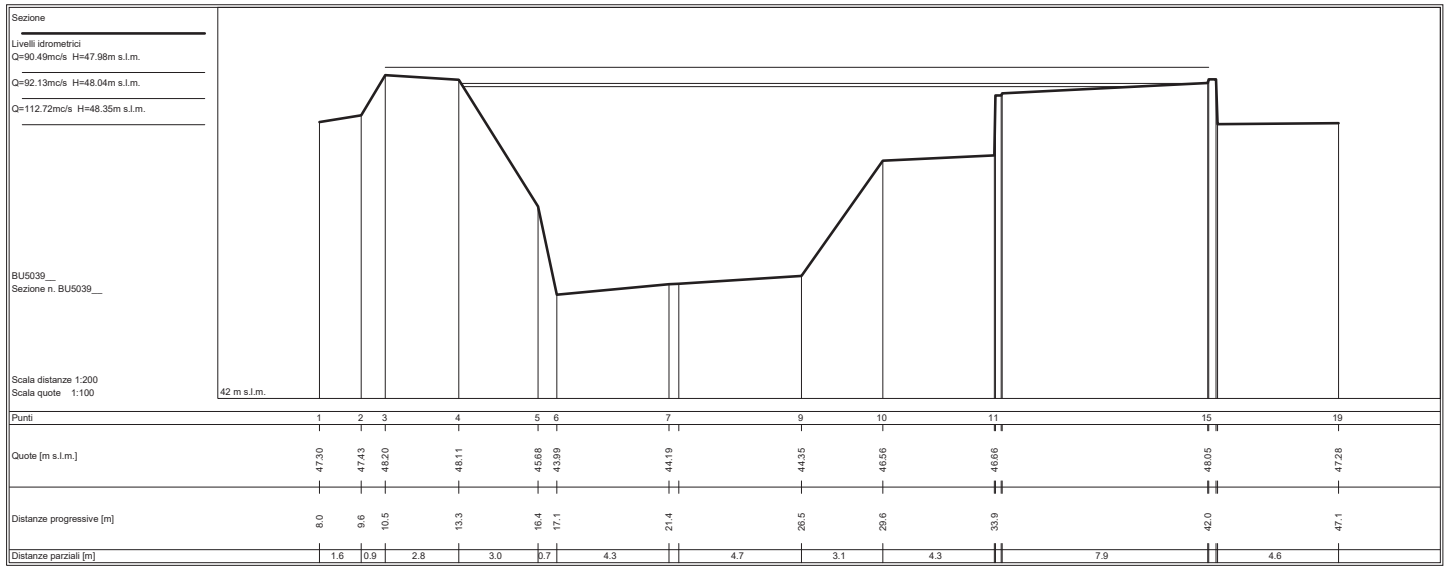

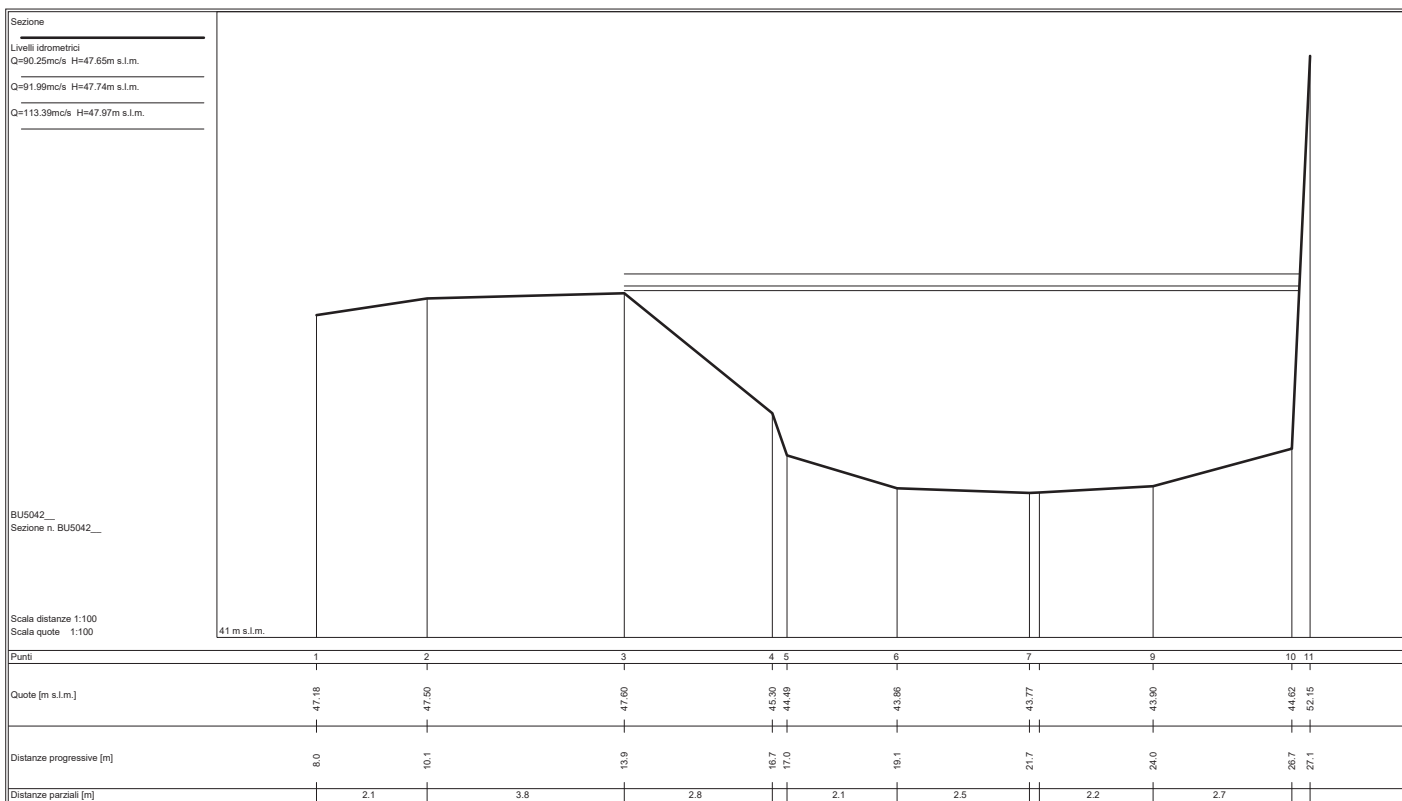
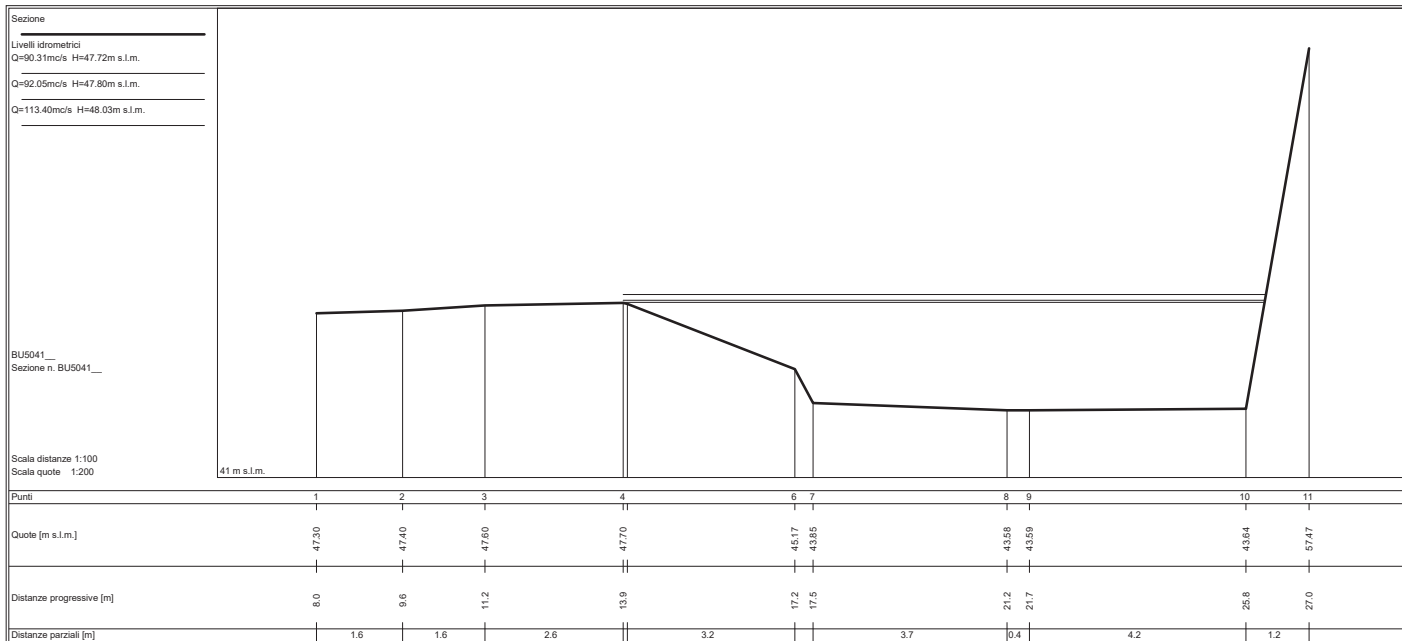

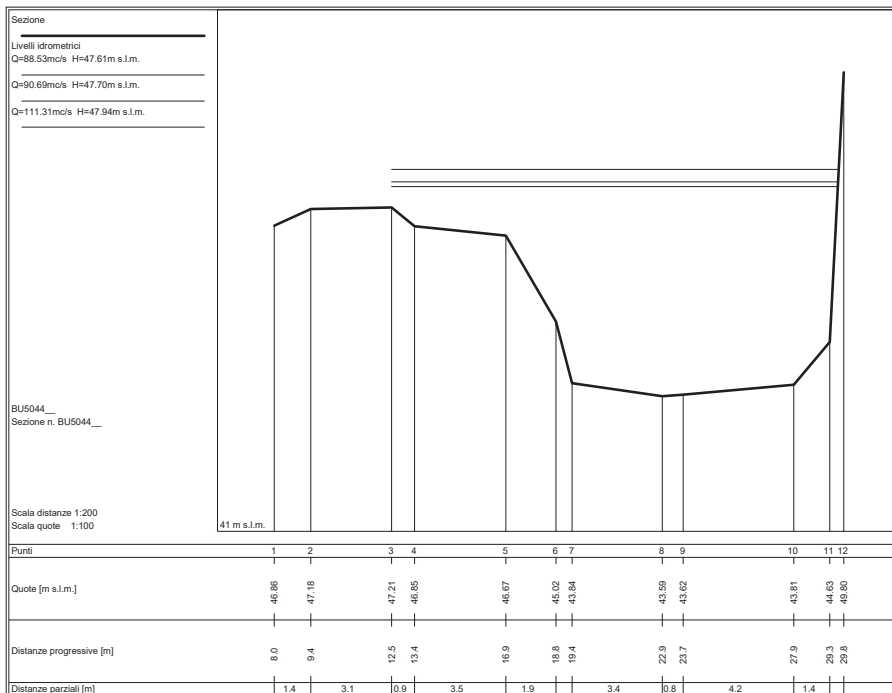
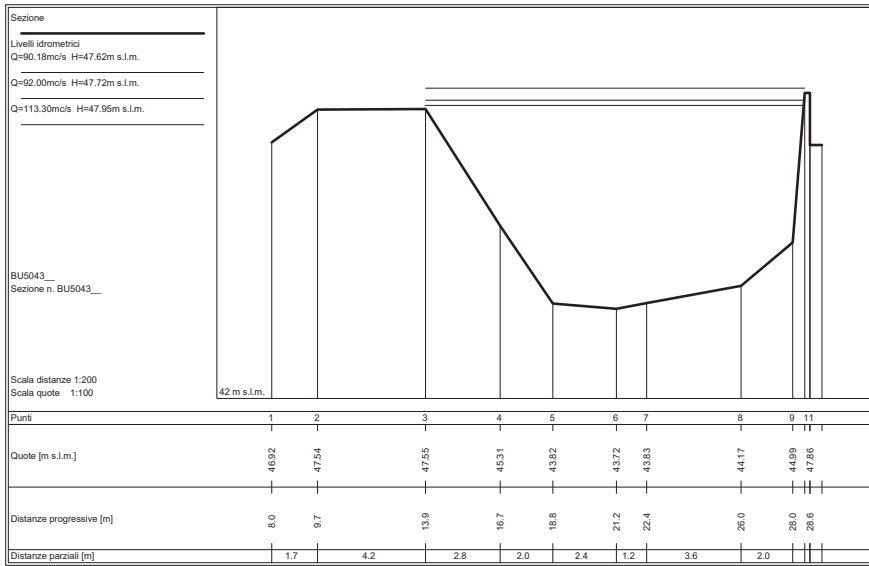



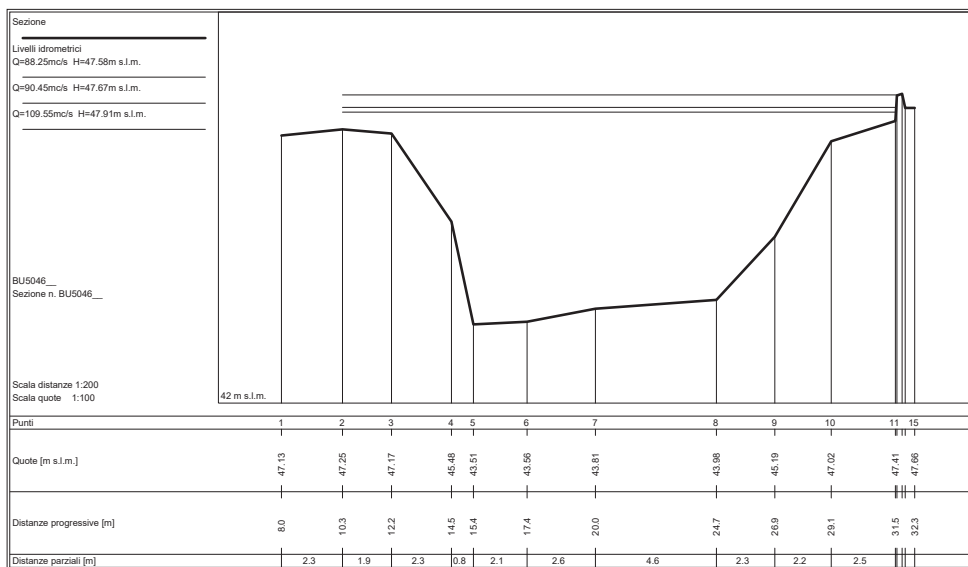
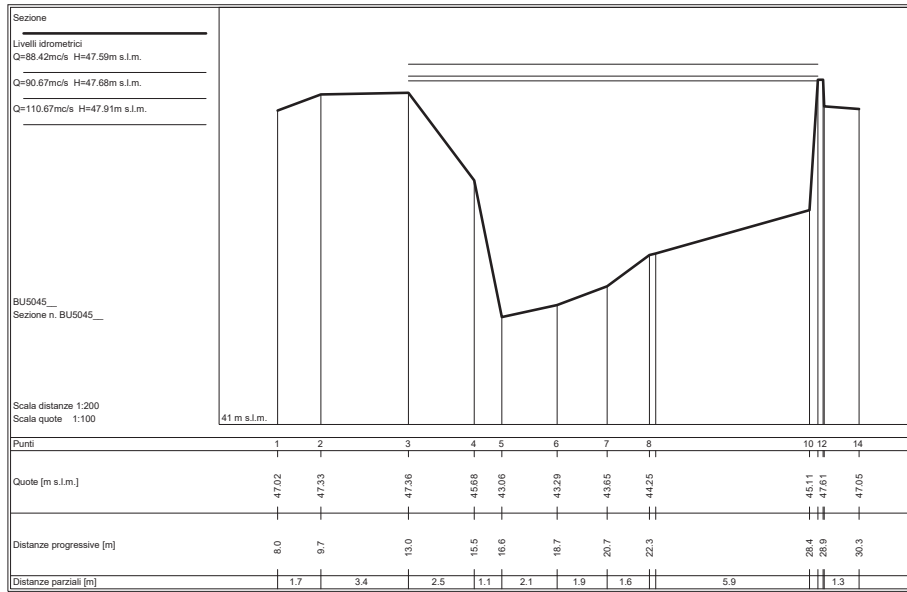

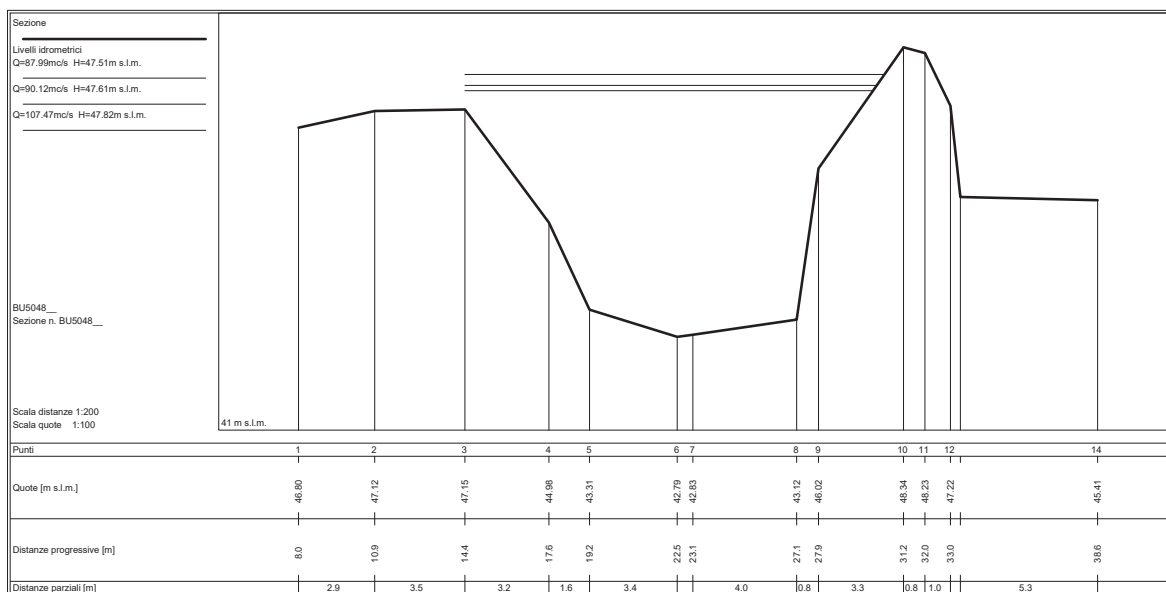
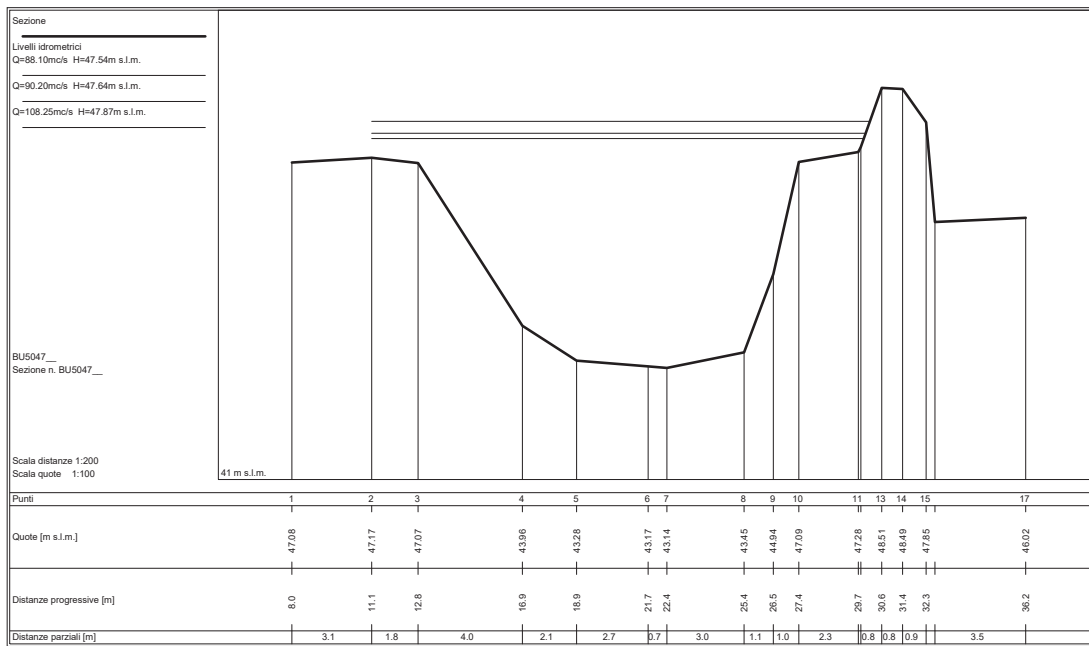

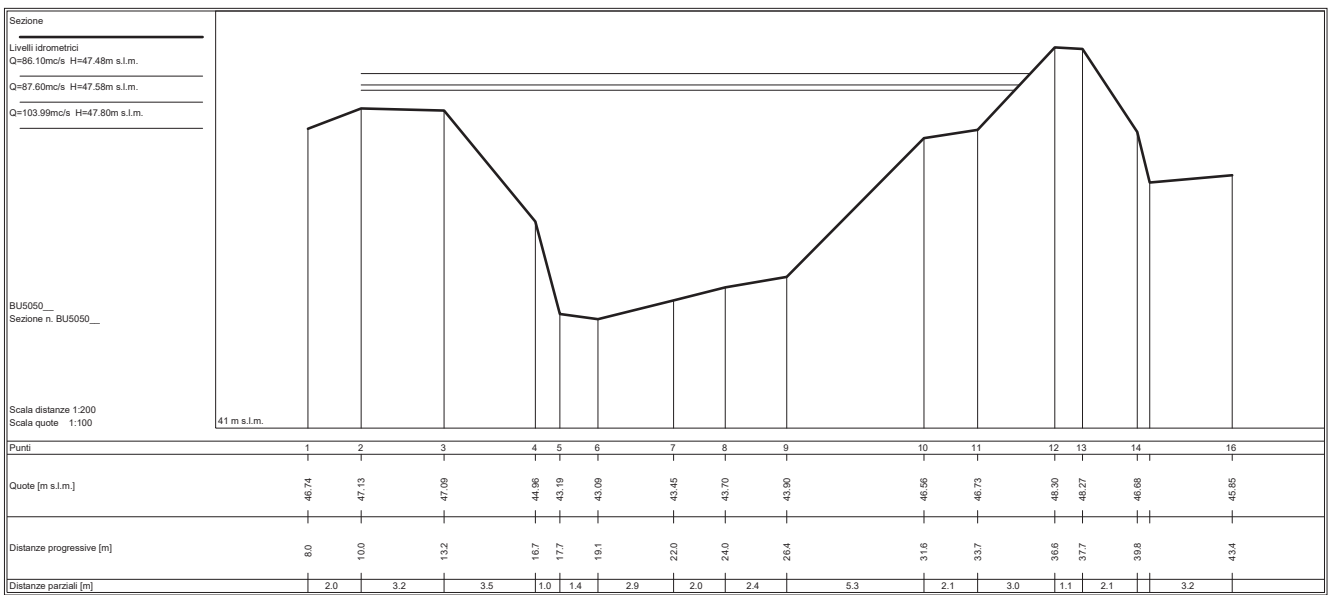
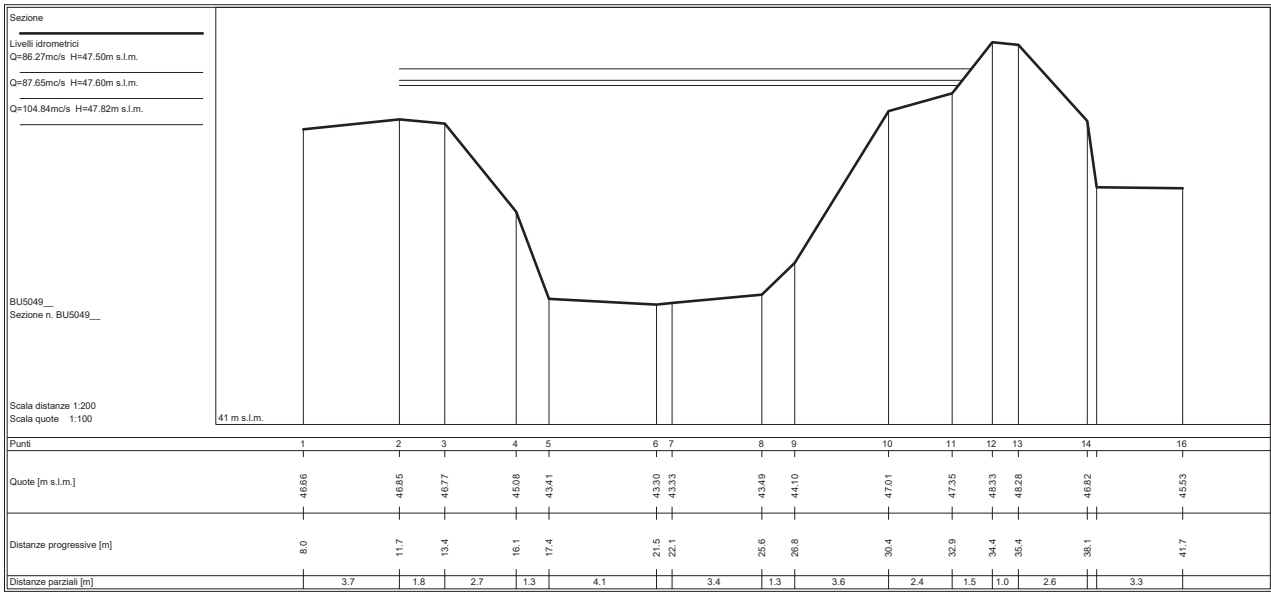

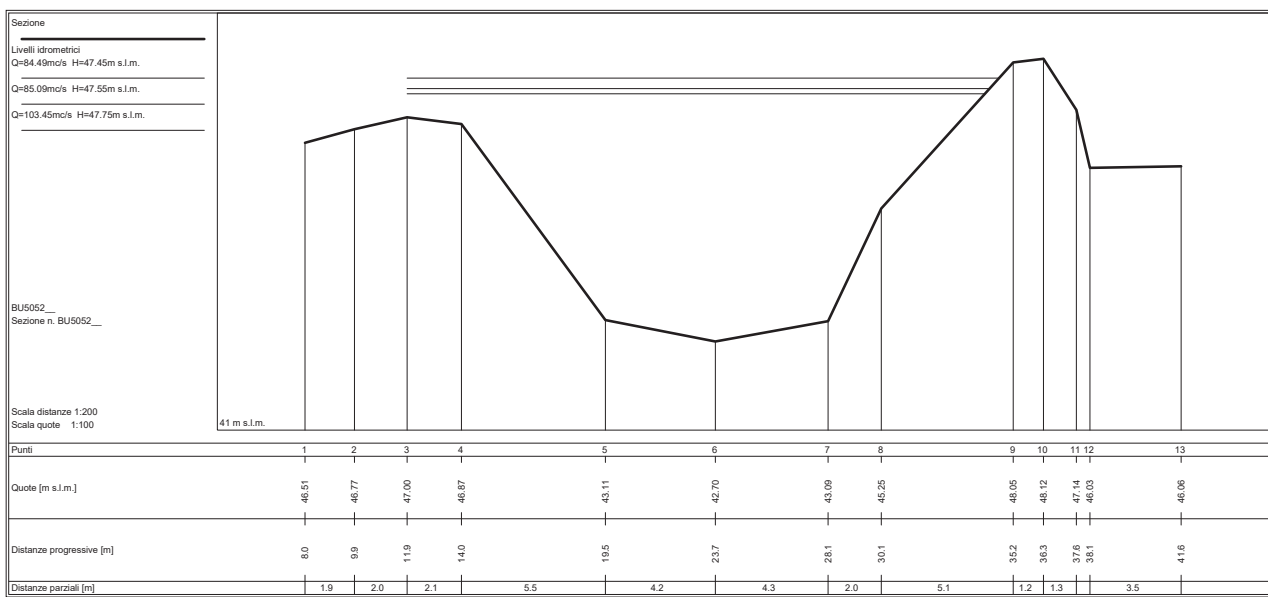
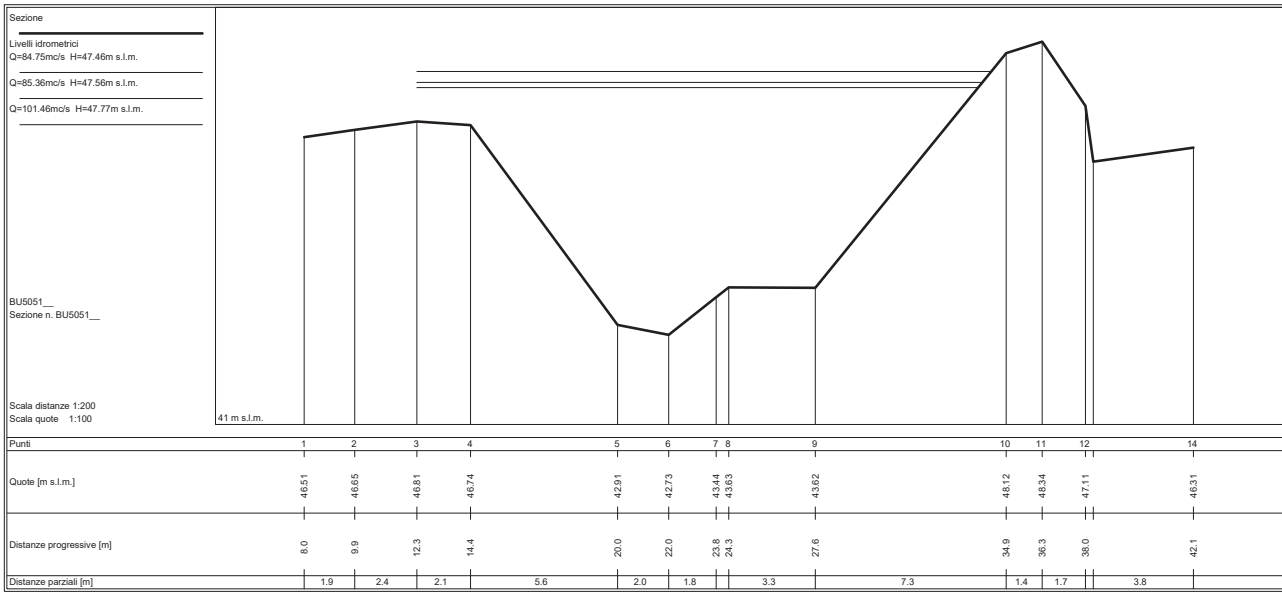

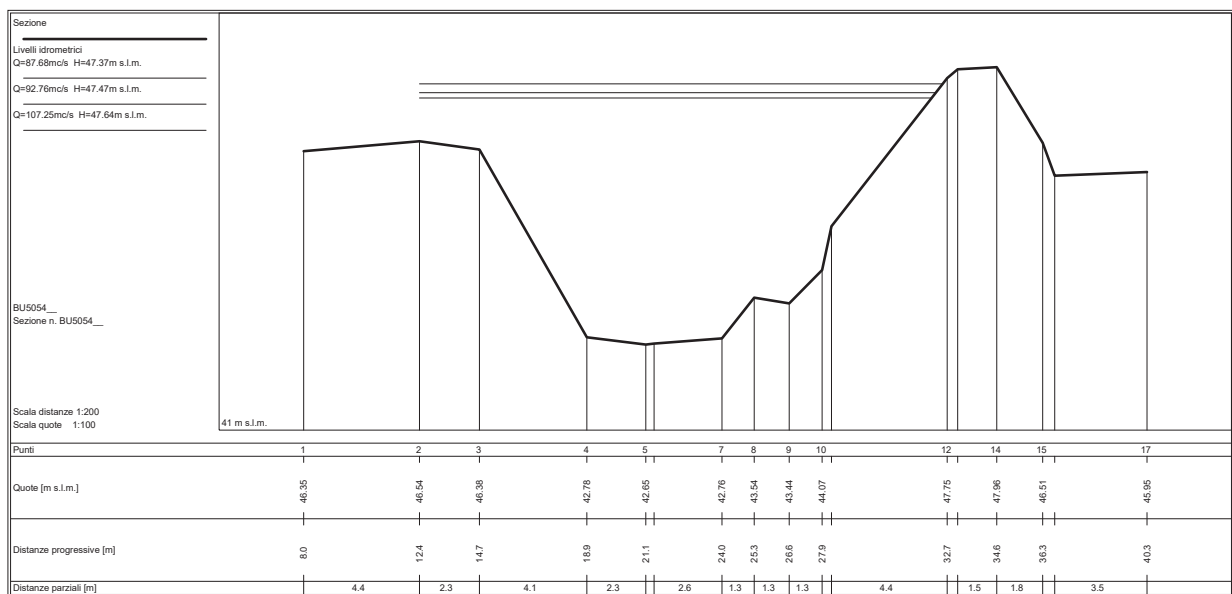
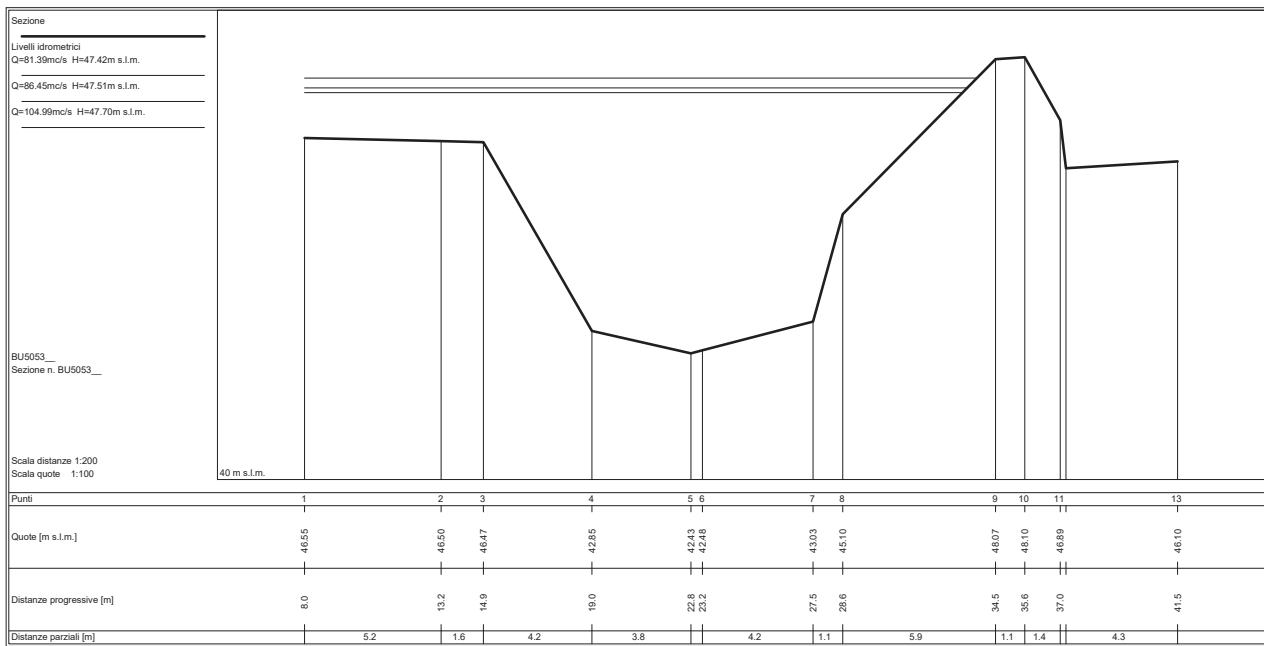

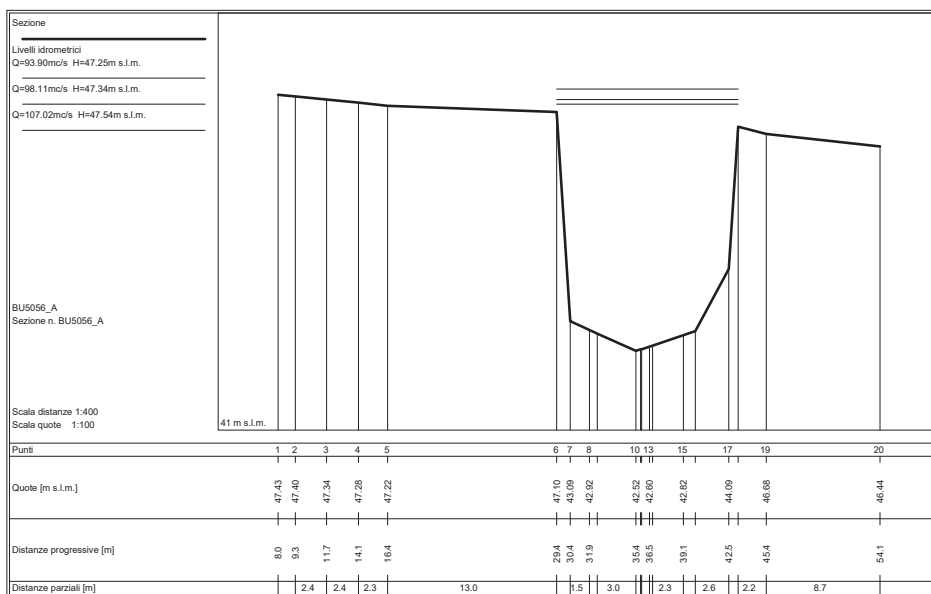
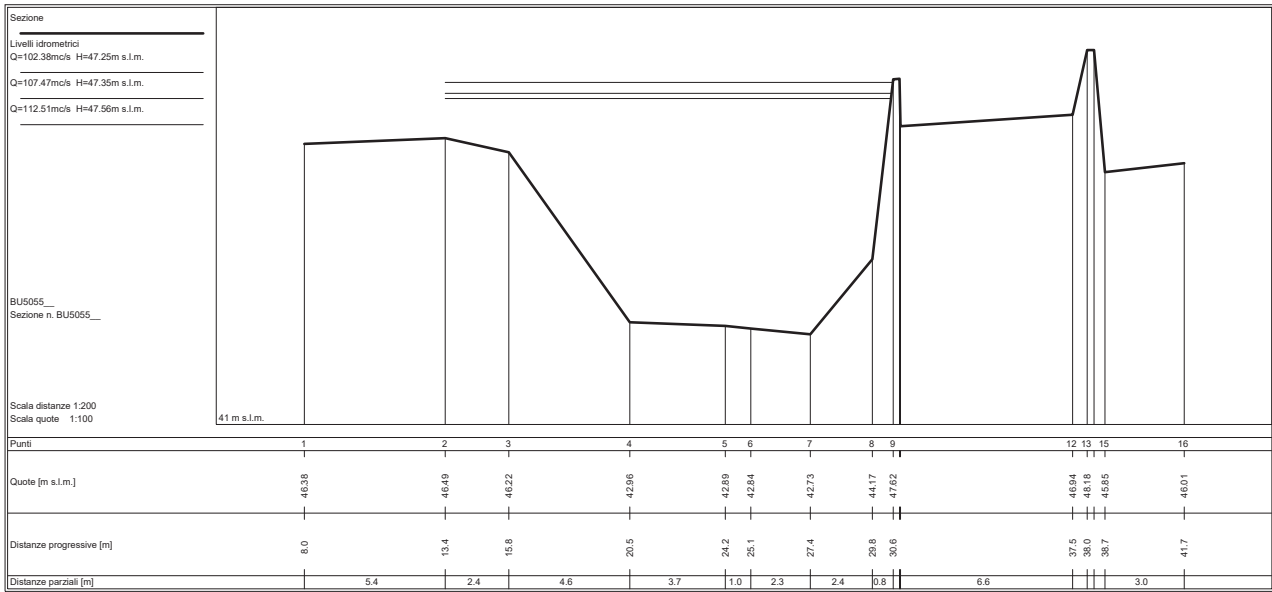

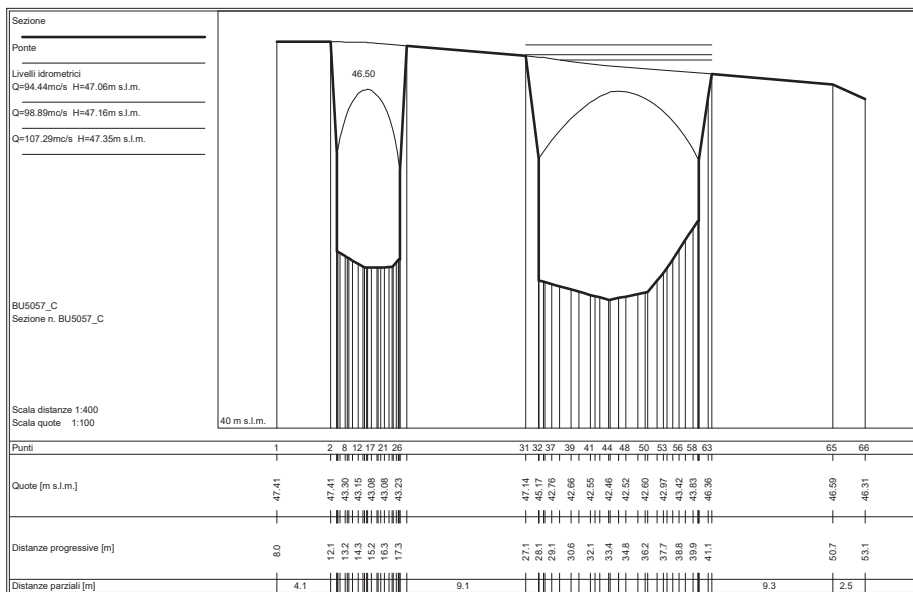
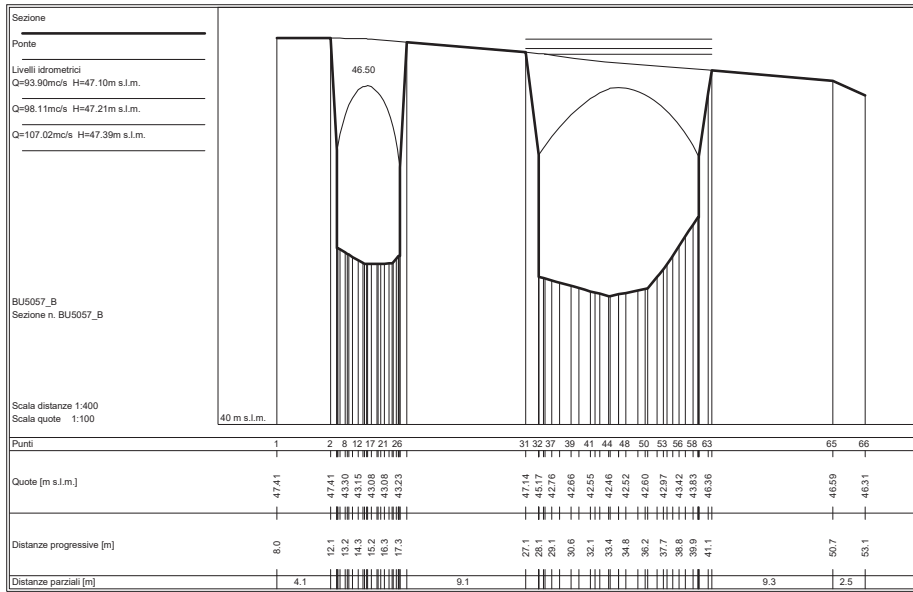

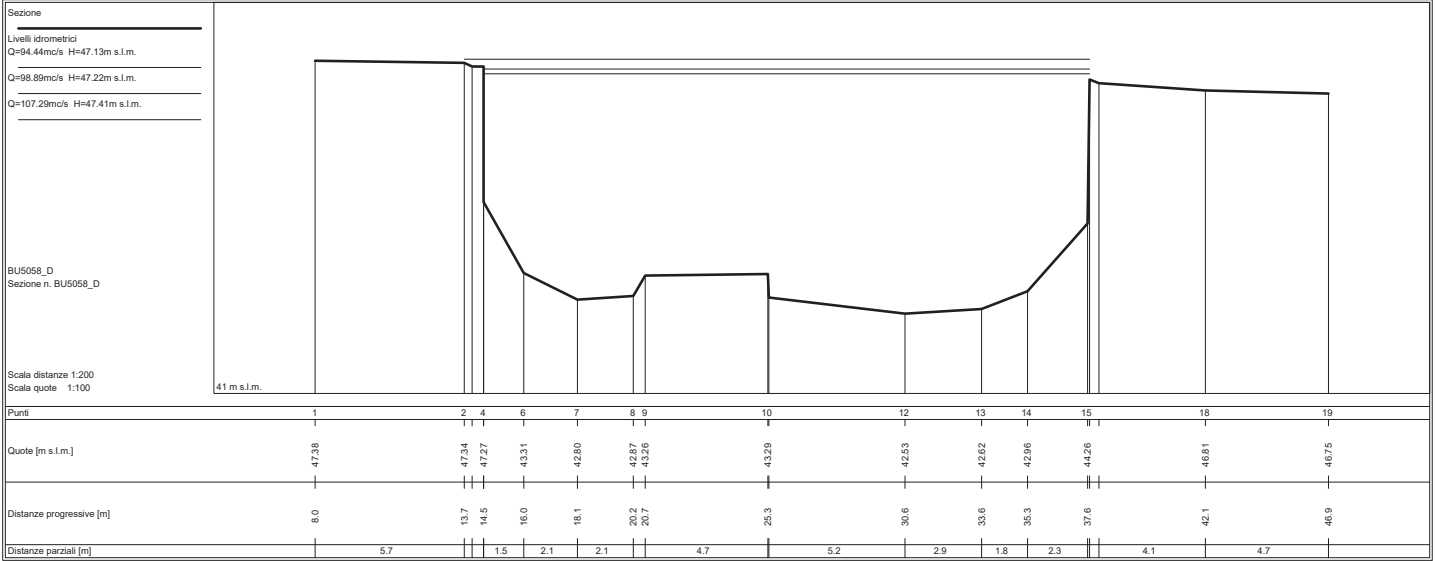



SEZIONI FLUVIALI  
TORRENTE BURE - TRATTO 2

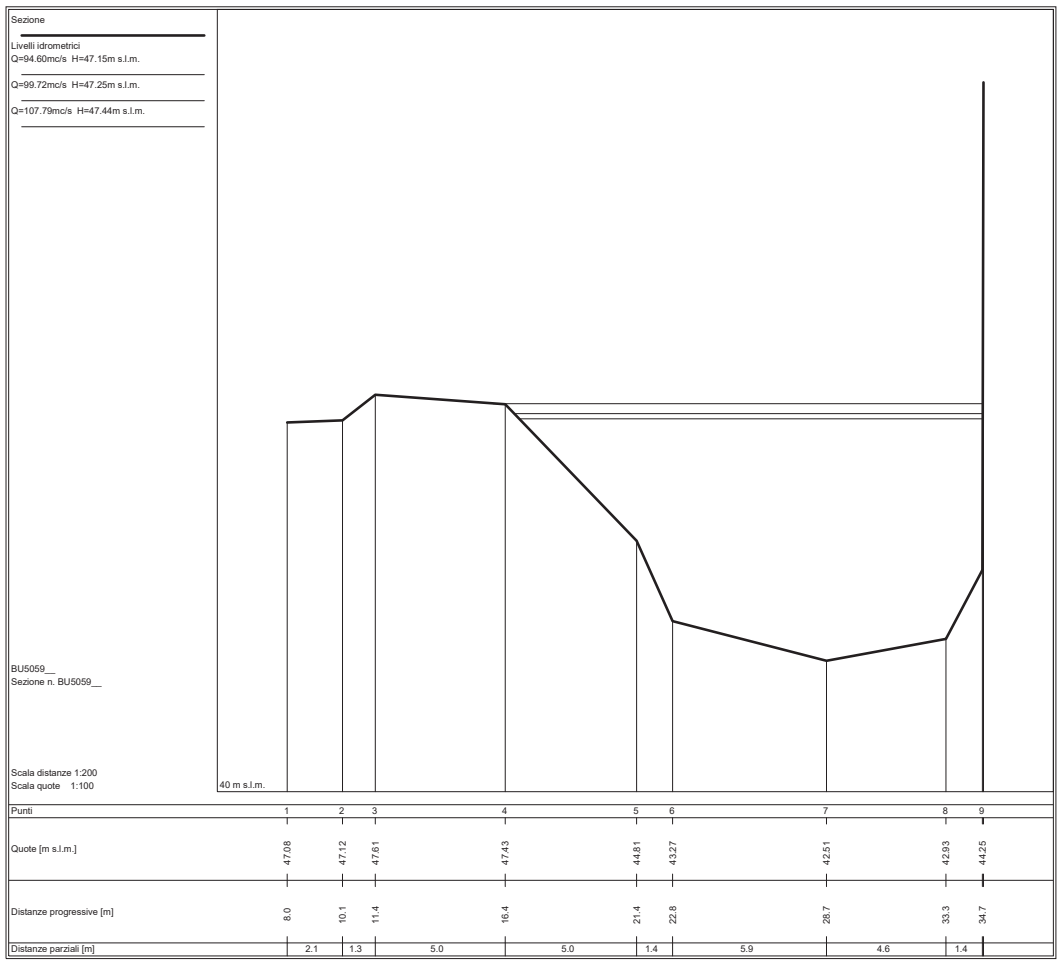
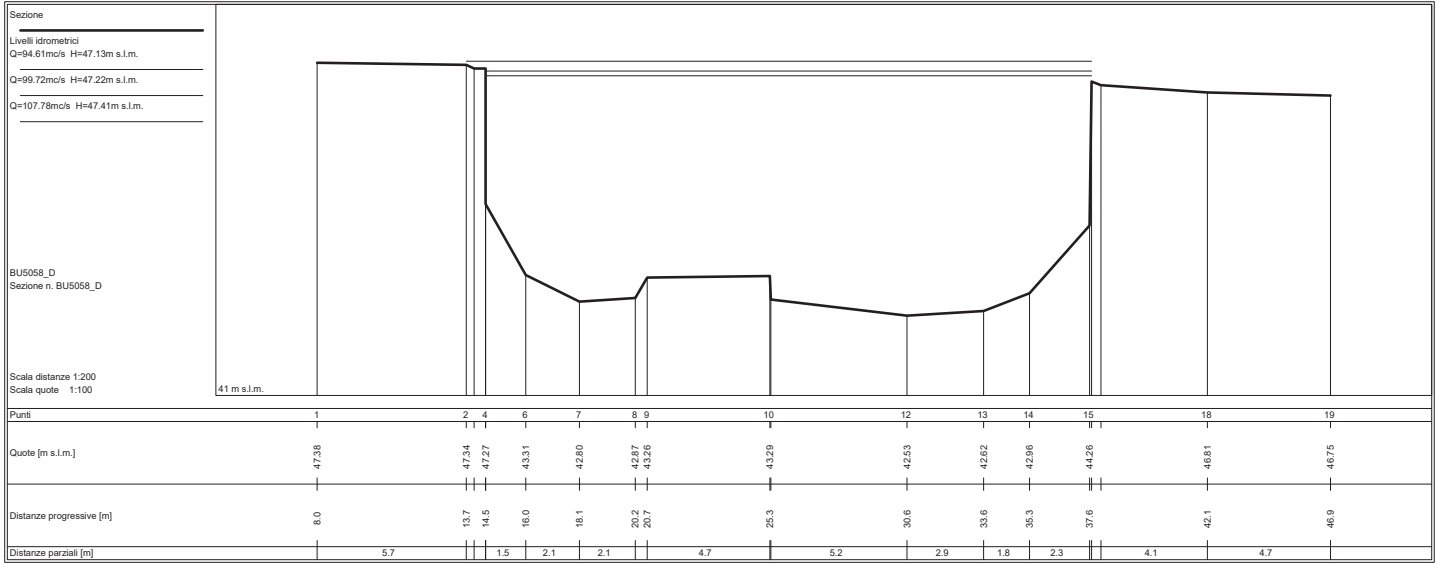

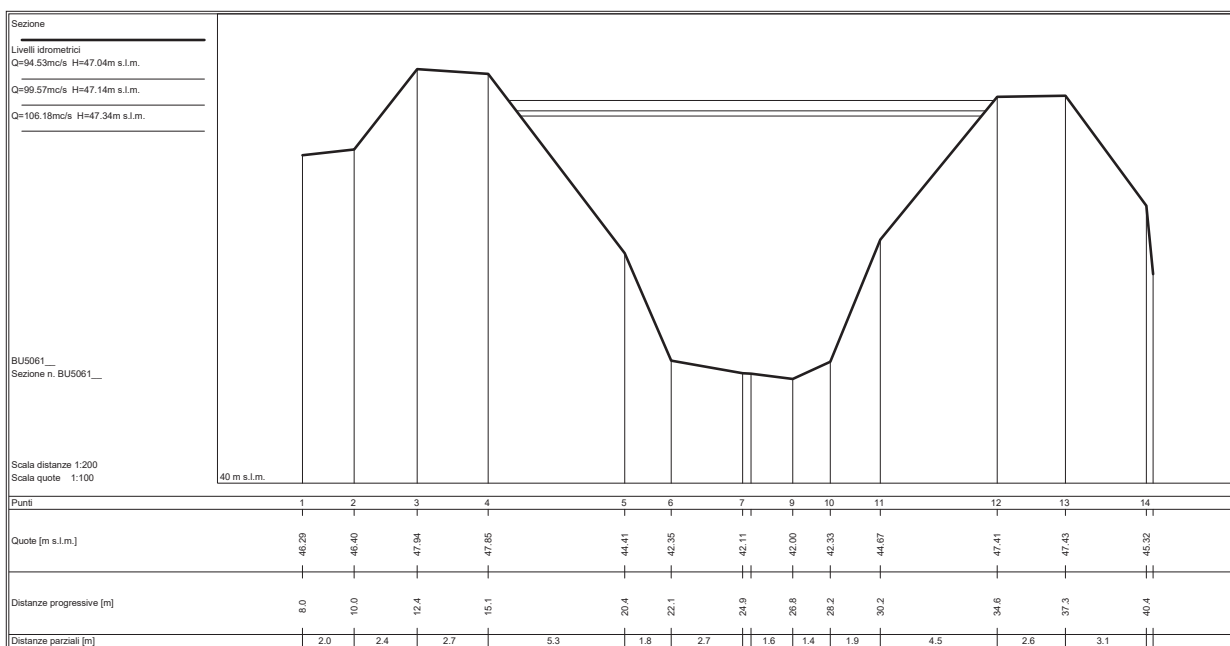
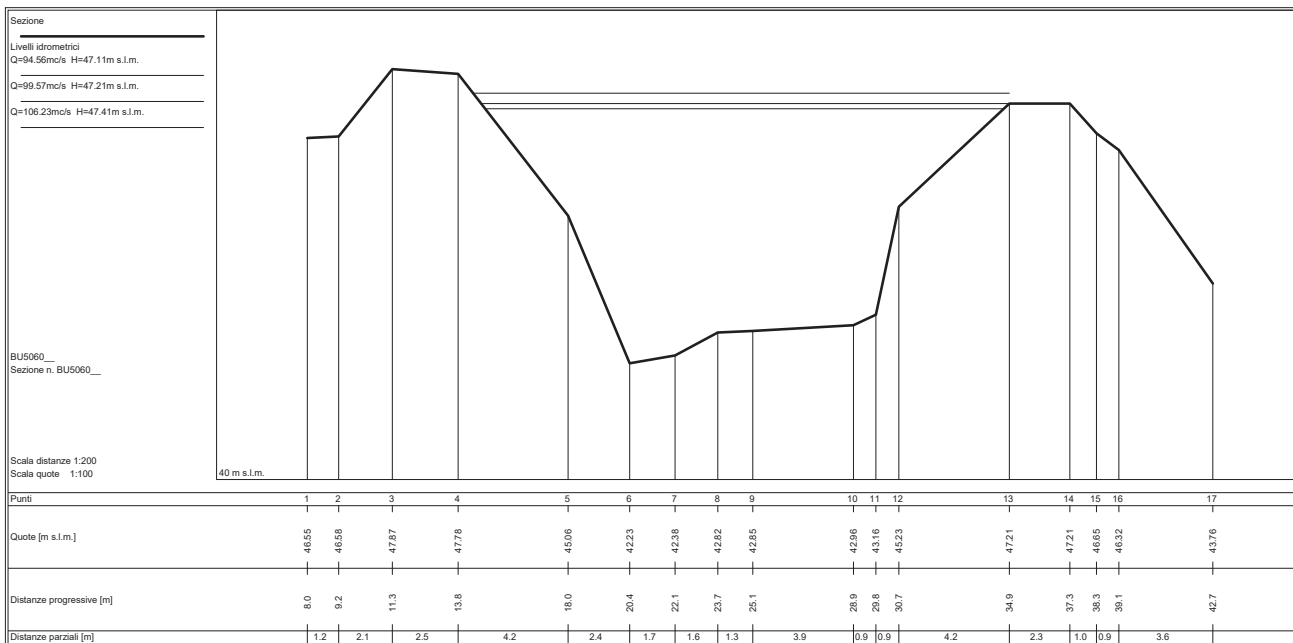

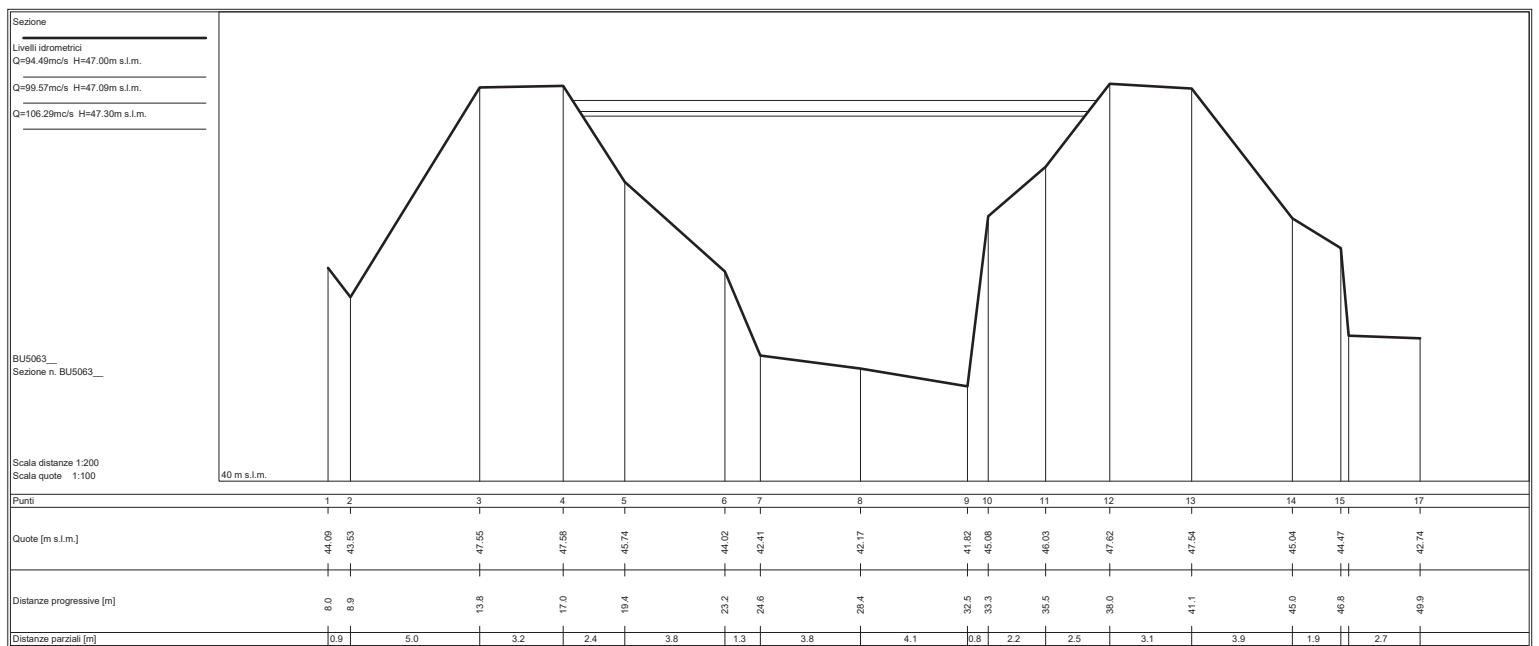
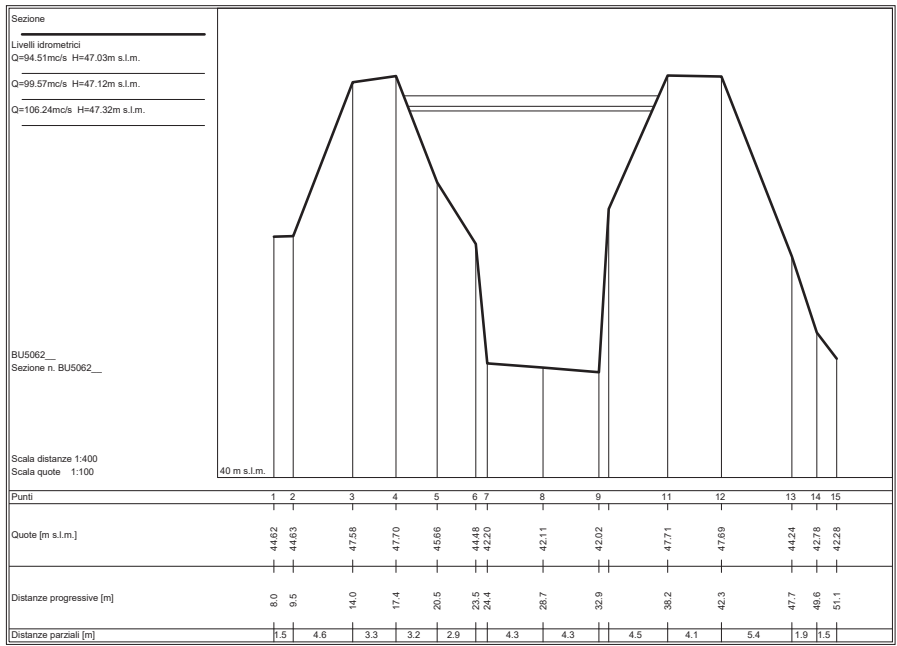

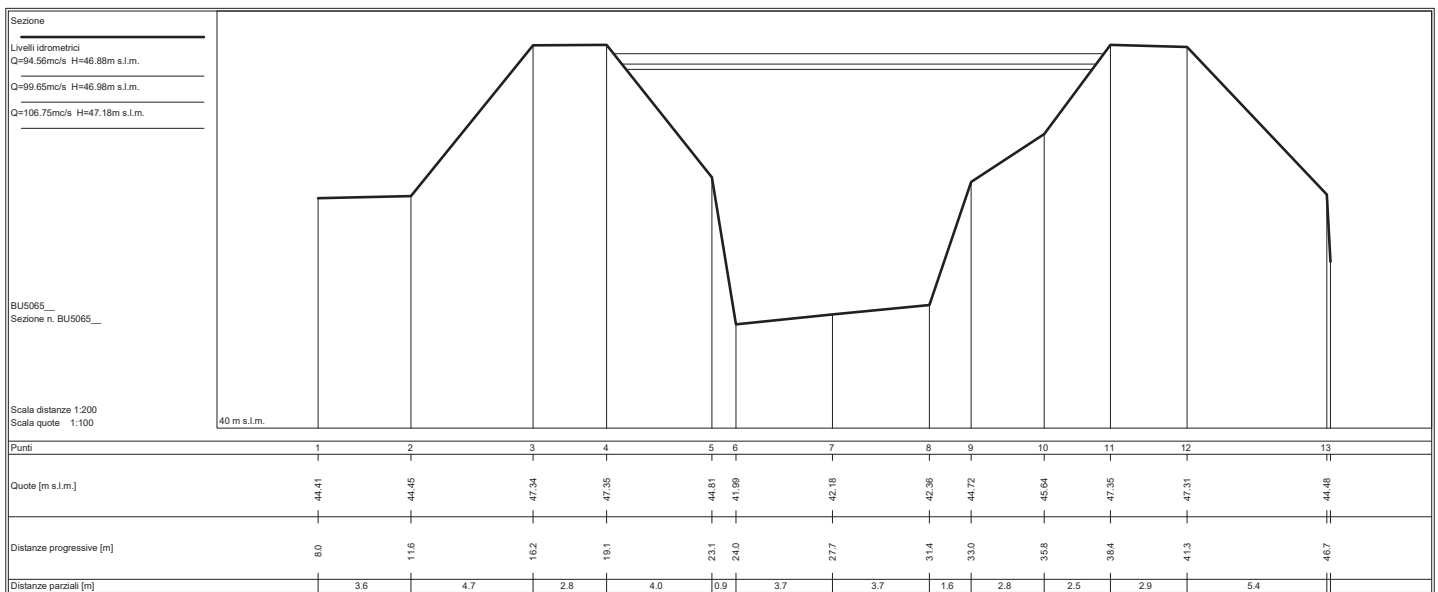
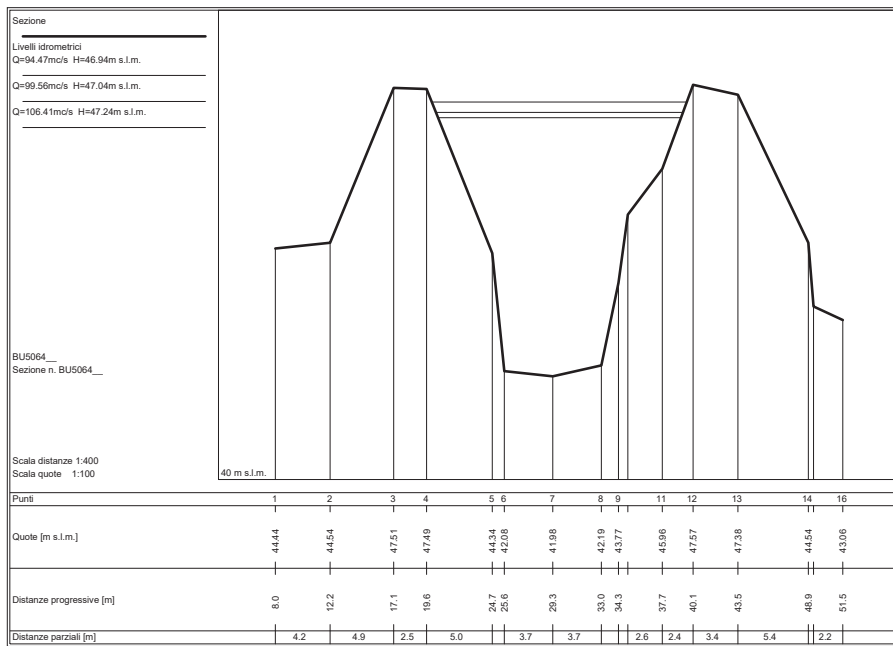

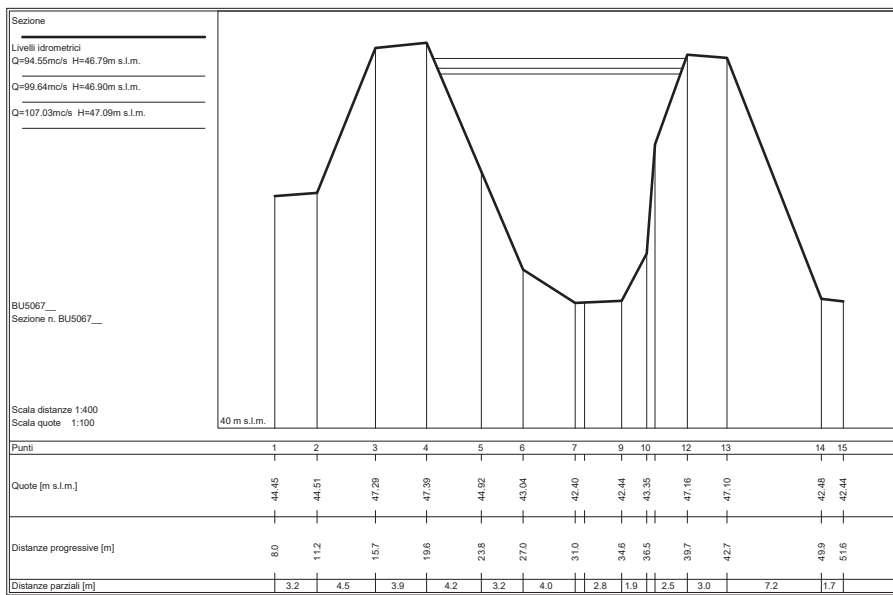
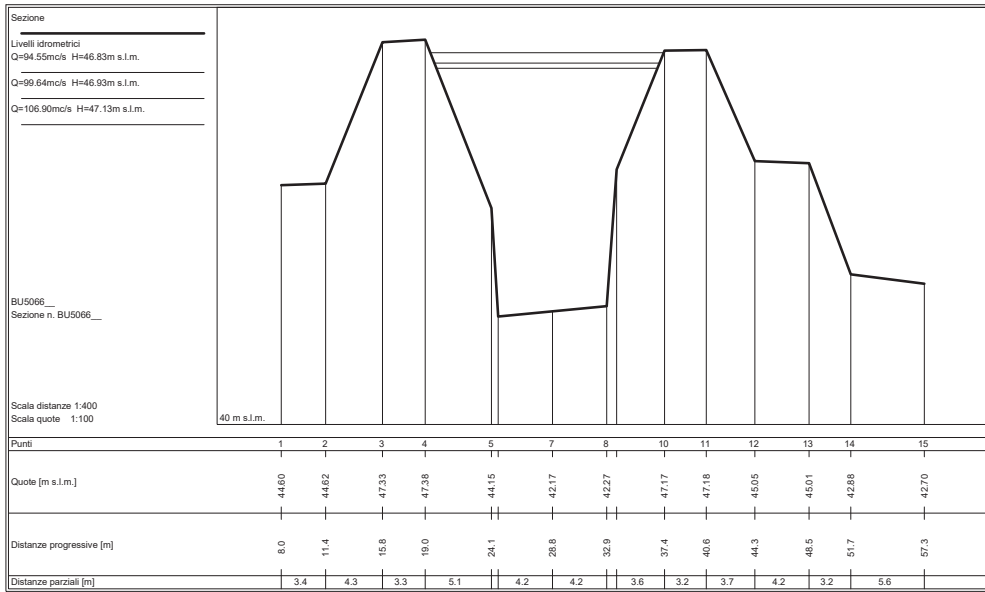

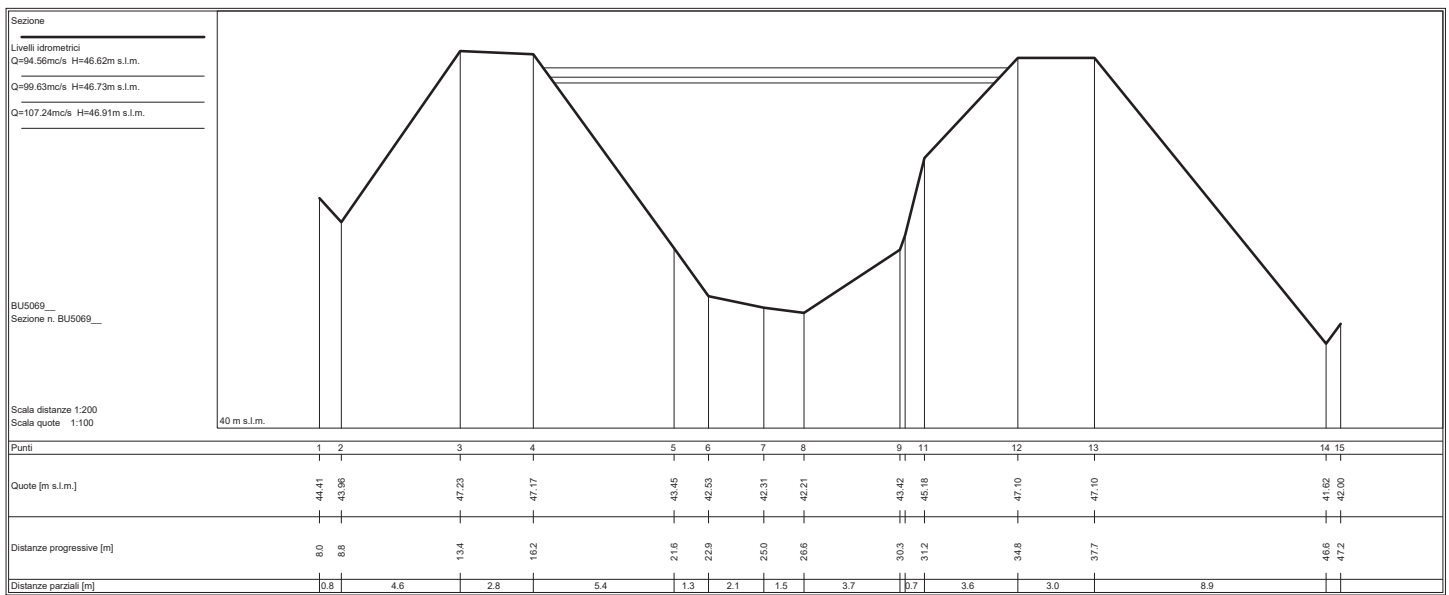
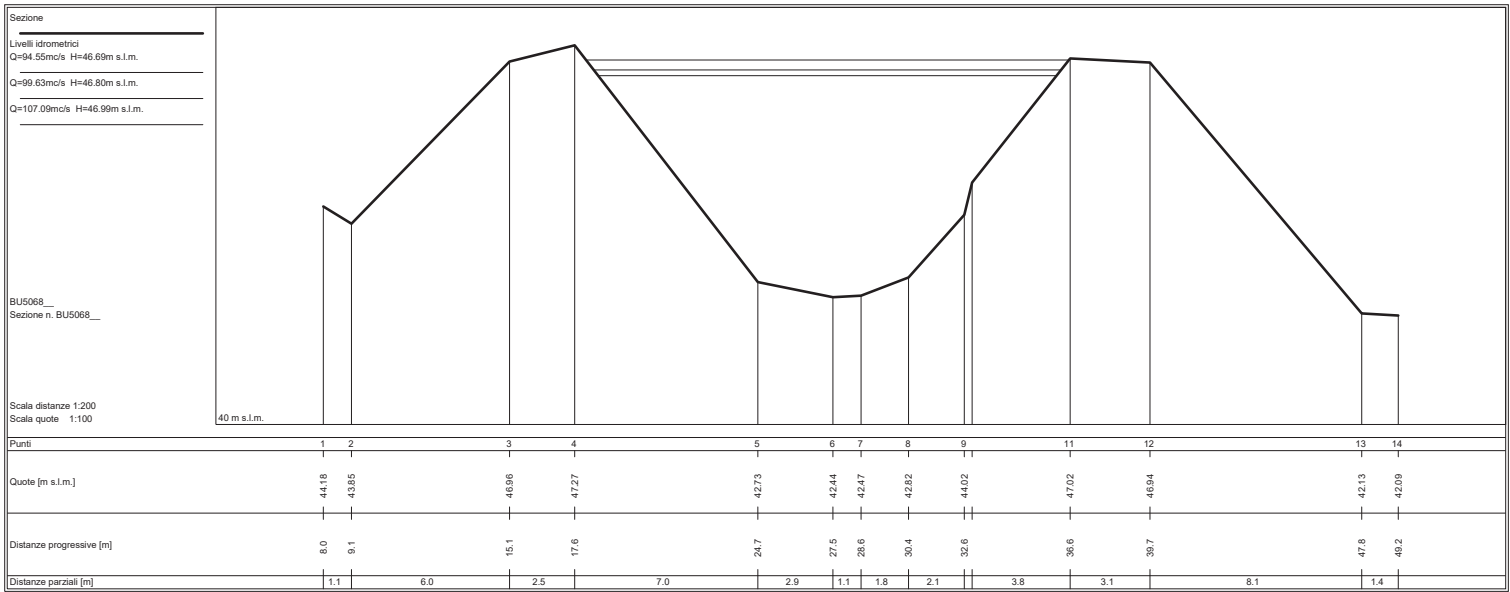

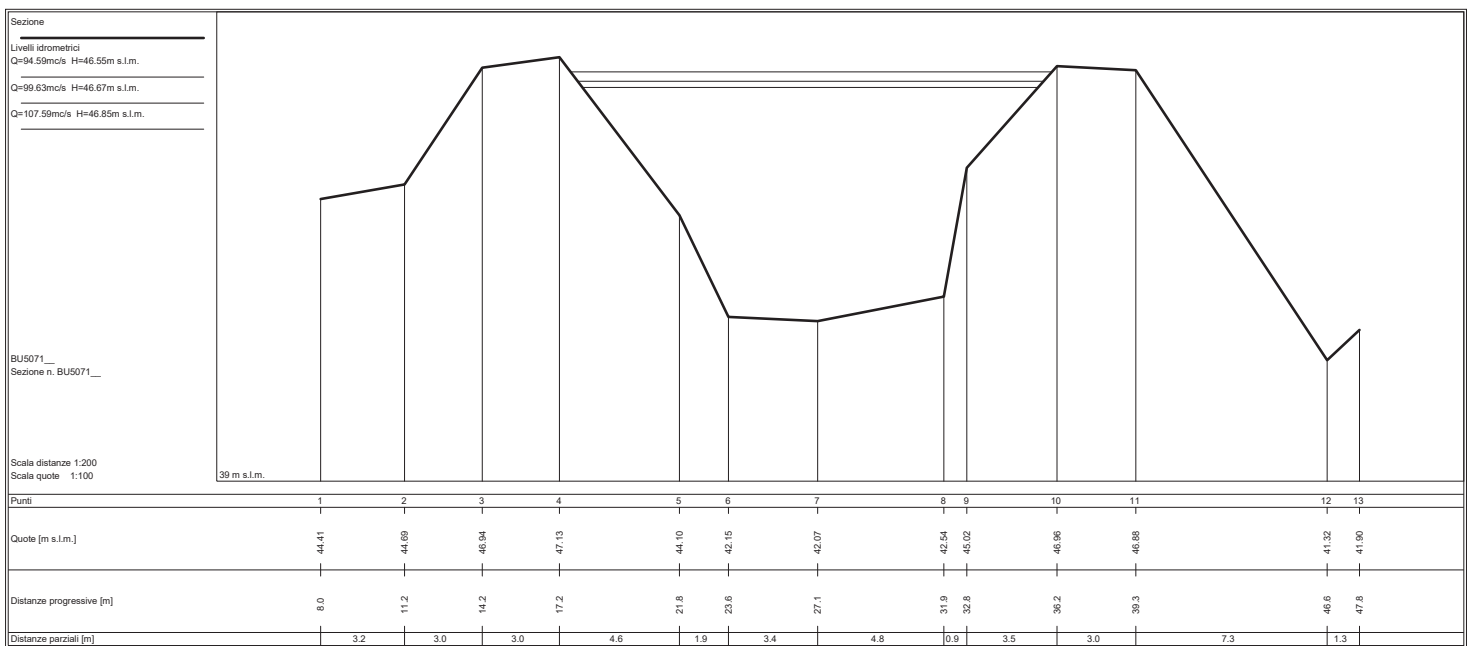
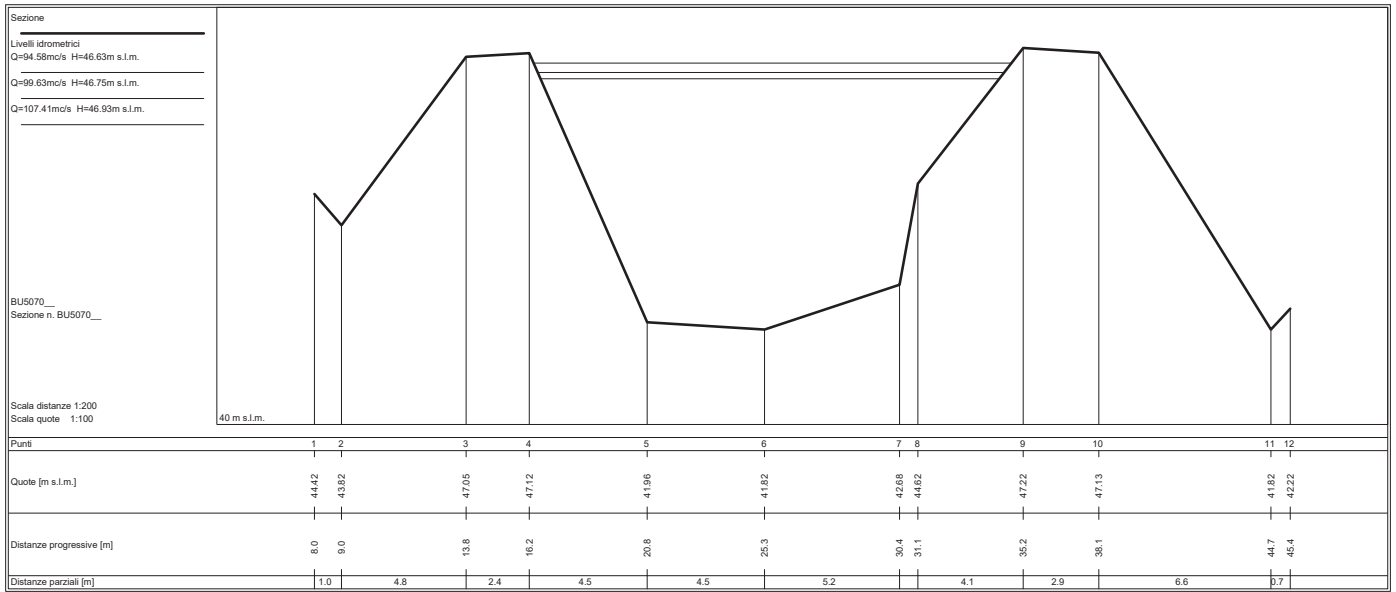



SEZIONI FLUVIALI  
TORRENTE BURE - TRATTO 3

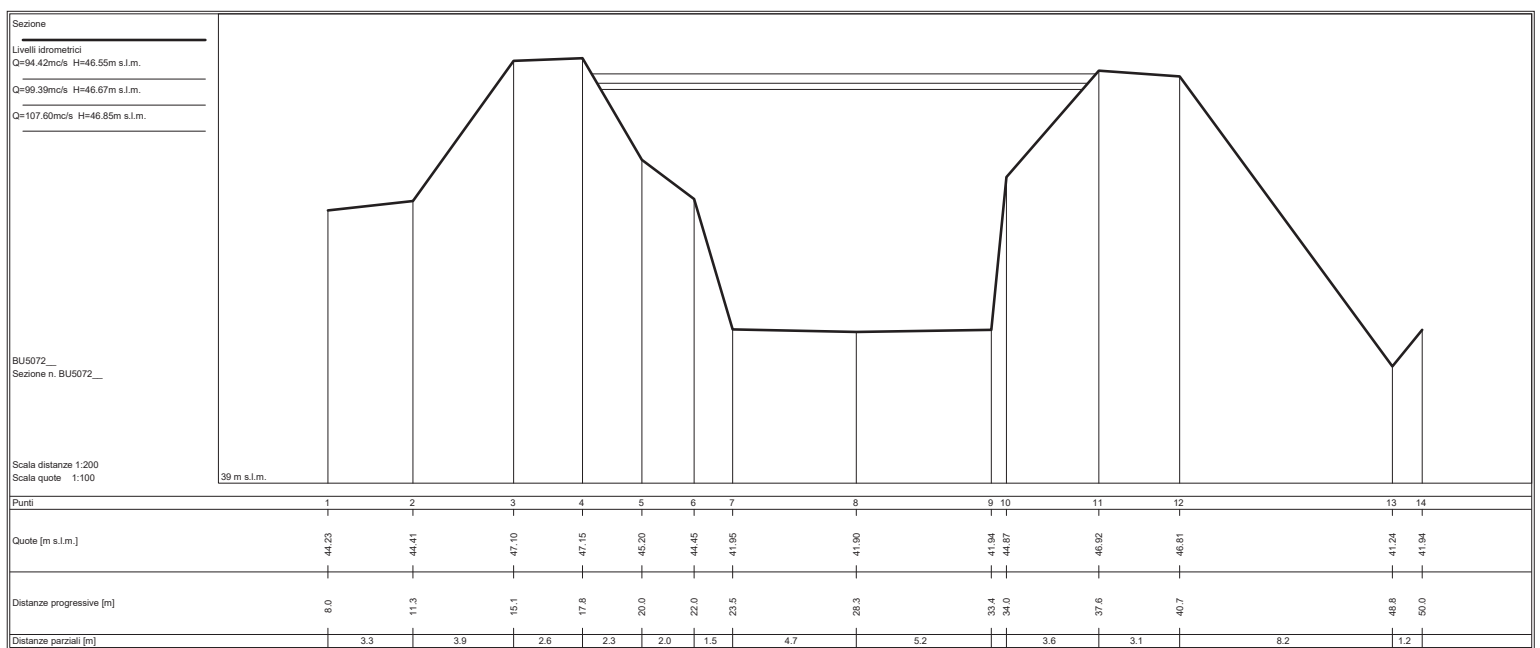
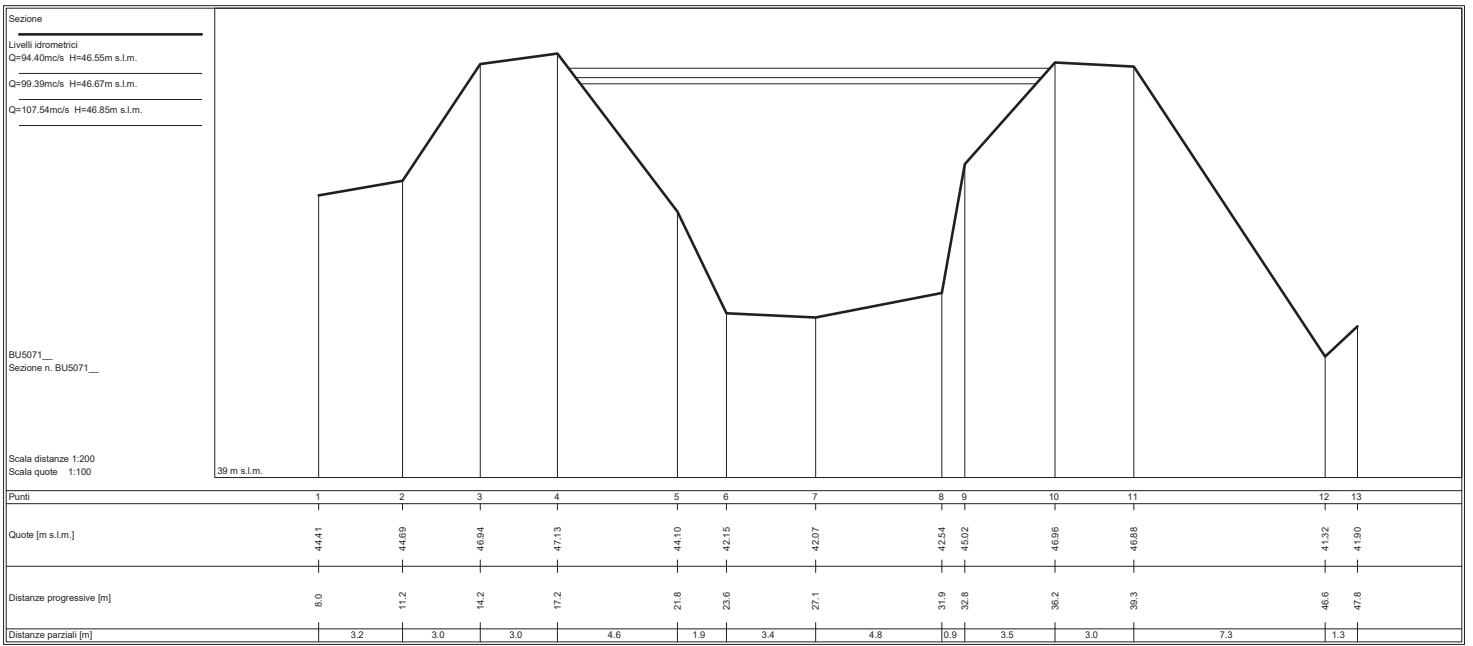

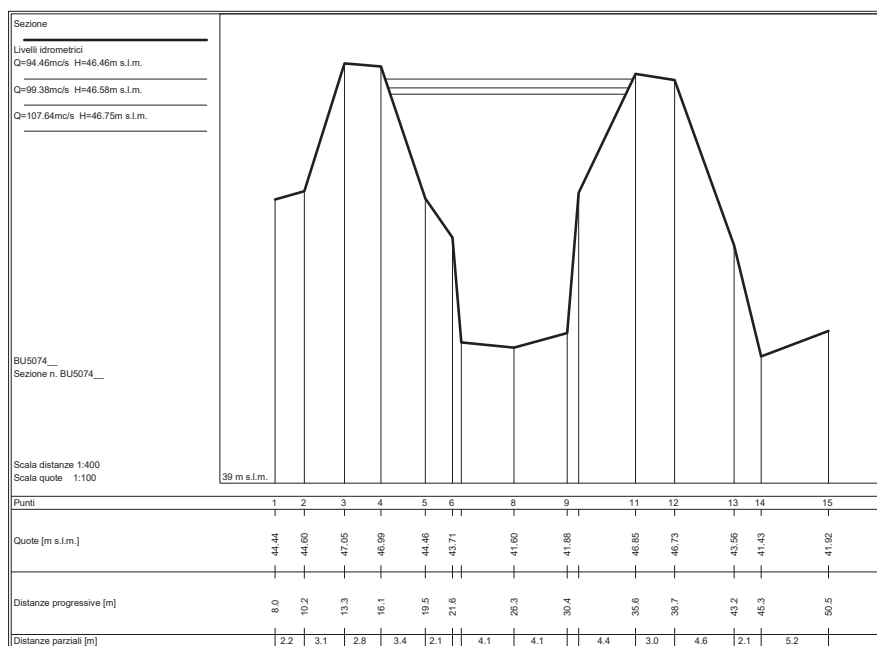
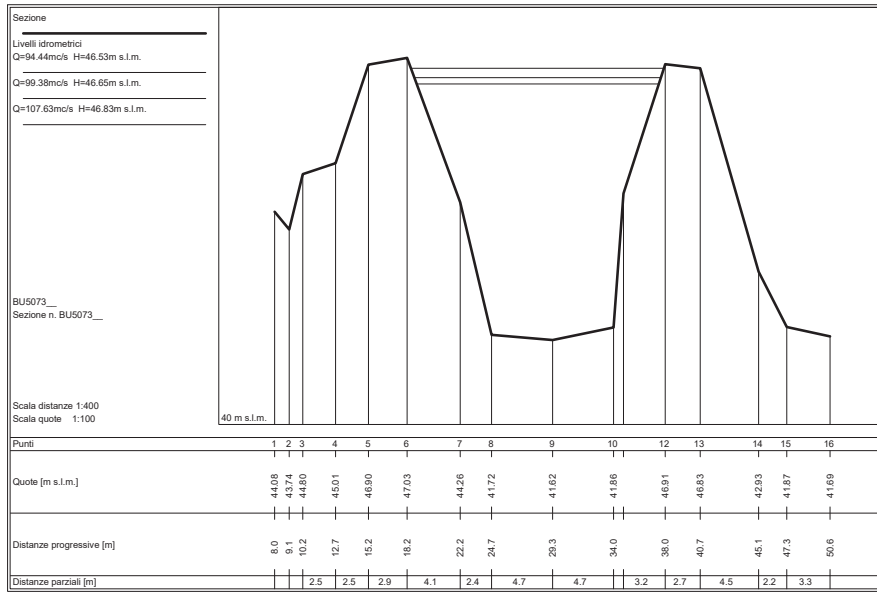

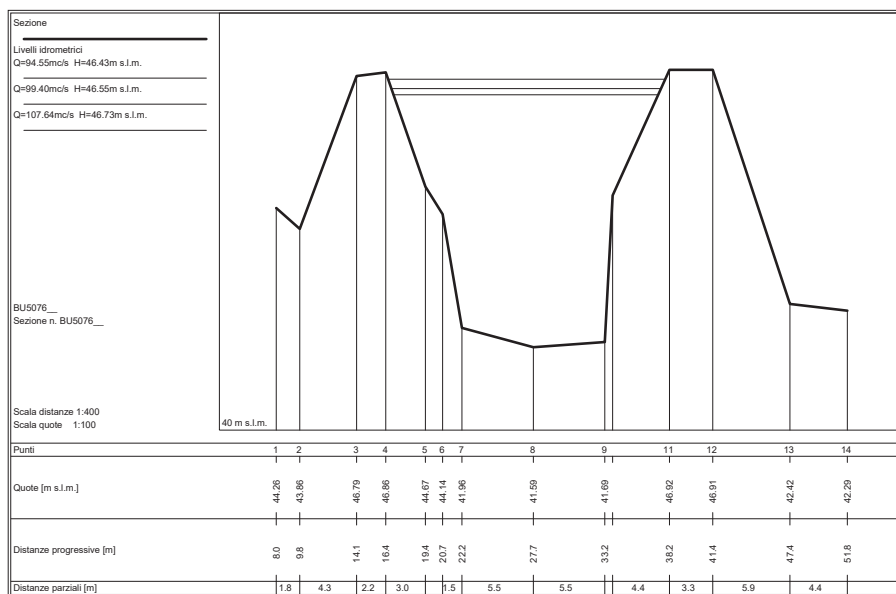
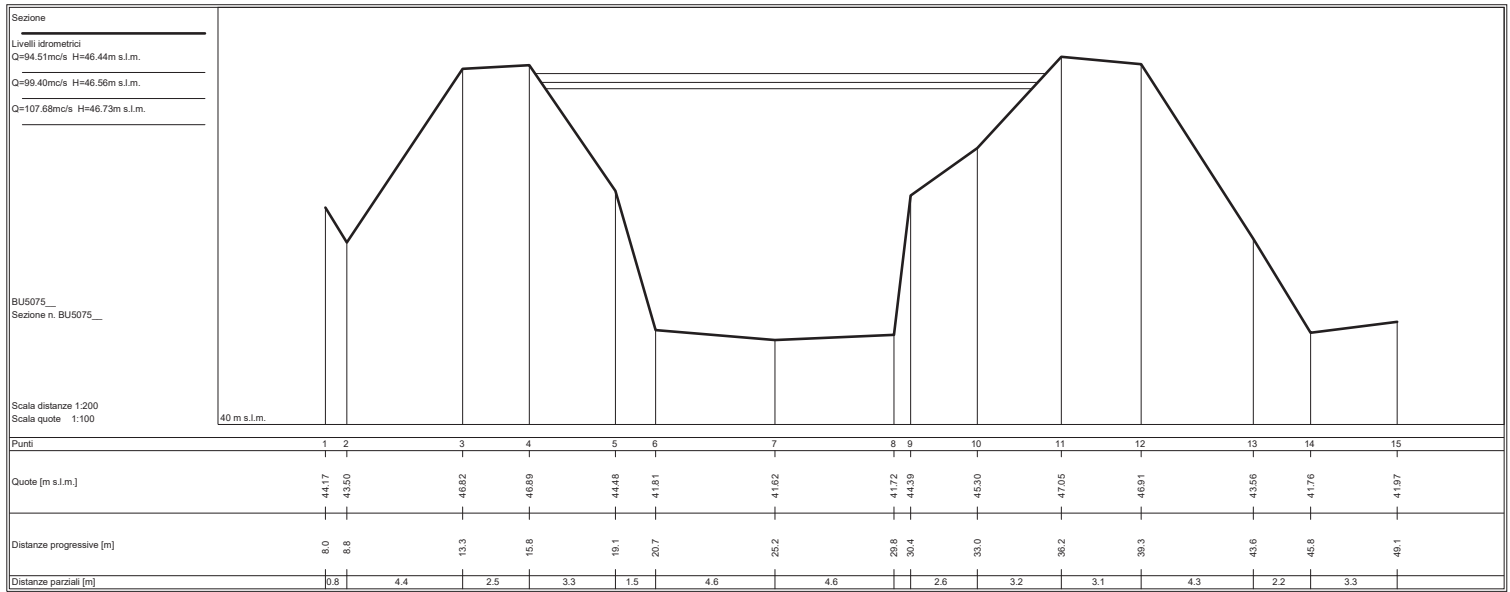

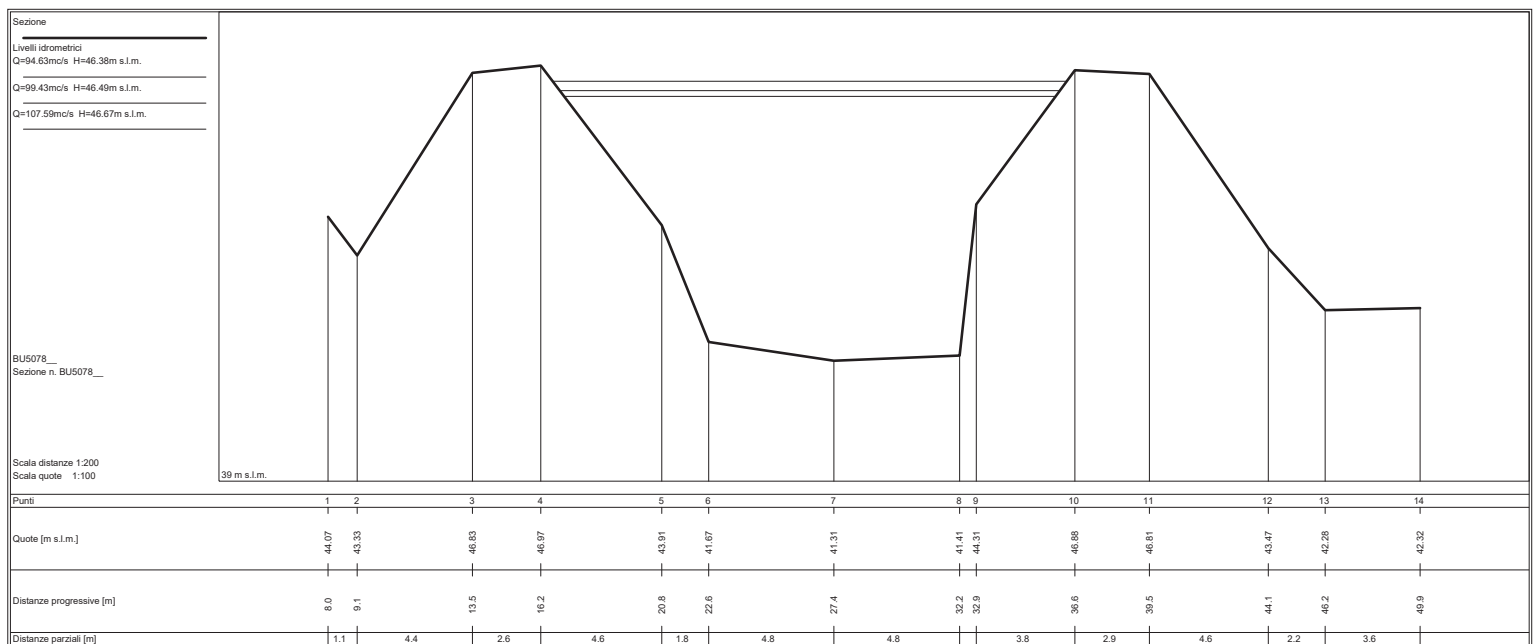
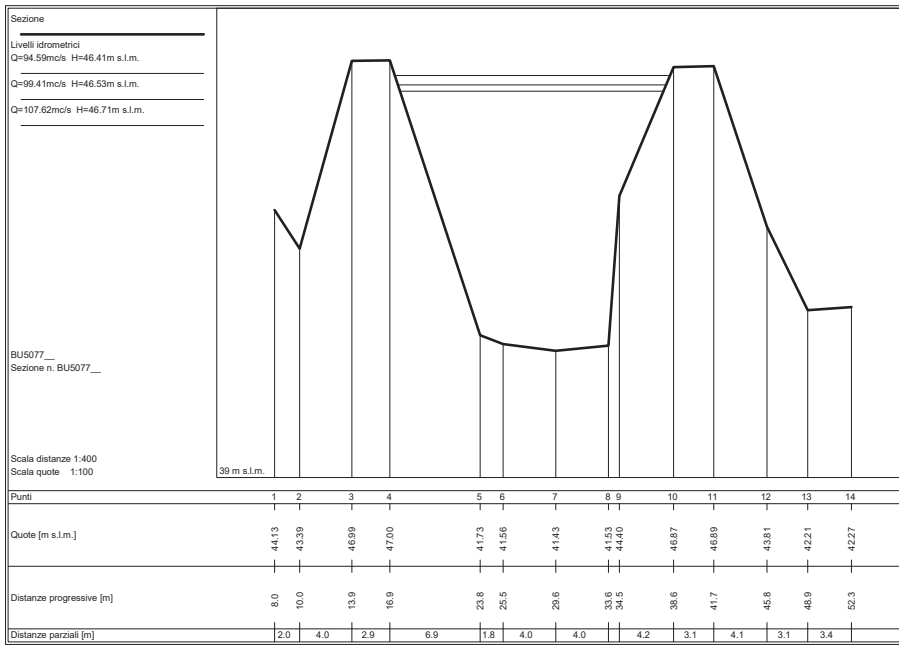

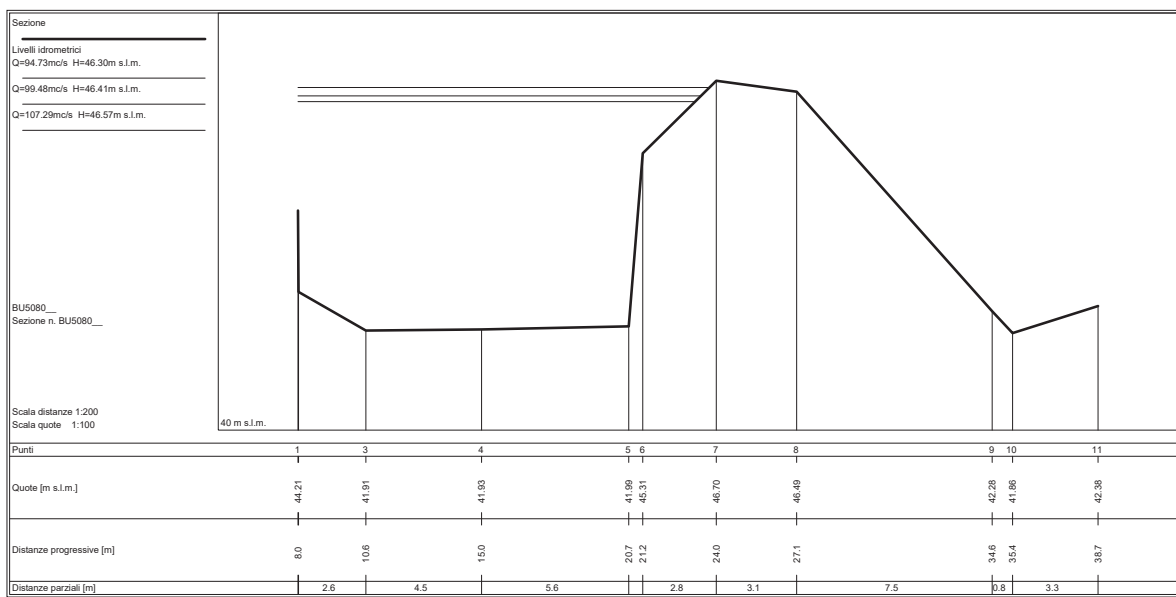
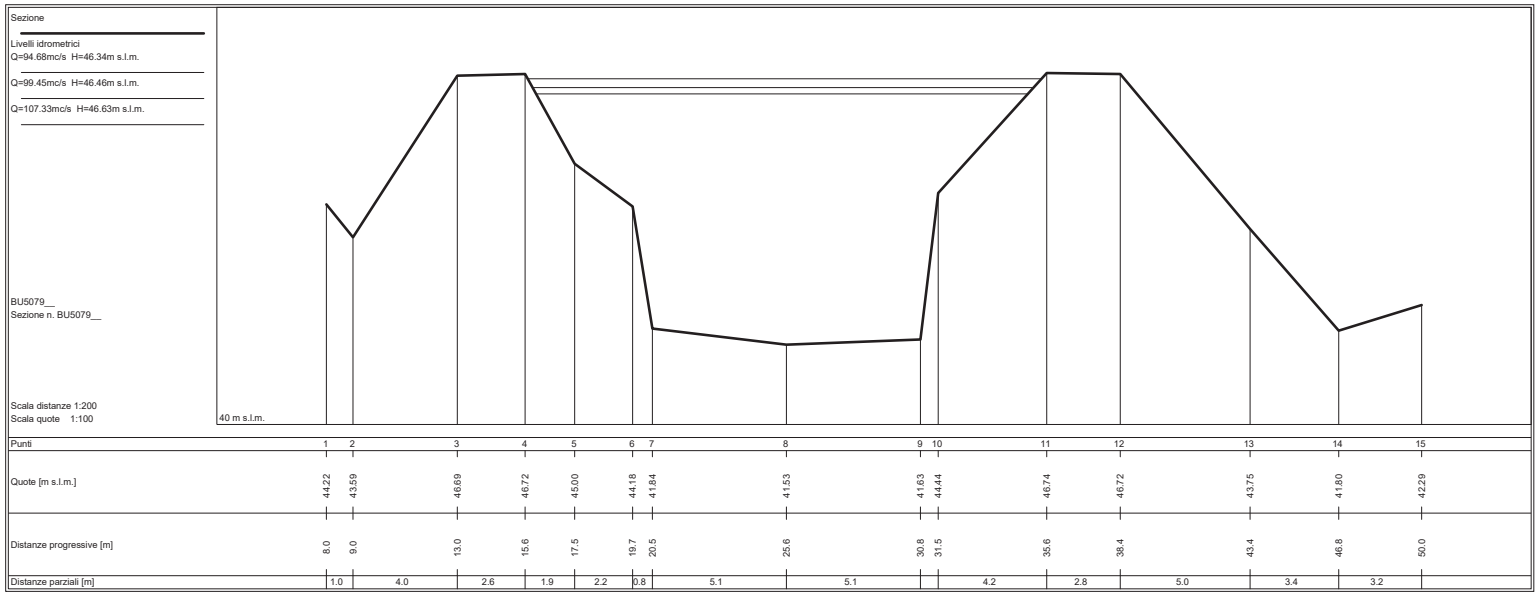

SEZIONI FLUVIALI  
TORRENTE BURE - TRATTO 4

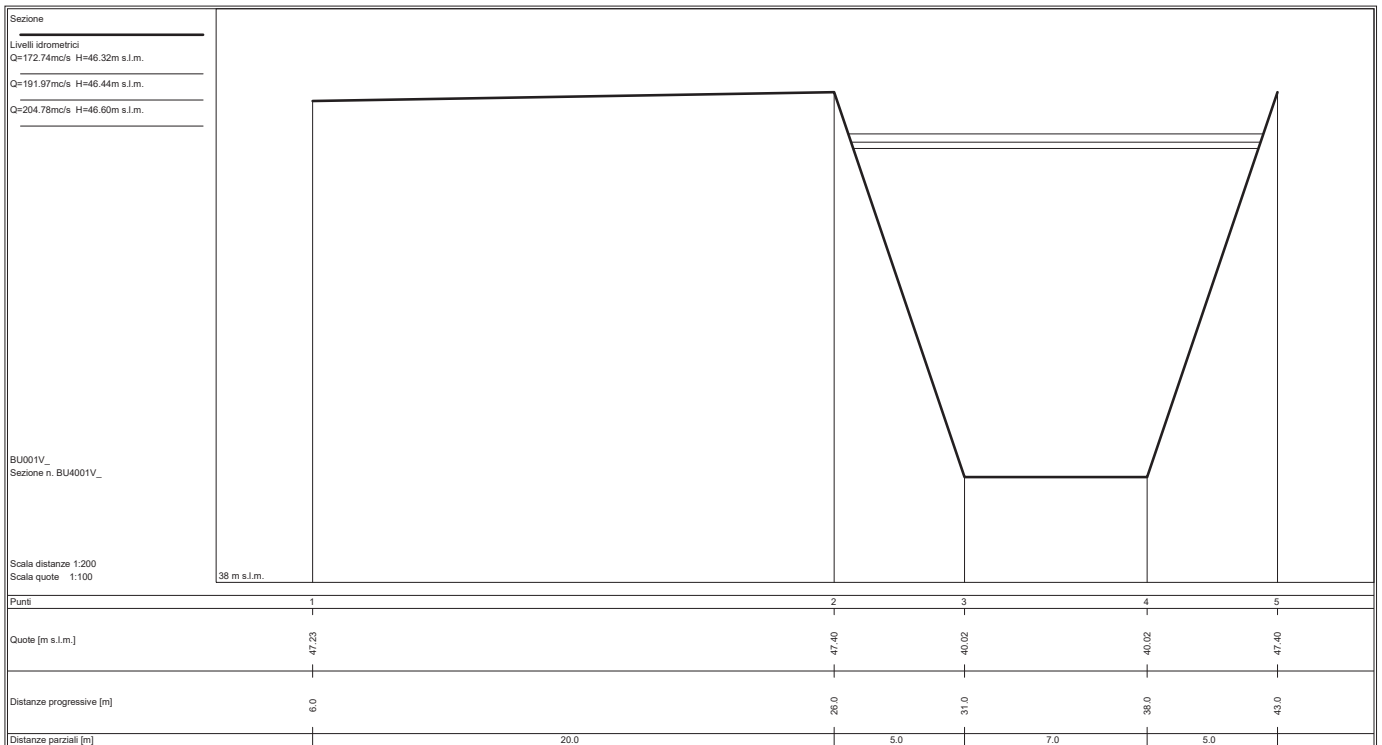
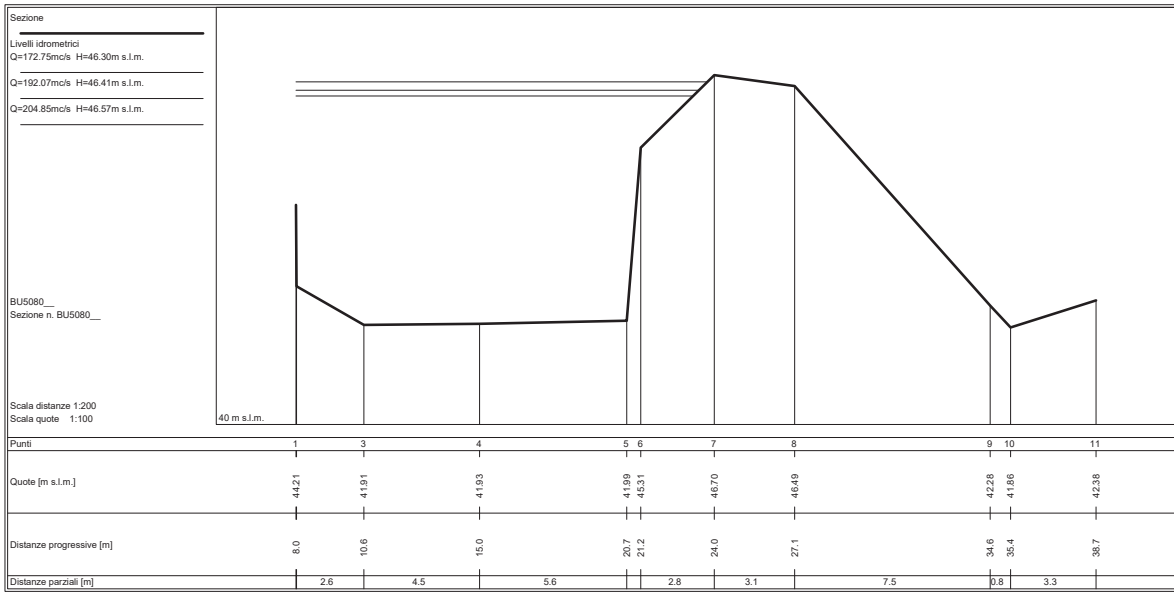



SEZIONI FLUVIALI  
TORRENTE CALICE

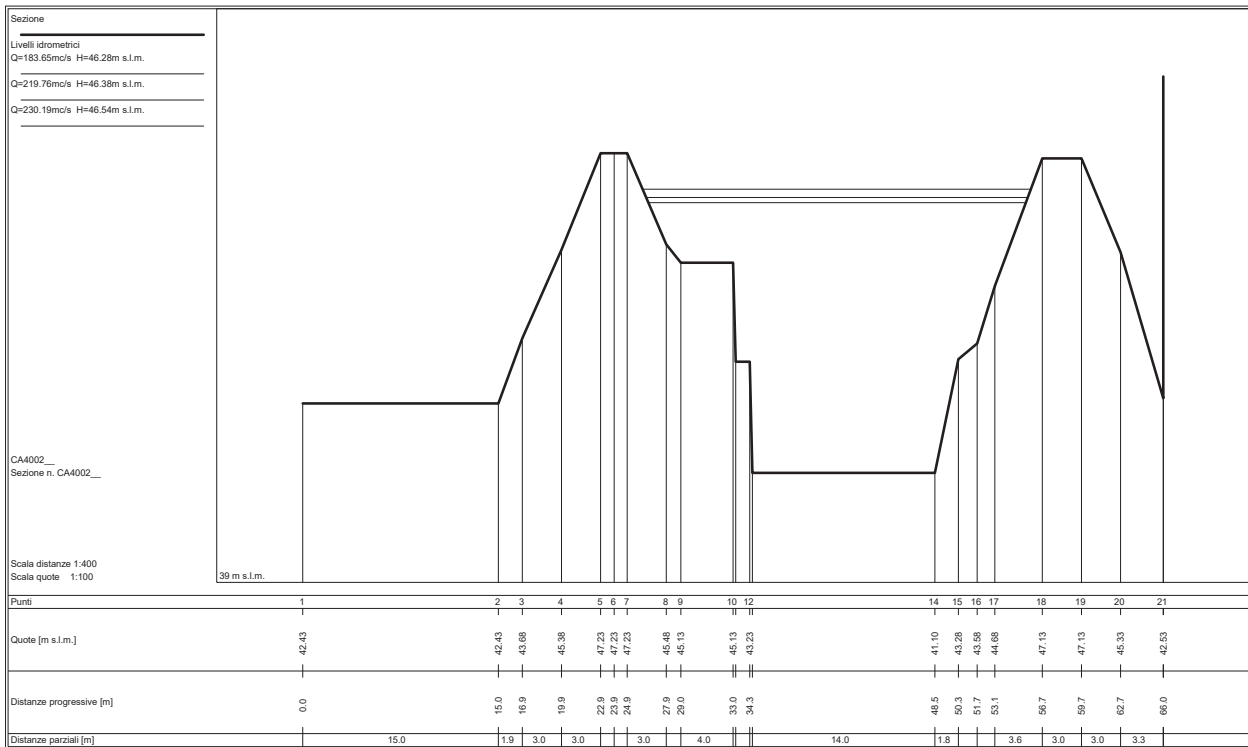
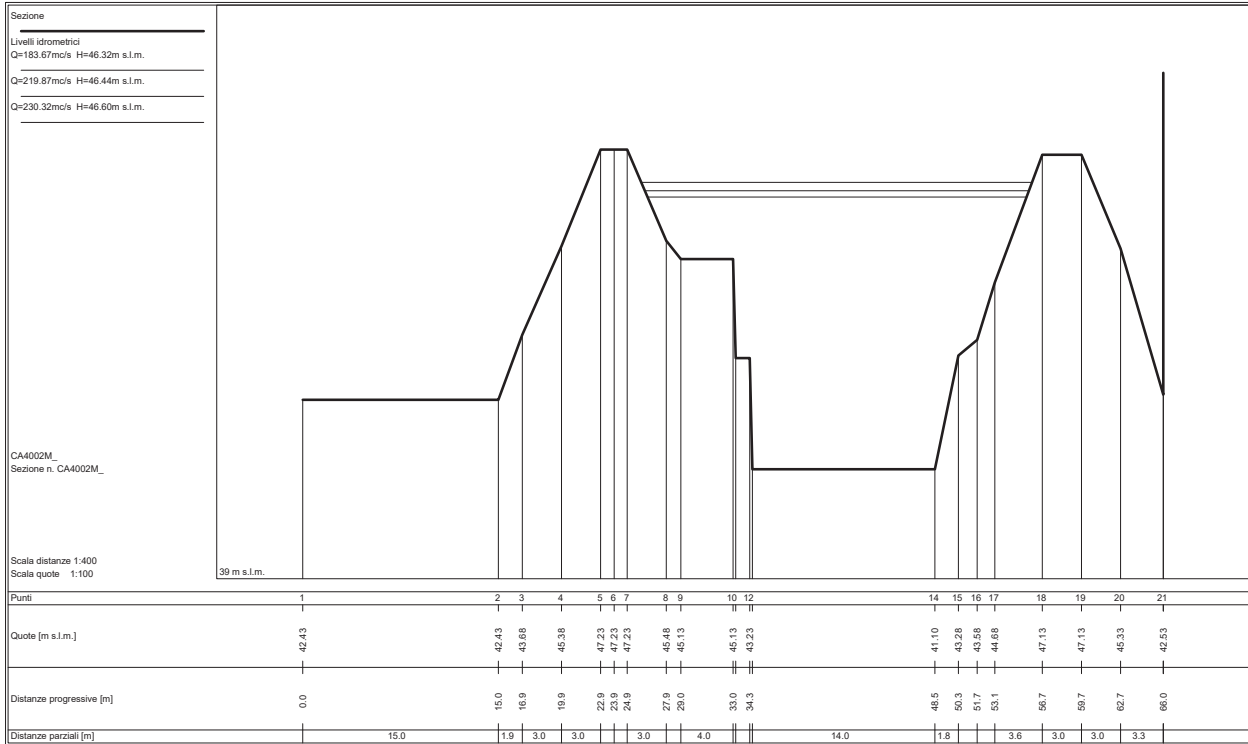

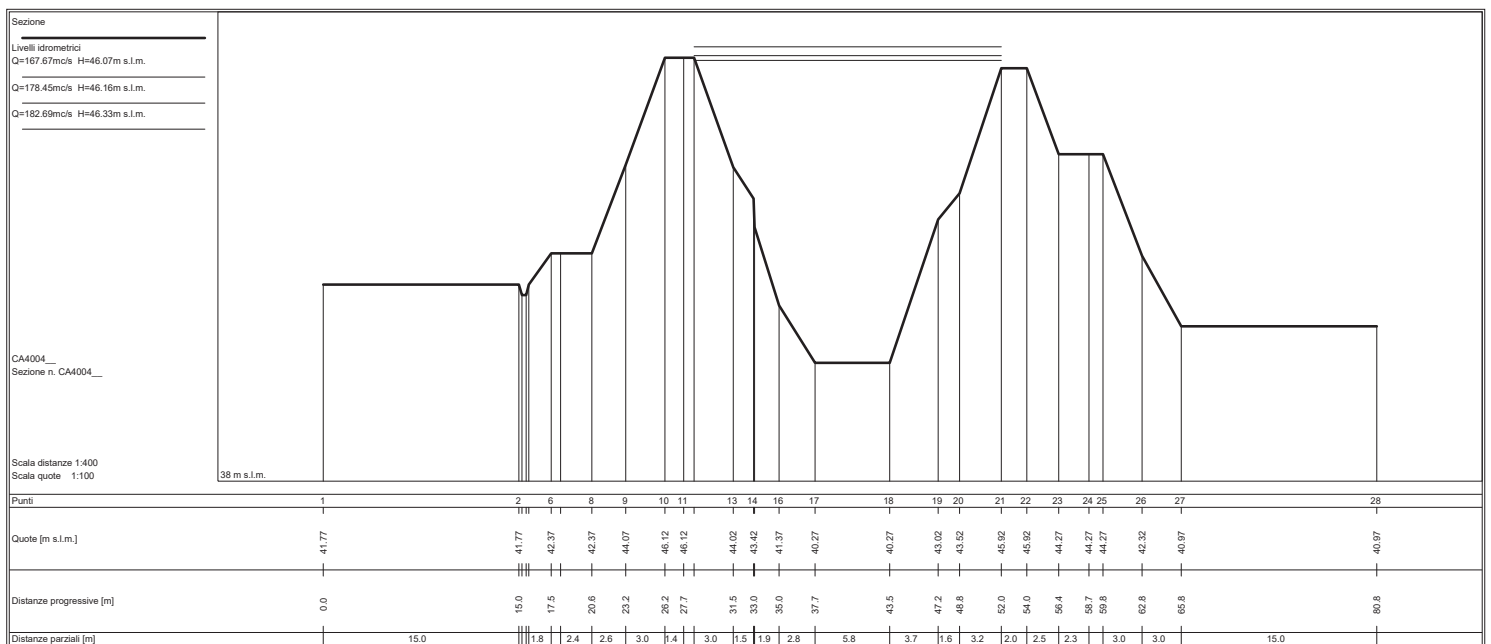
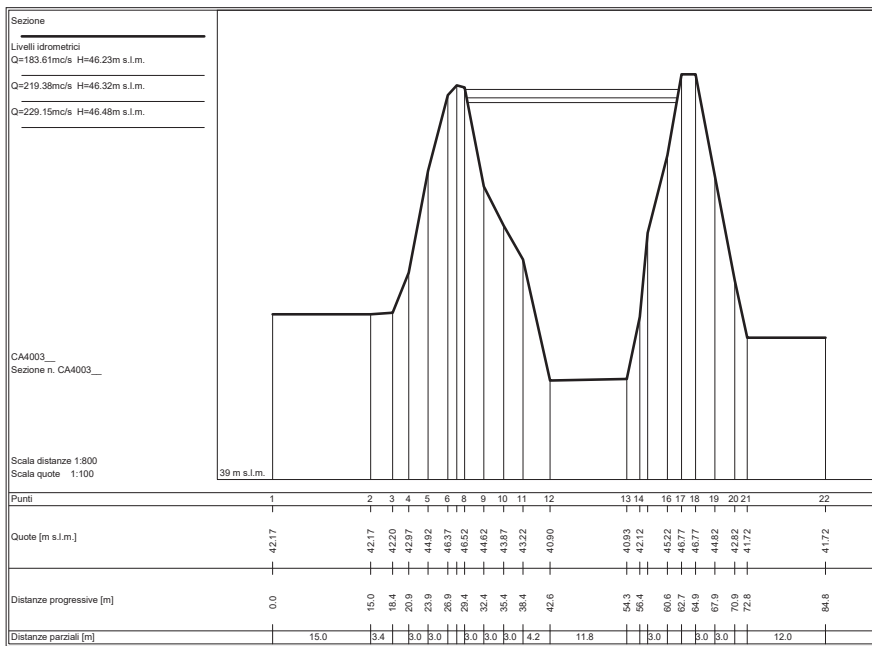

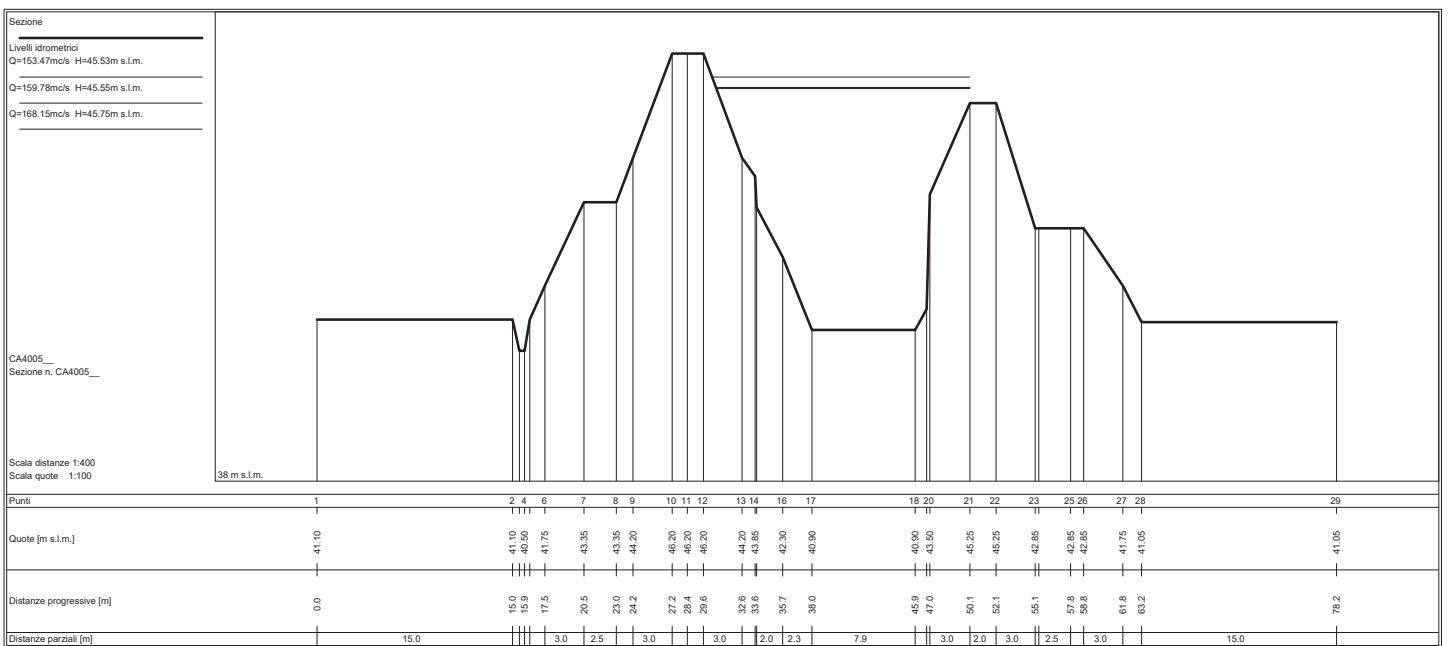
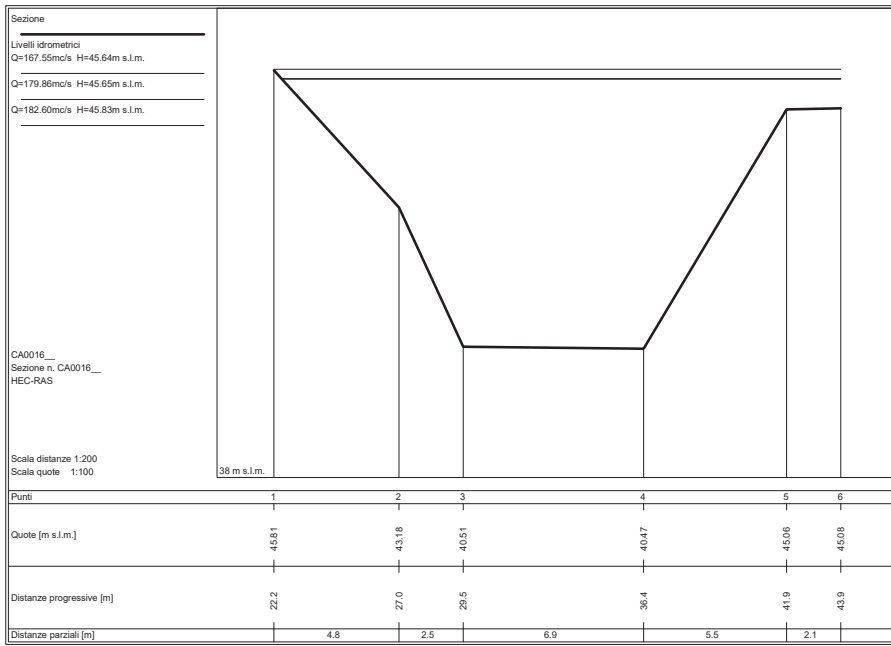

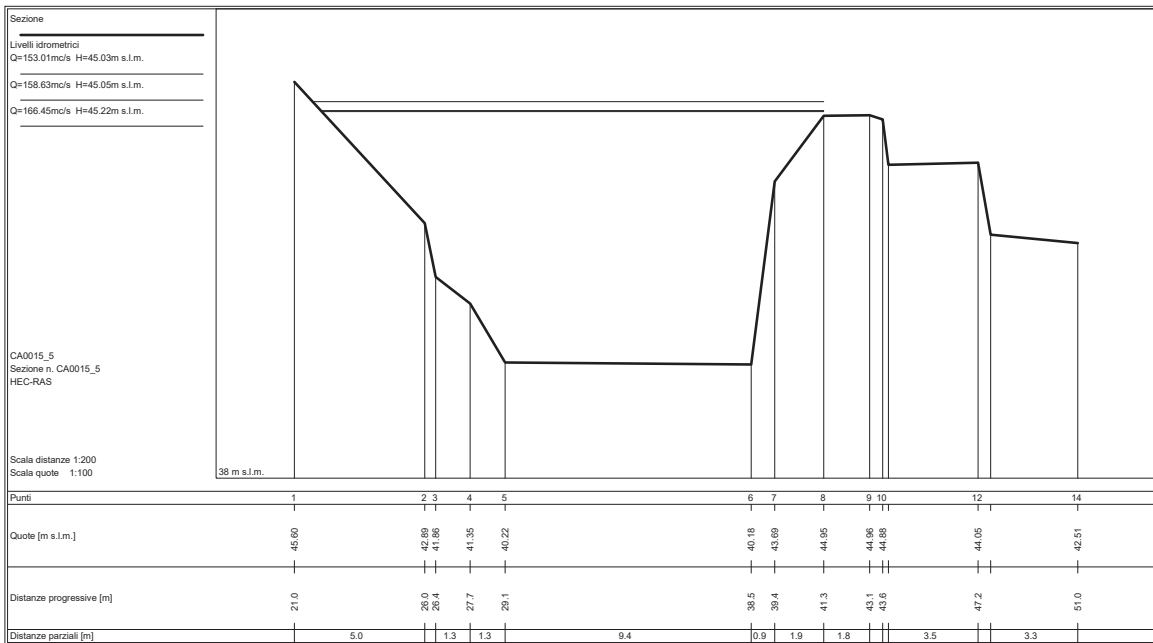
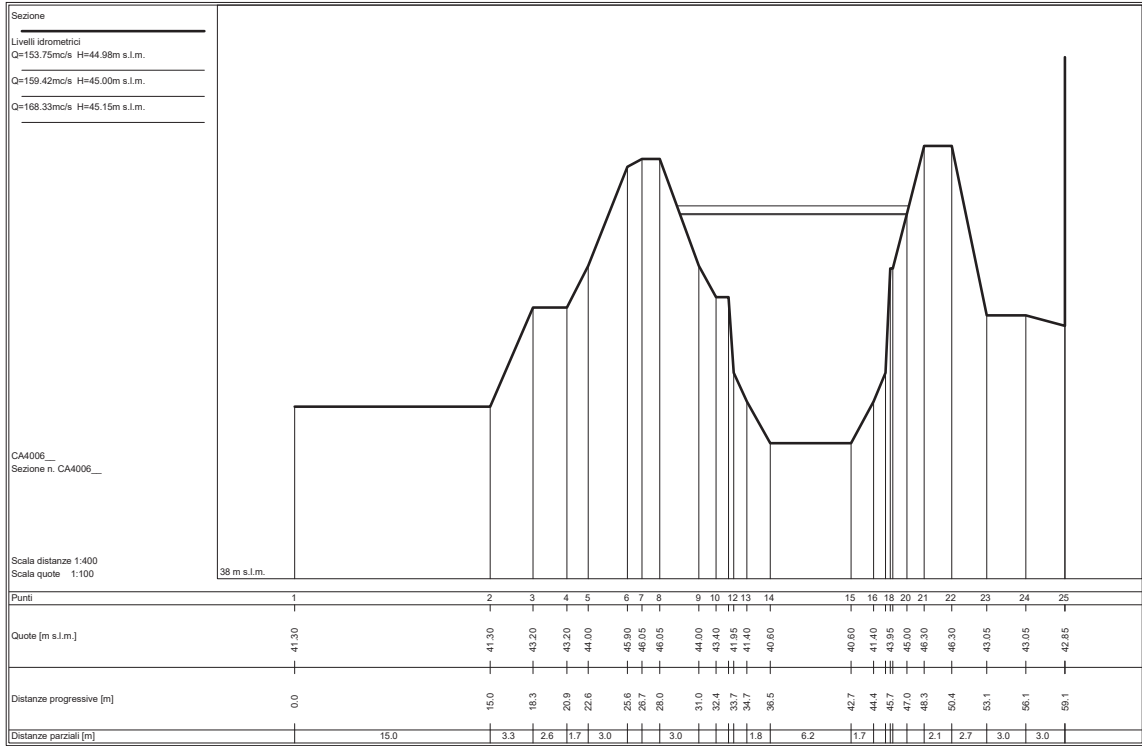

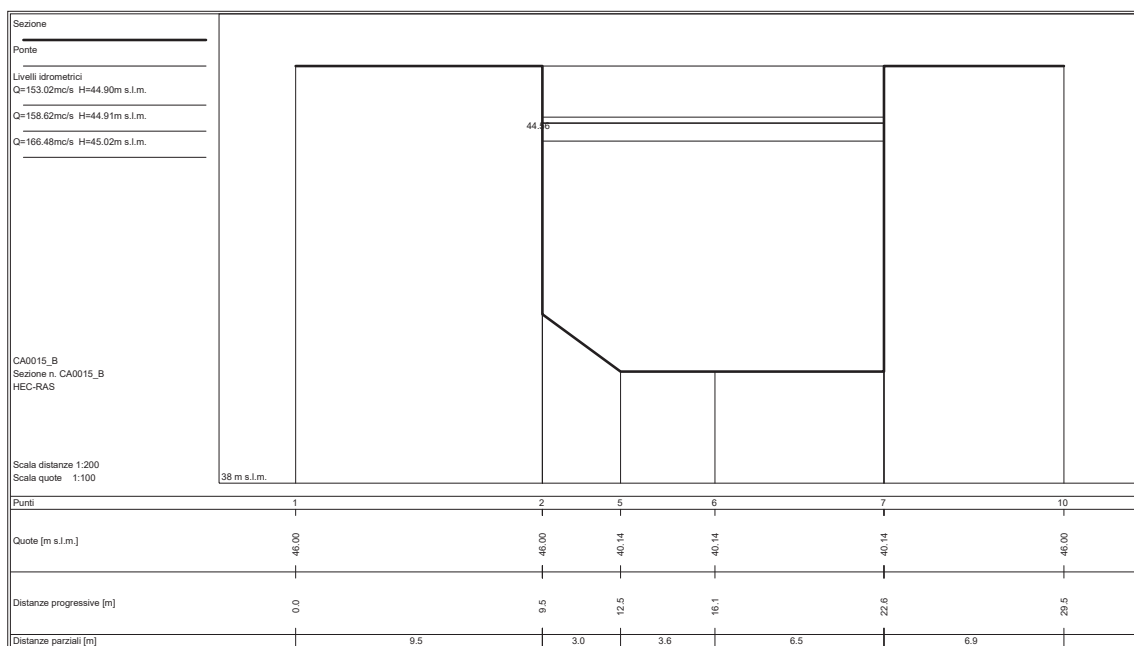
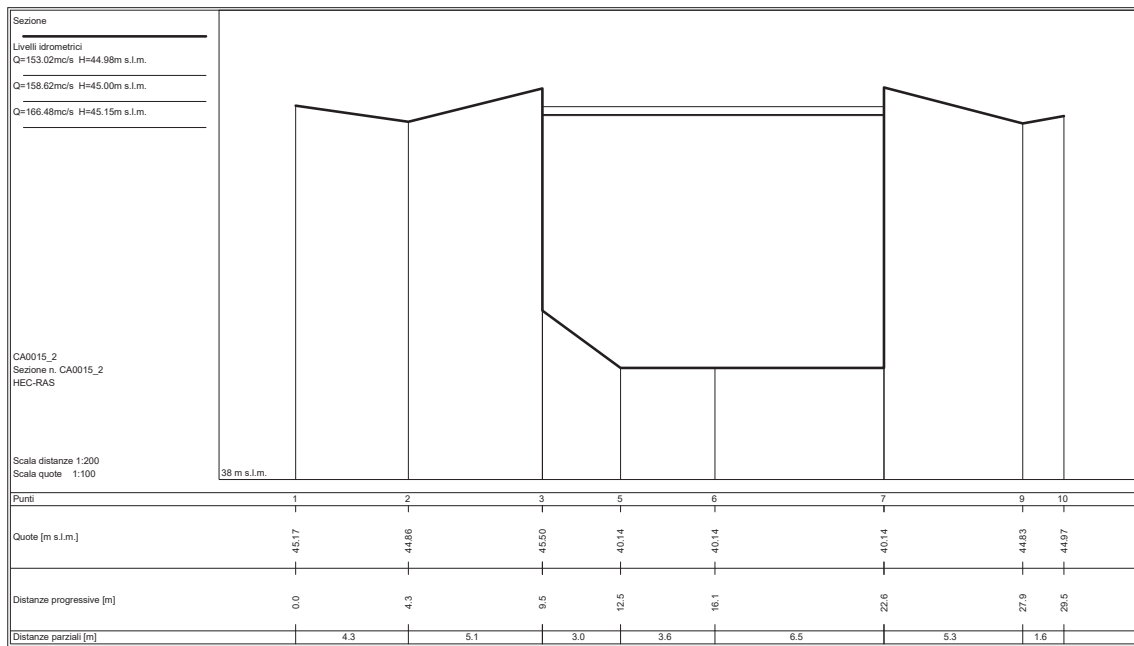

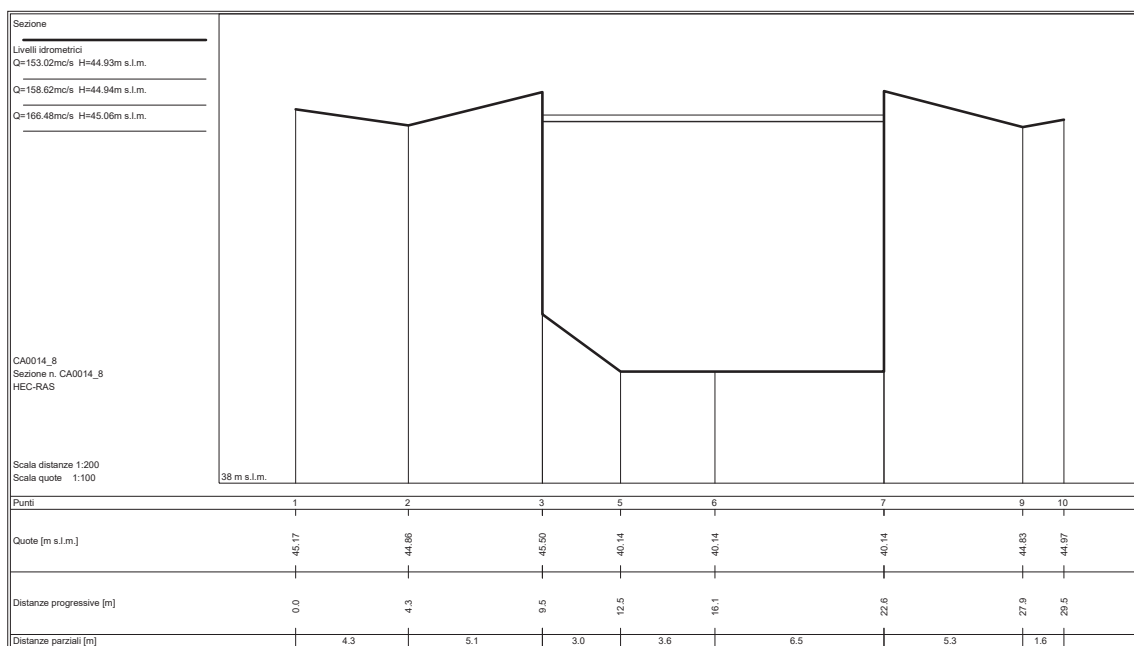
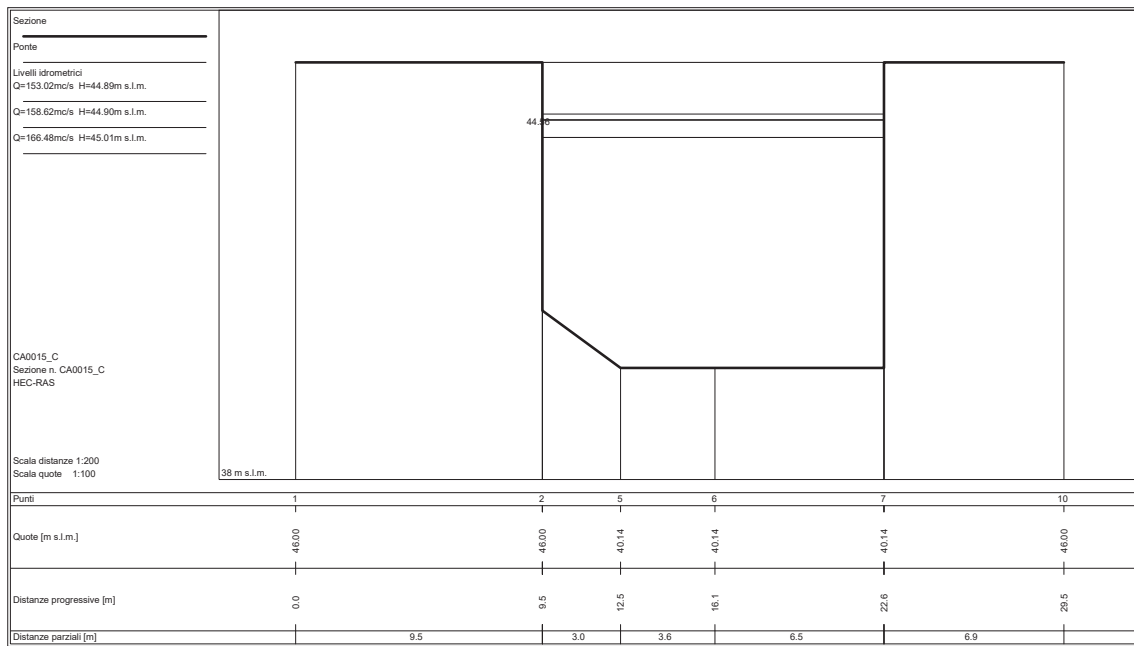

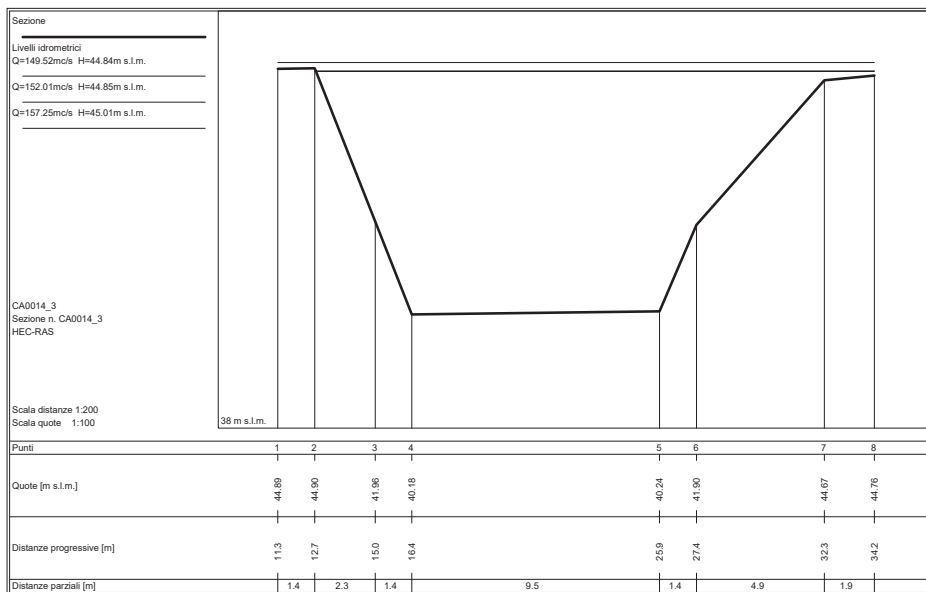
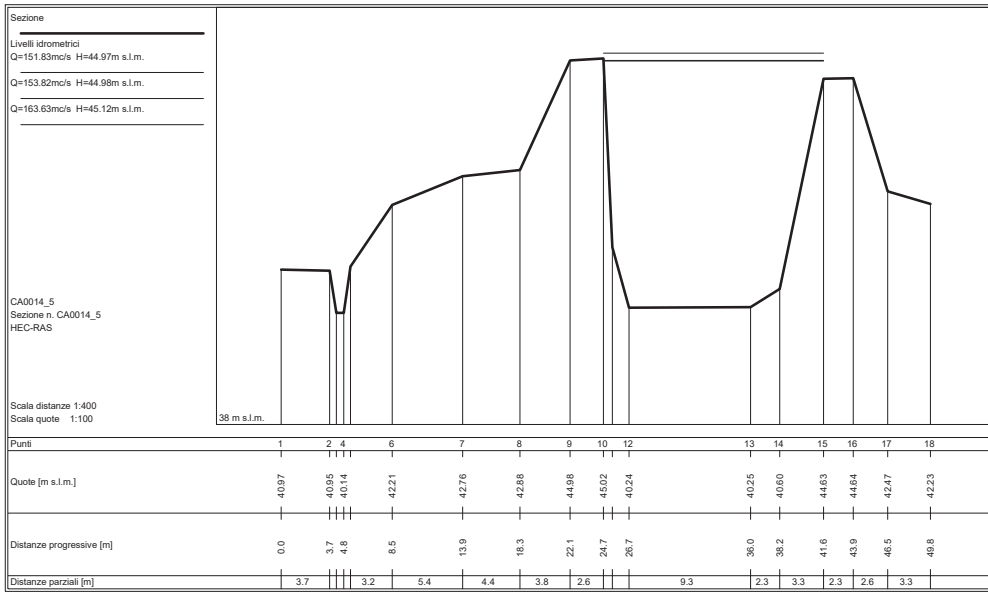



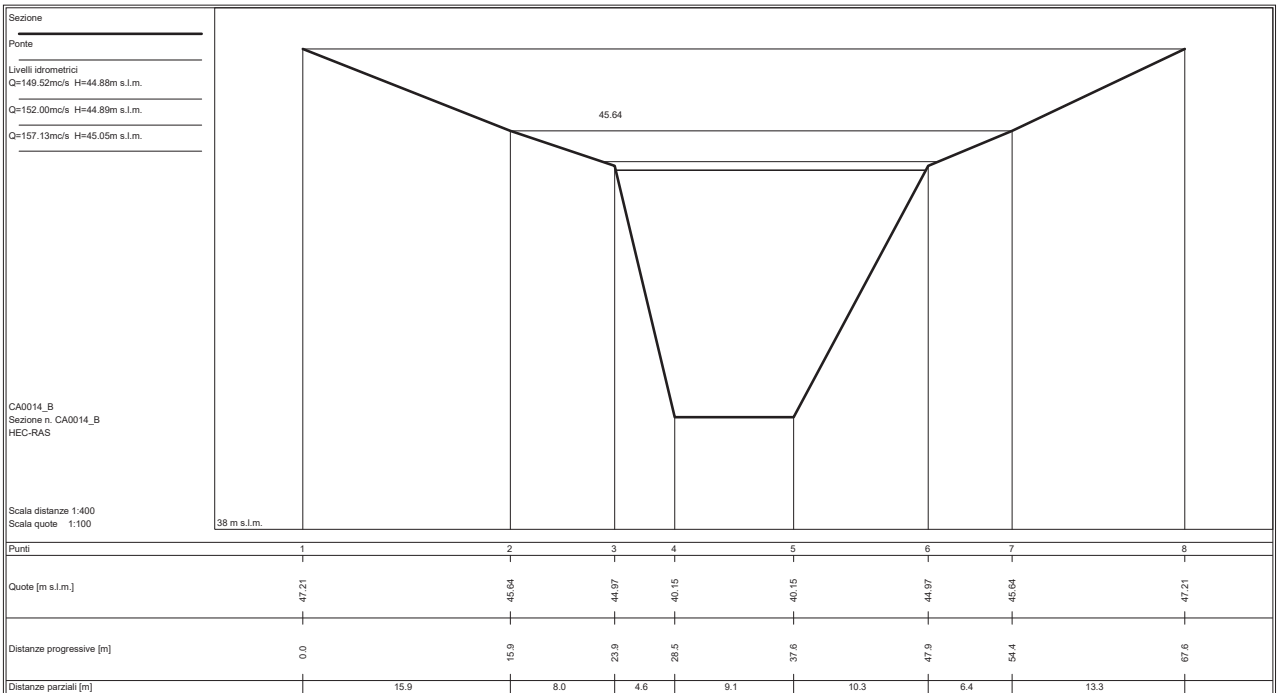
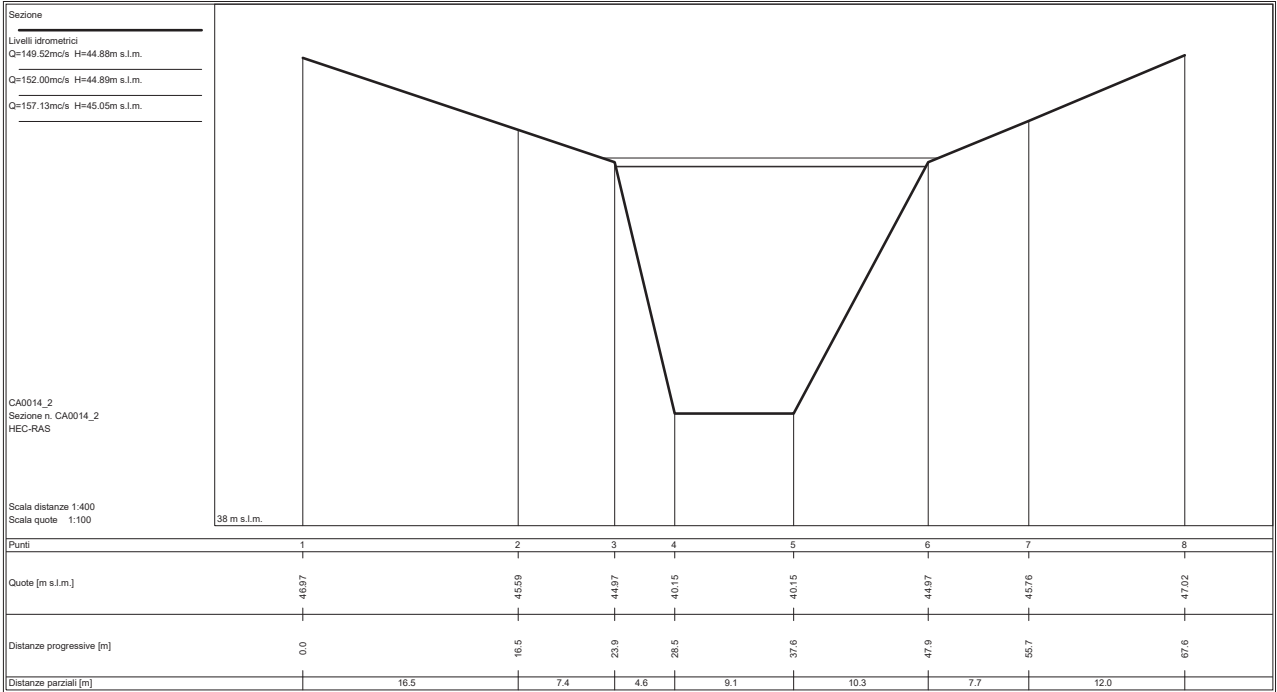

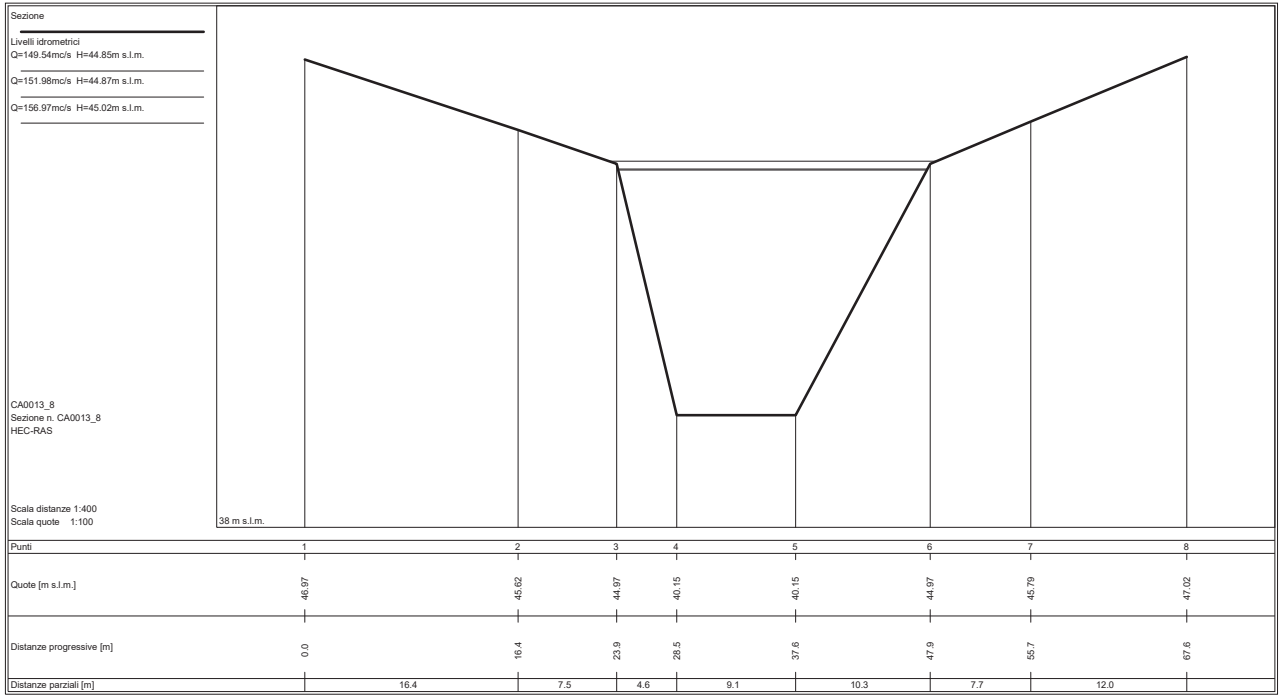
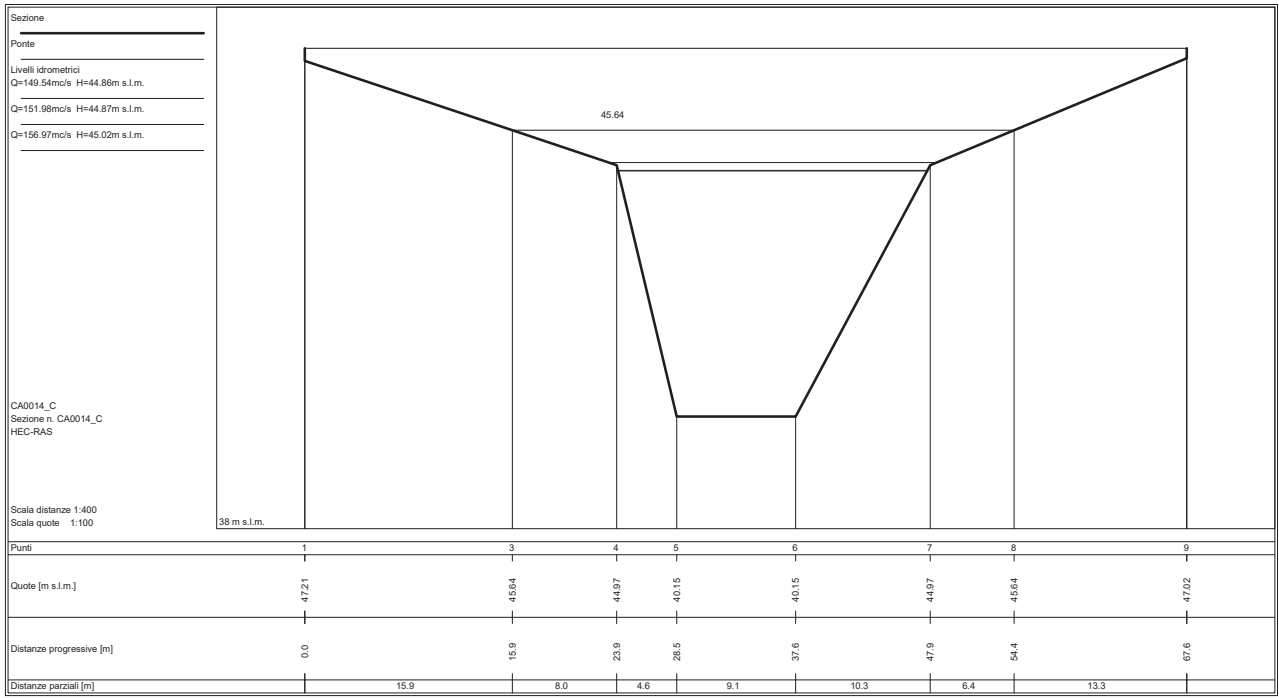

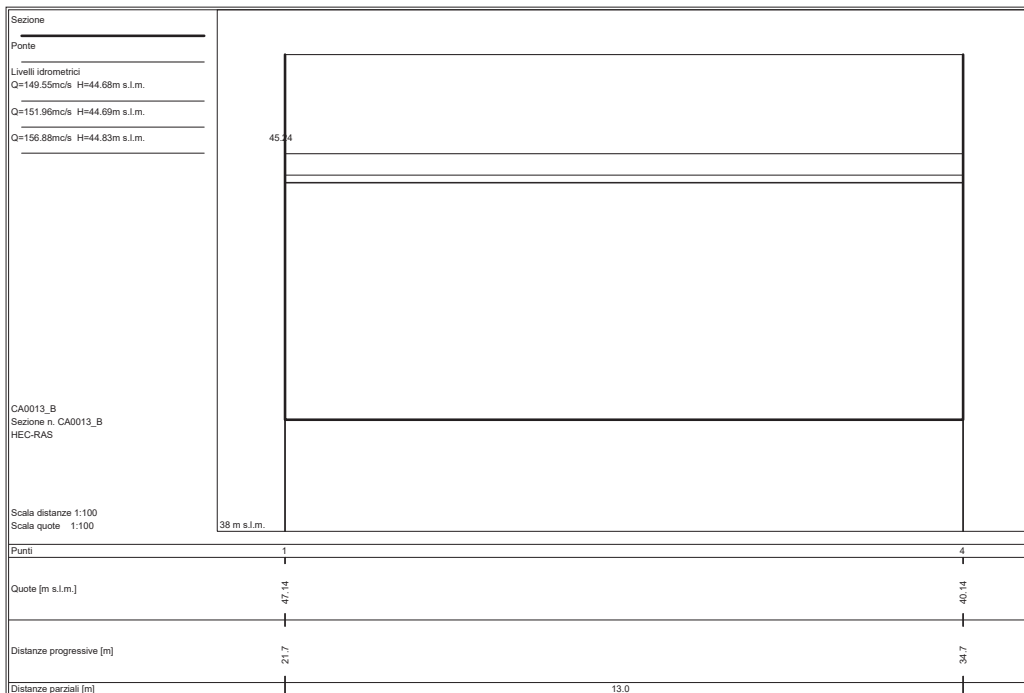

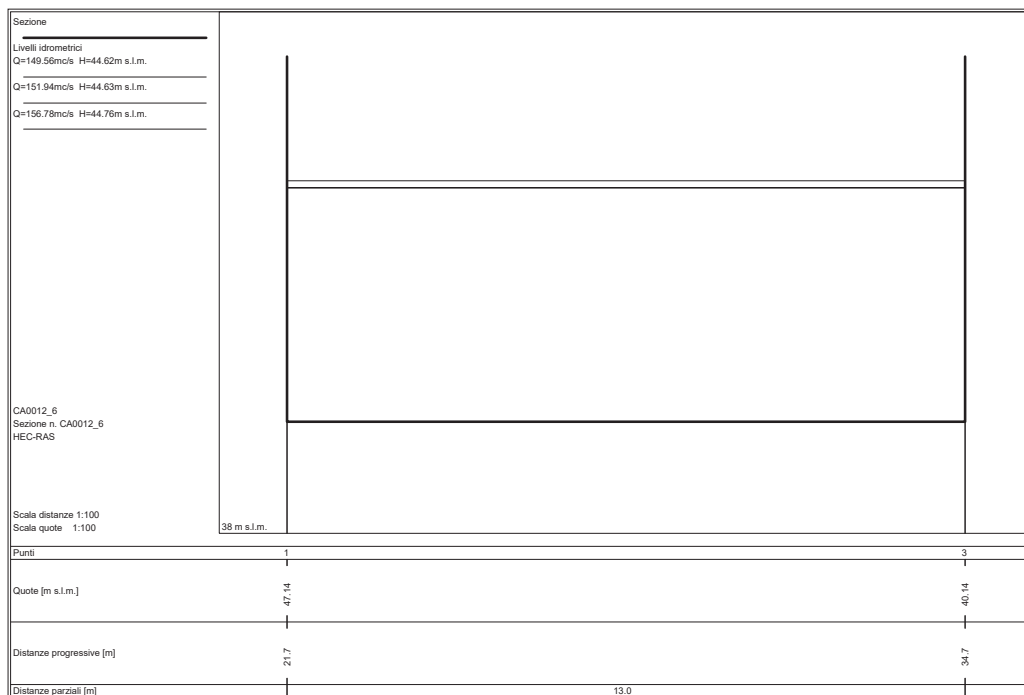
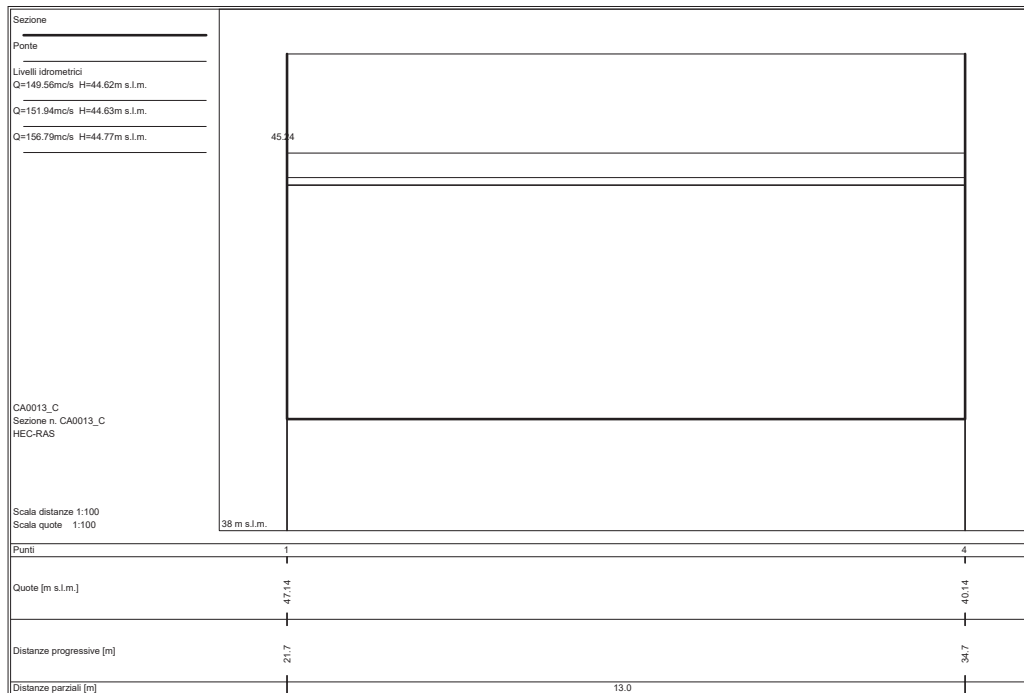

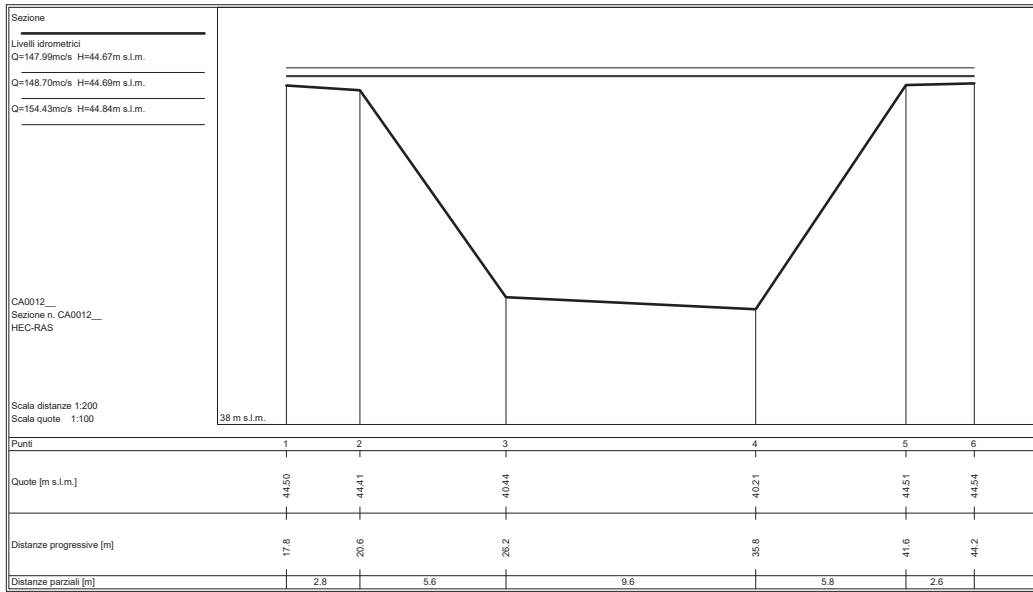

SEZIONI FLUVIALI  
TORRENTE CALICINO

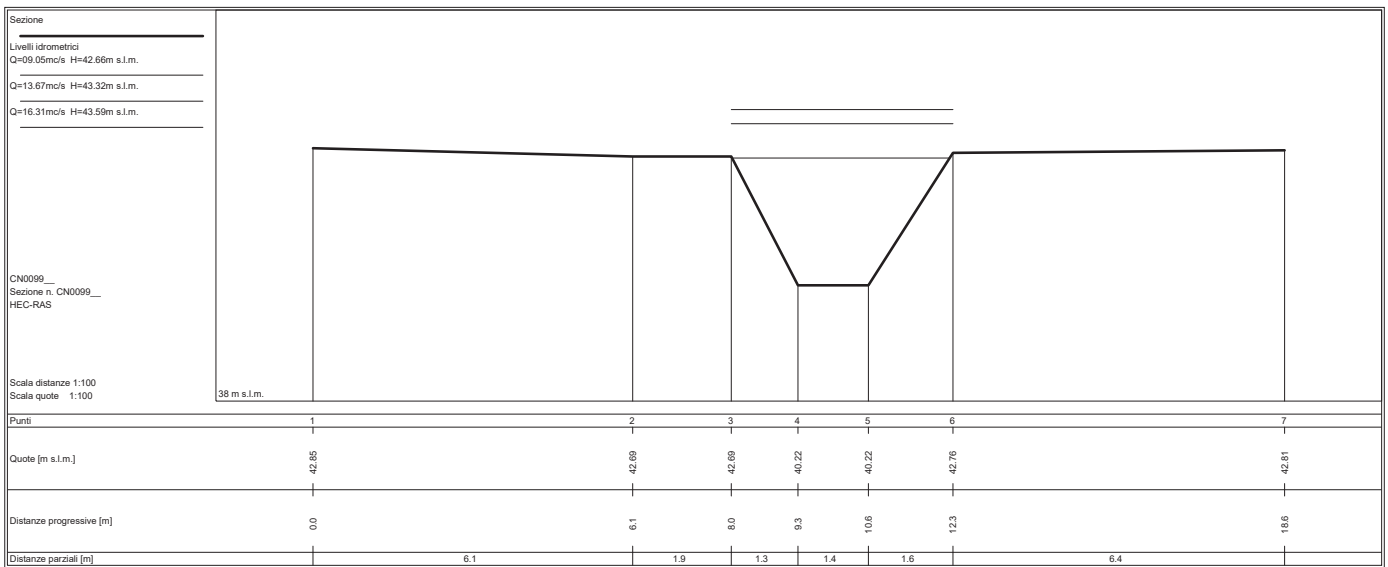
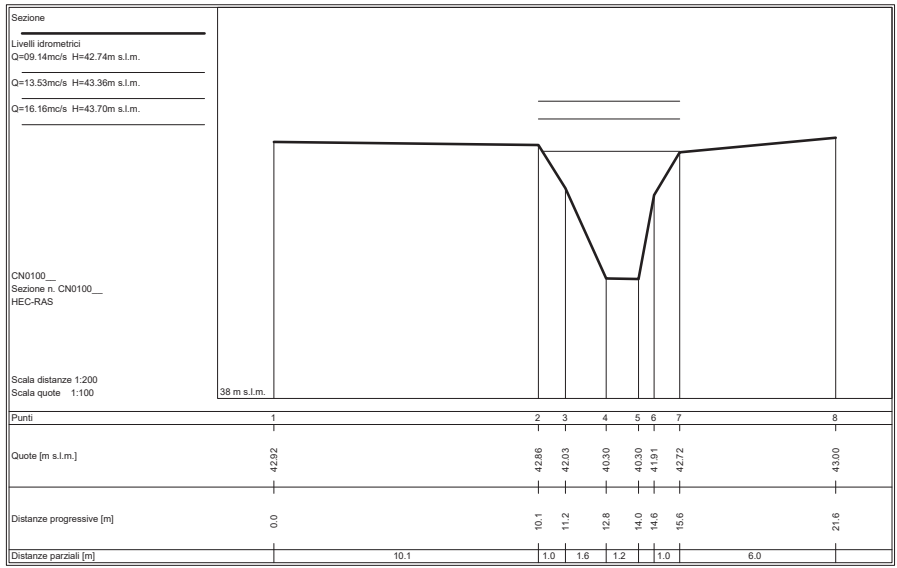

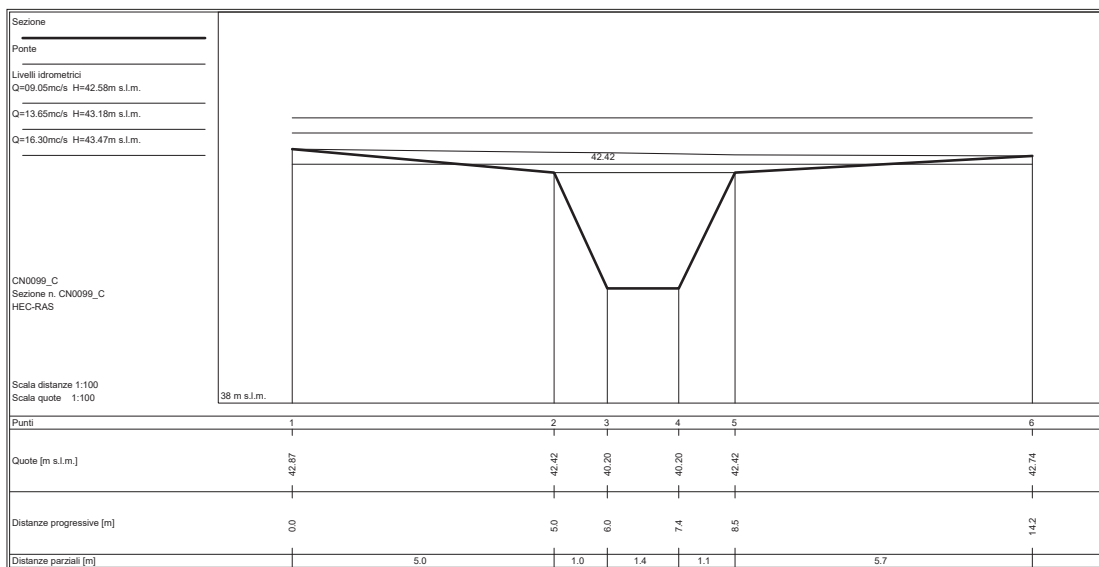
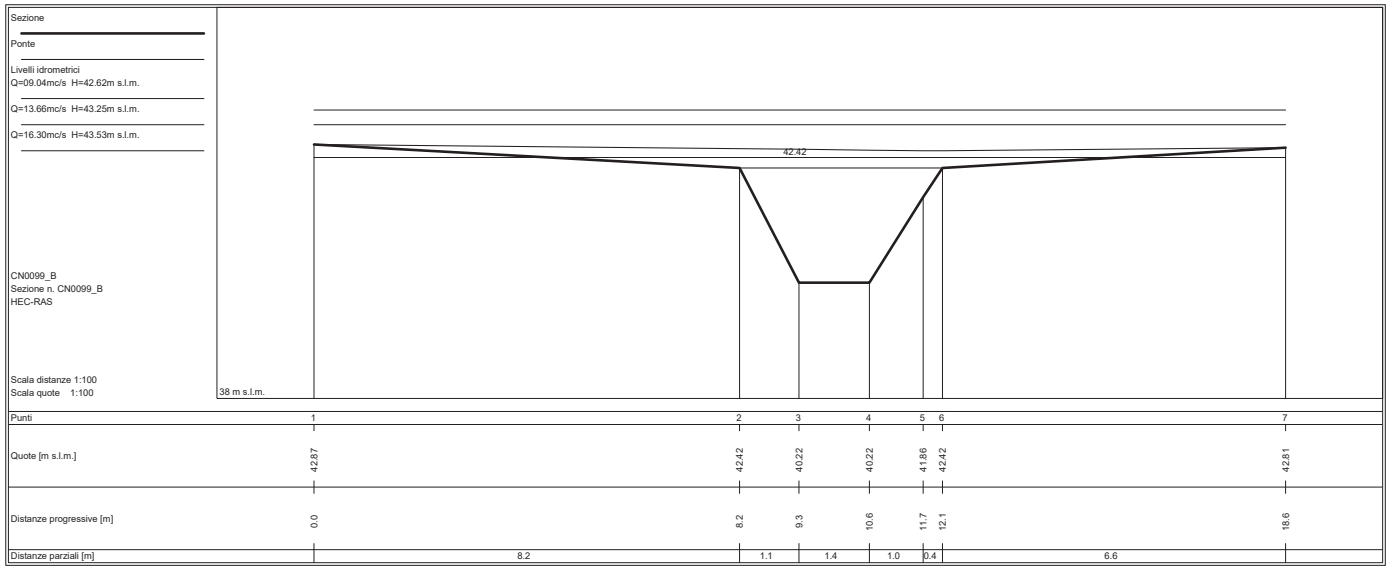



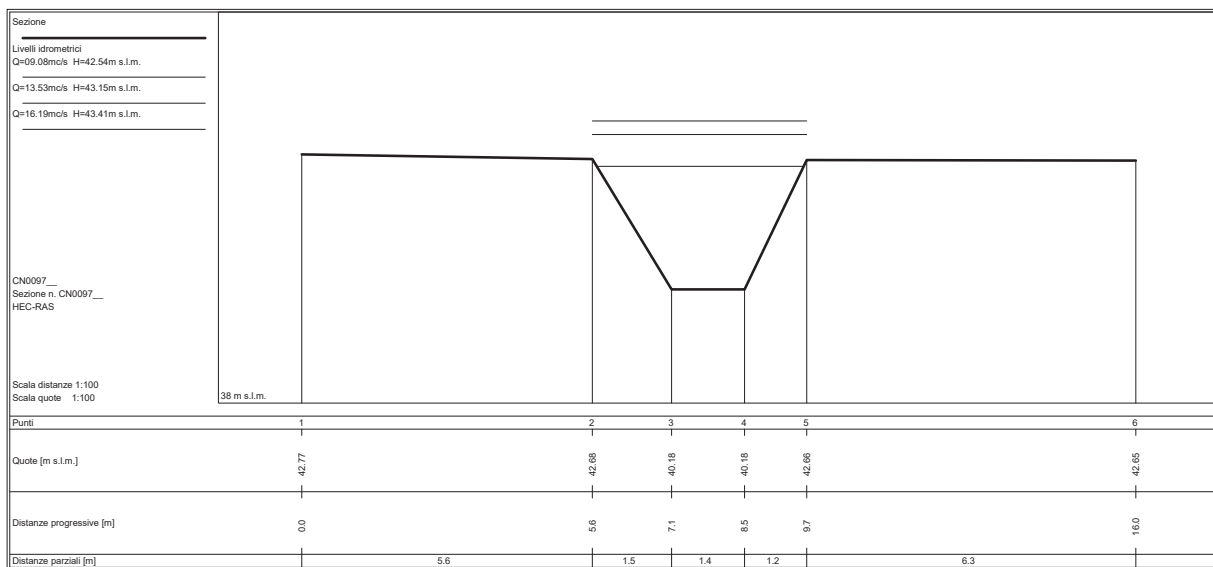
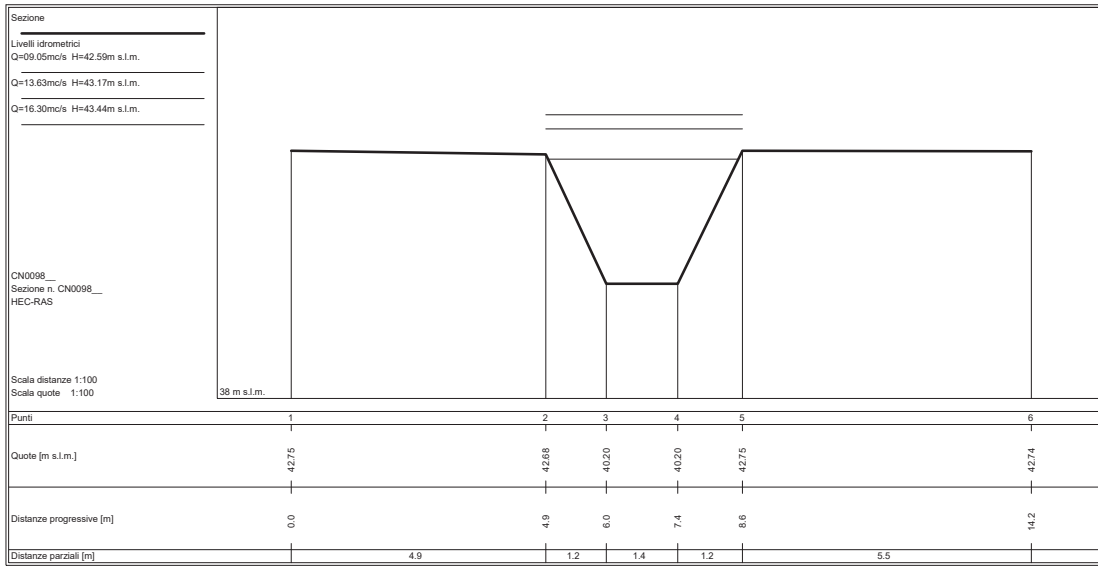

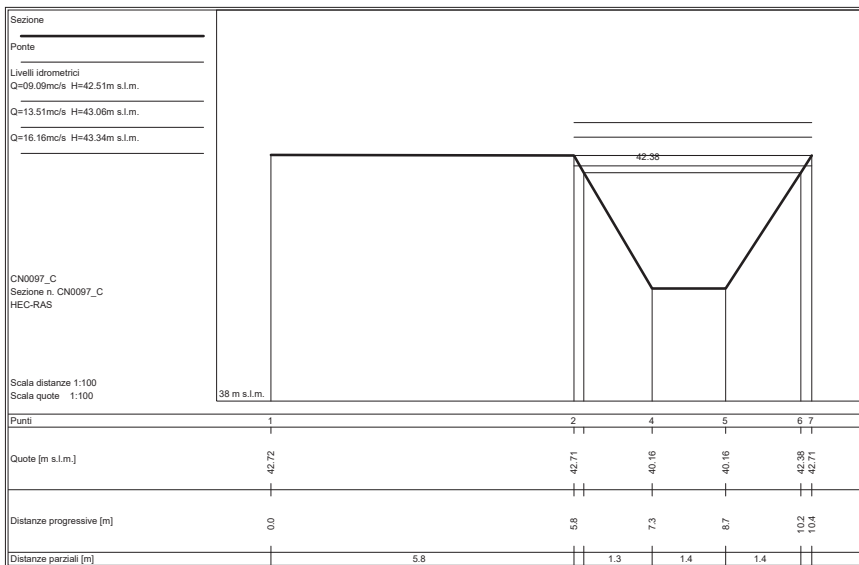
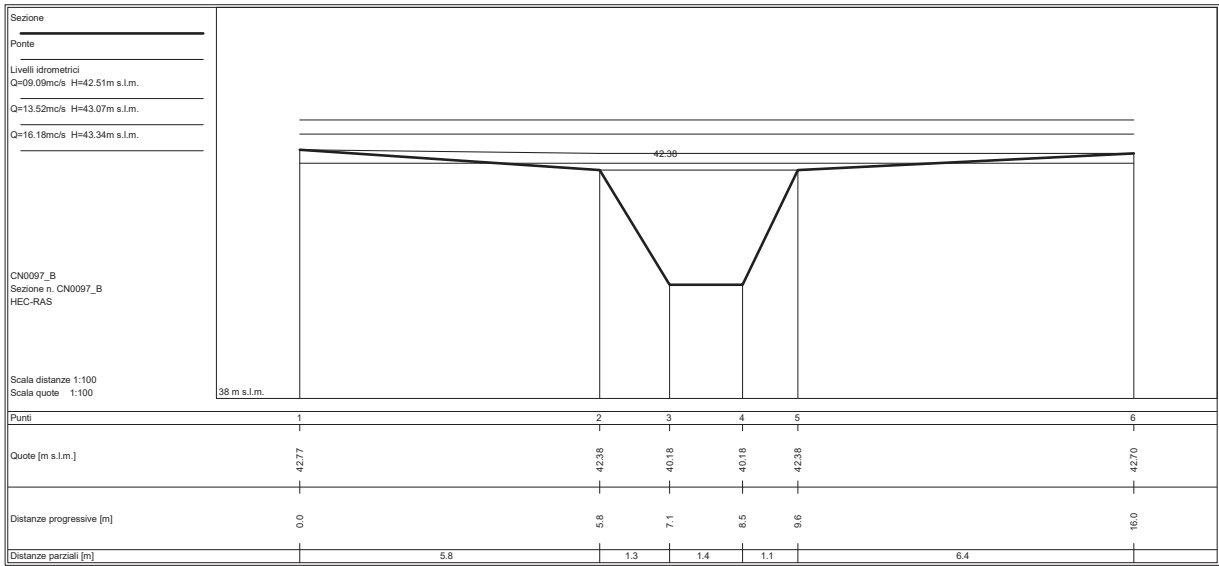

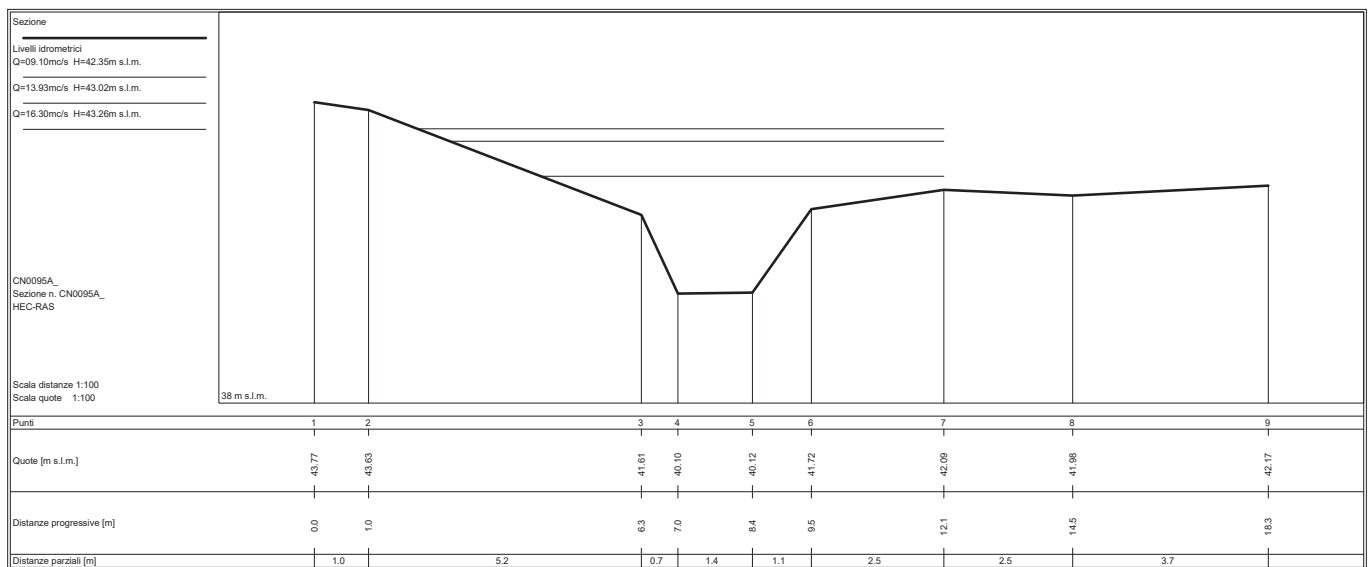
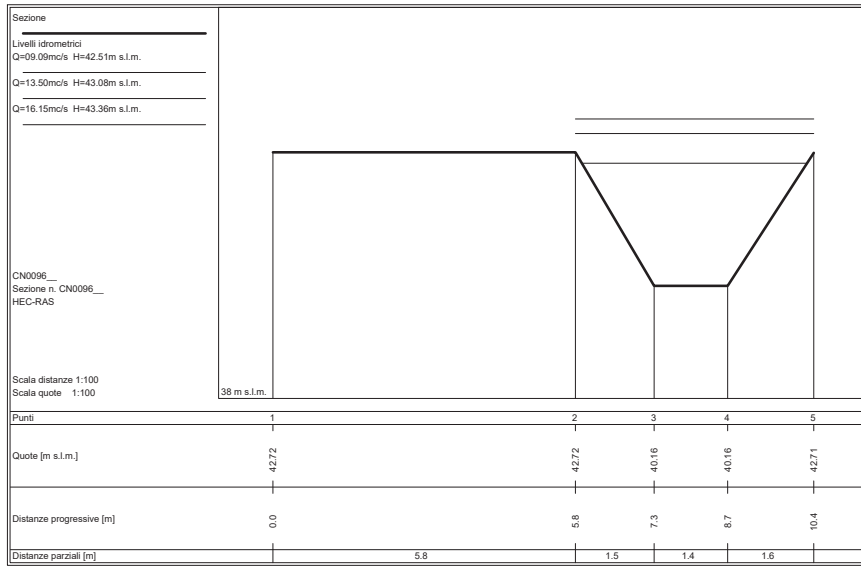

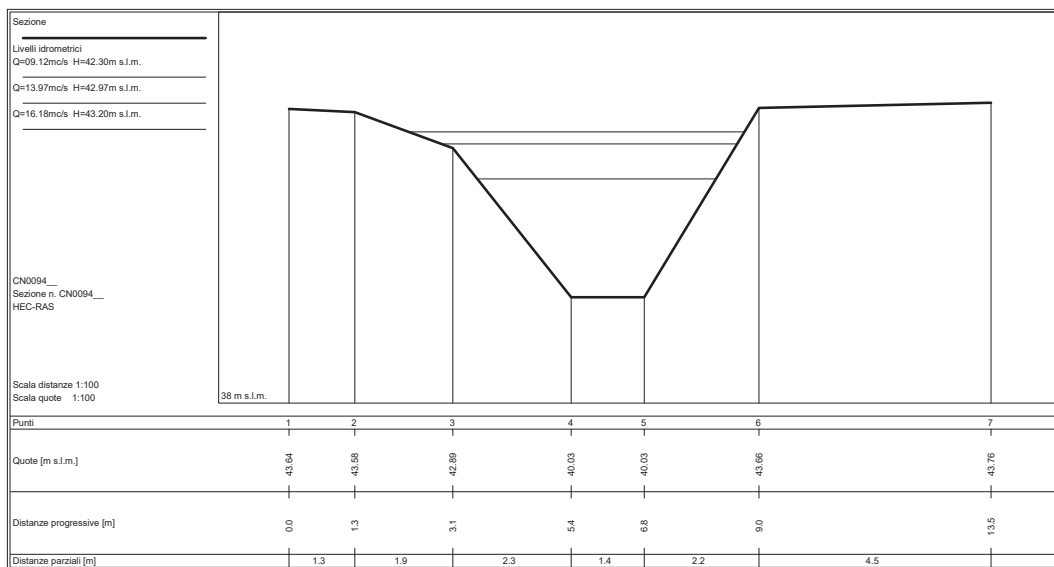
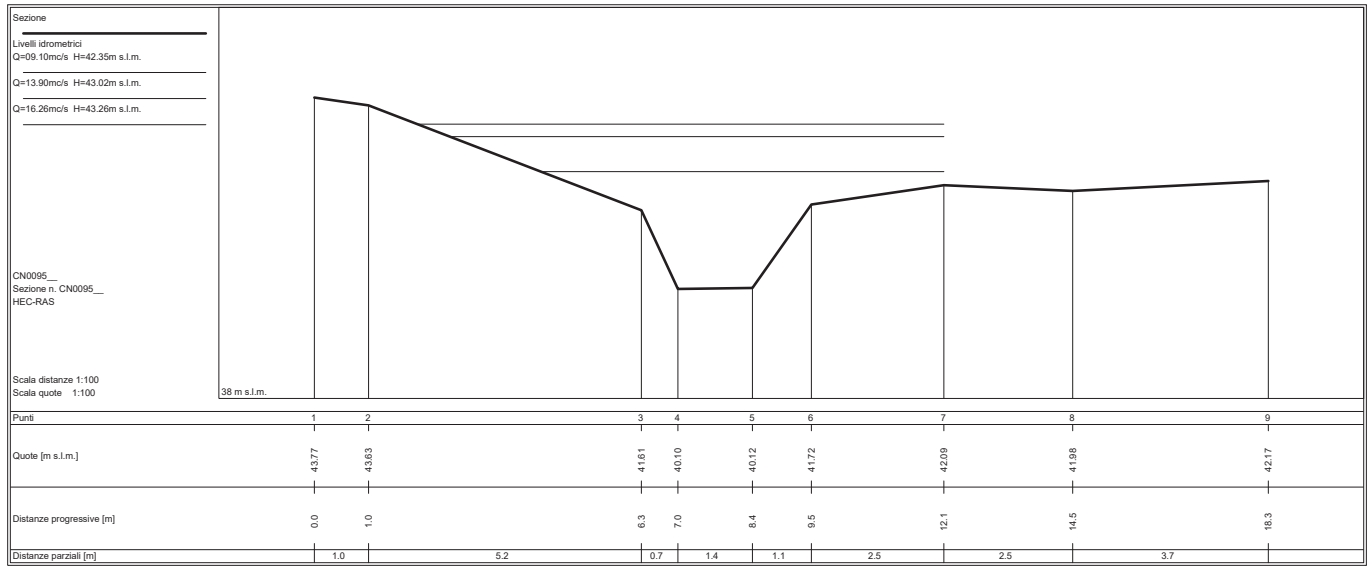

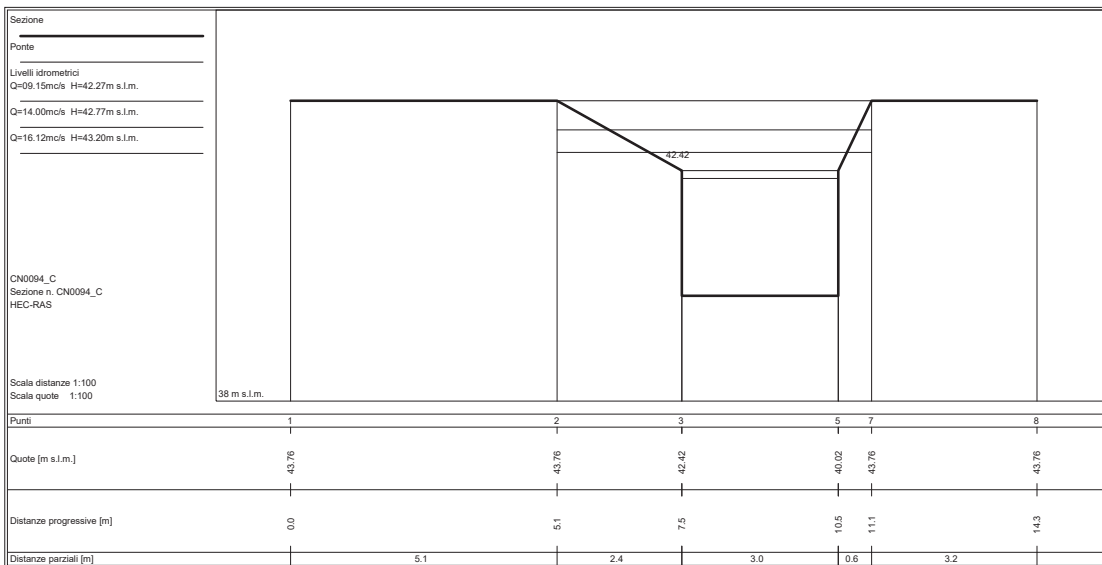
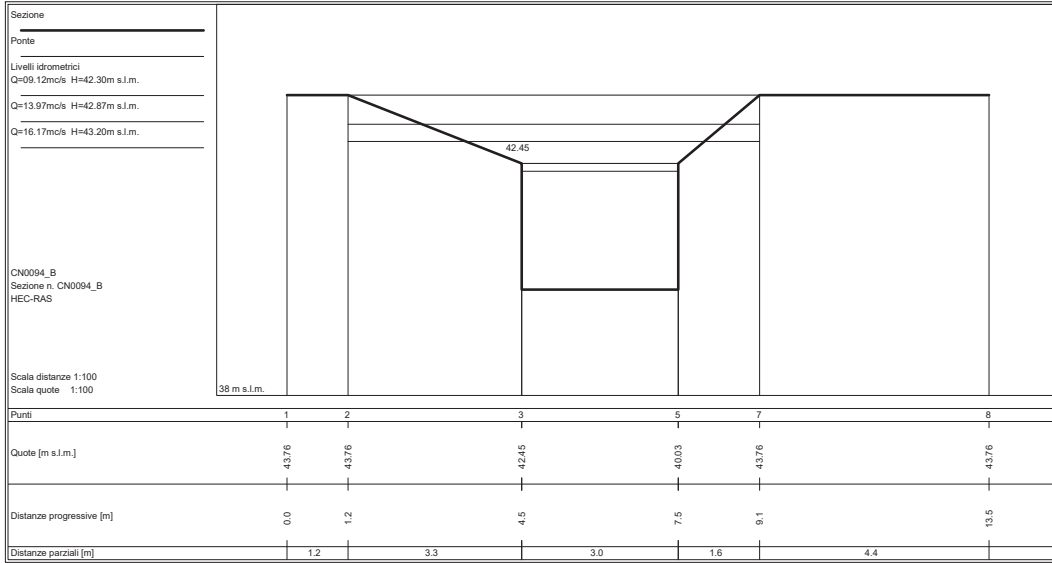

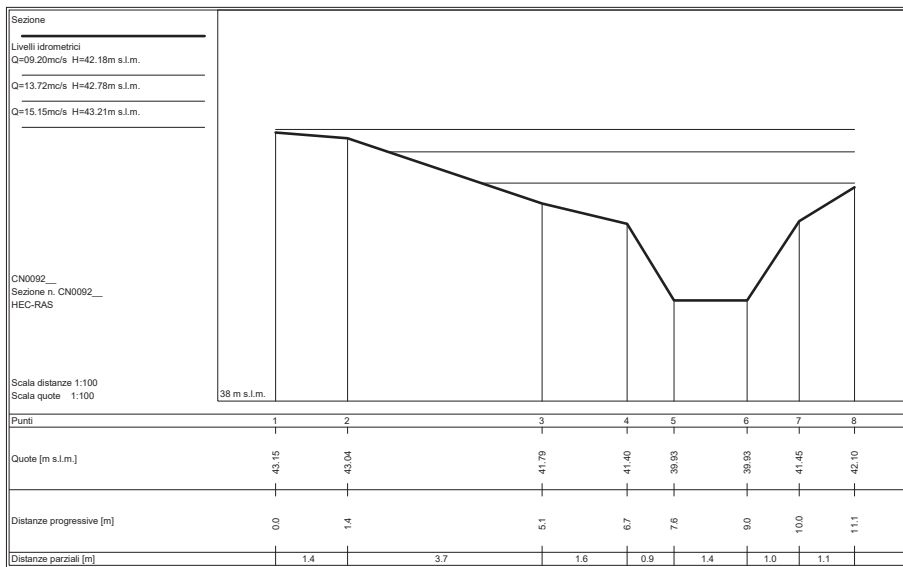
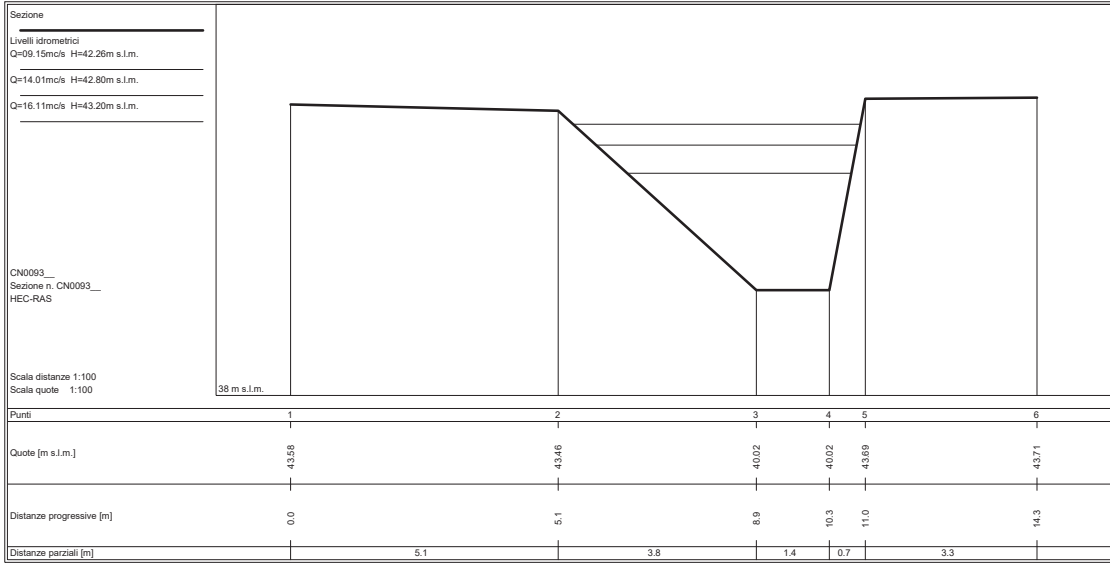

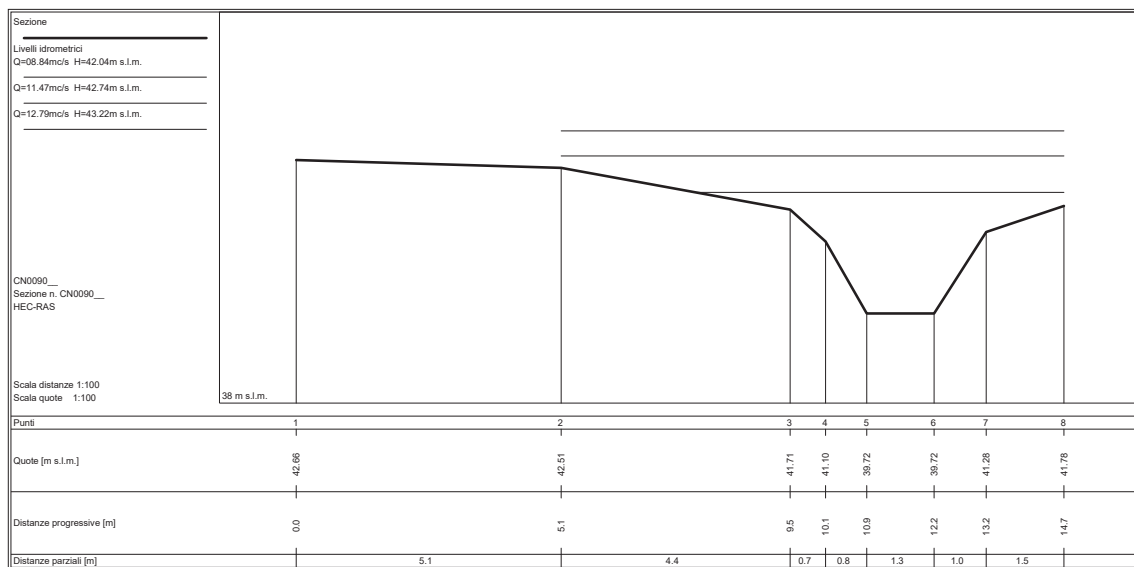
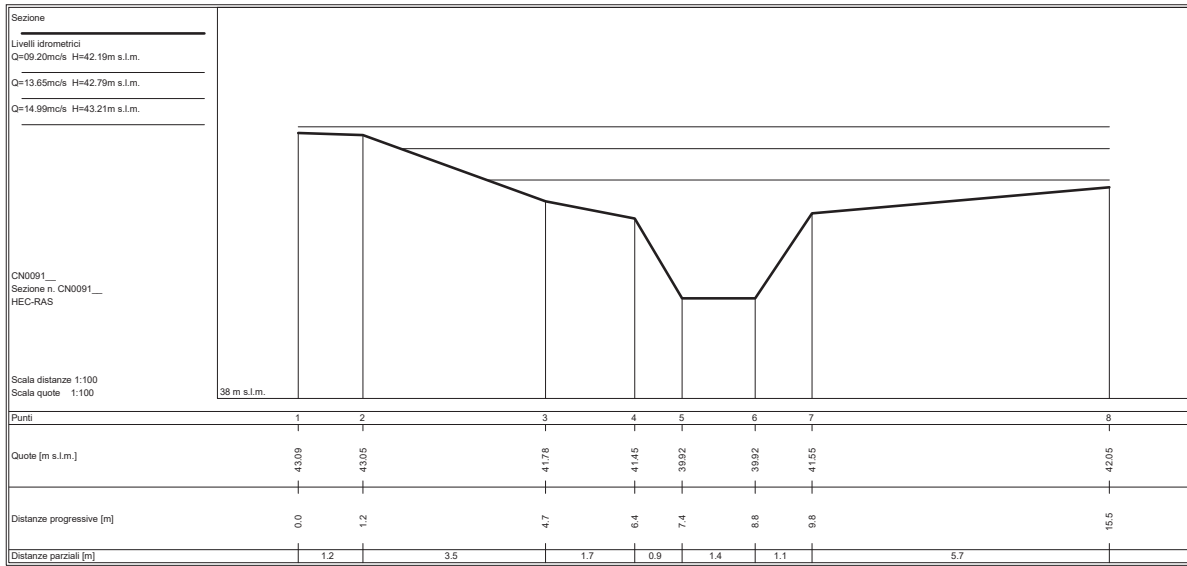

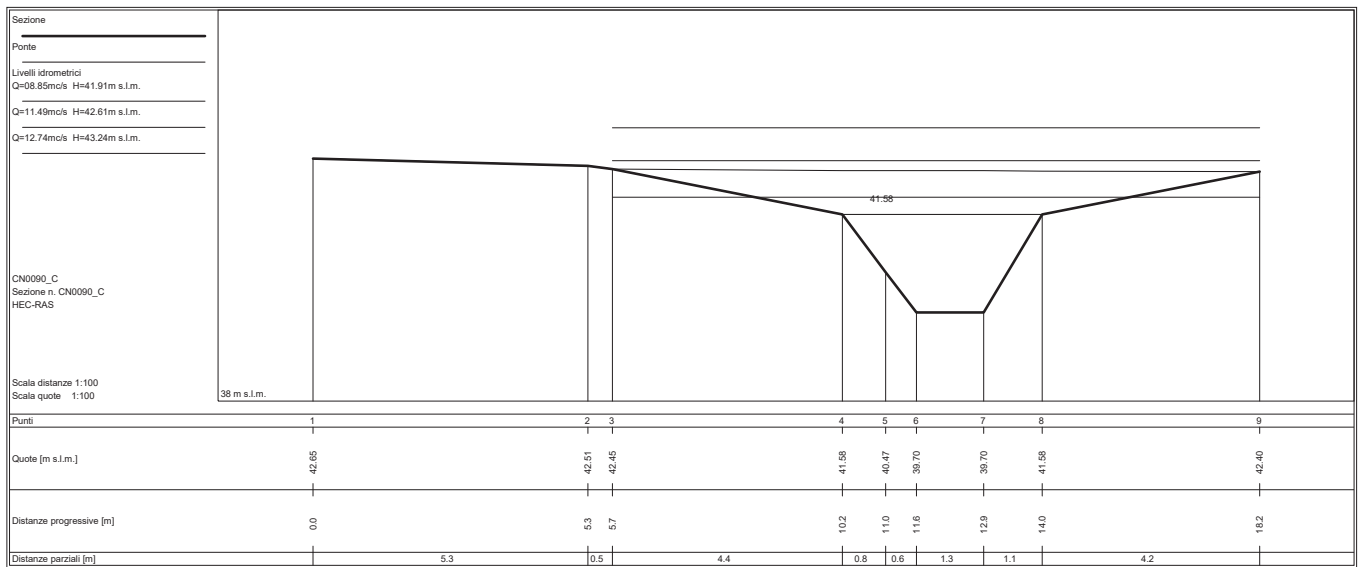
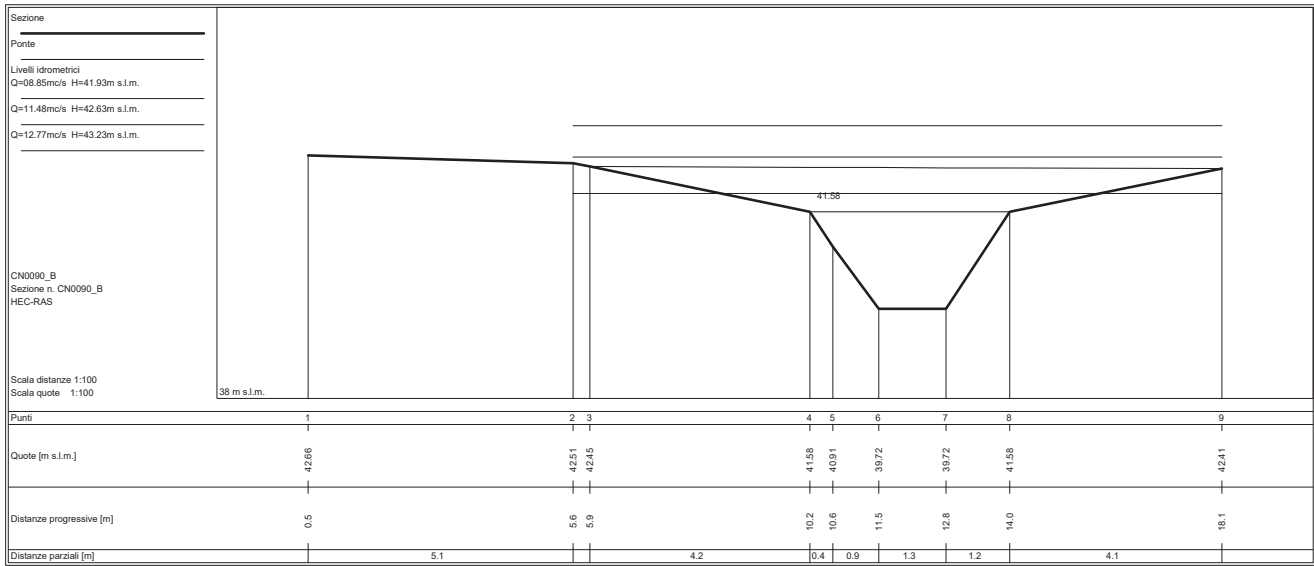



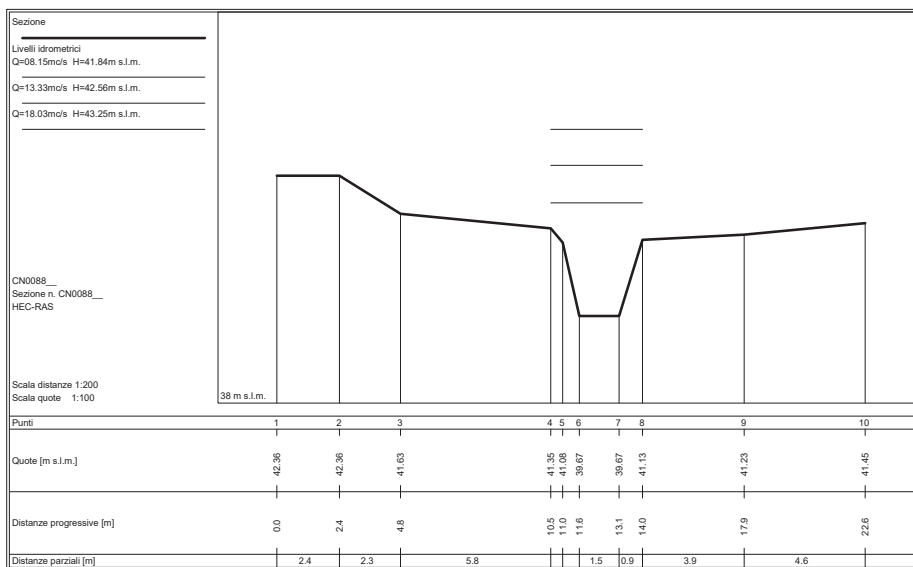
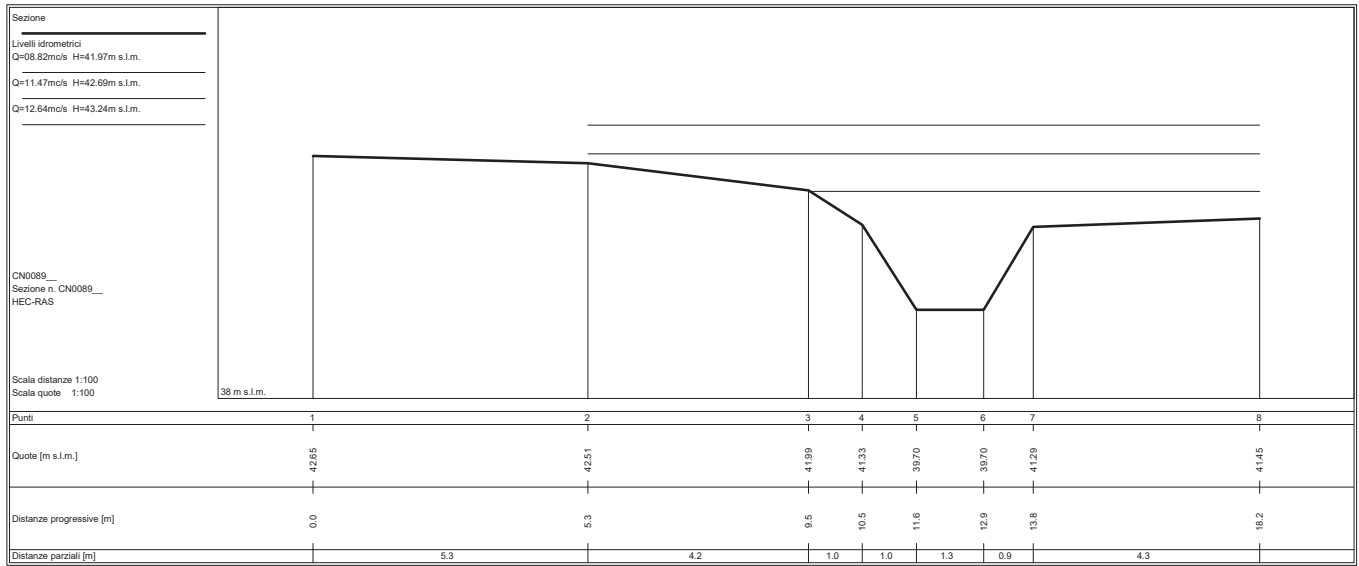

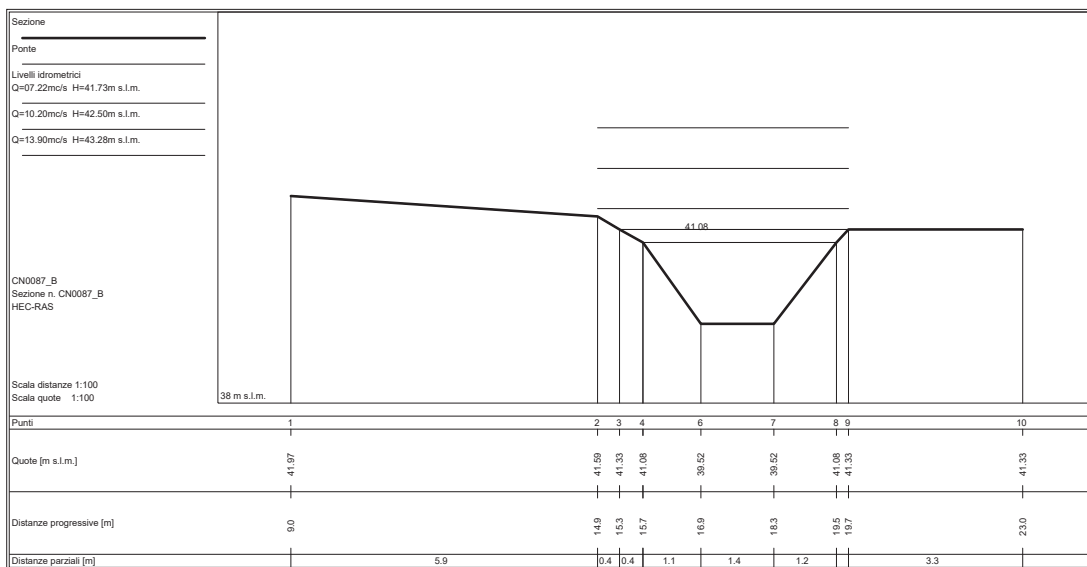
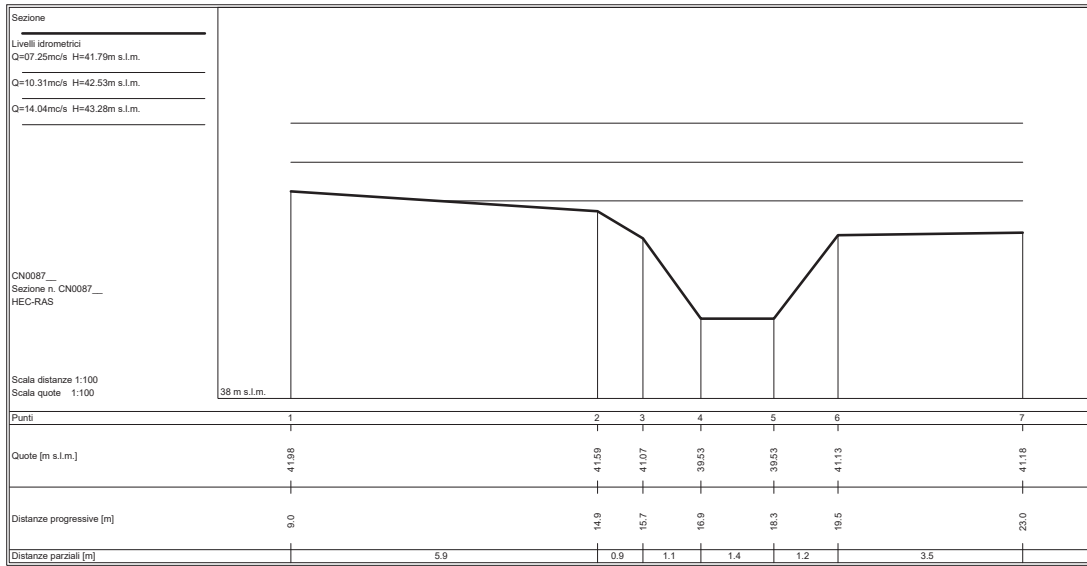

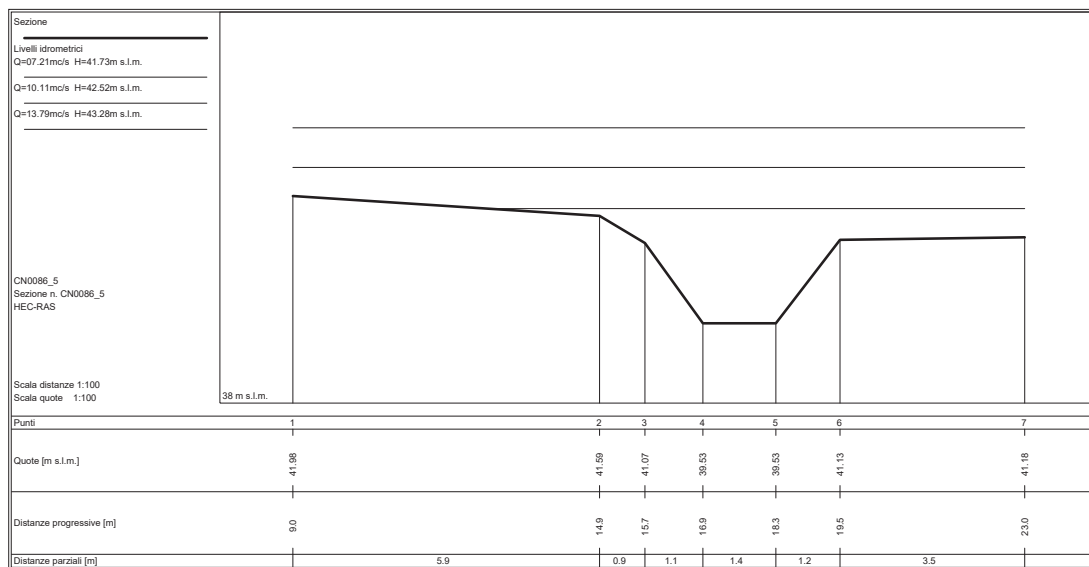
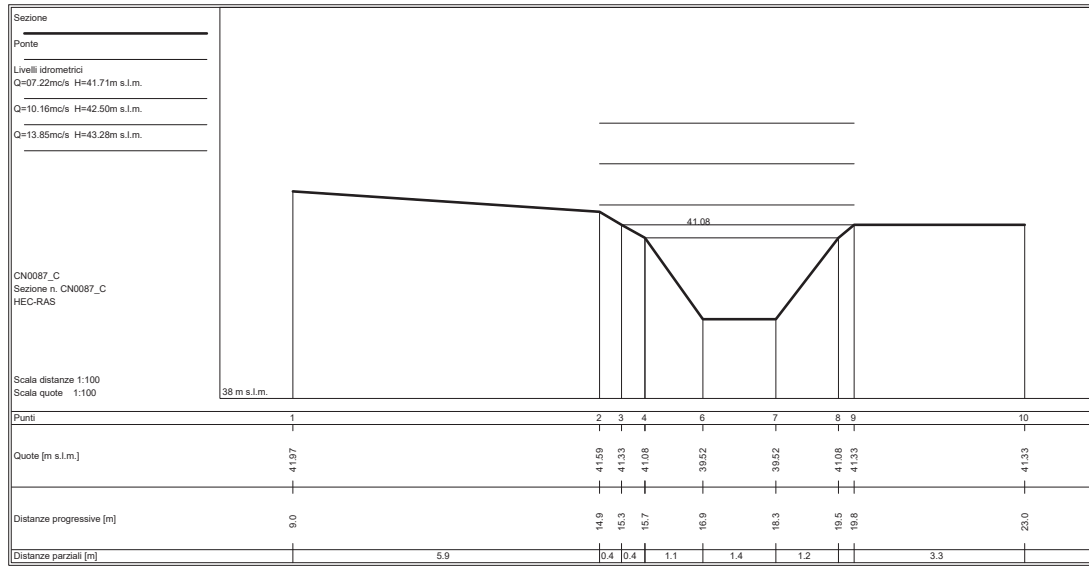

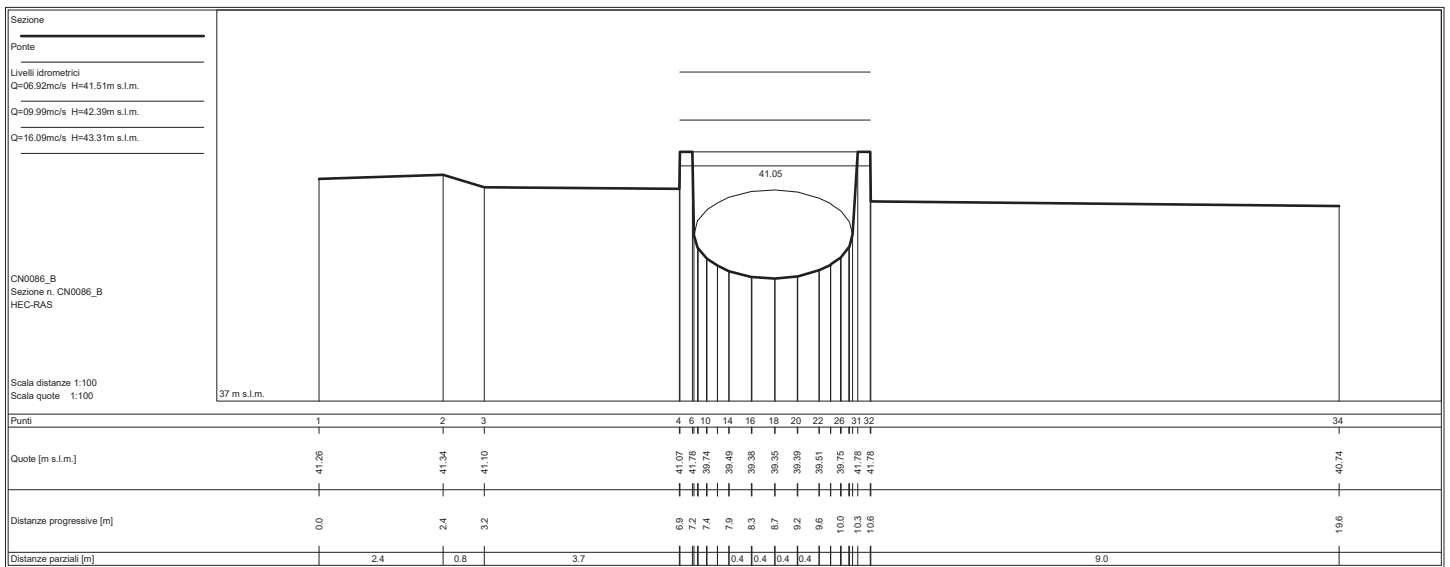
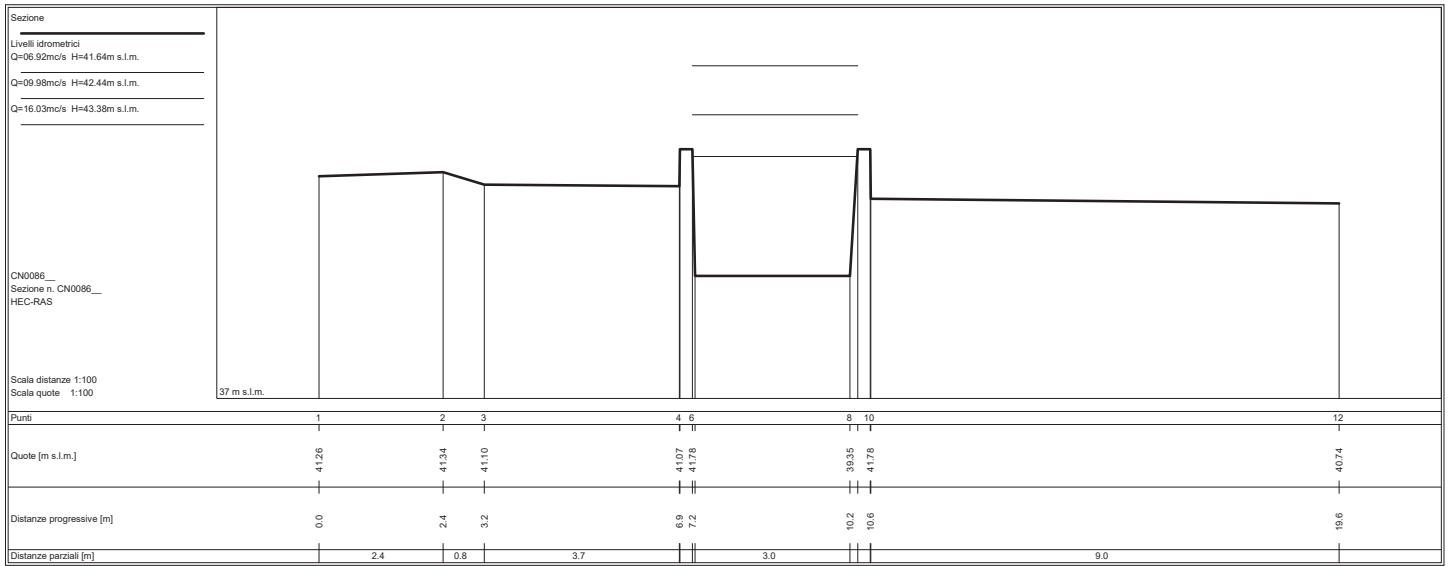

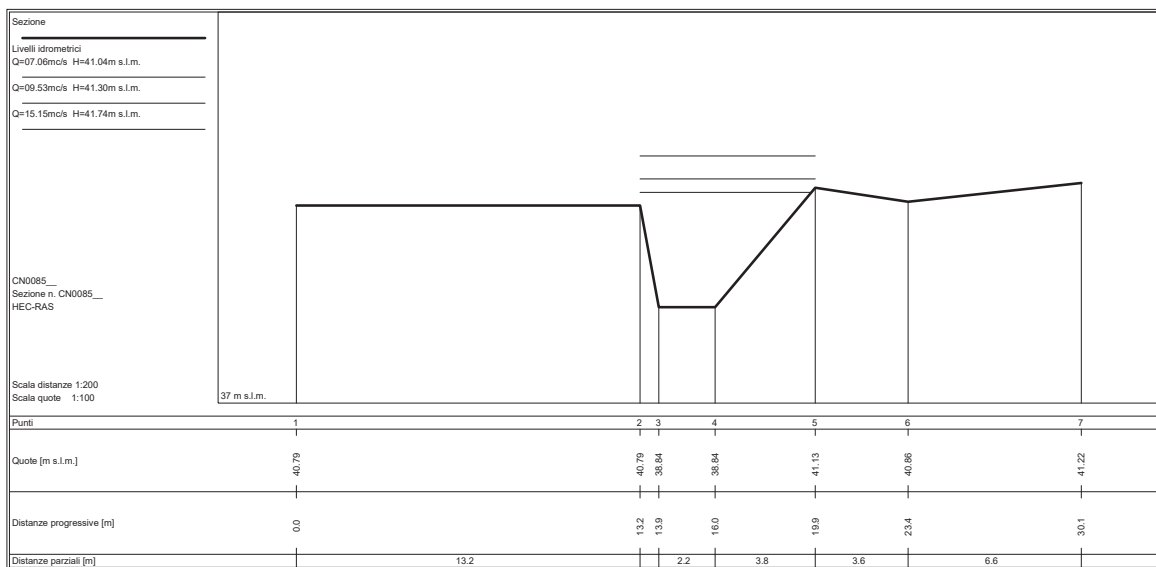
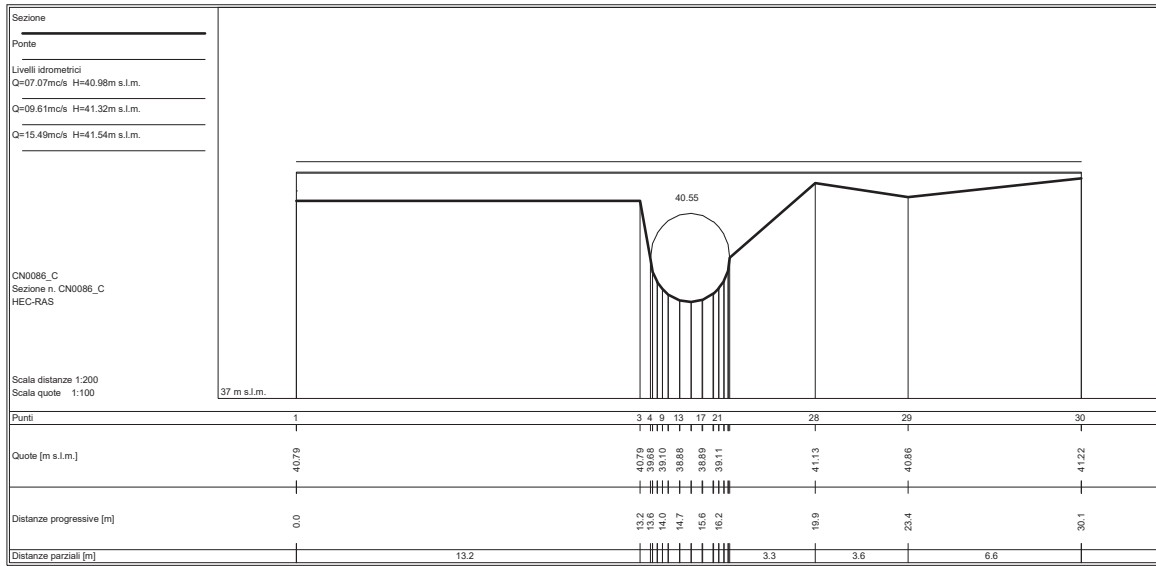

SEZIONI FLUVIALI  
FOSSO FICARELLO

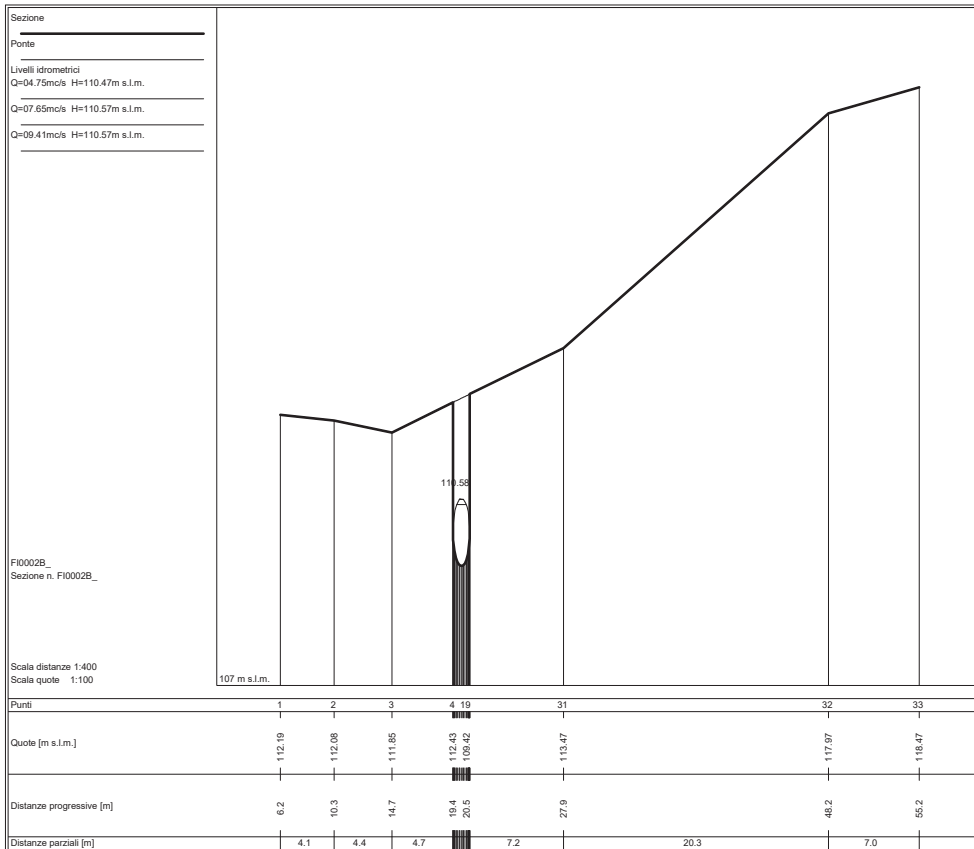
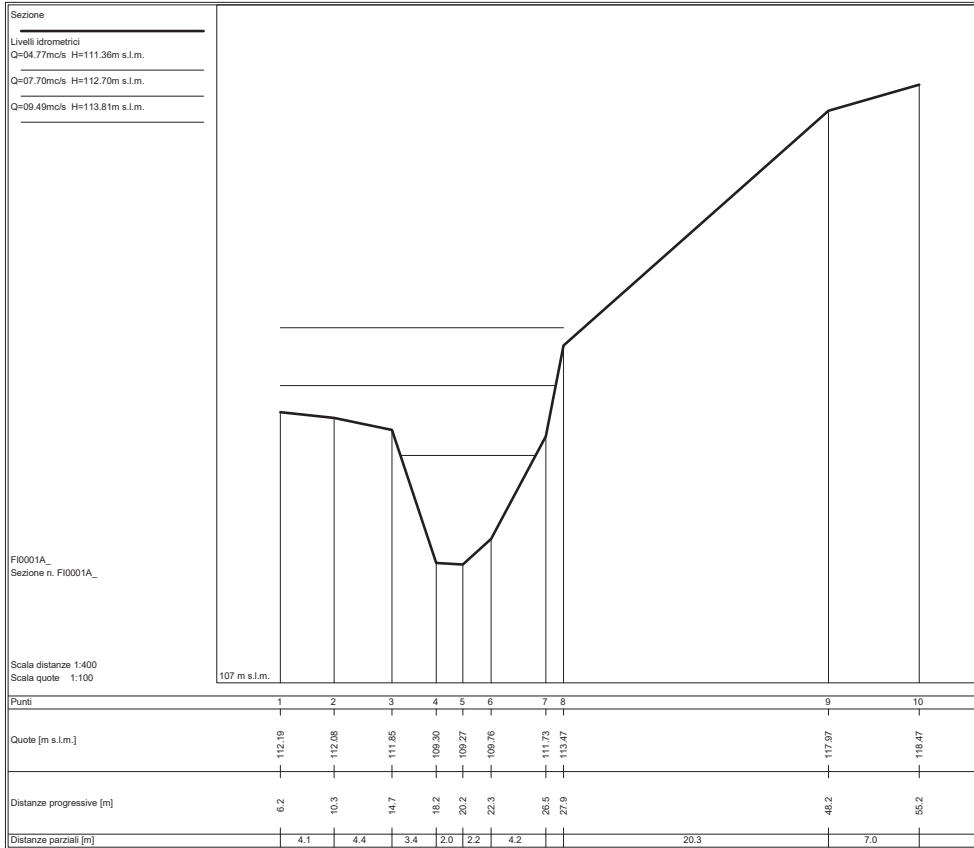

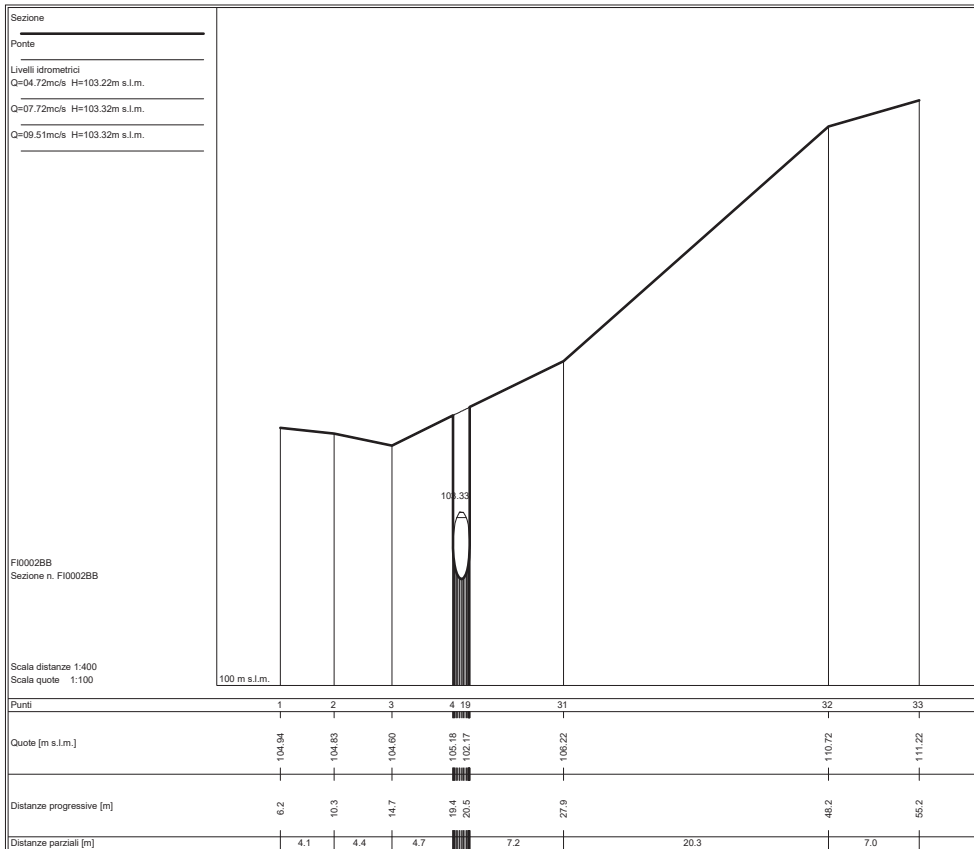
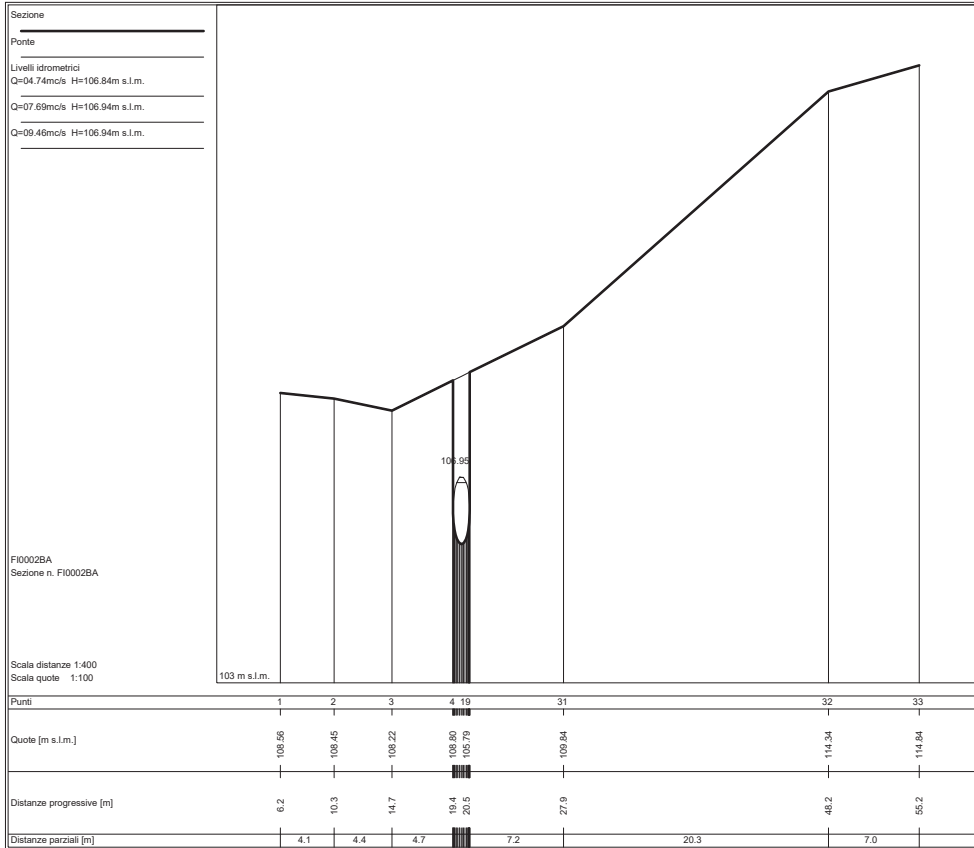



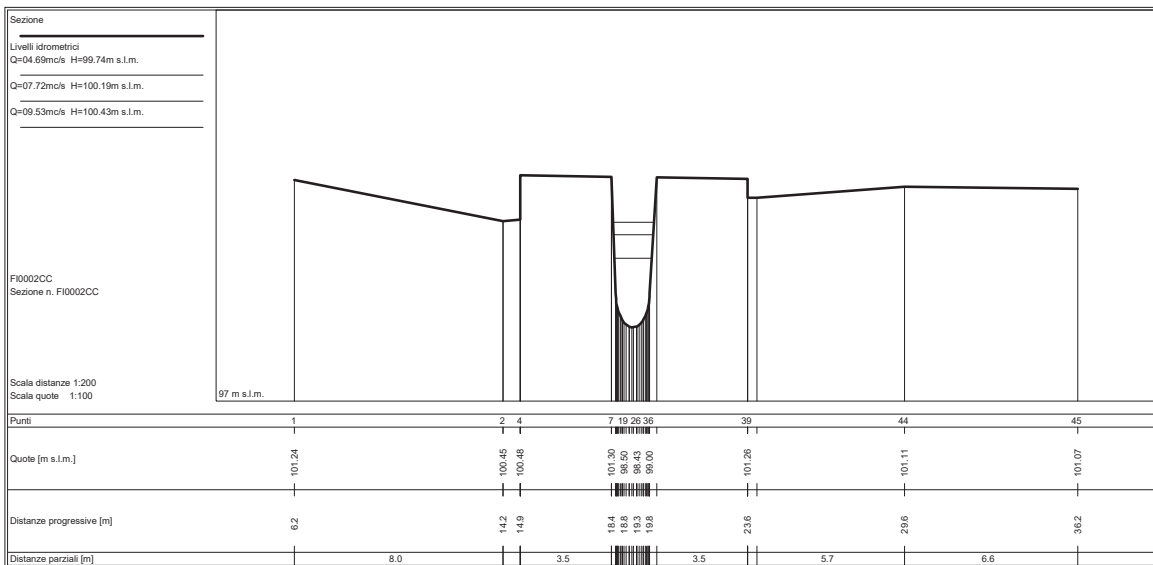
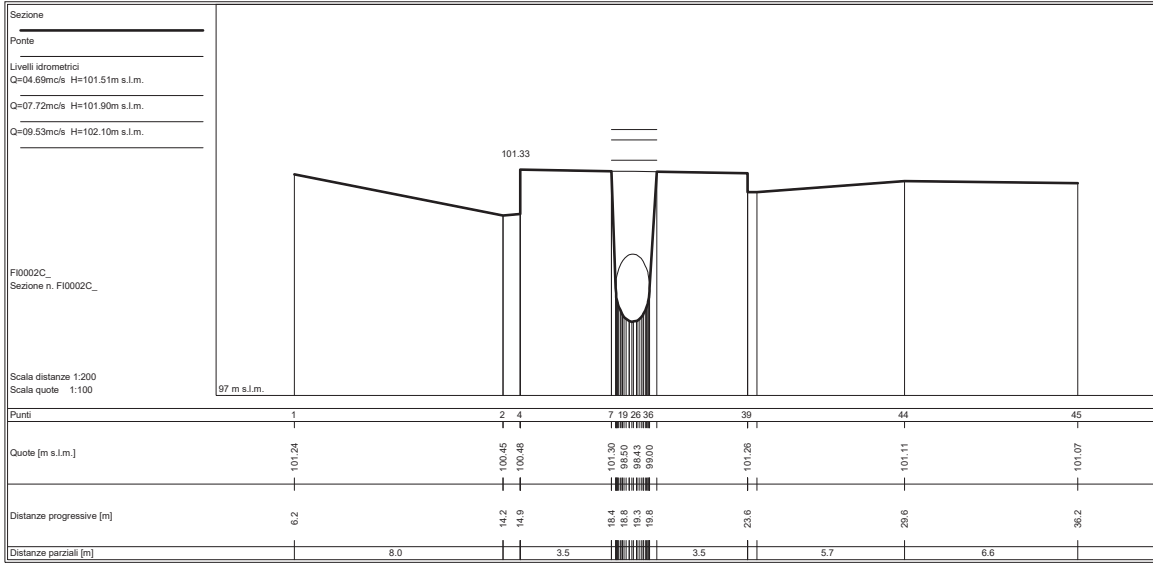

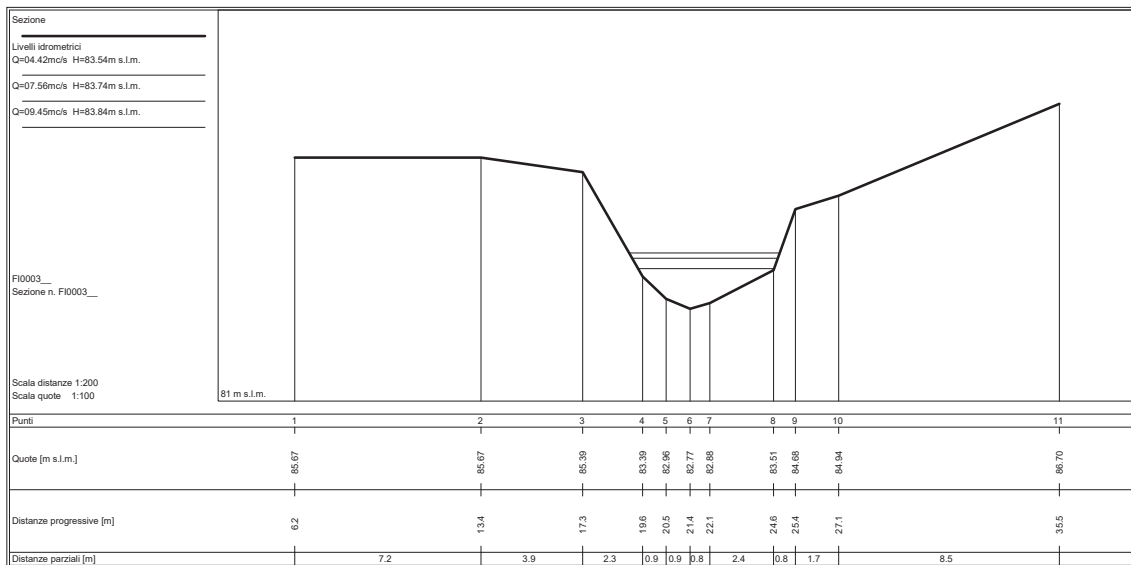
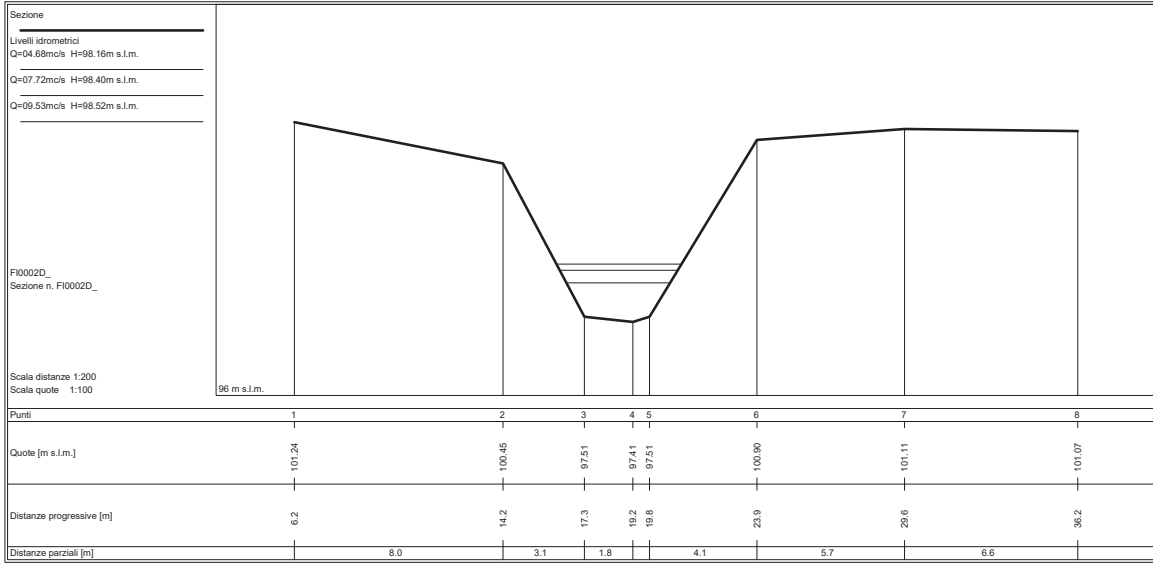

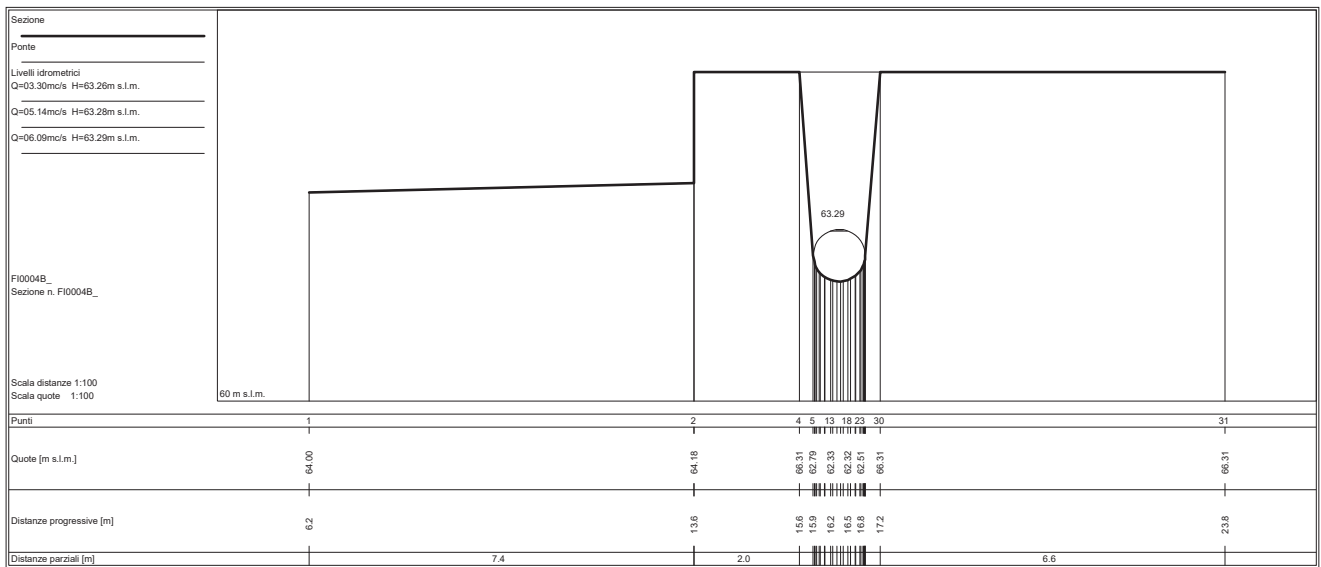
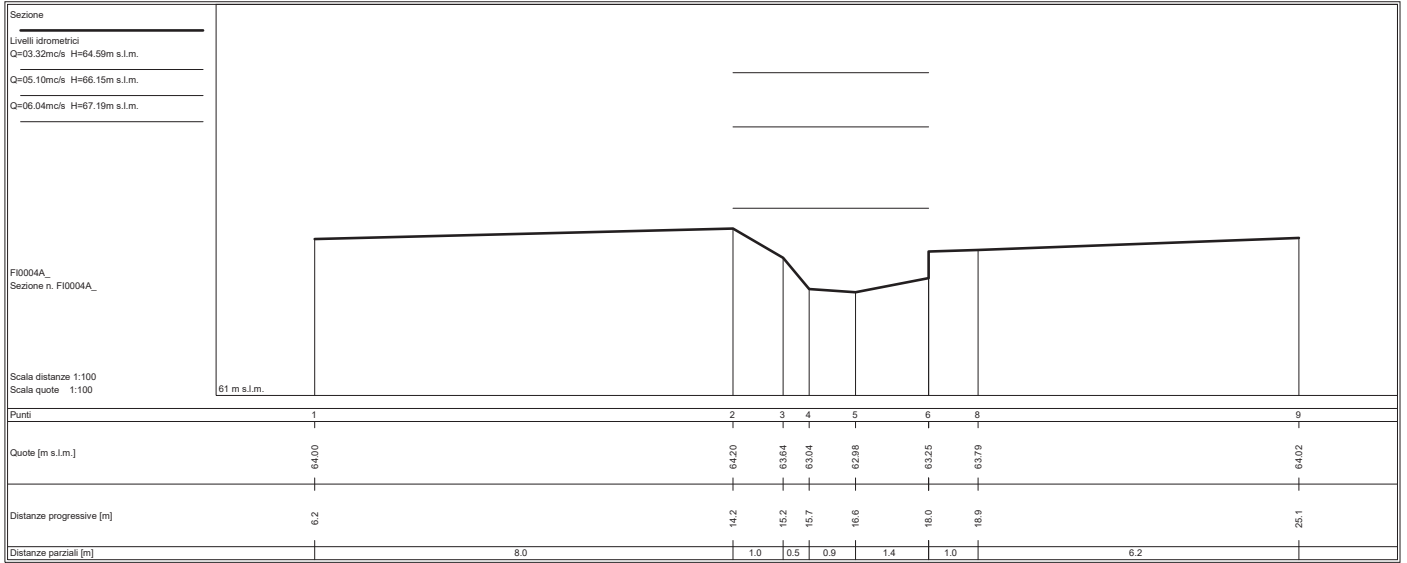

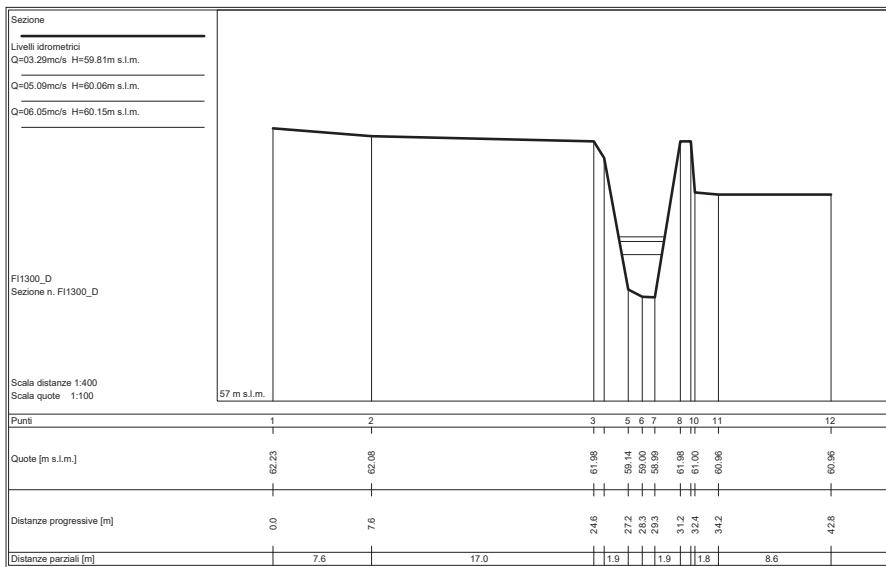
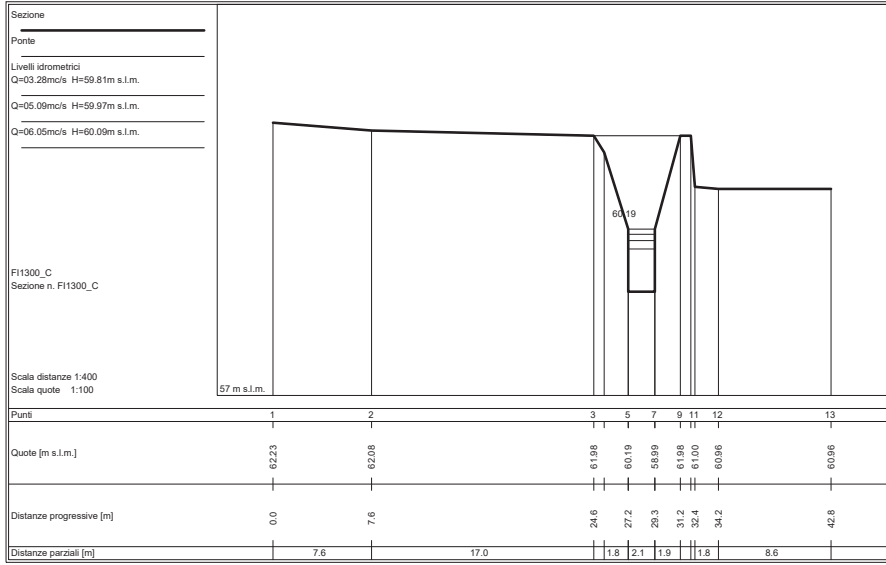

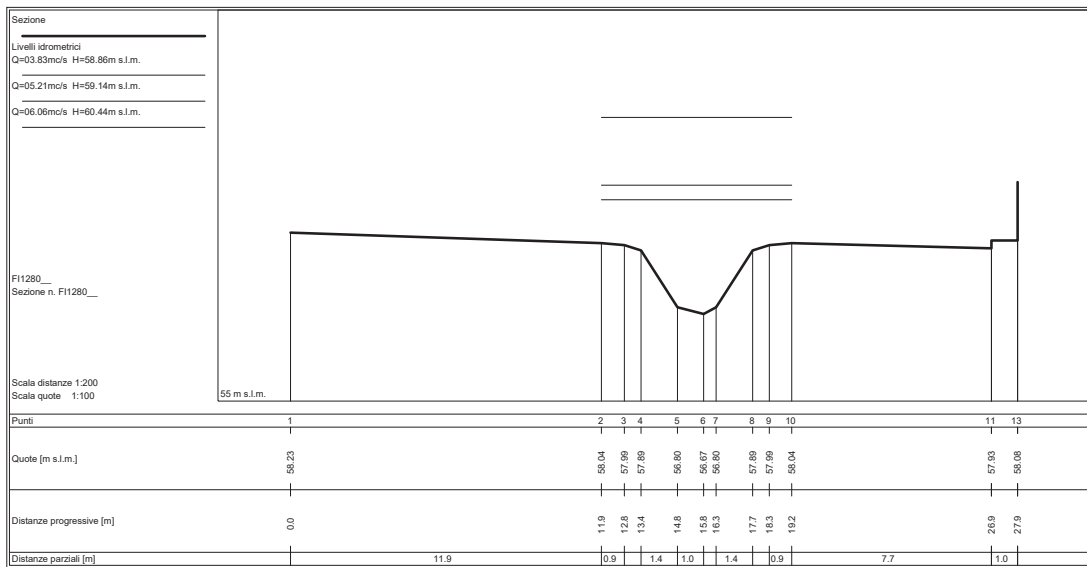
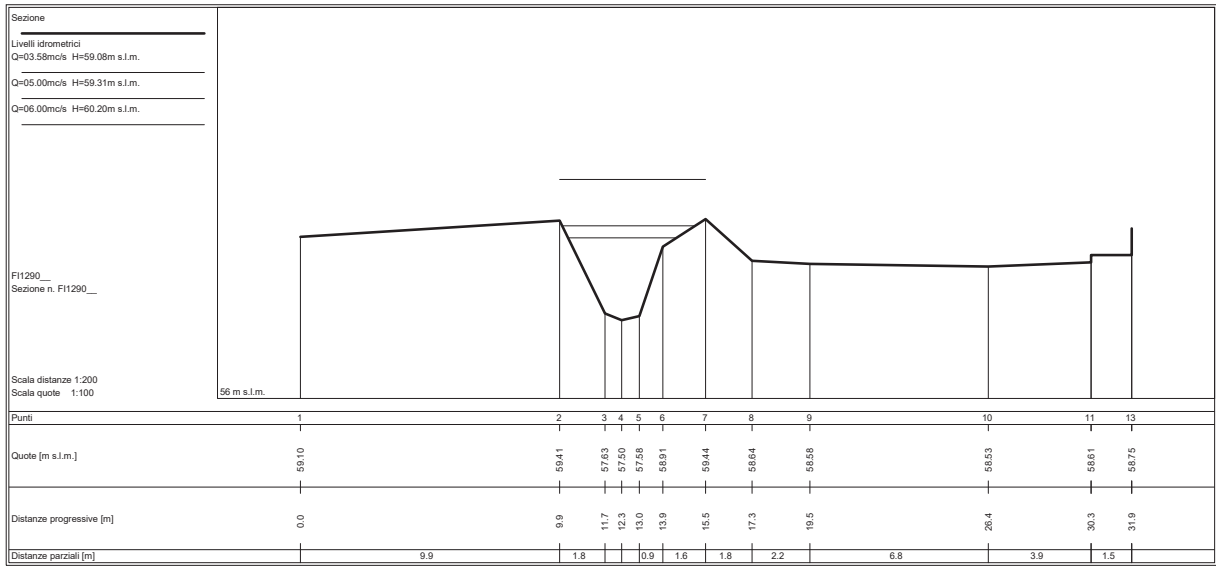

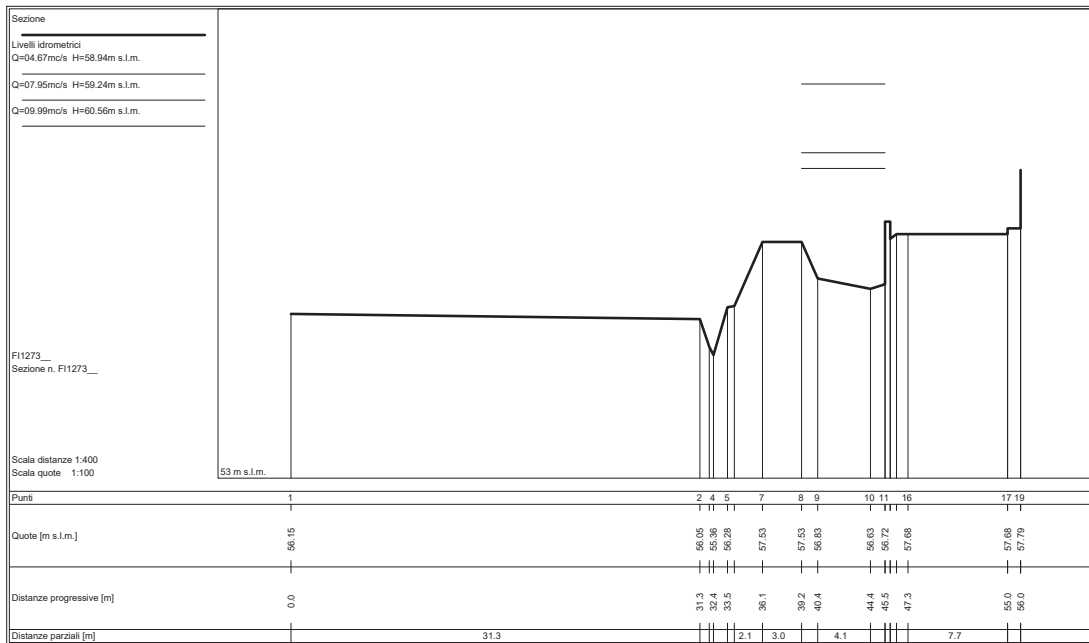
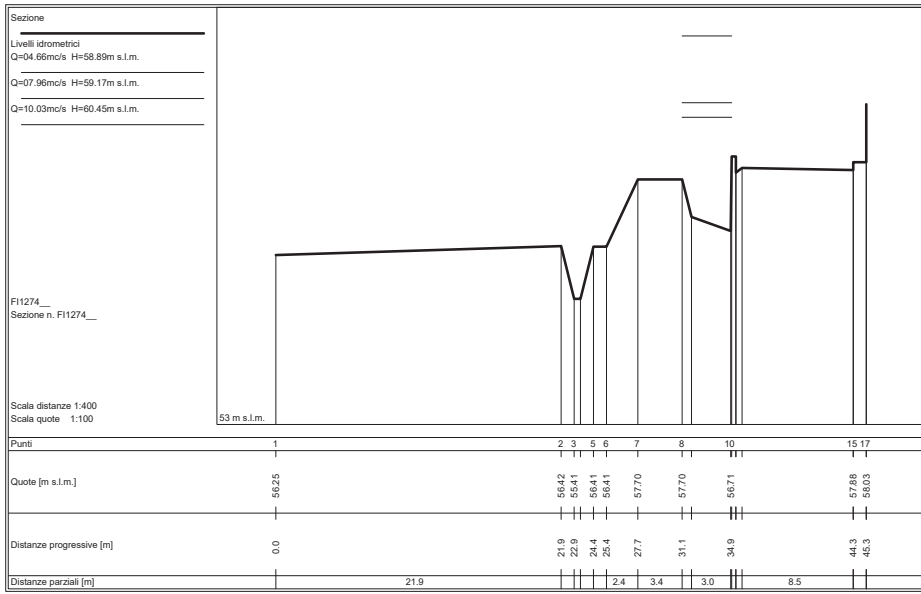

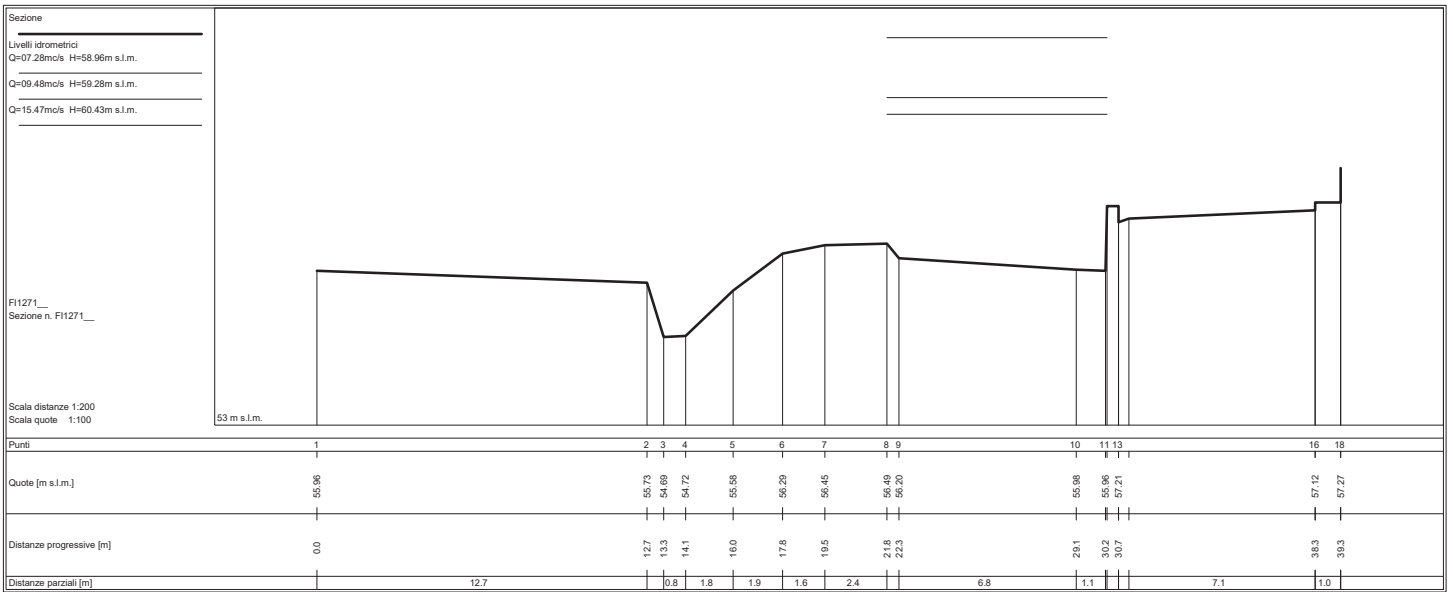
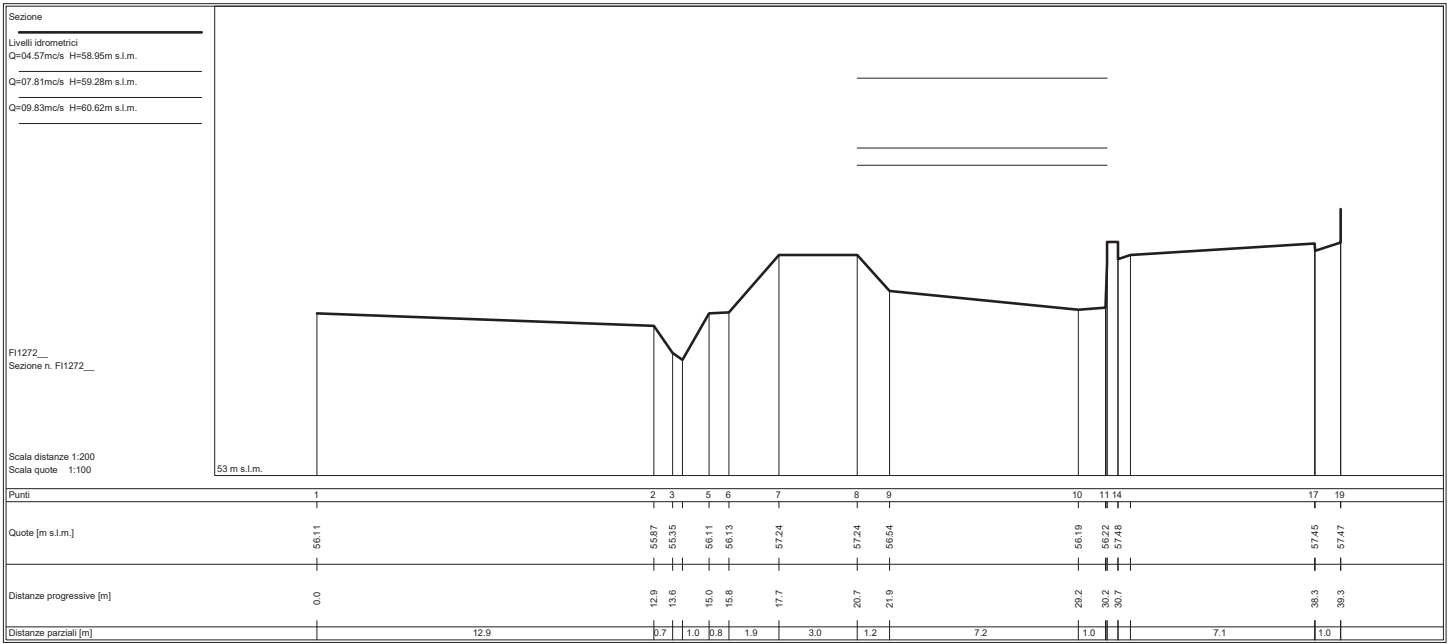

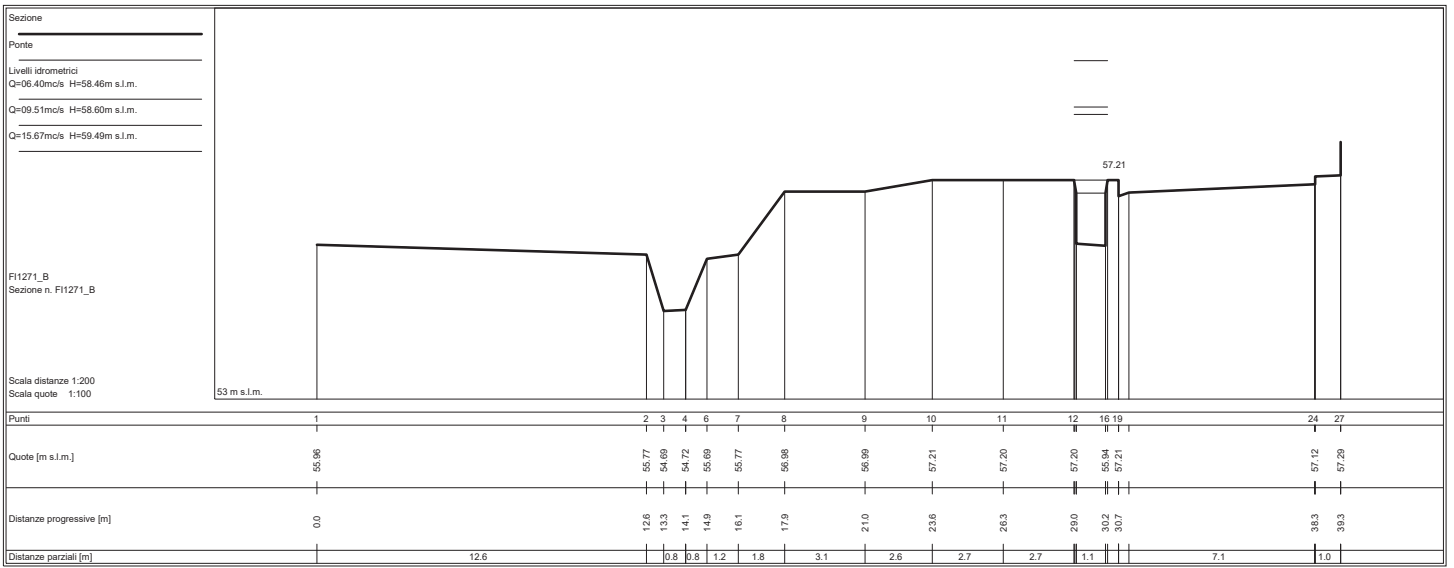
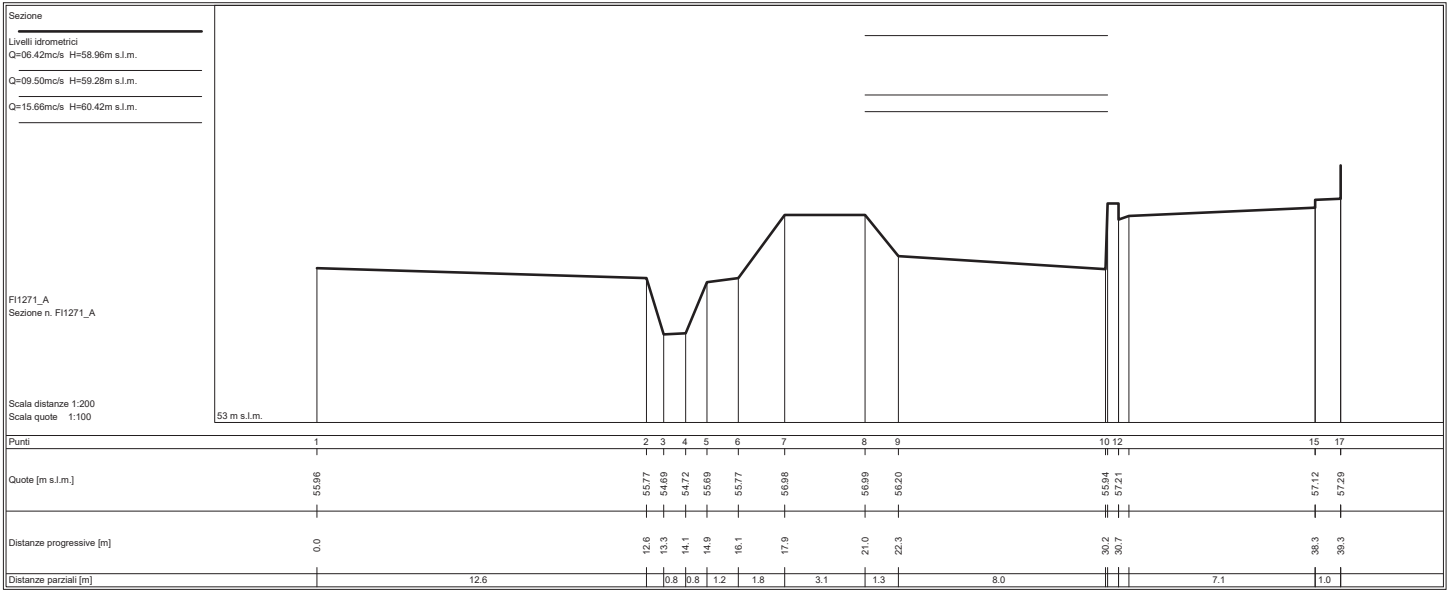



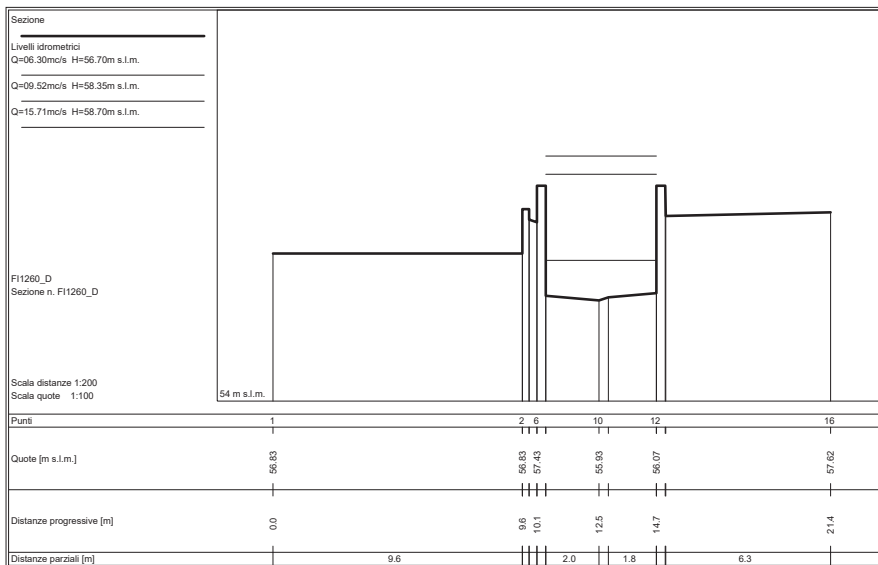
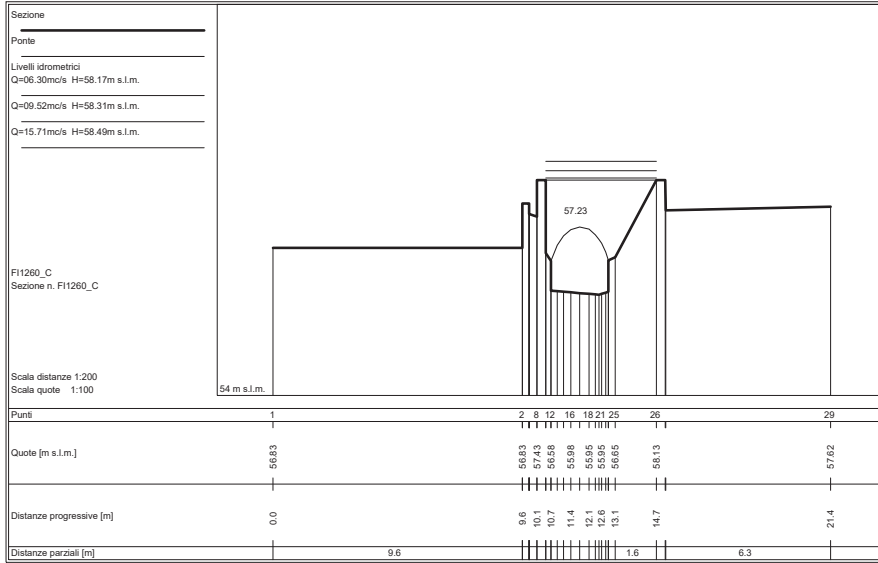

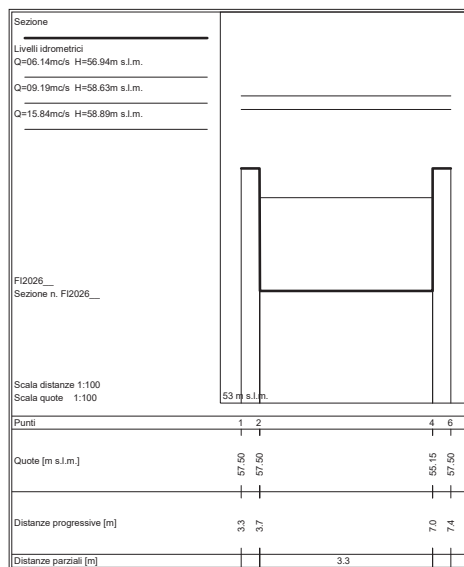
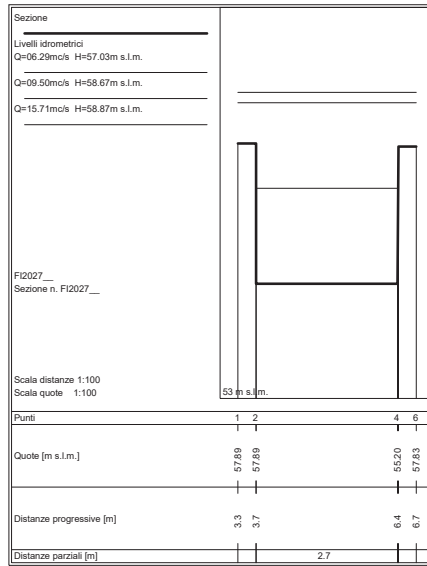

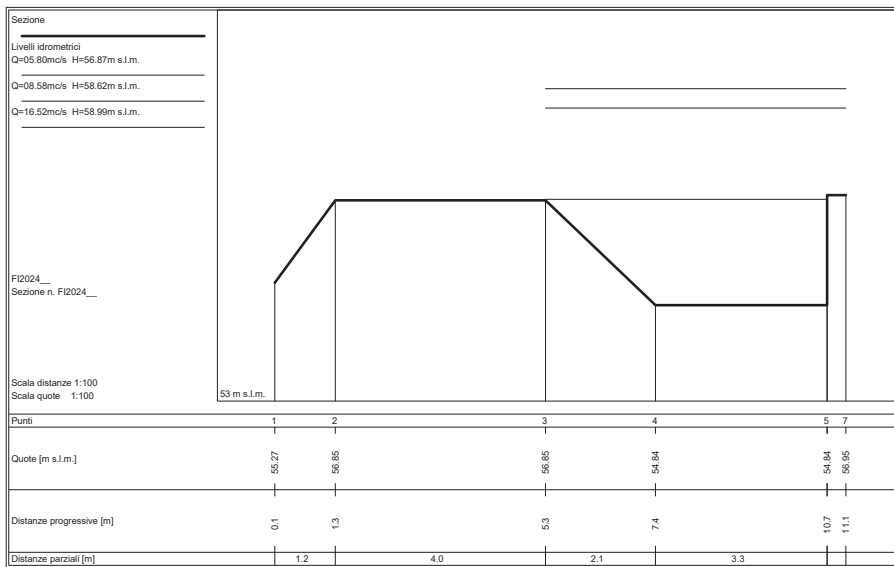
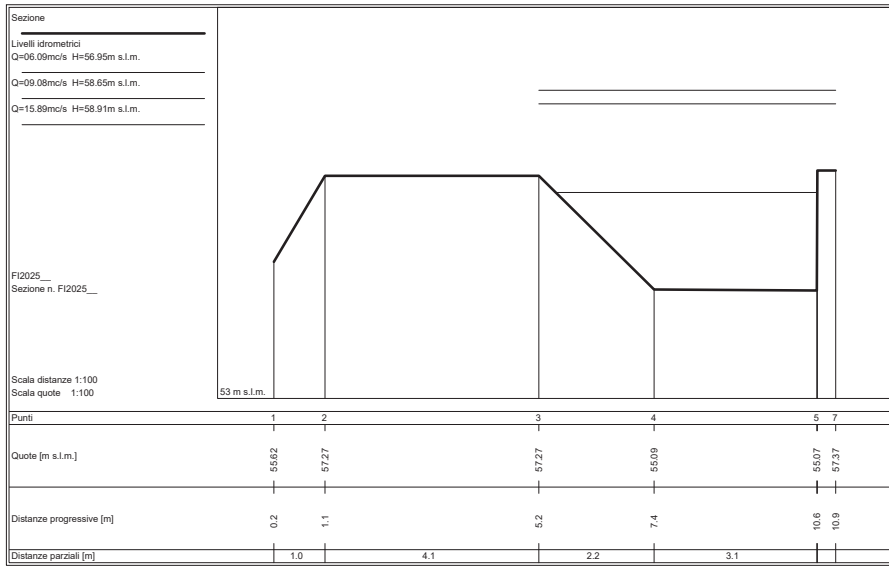

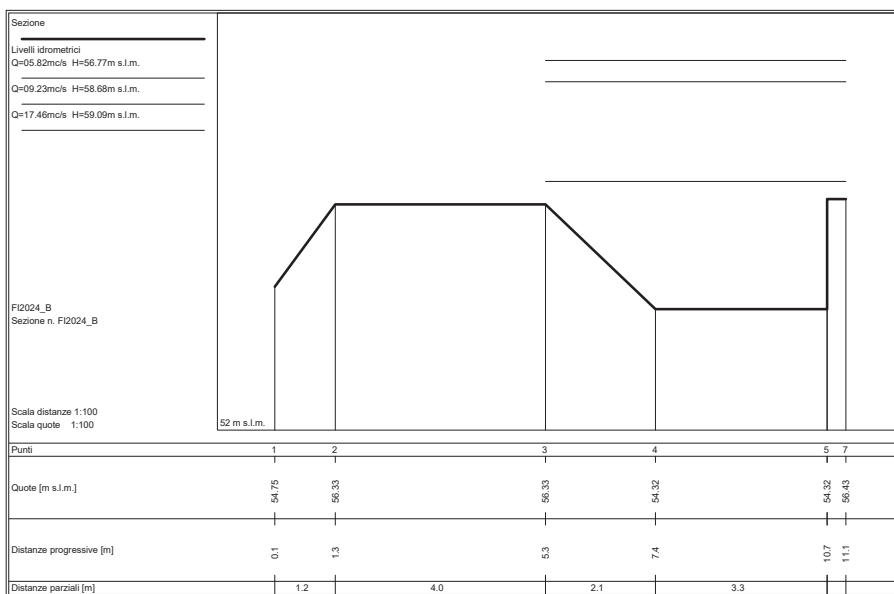
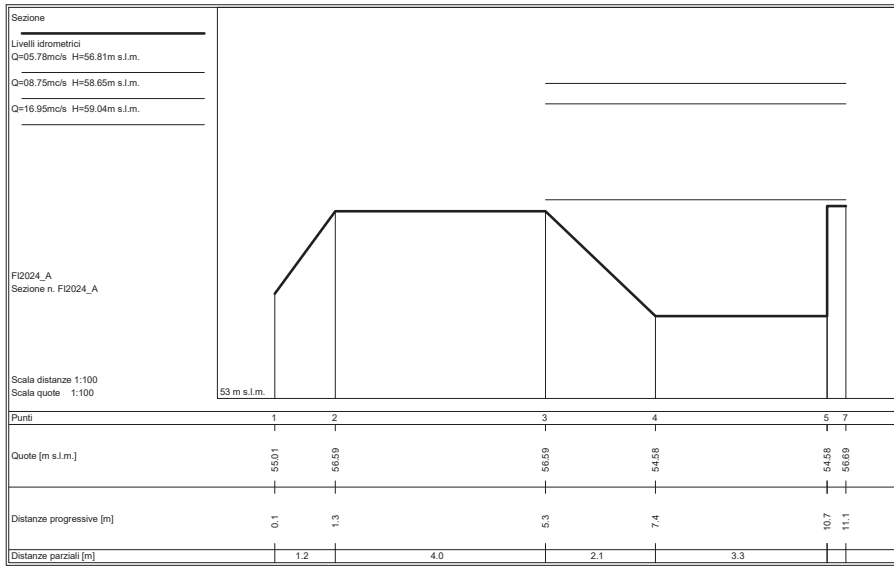

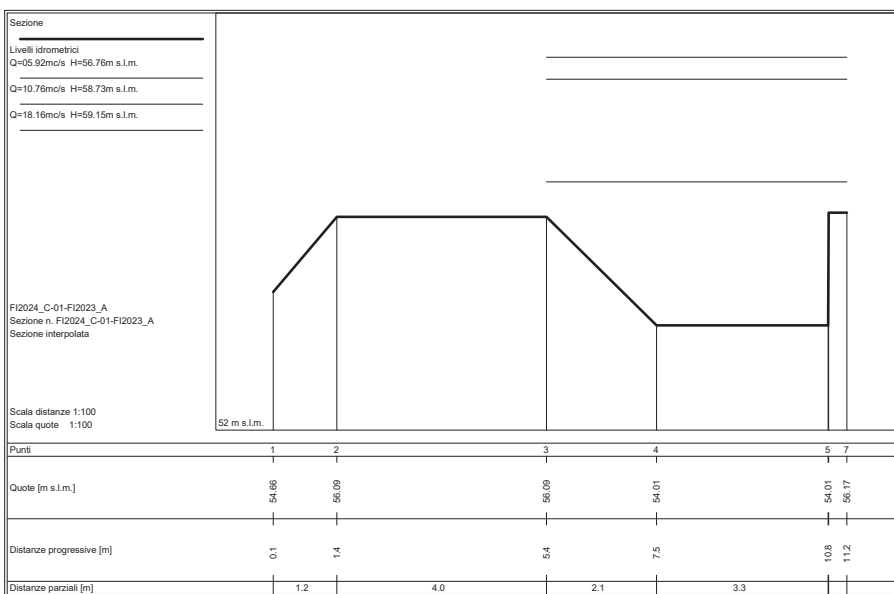
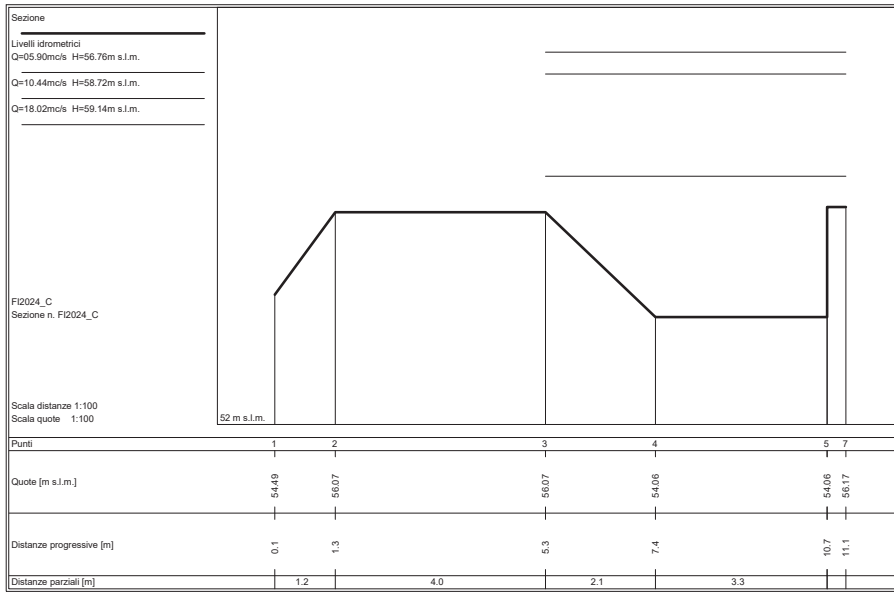

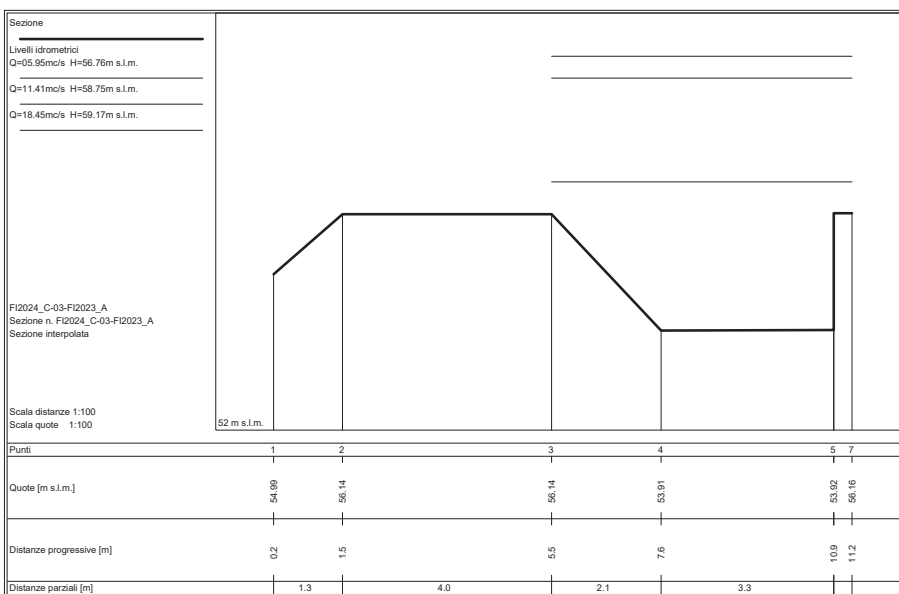
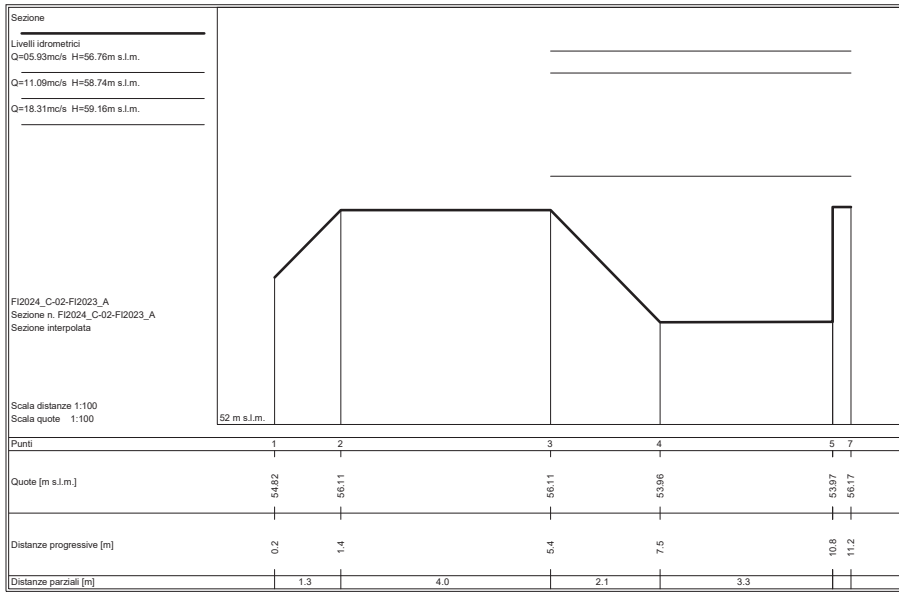

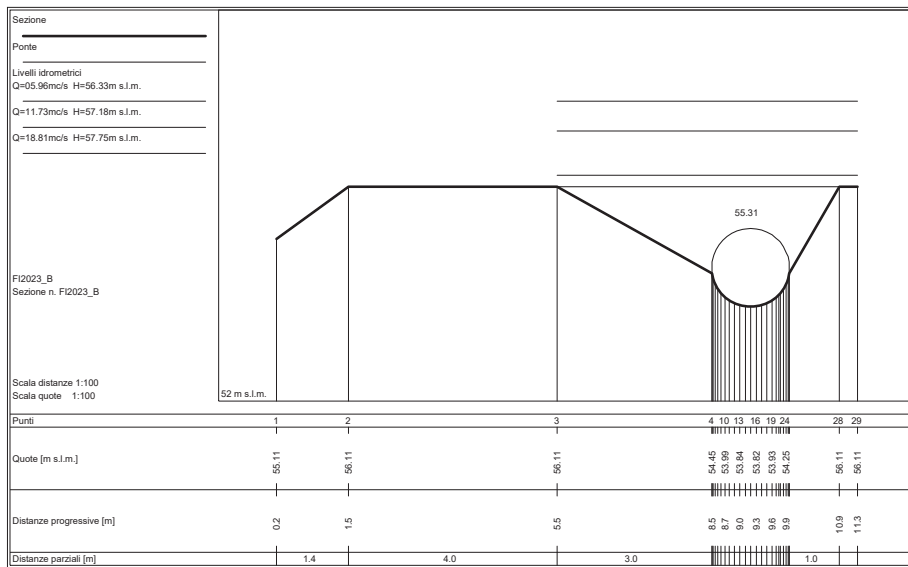
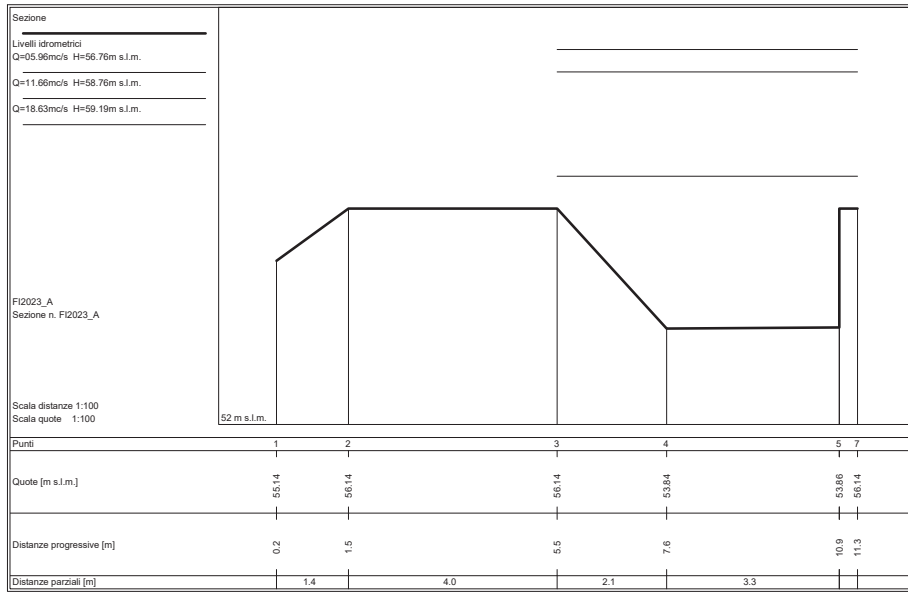

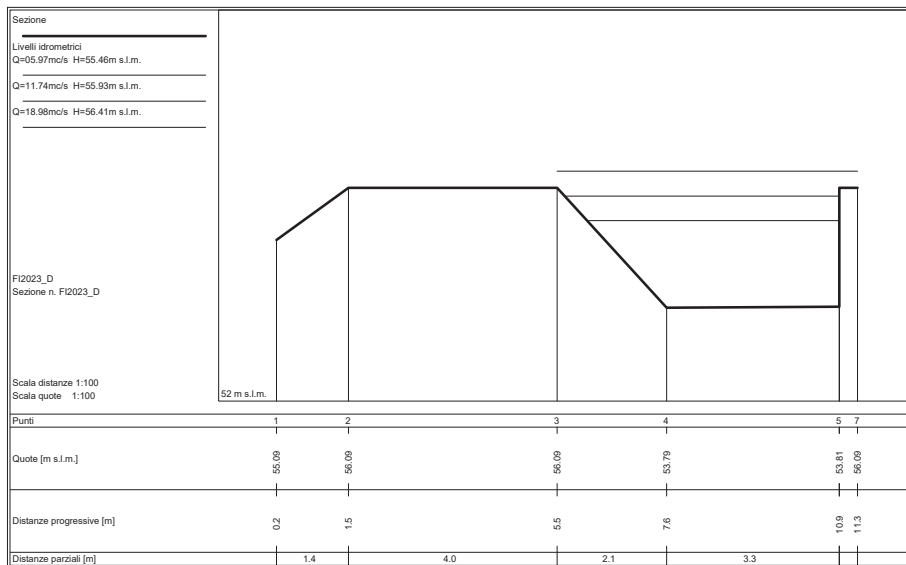
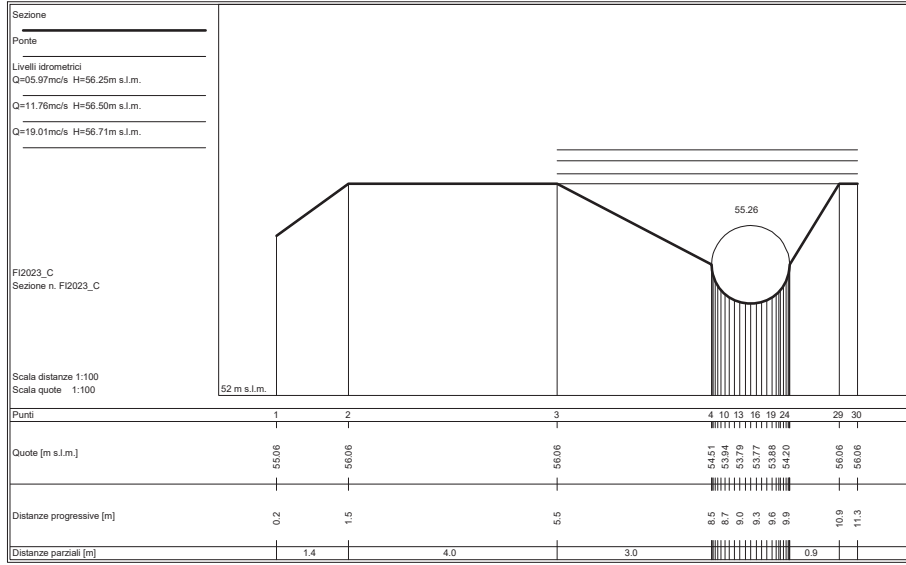



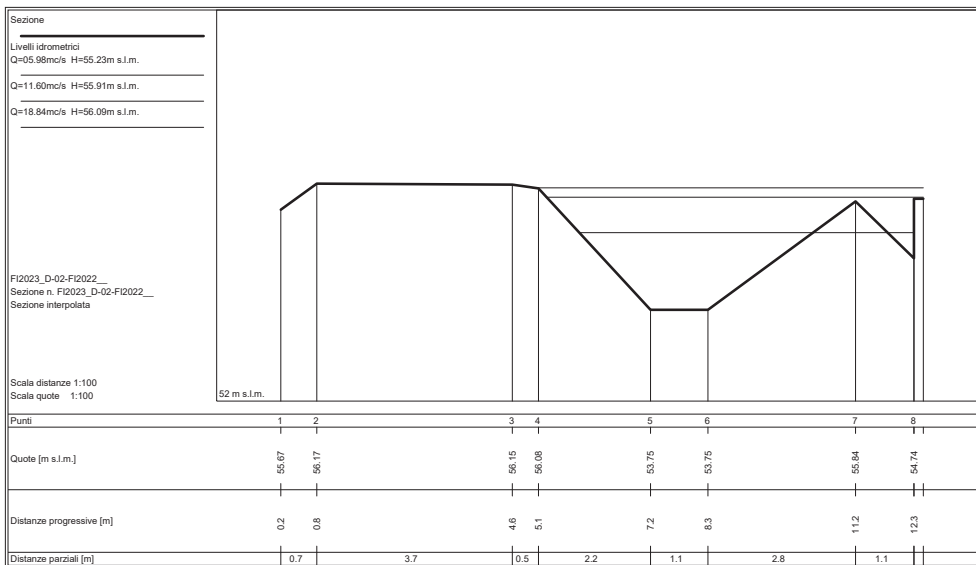
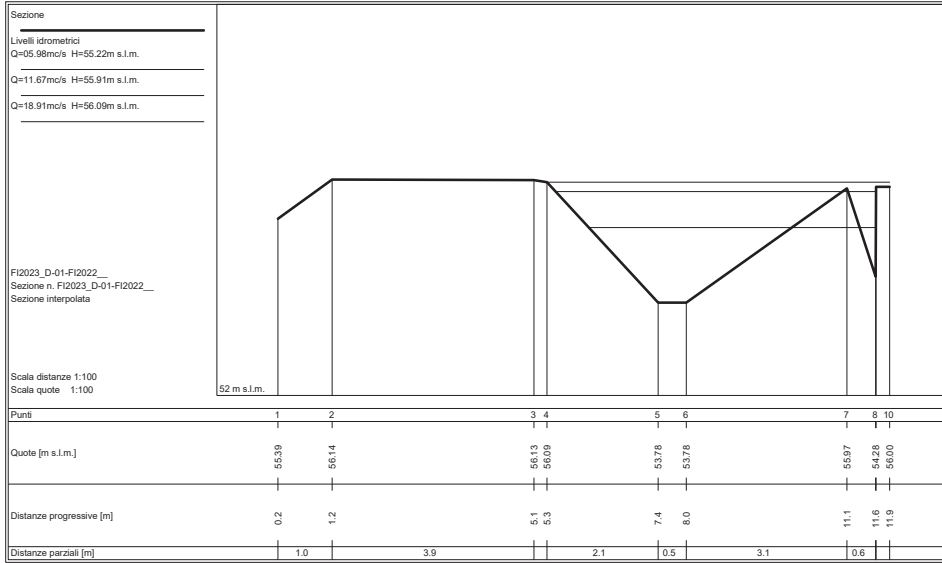

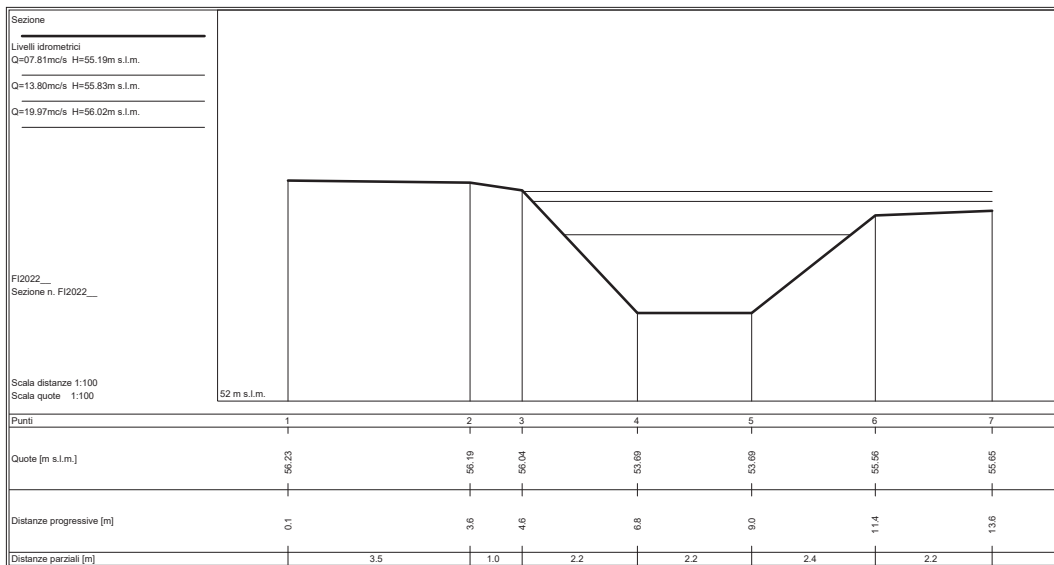
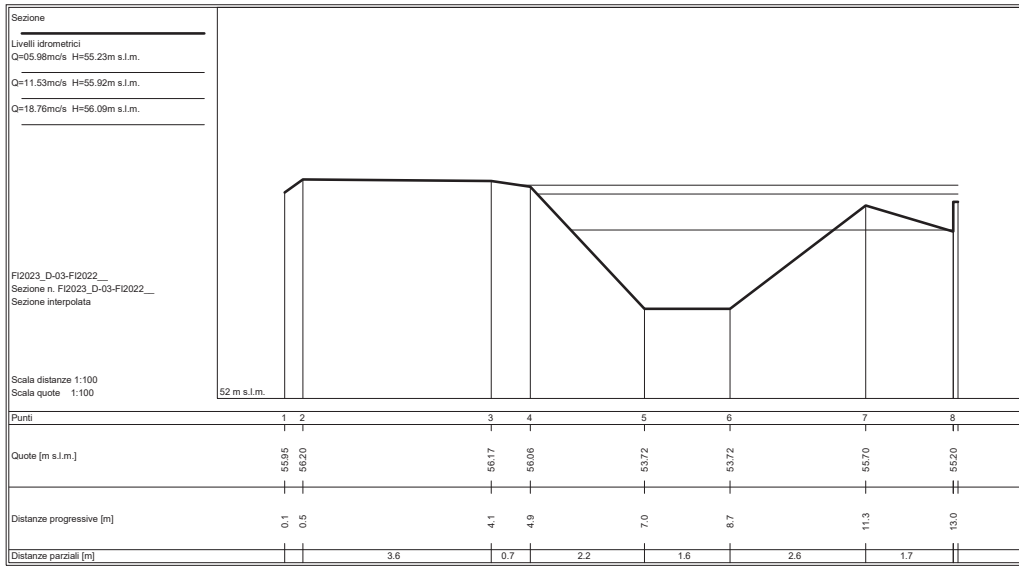

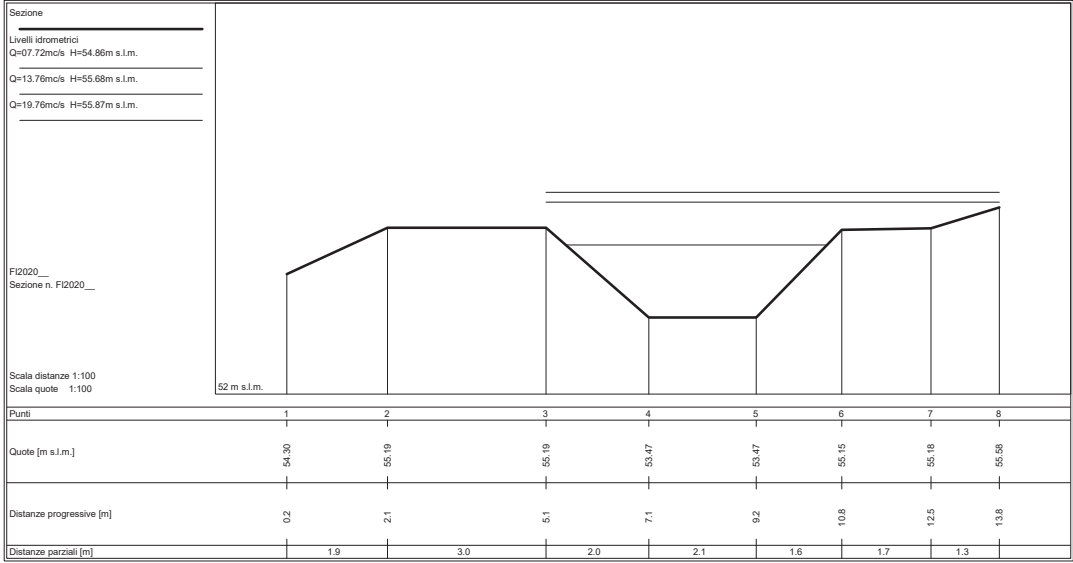
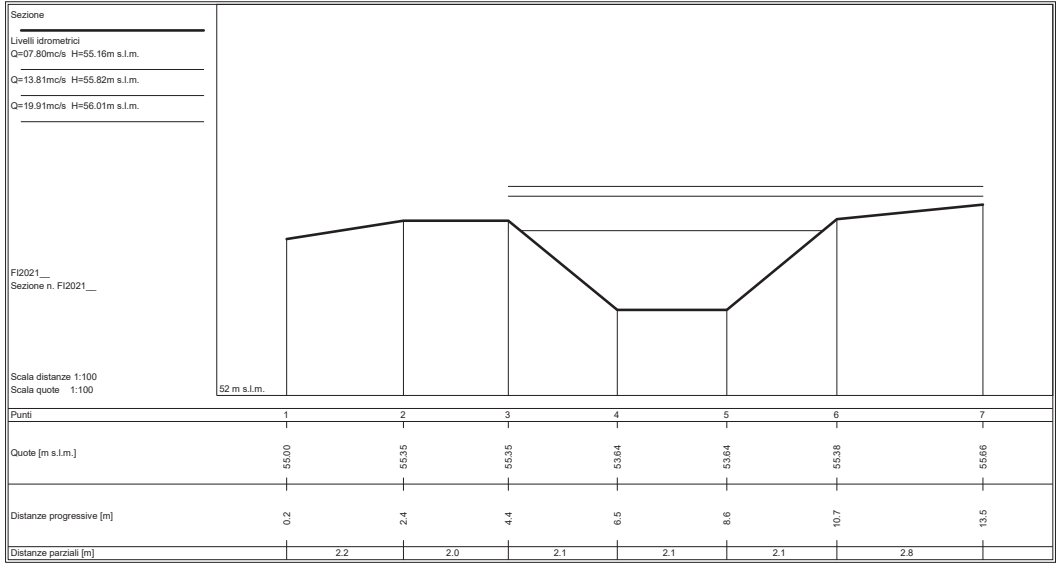

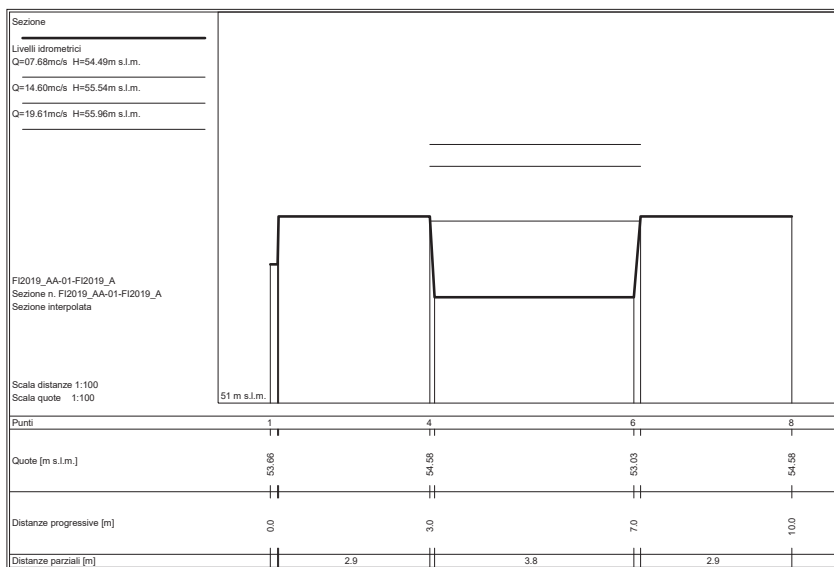
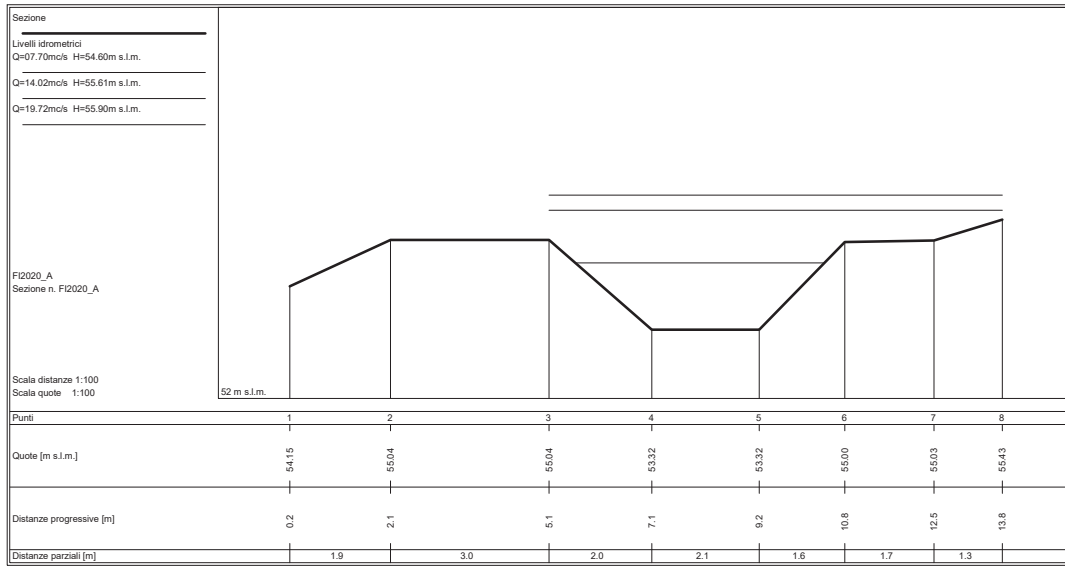

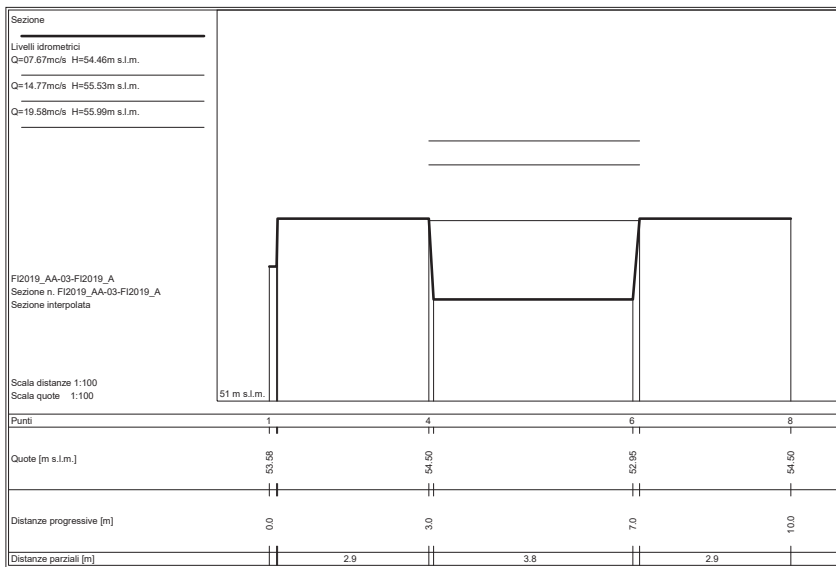
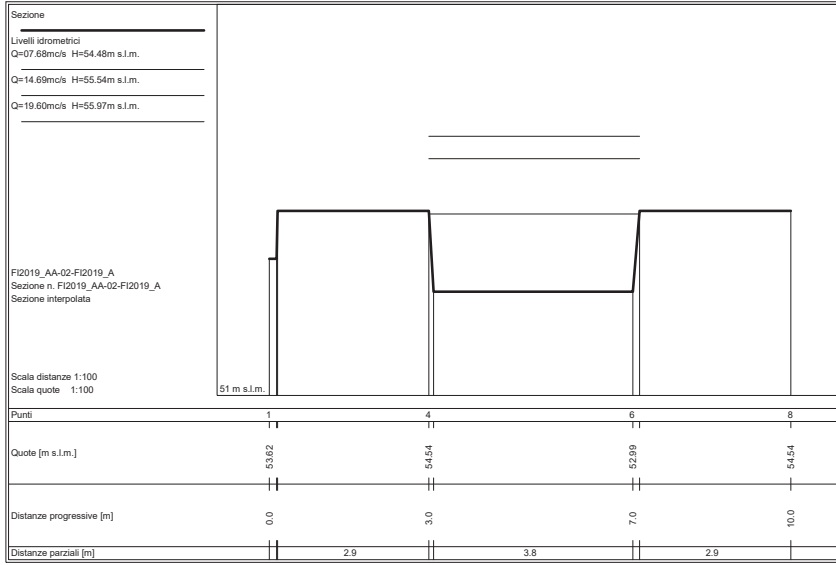

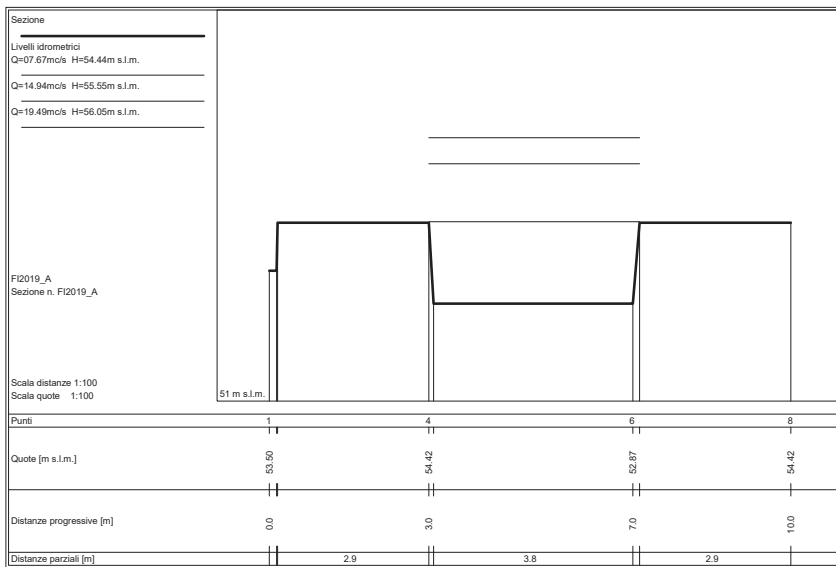
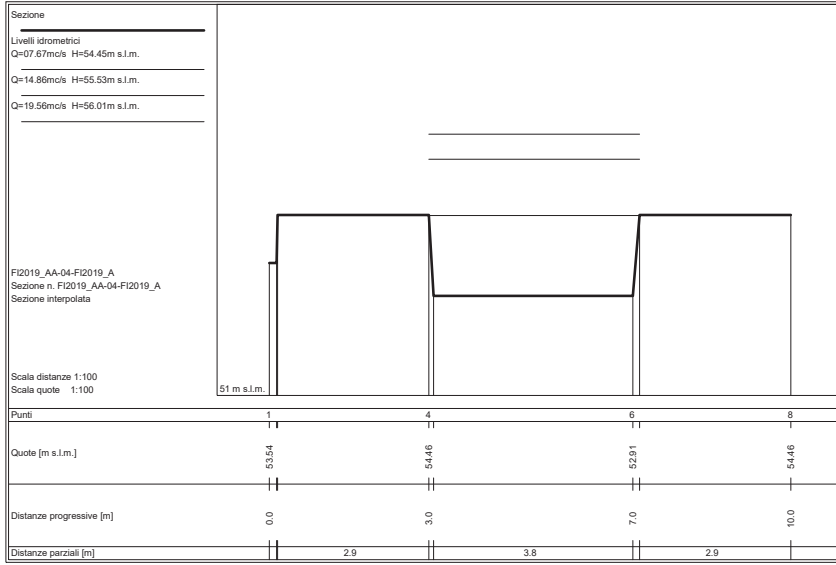

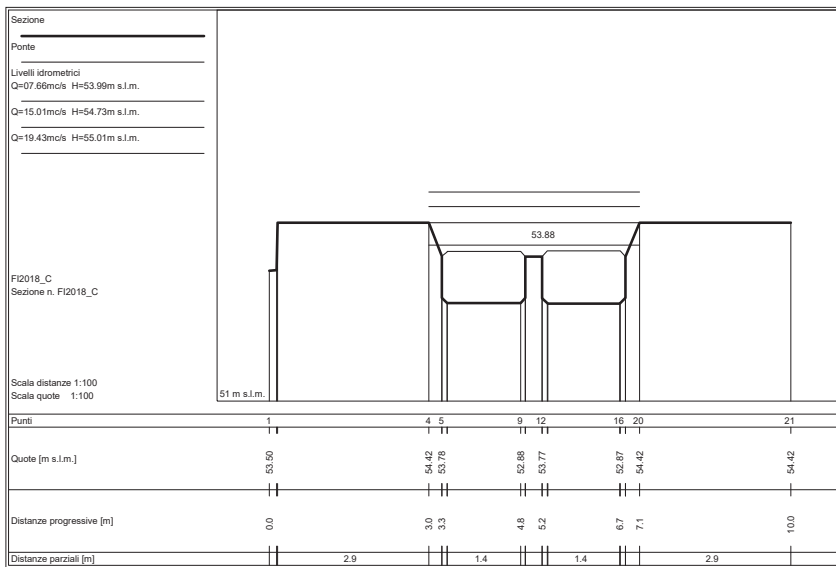
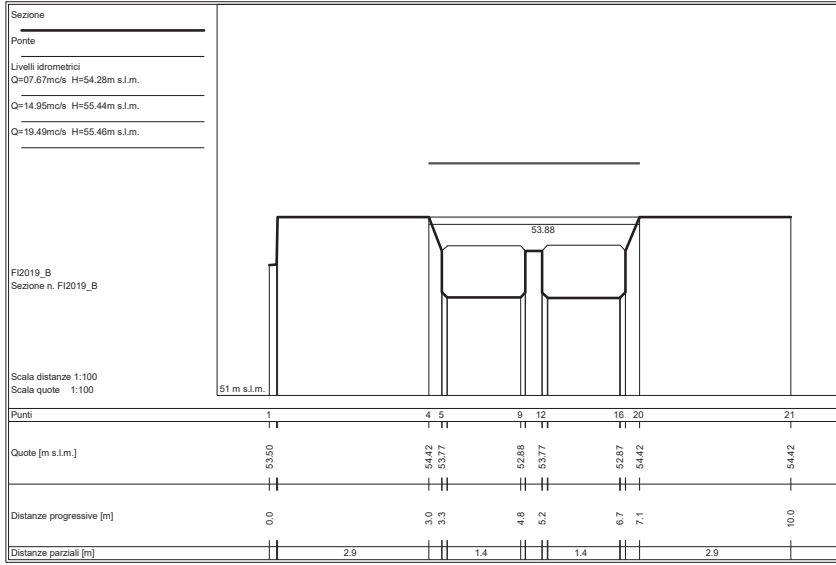

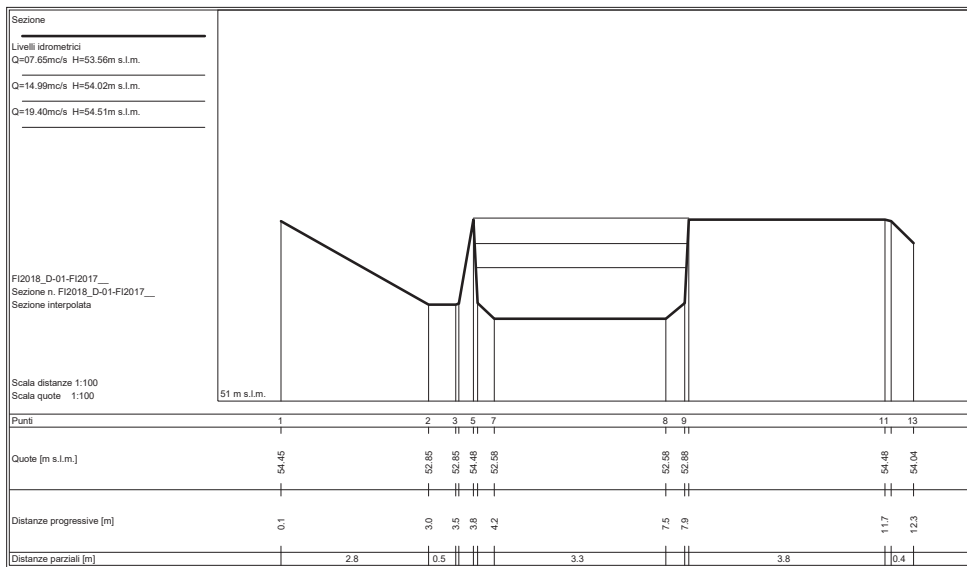
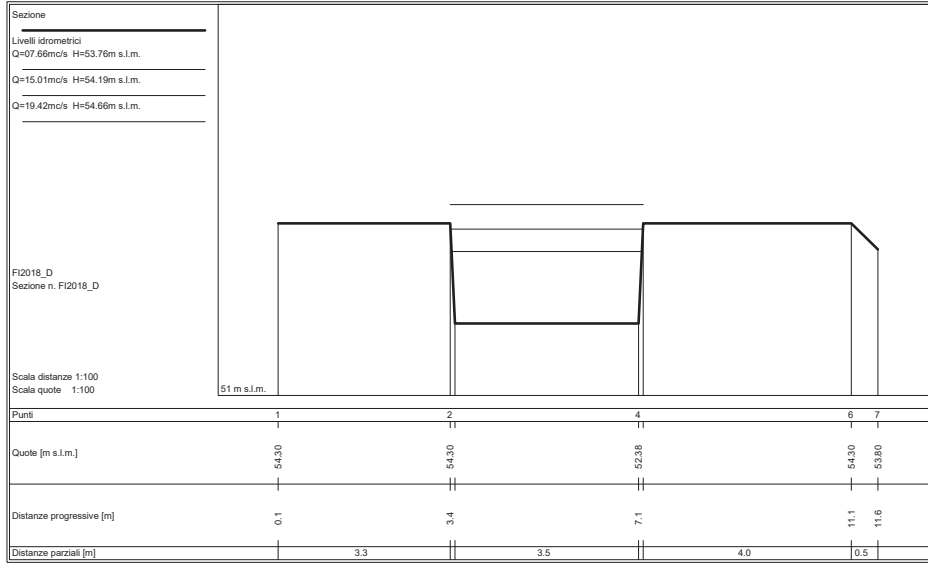



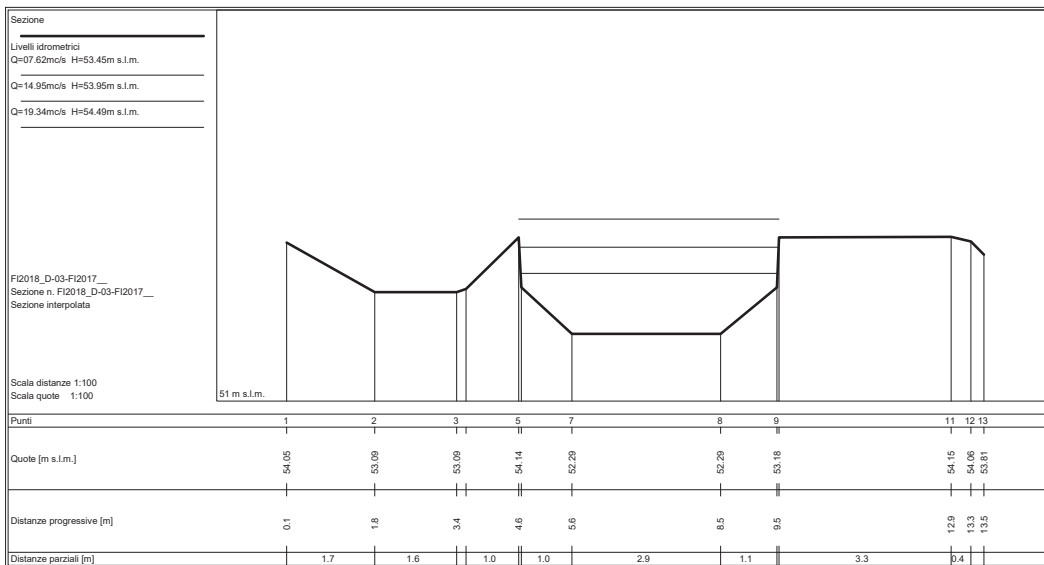
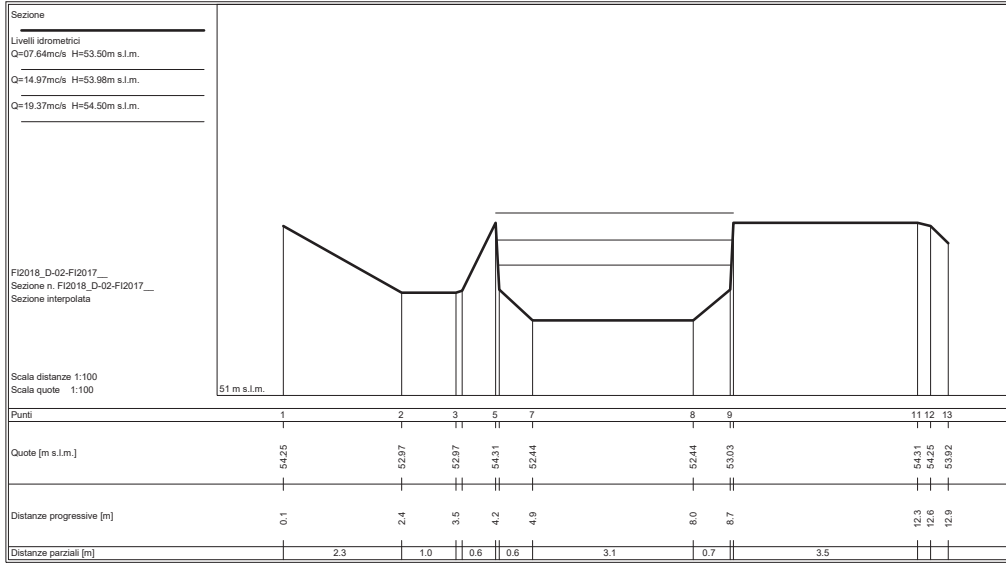

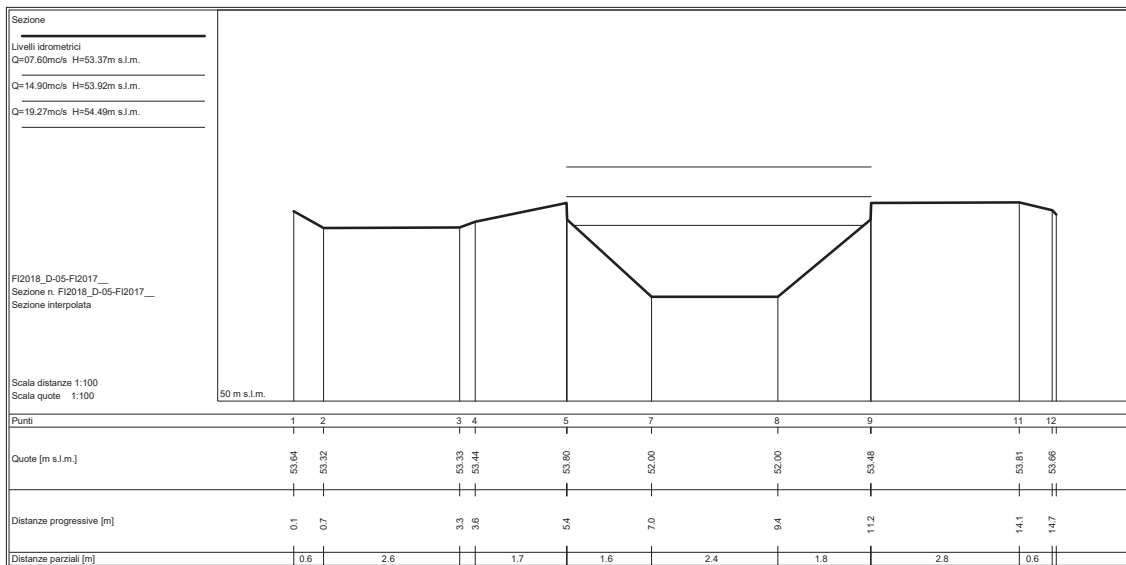
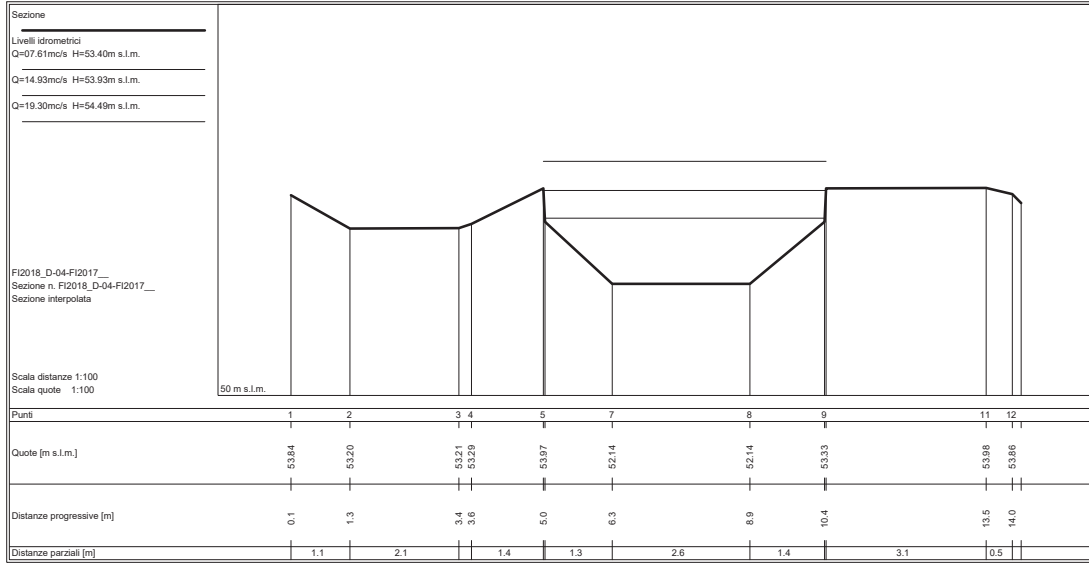

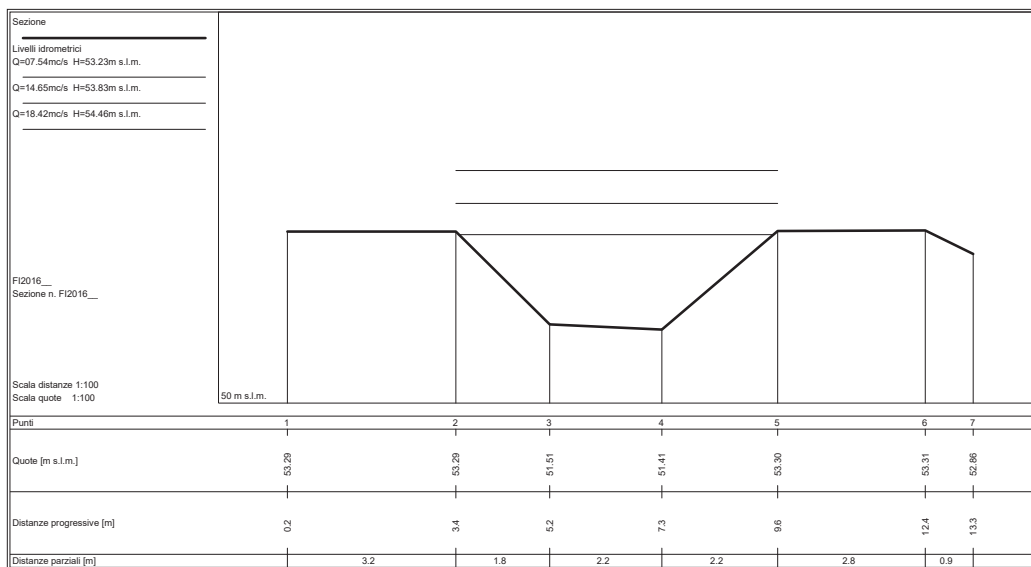
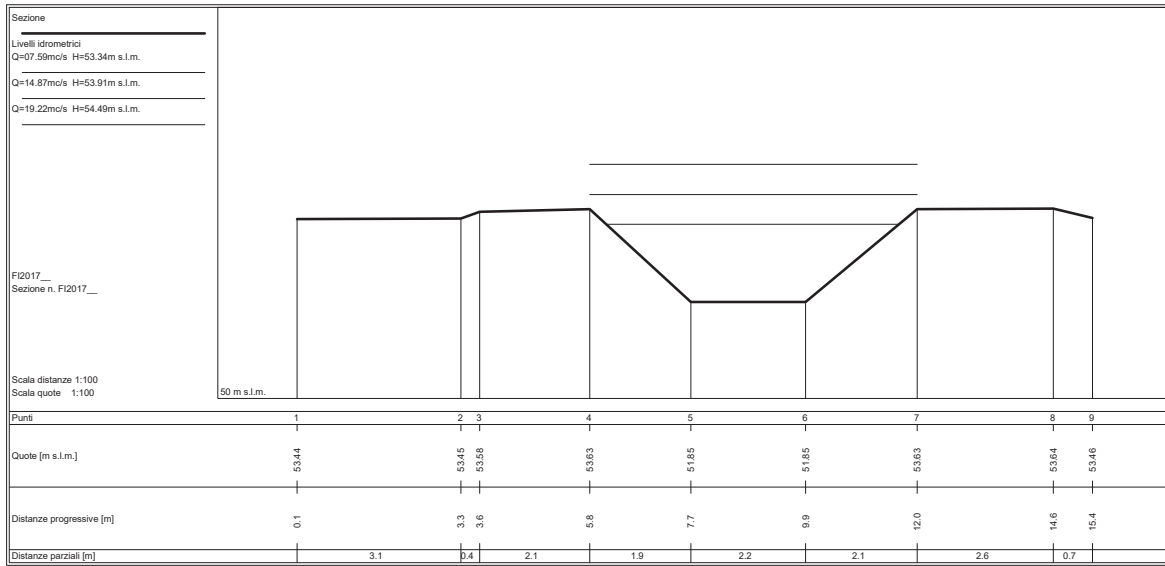

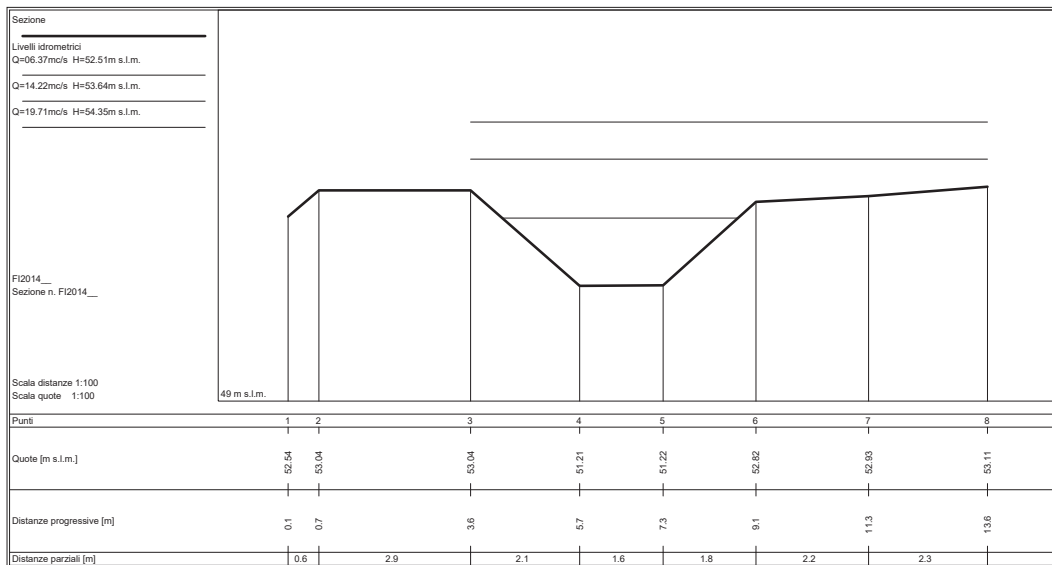
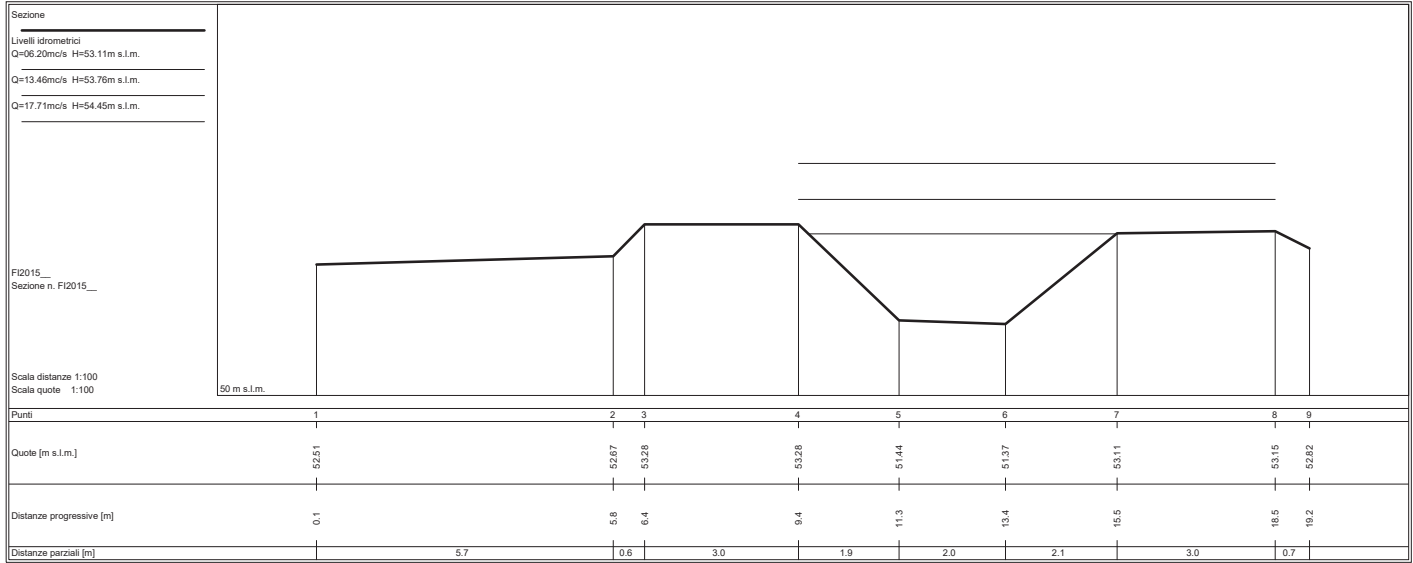

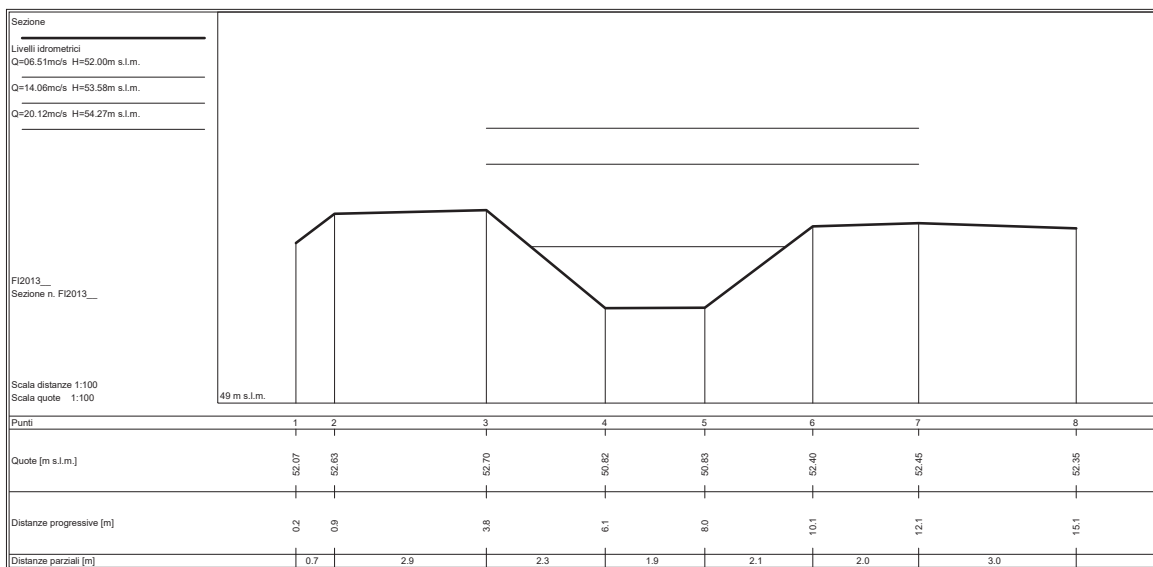
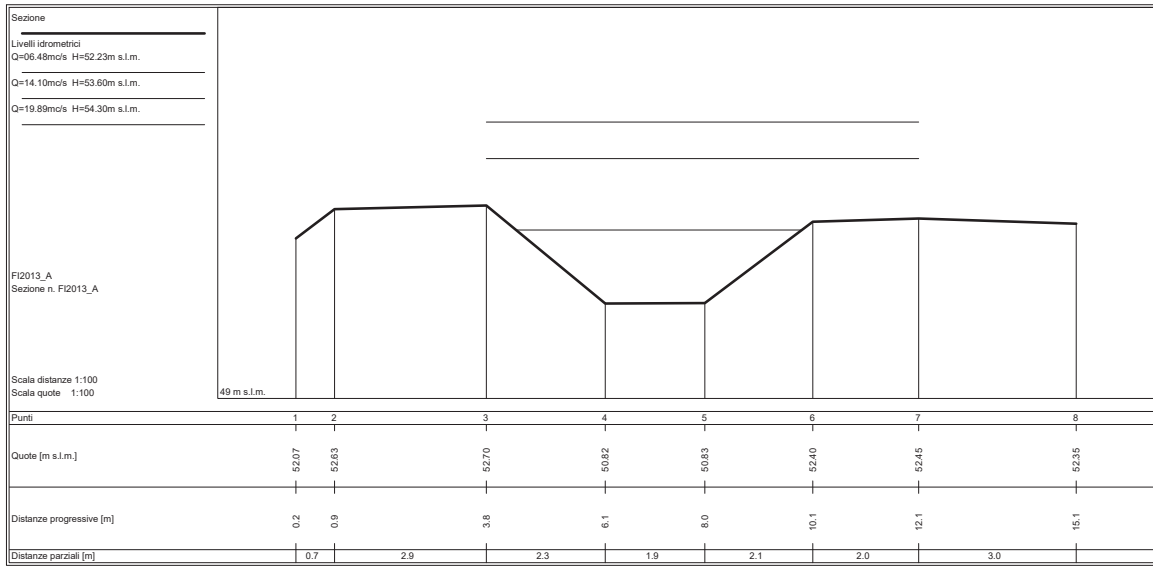

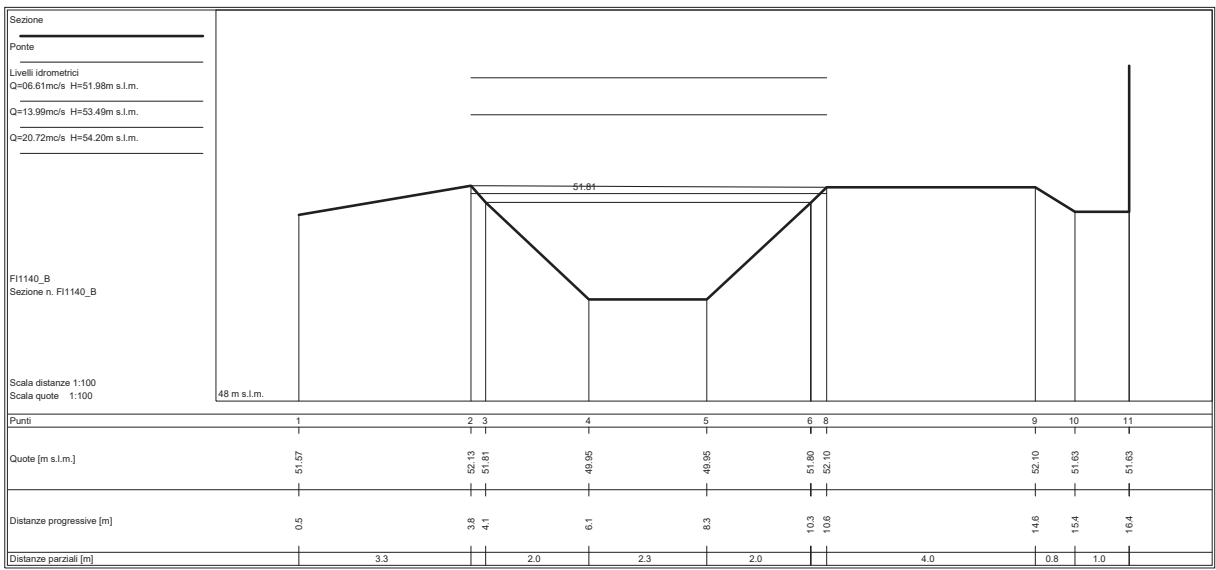
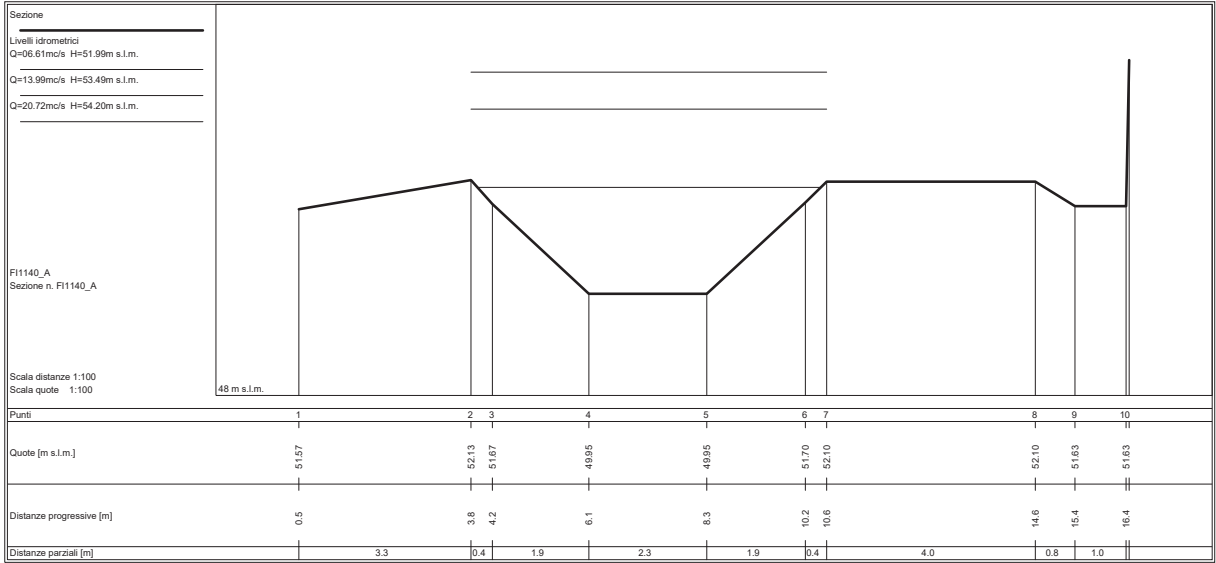

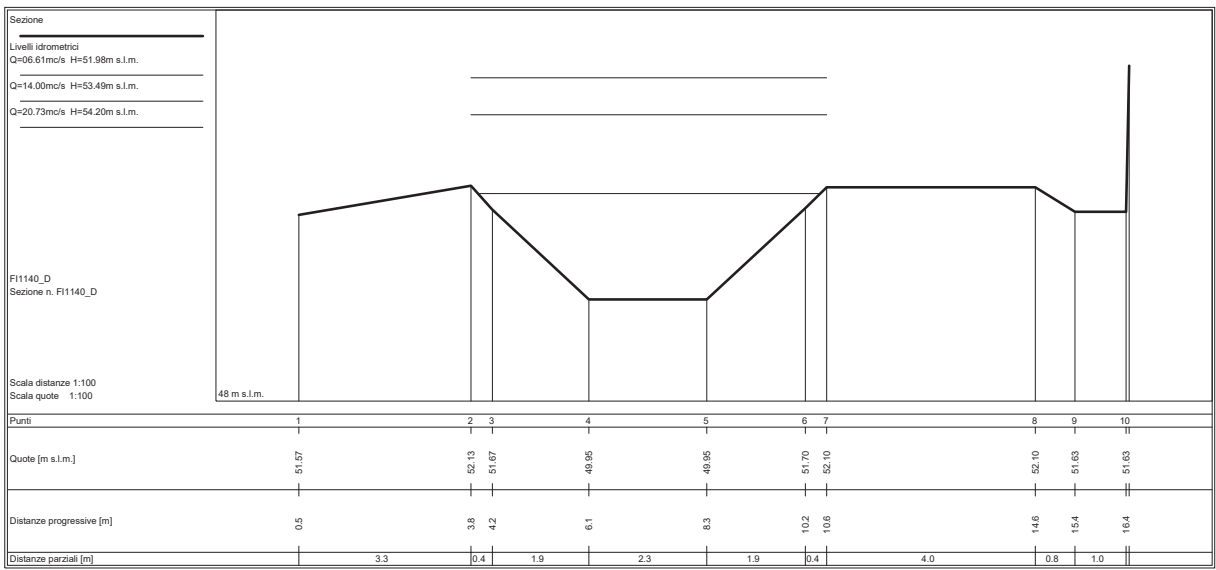
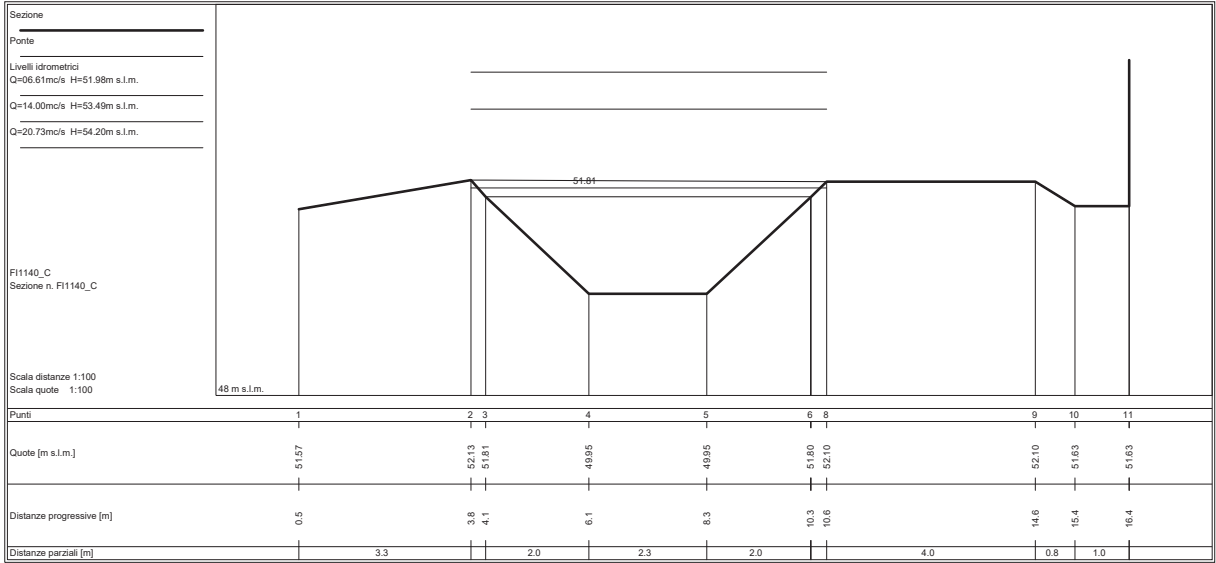

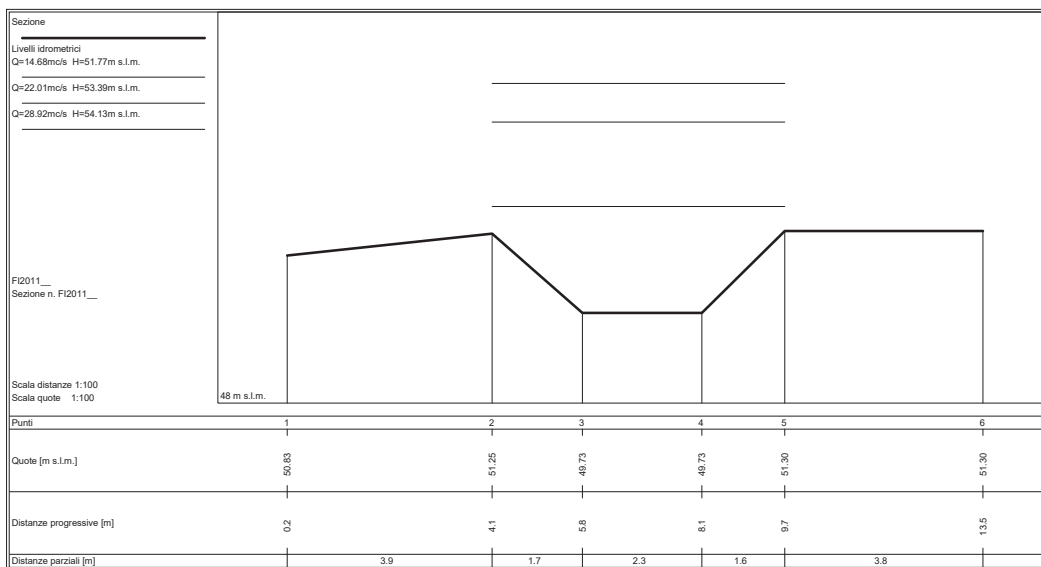
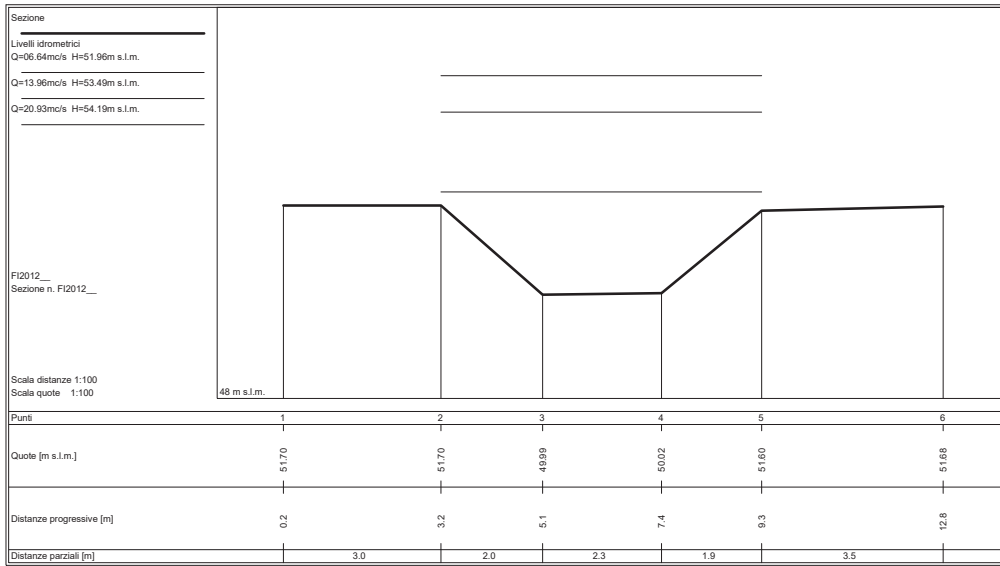



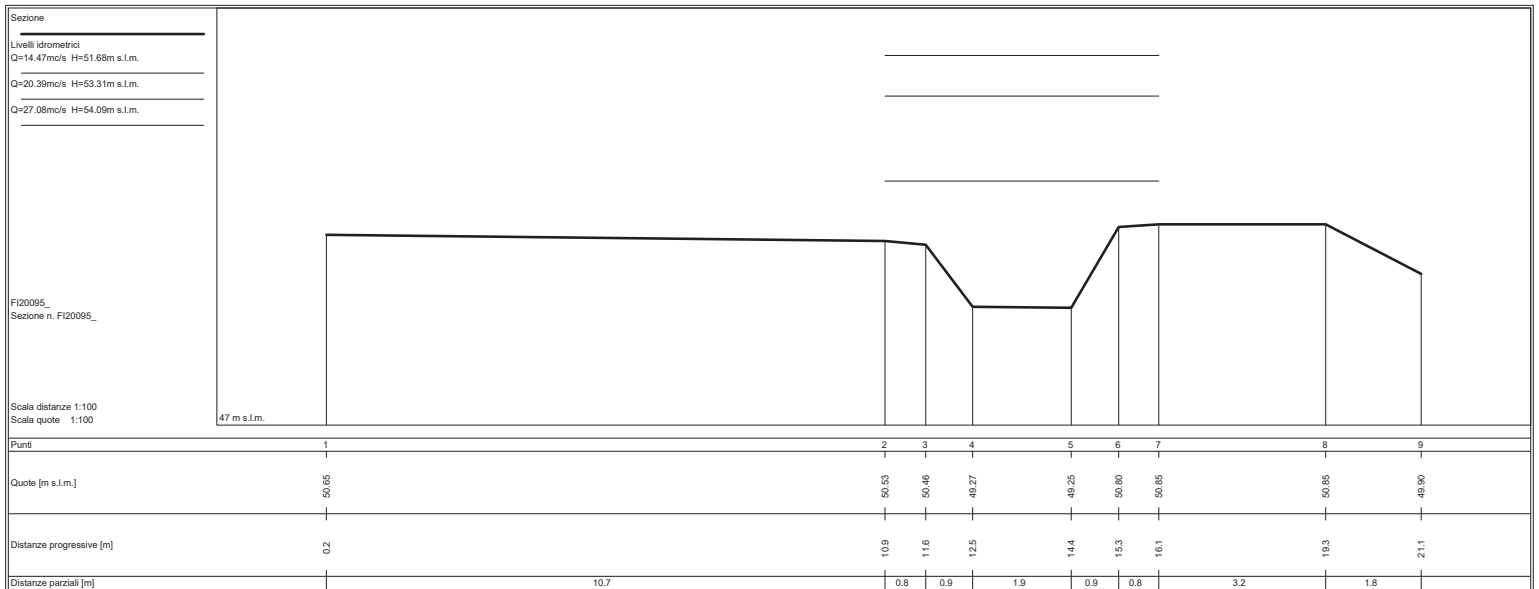
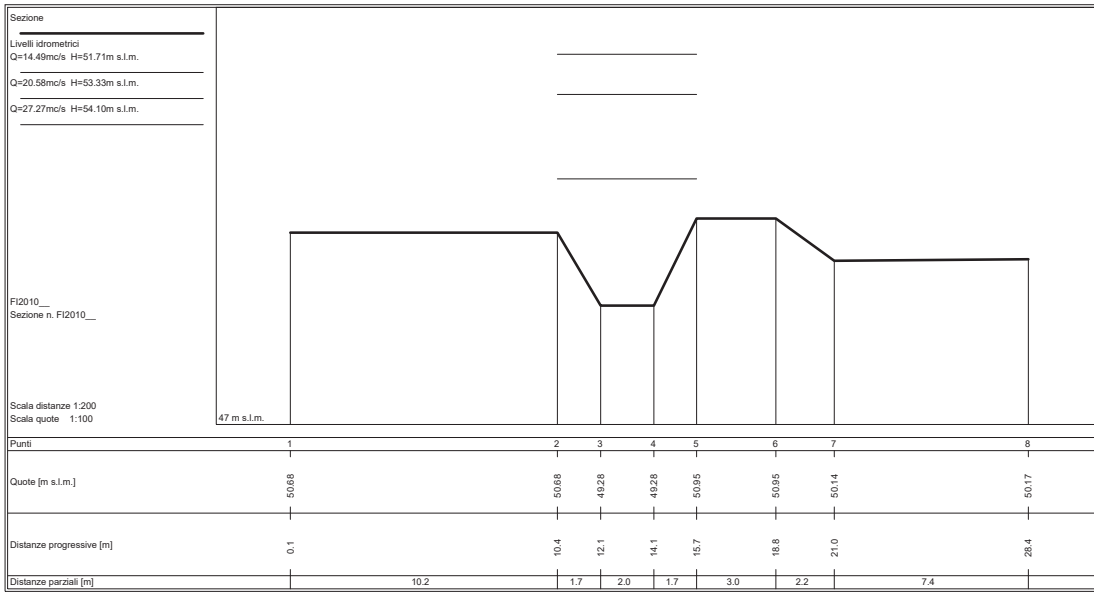

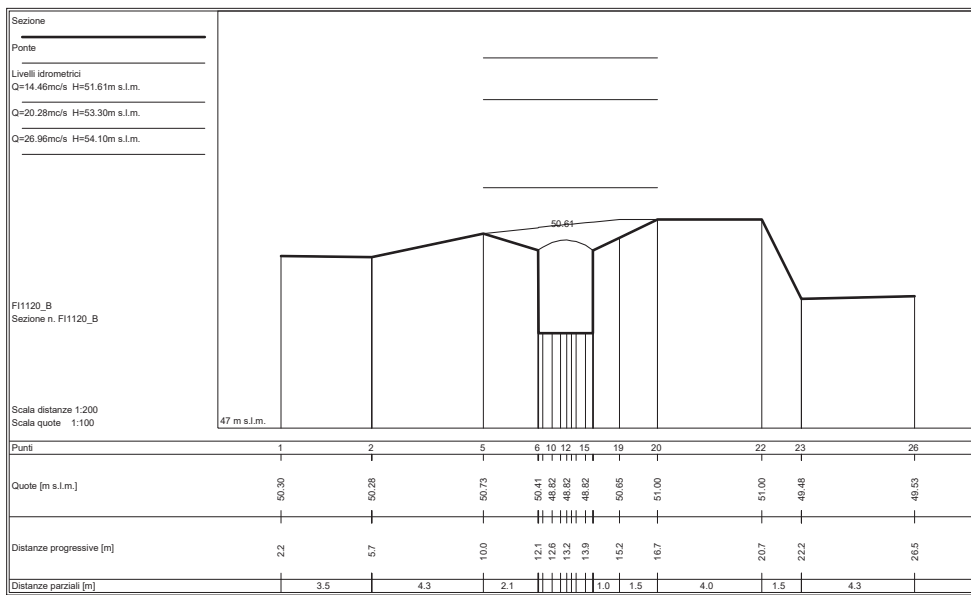
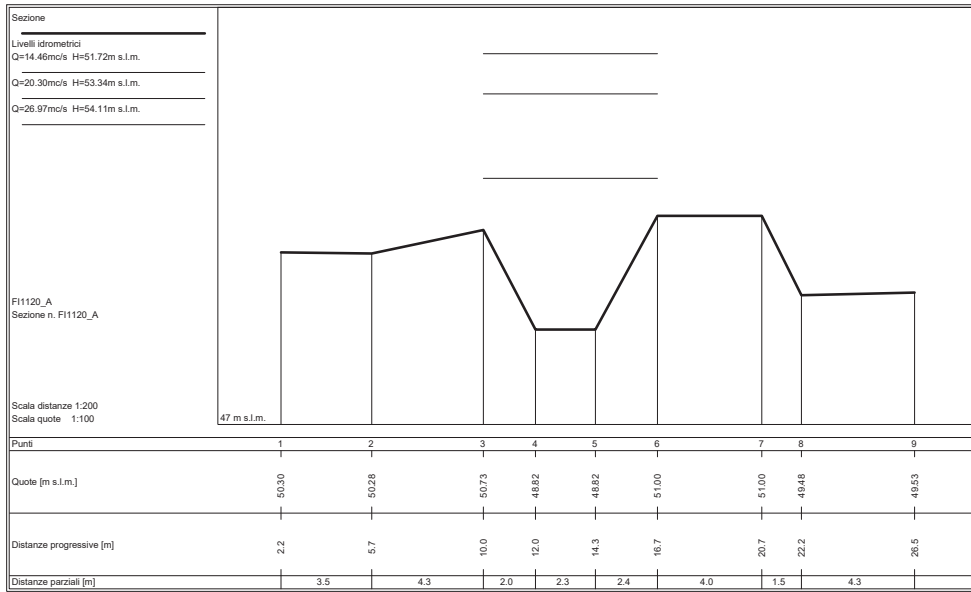

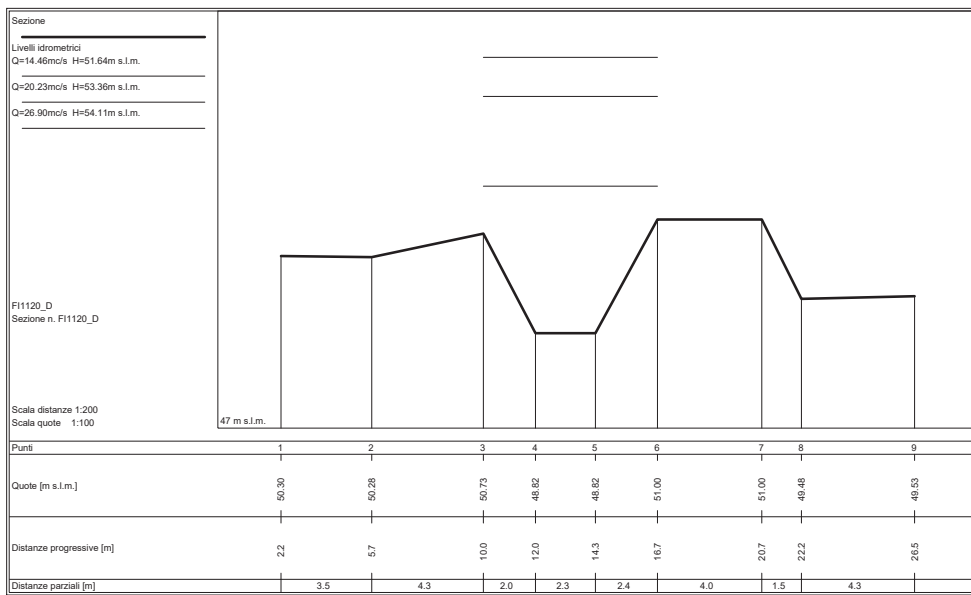
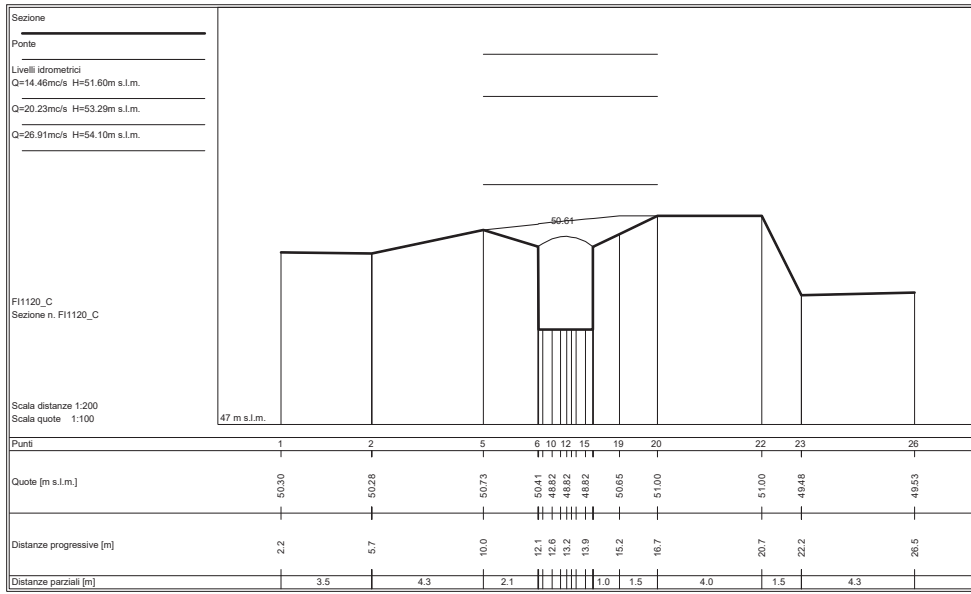

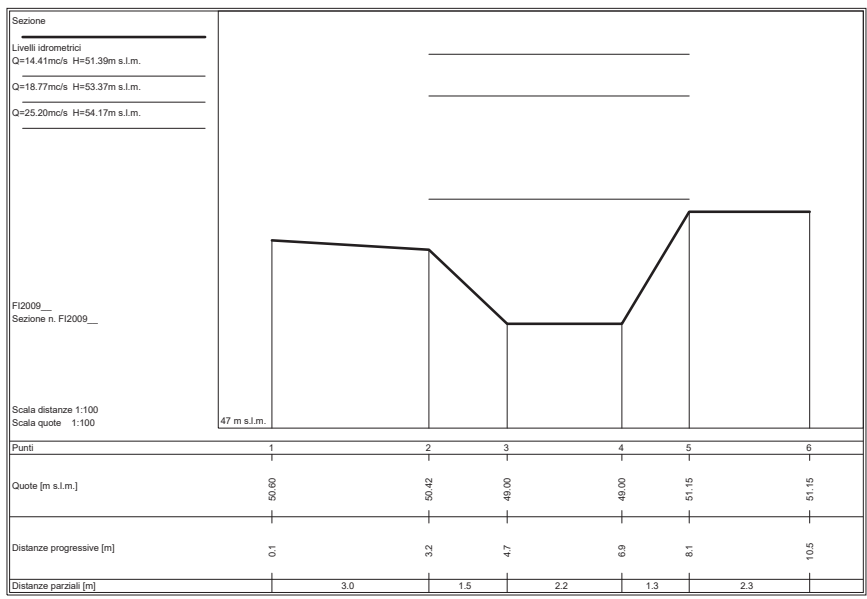
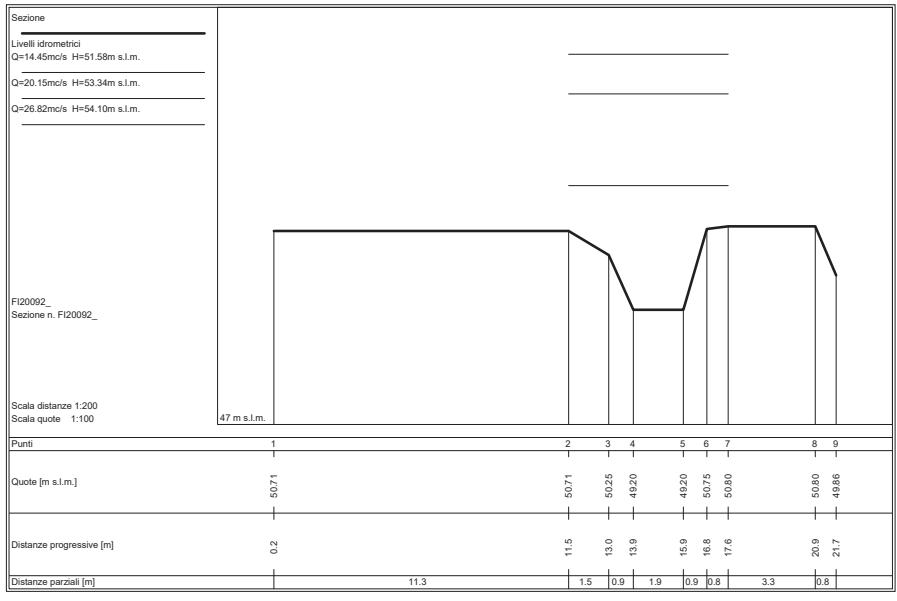

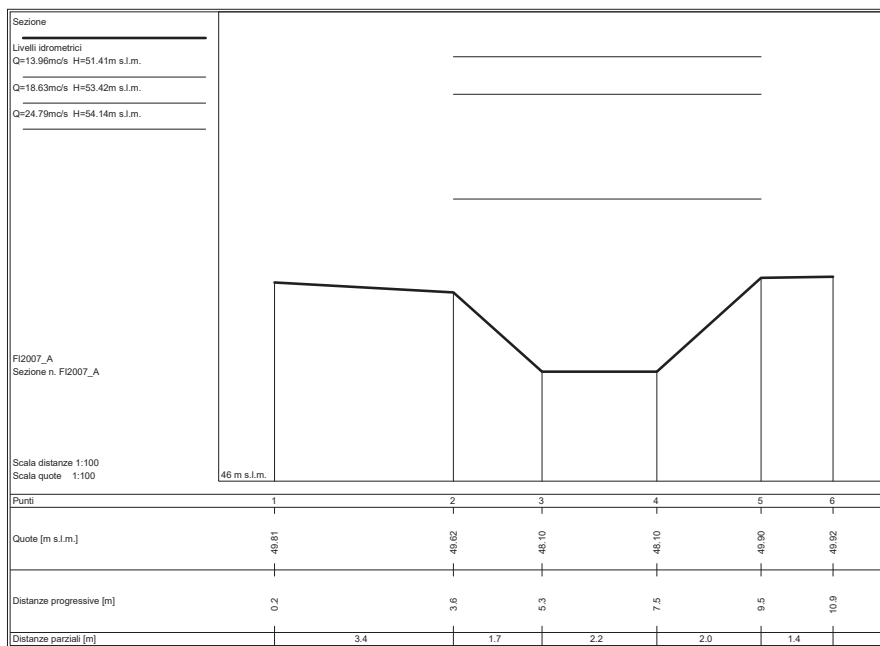
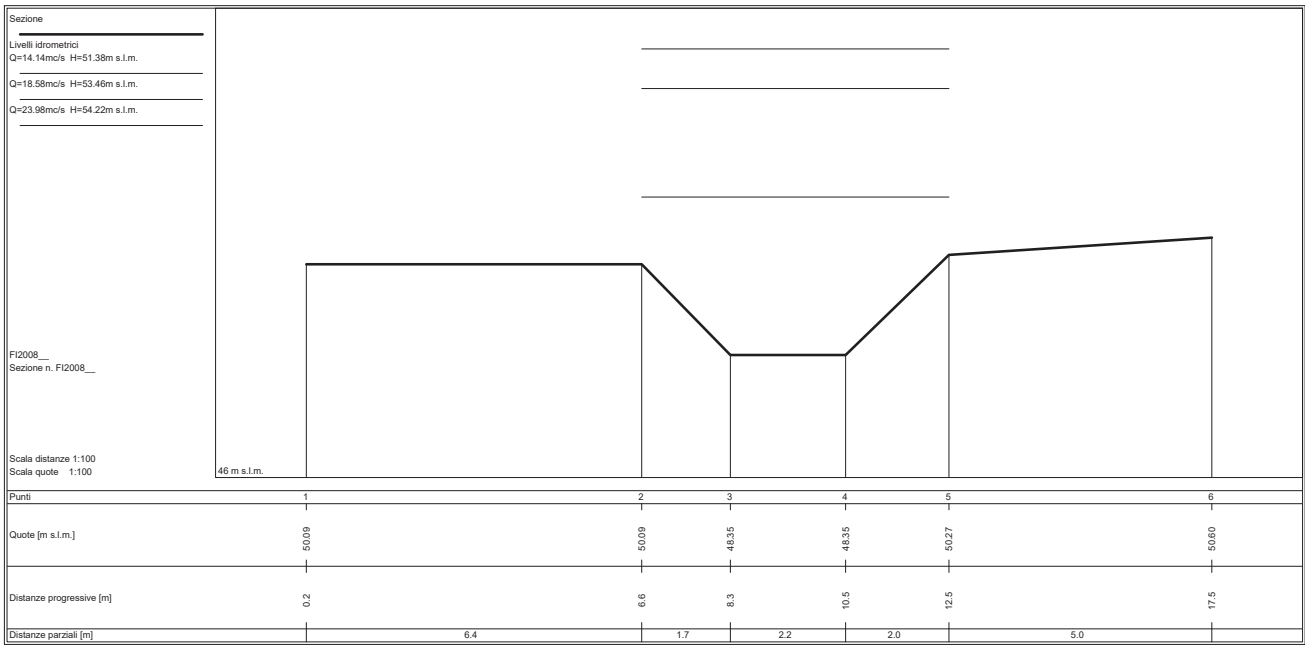

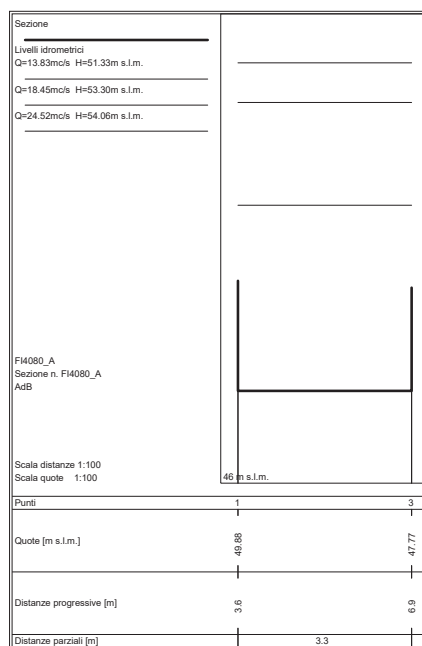
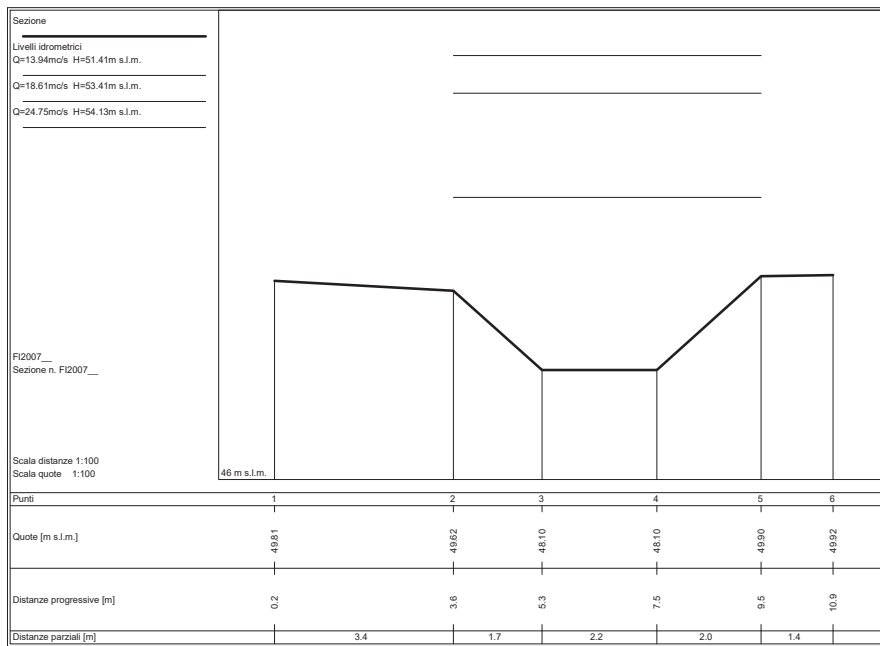

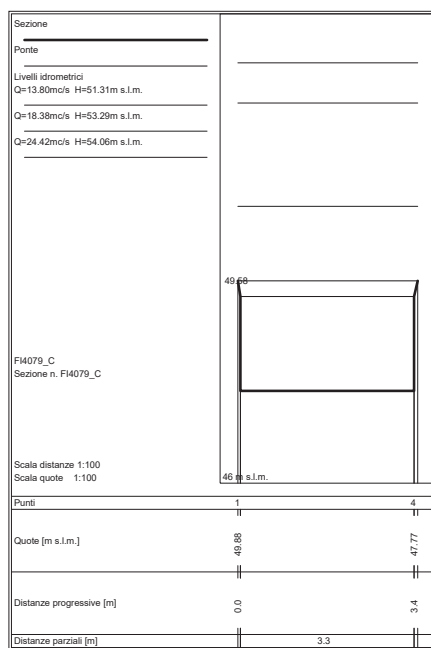
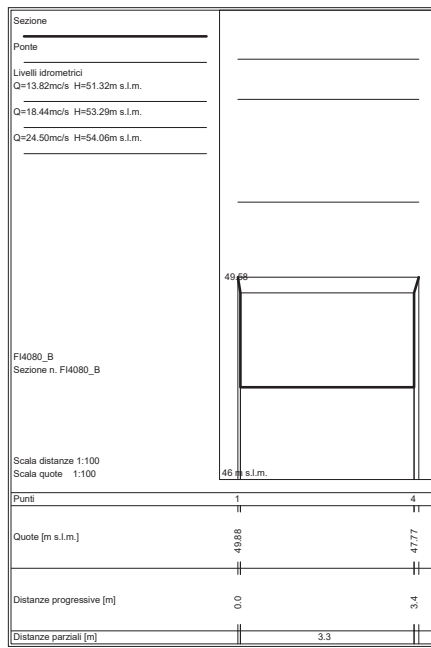

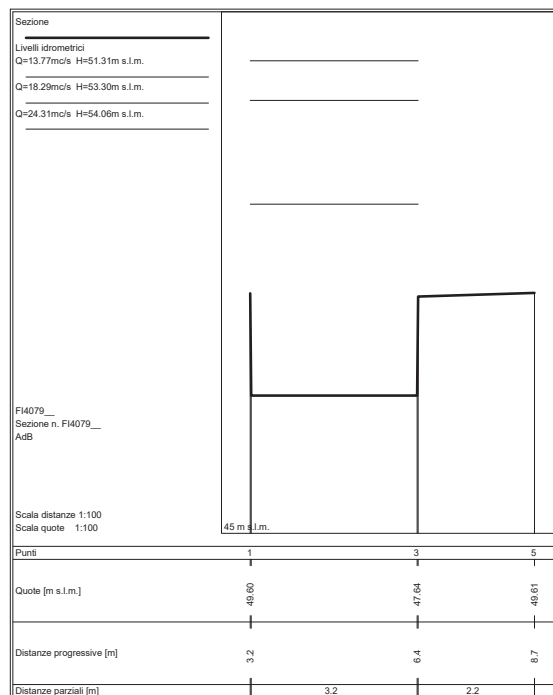
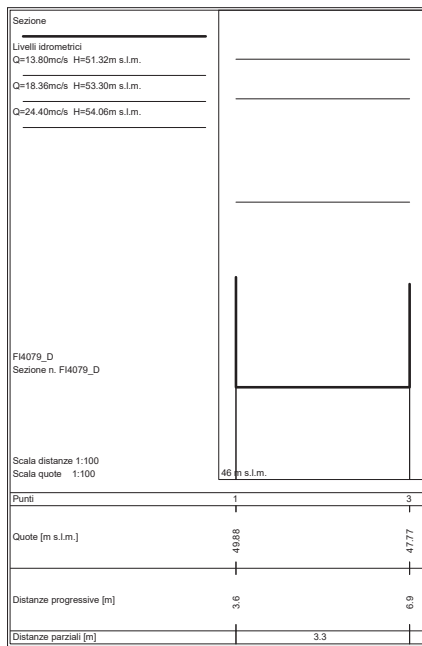



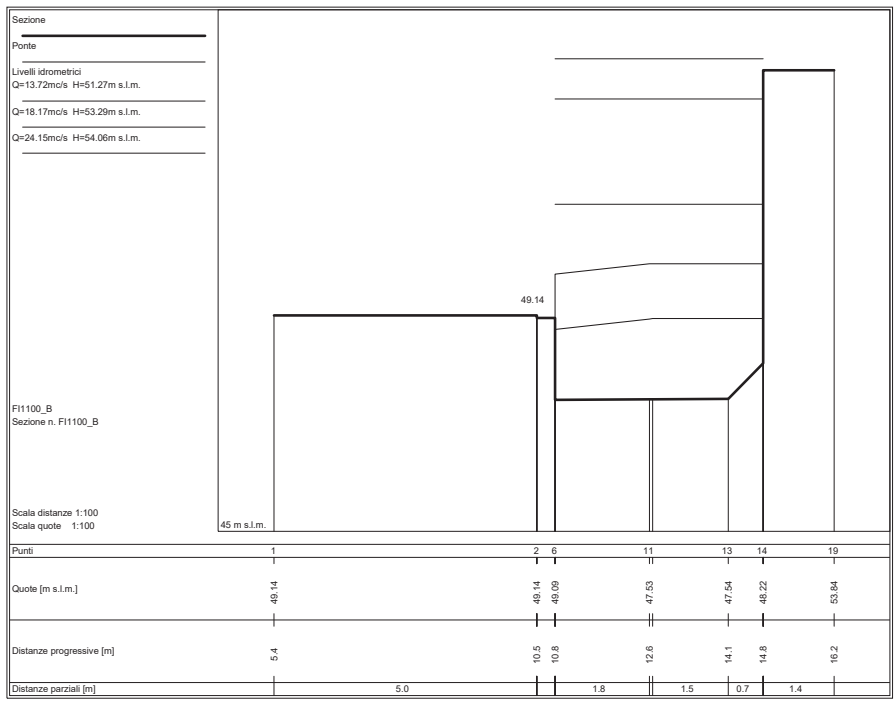
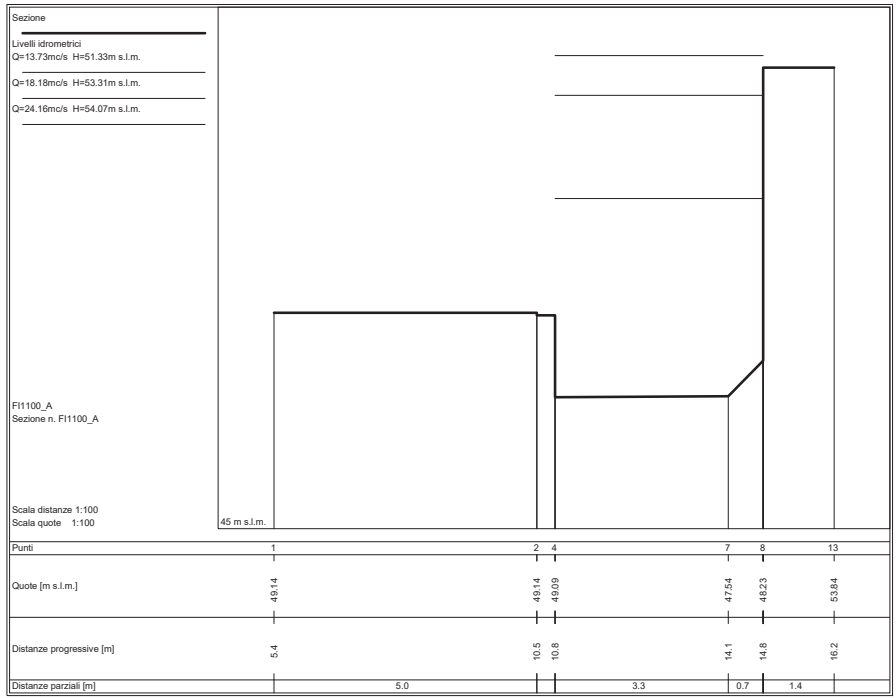

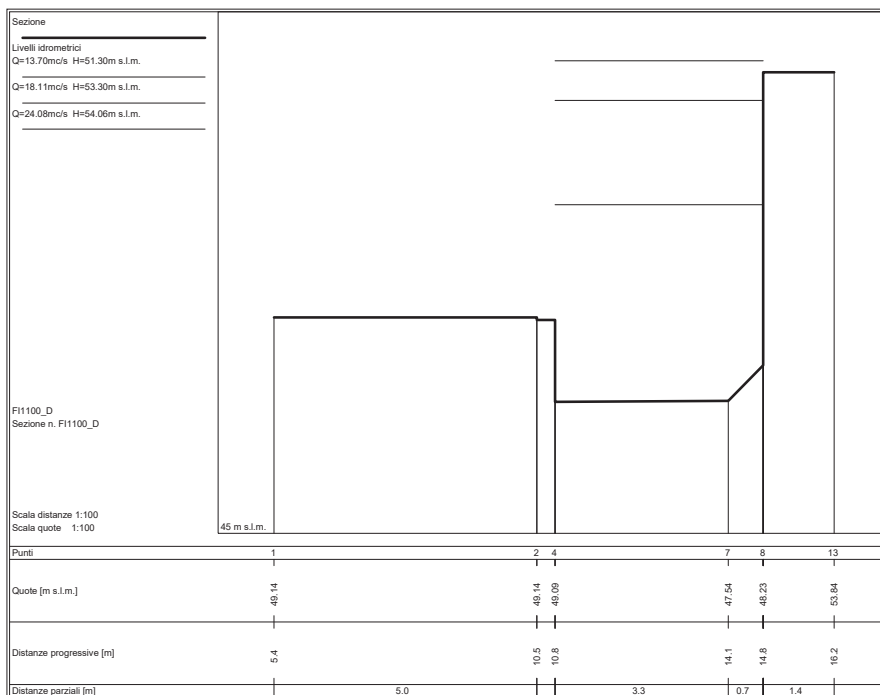
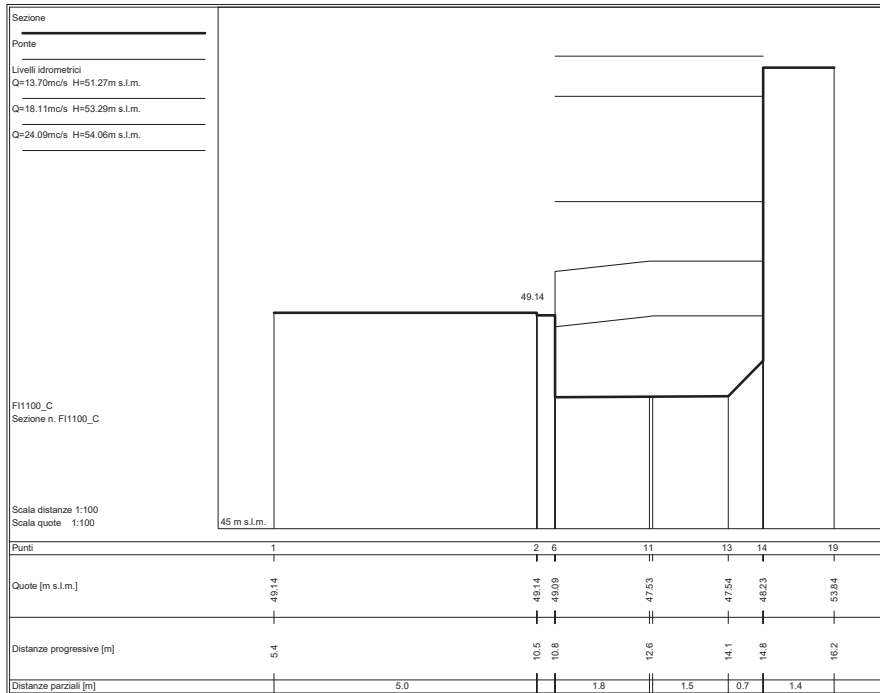

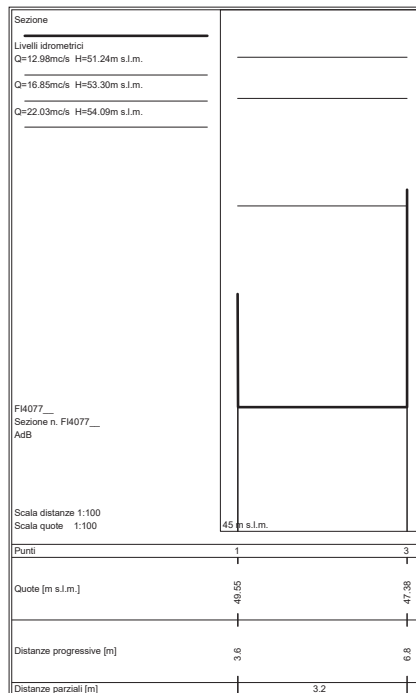
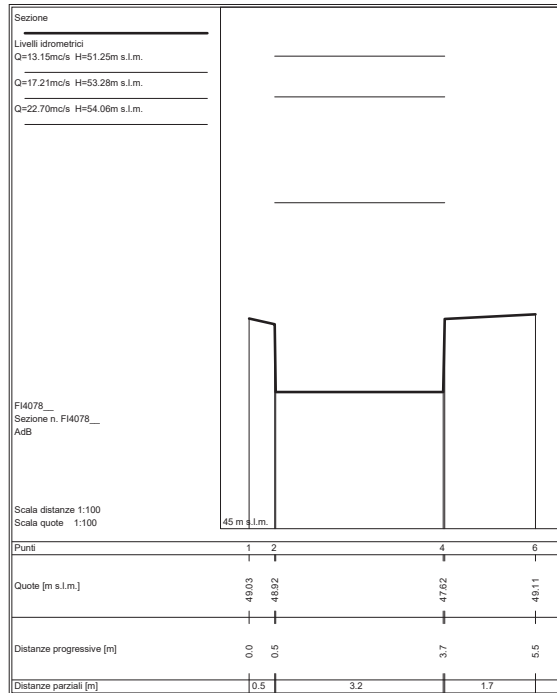

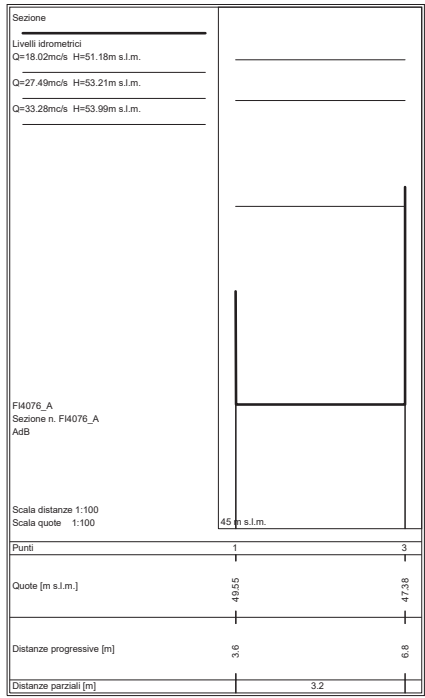

SEZIONI FLUVIALI  
FOSSO DI GUARDIA

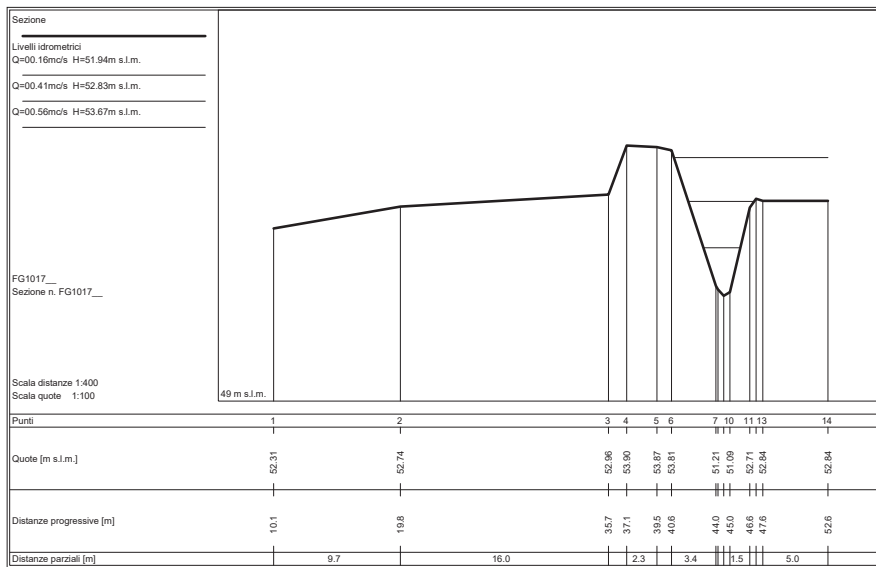
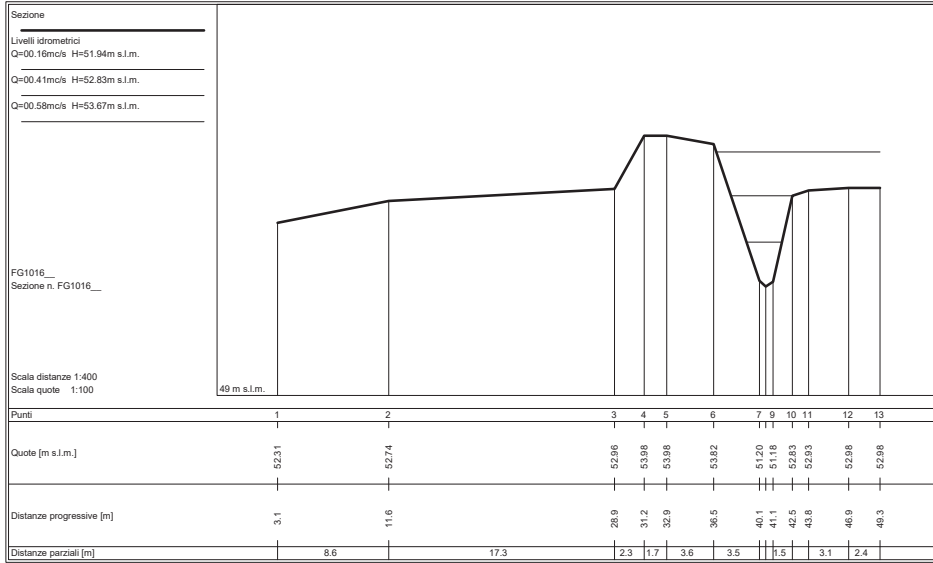

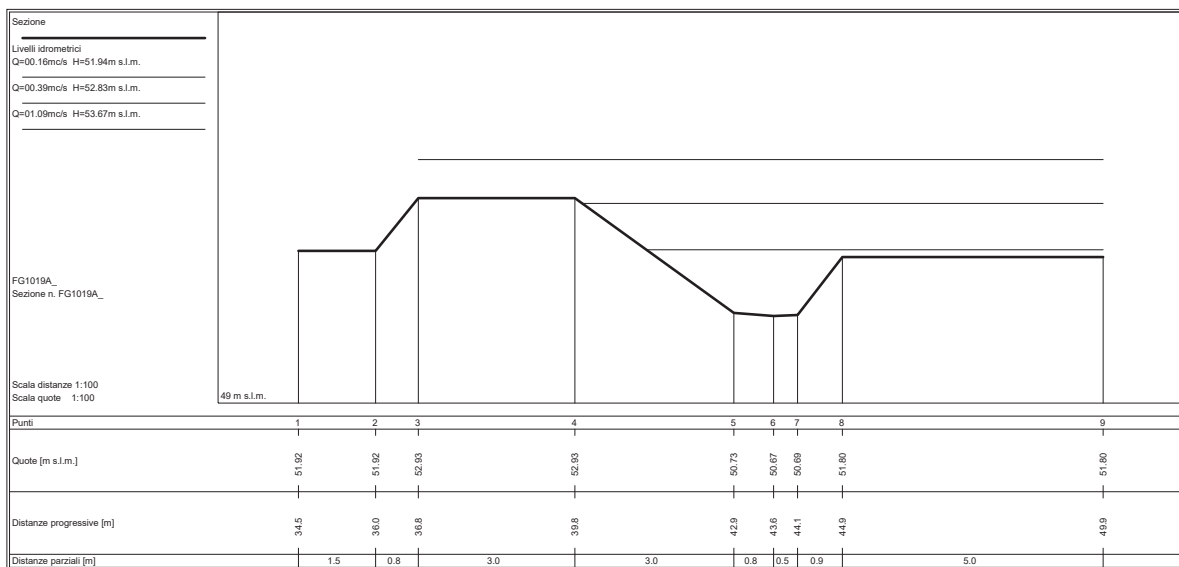
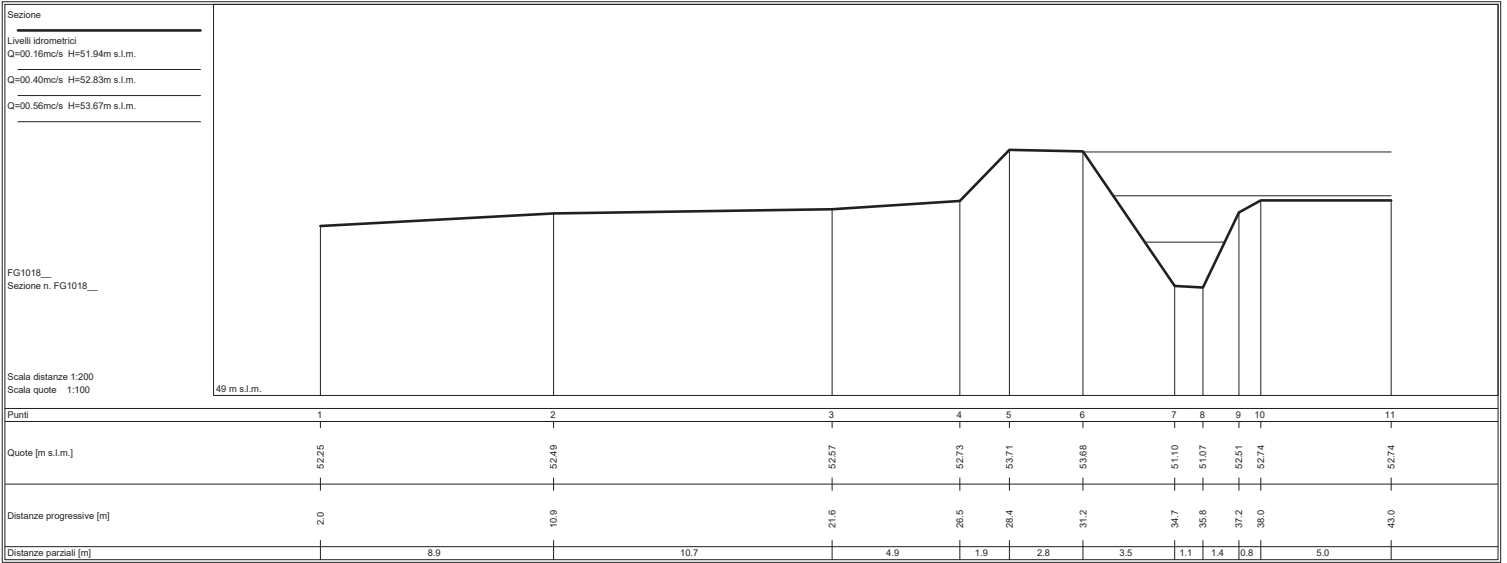

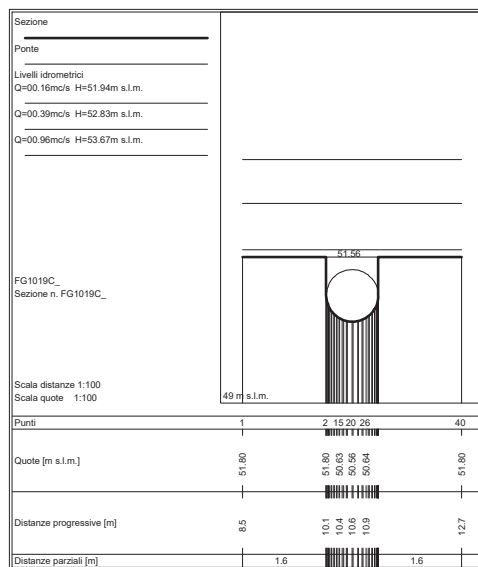
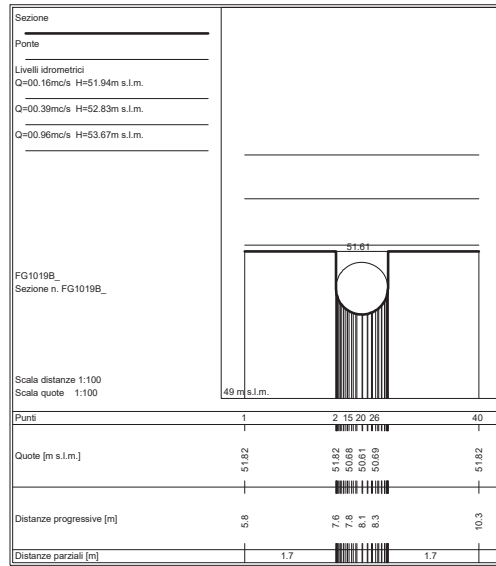



SEZIONI FLUVIALI  
FOSSO FUNANDOLA - TRATTO 1

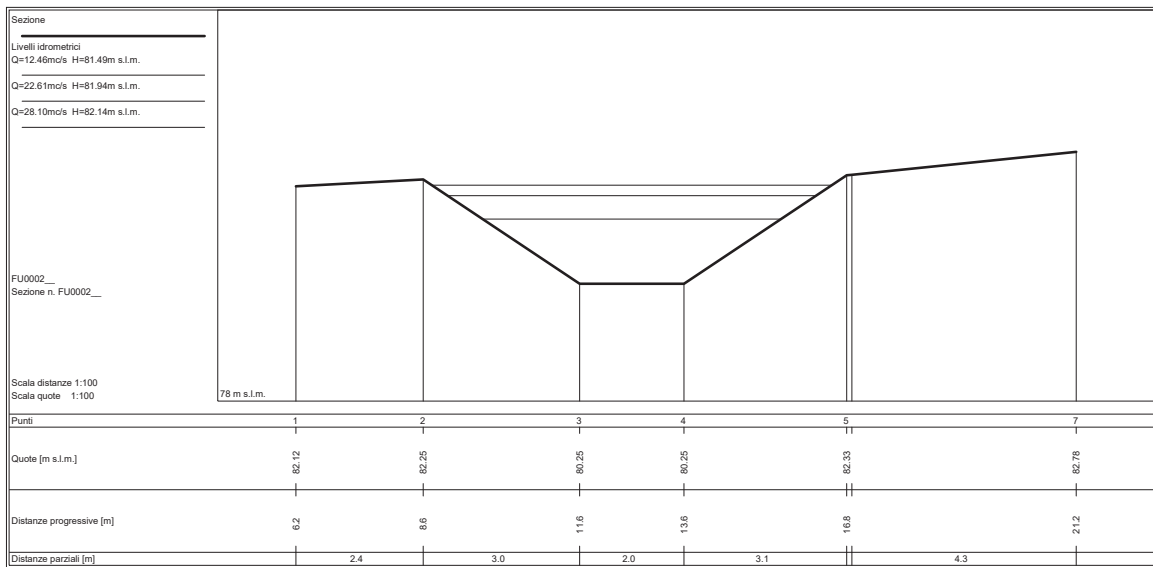
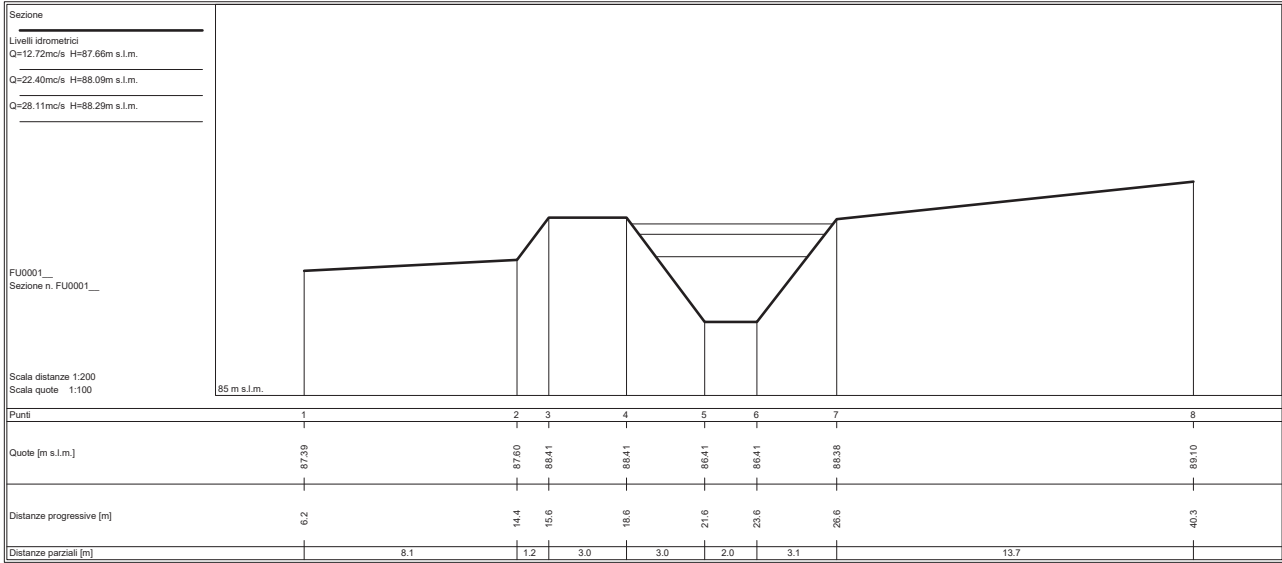

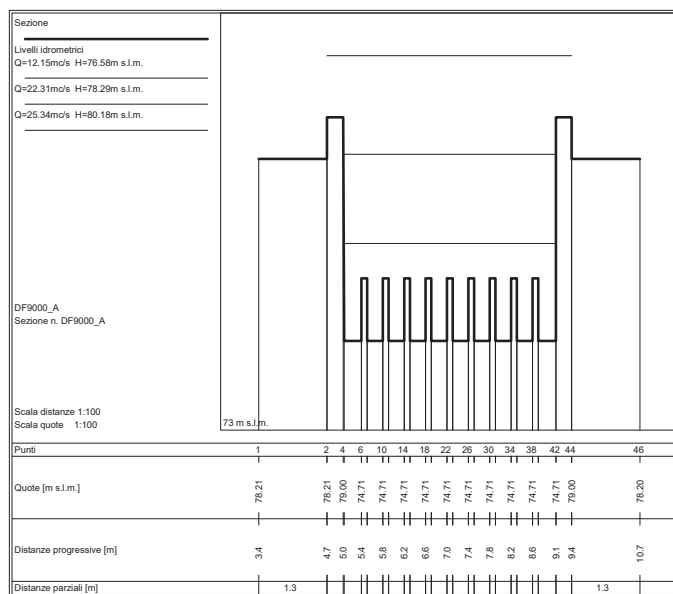
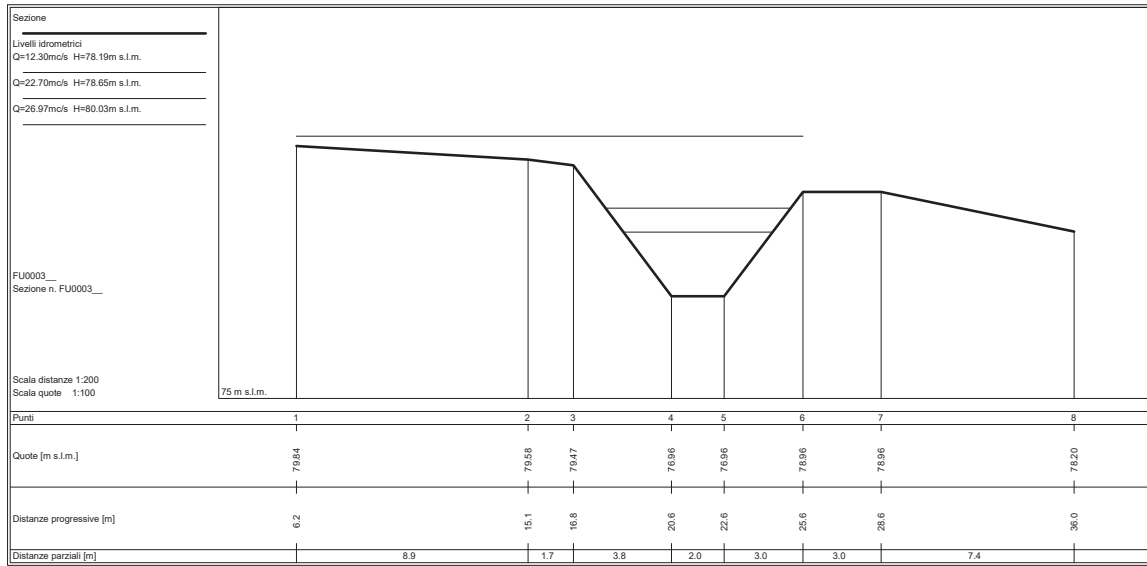

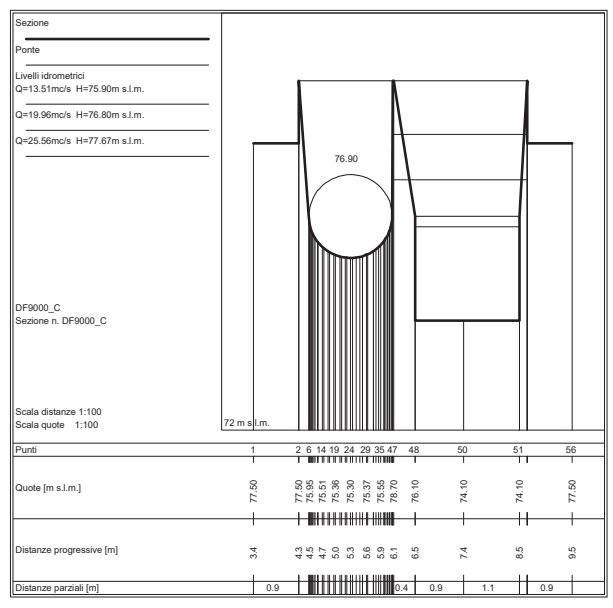
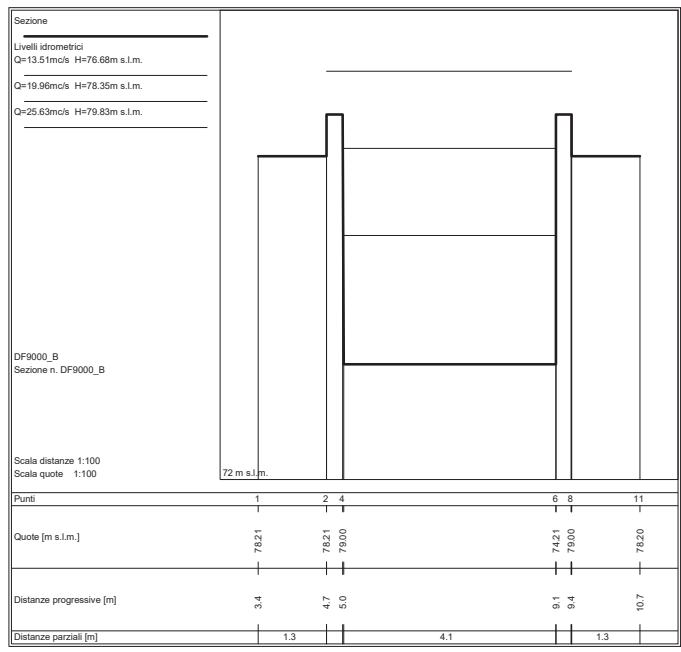

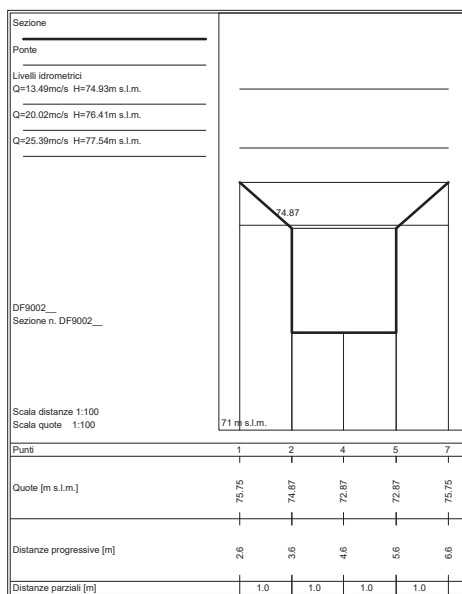
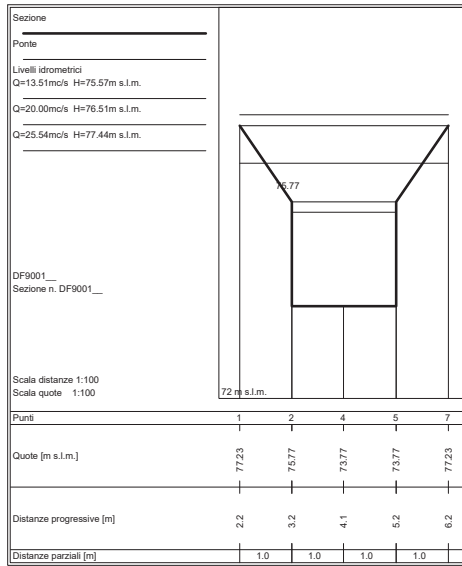

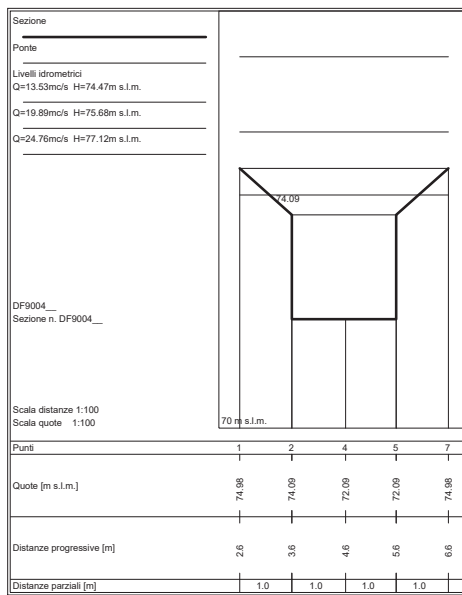
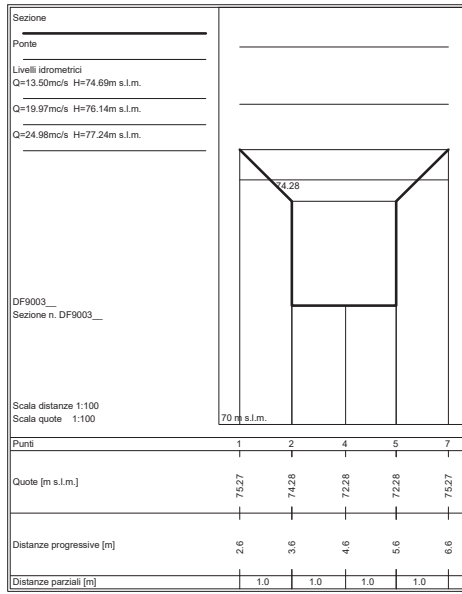

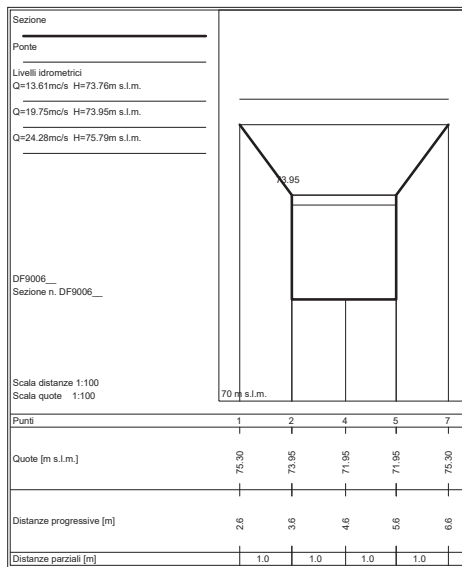
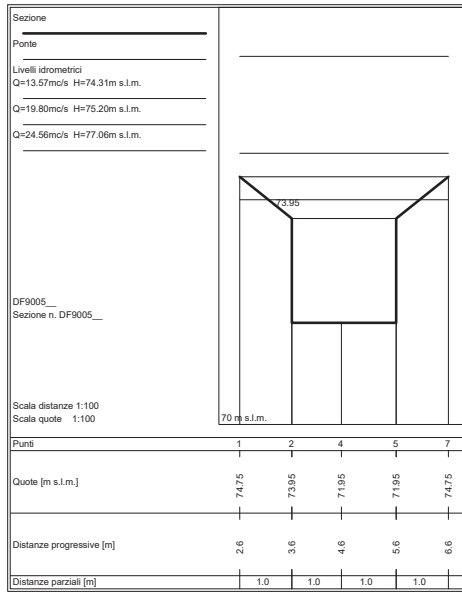

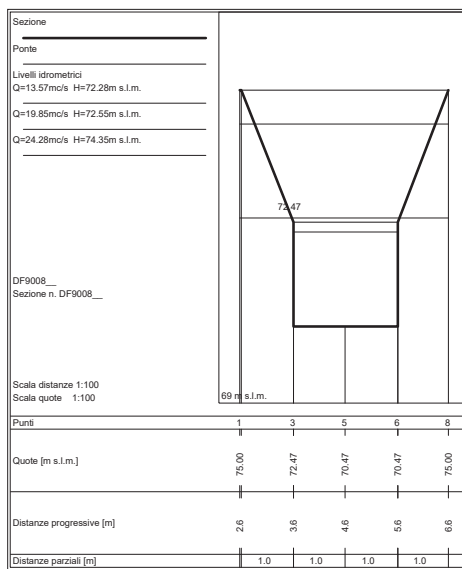
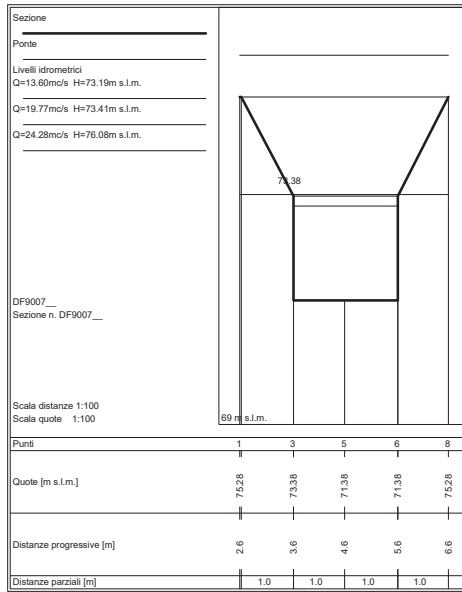



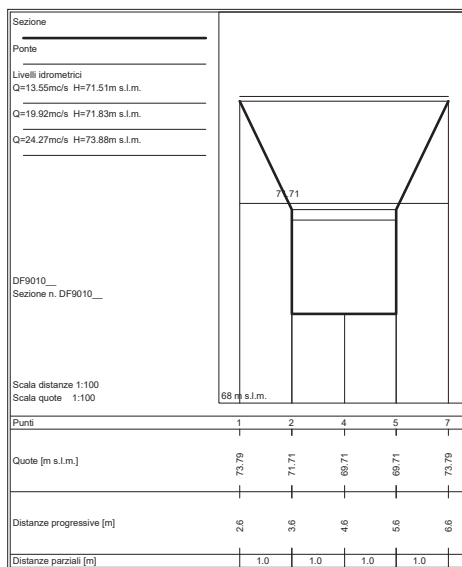
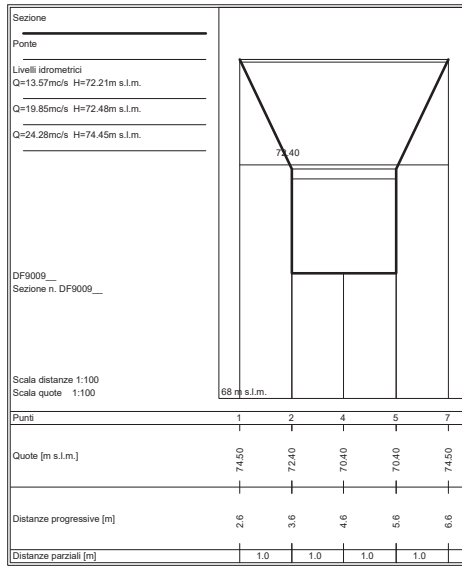

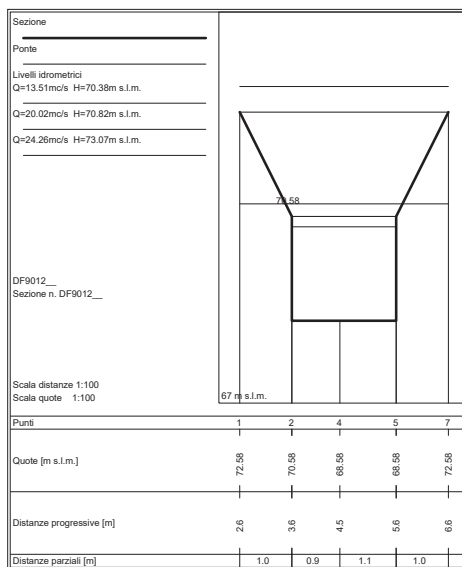
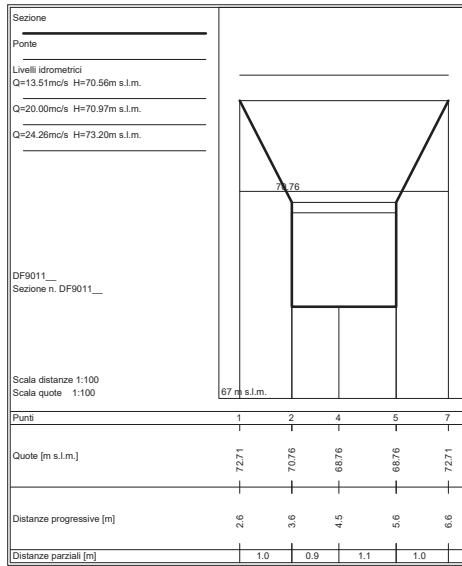

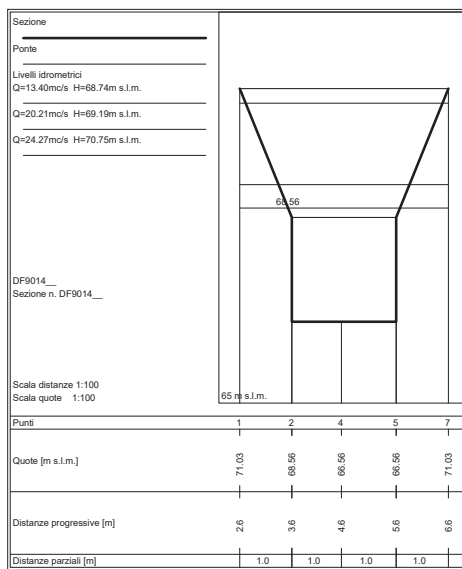
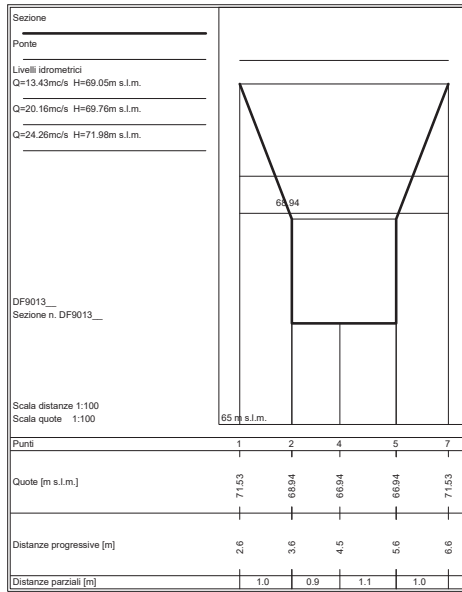

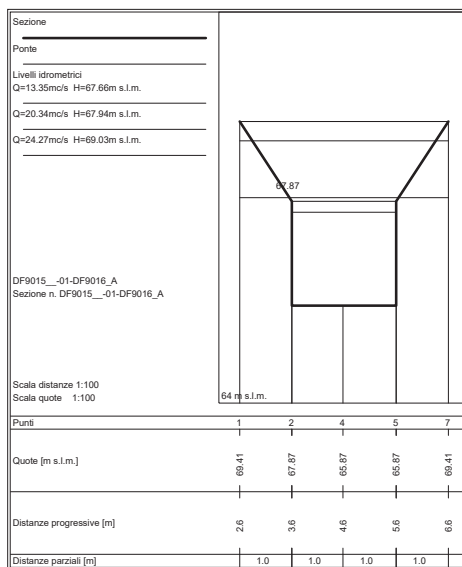
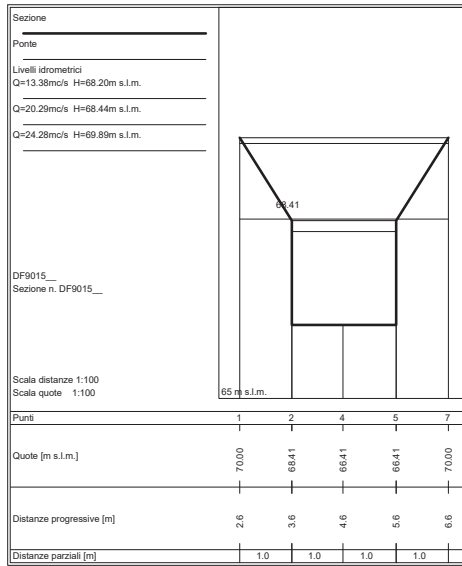

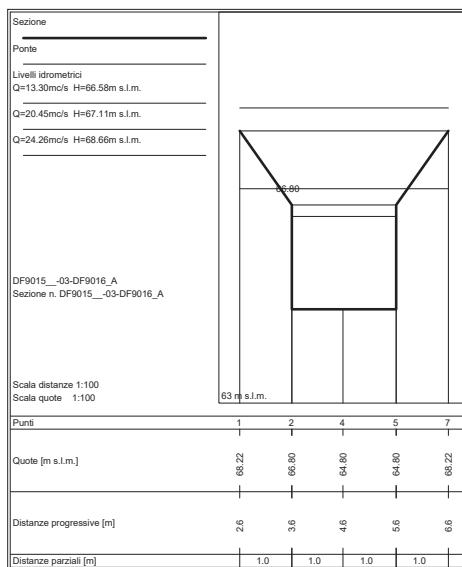
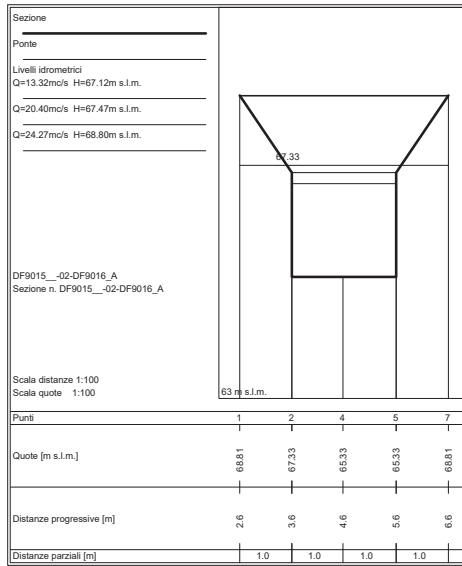

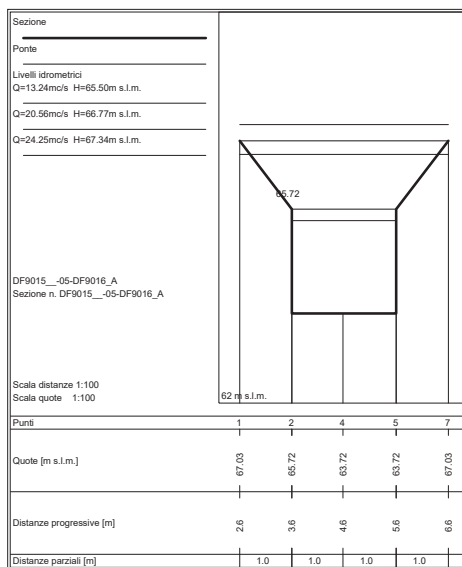
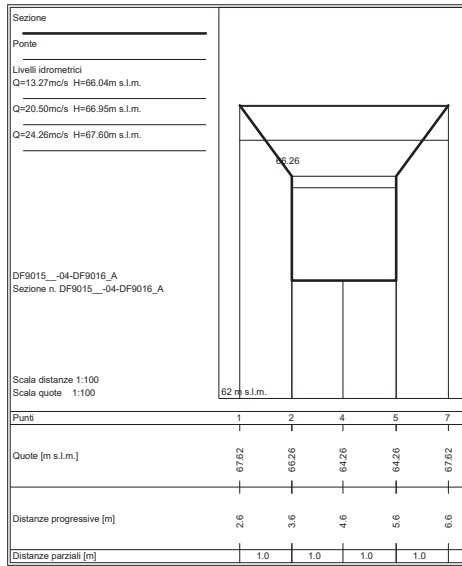

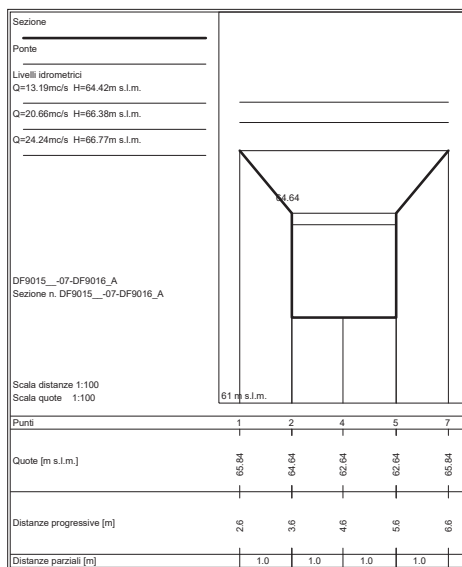
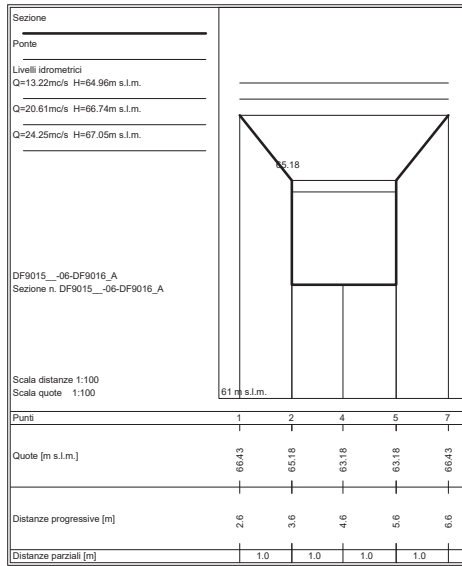

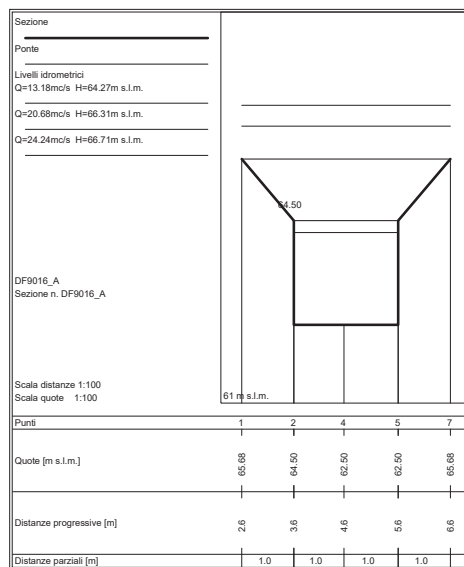
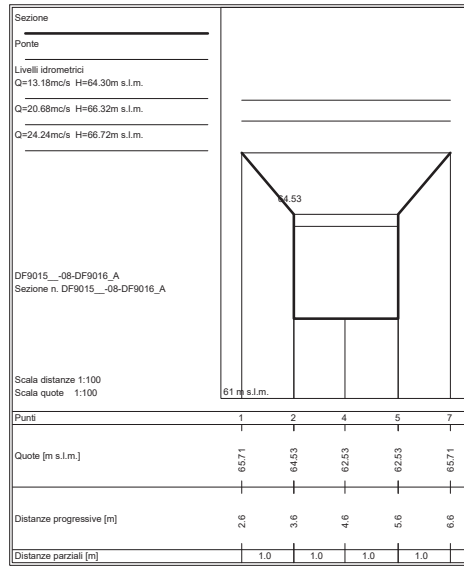



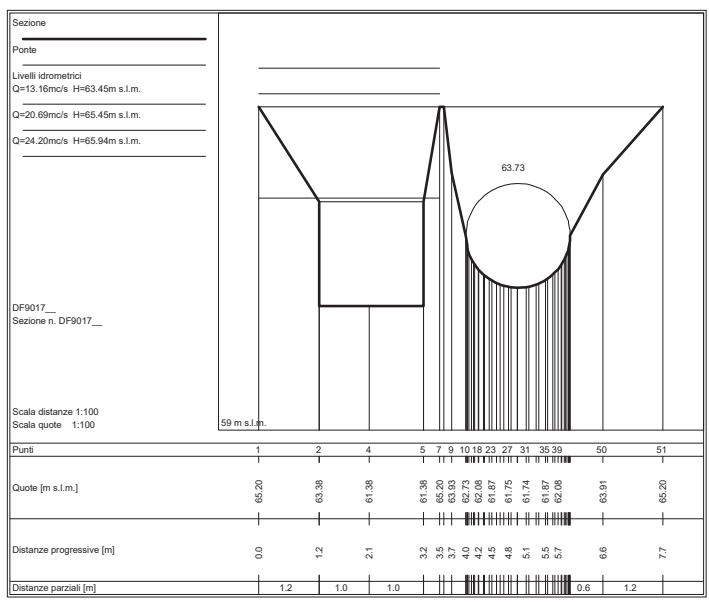
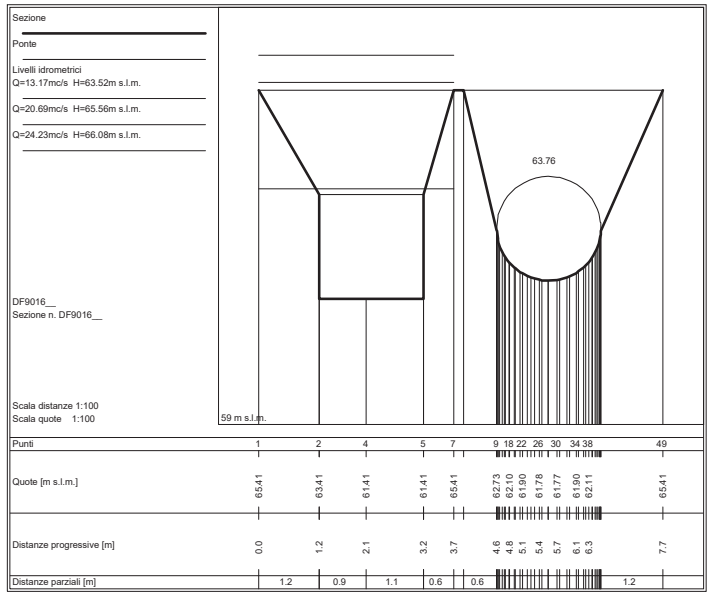



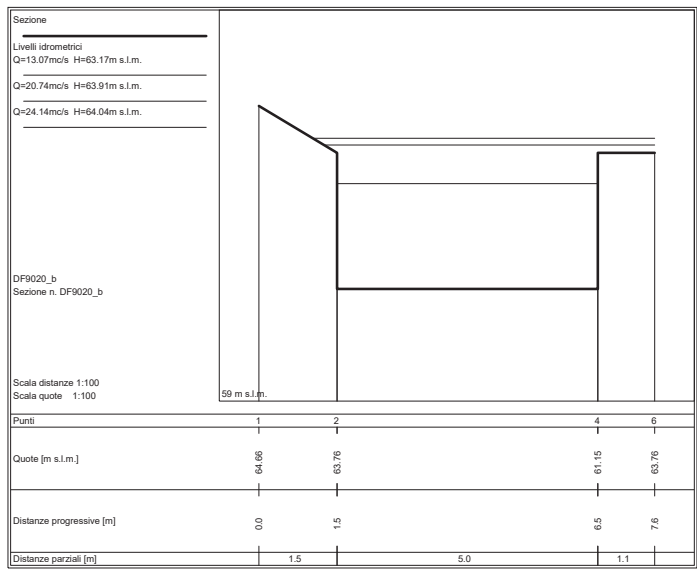
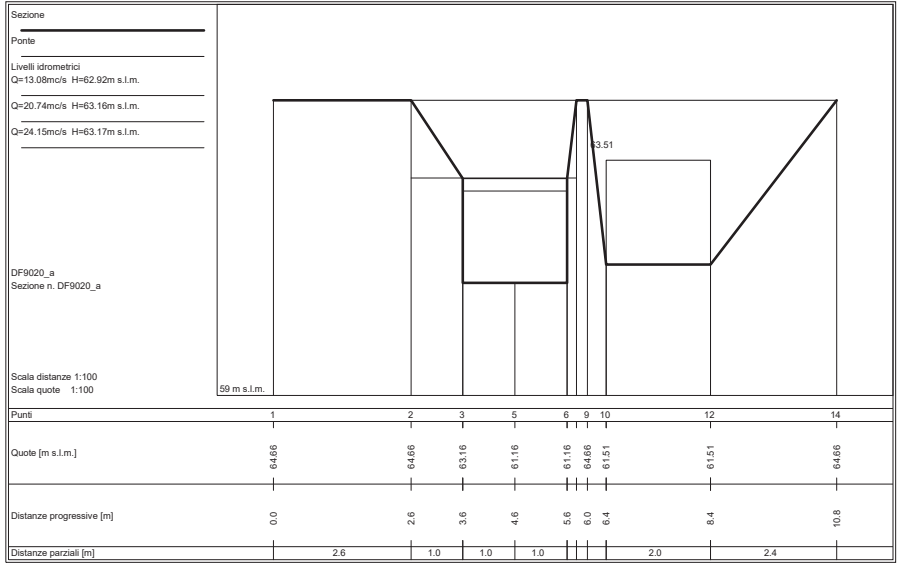

SEZIONI FLUVIALI  
FOSSO FUNANDOLA - TRATTO 2

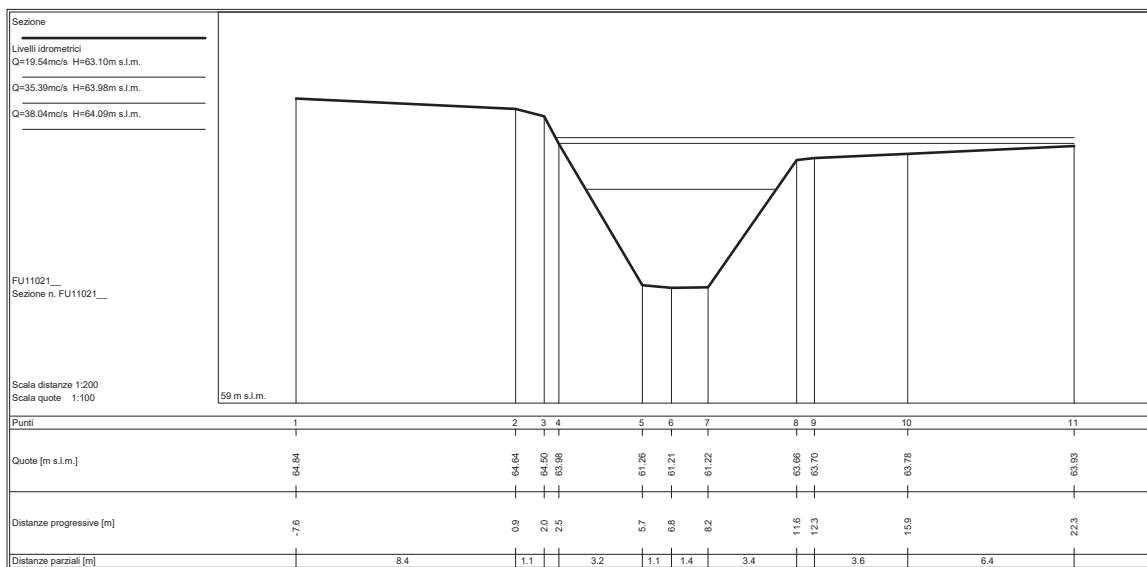
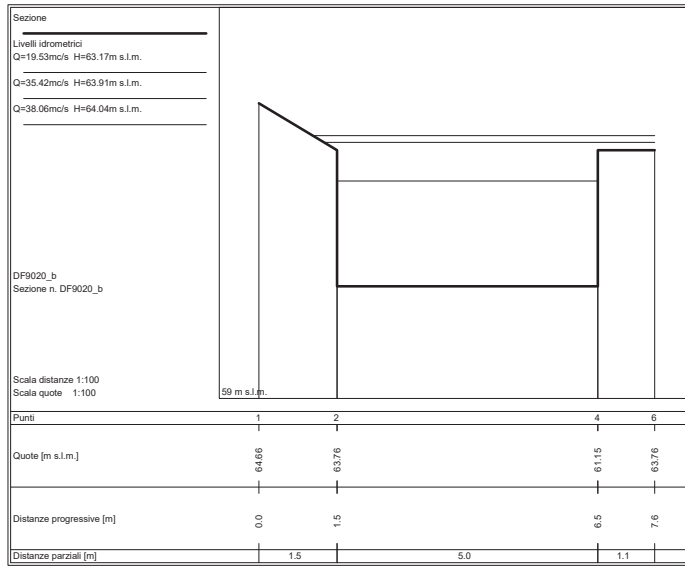

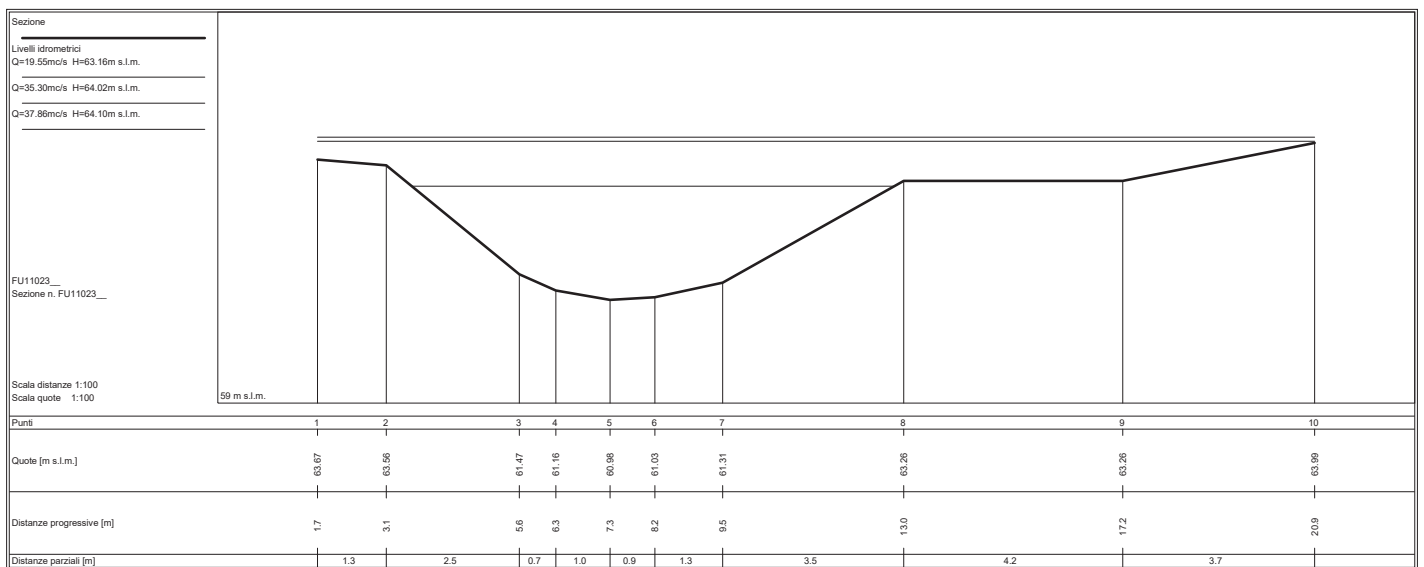
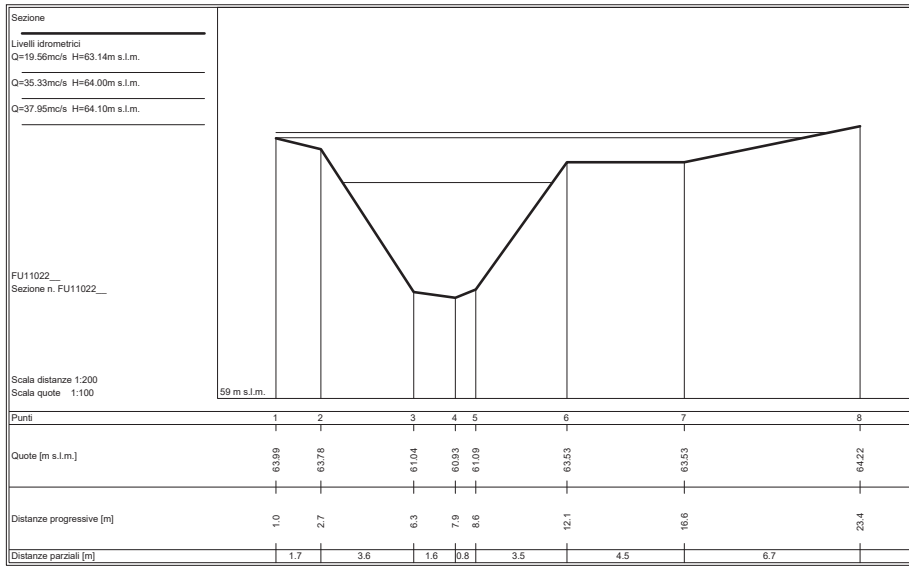

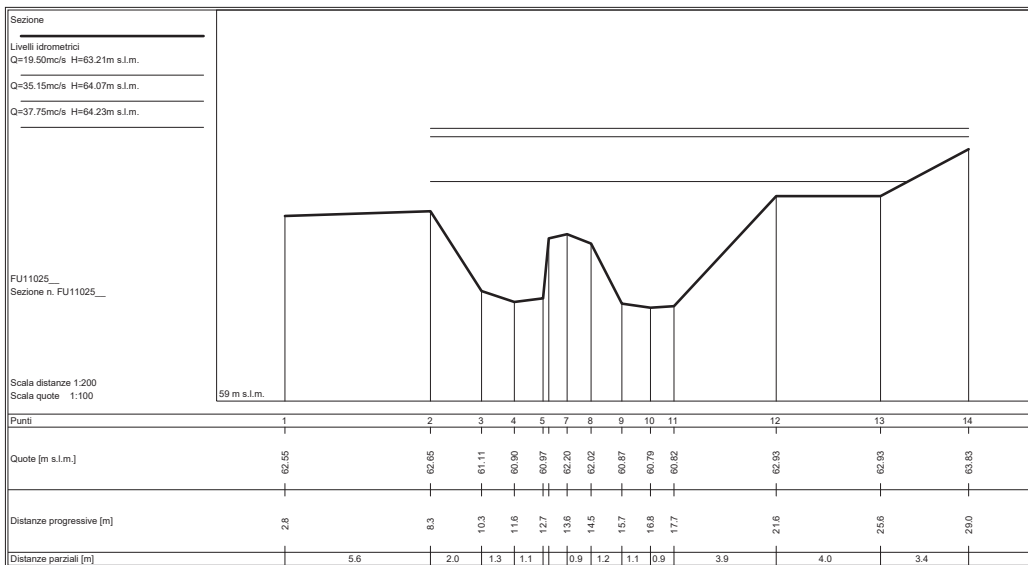
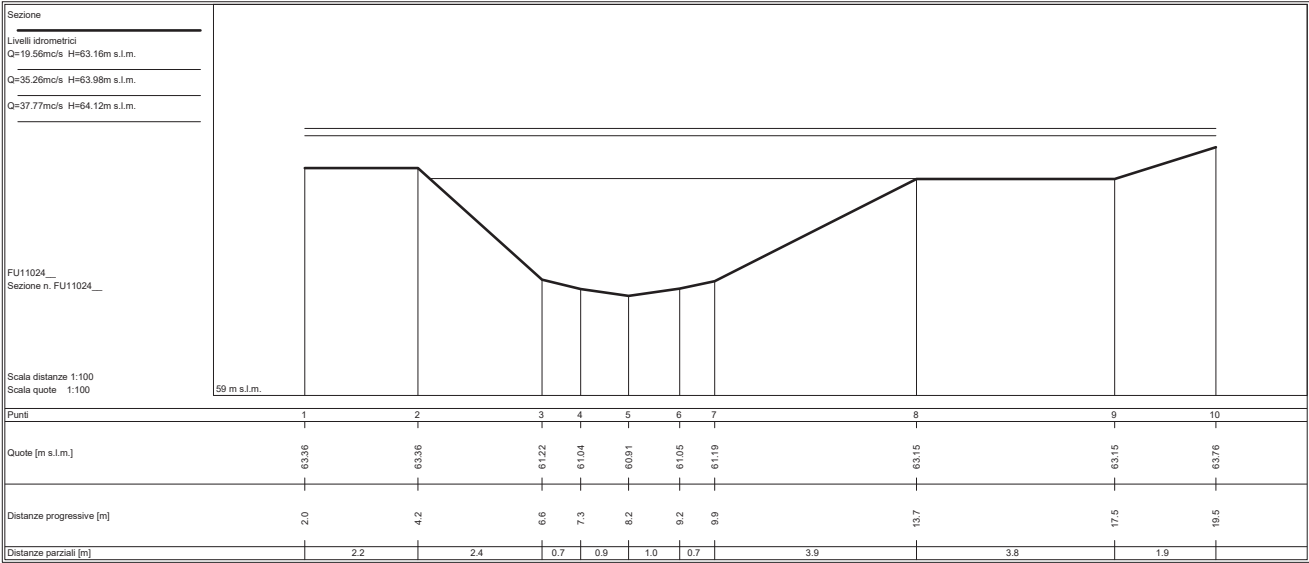

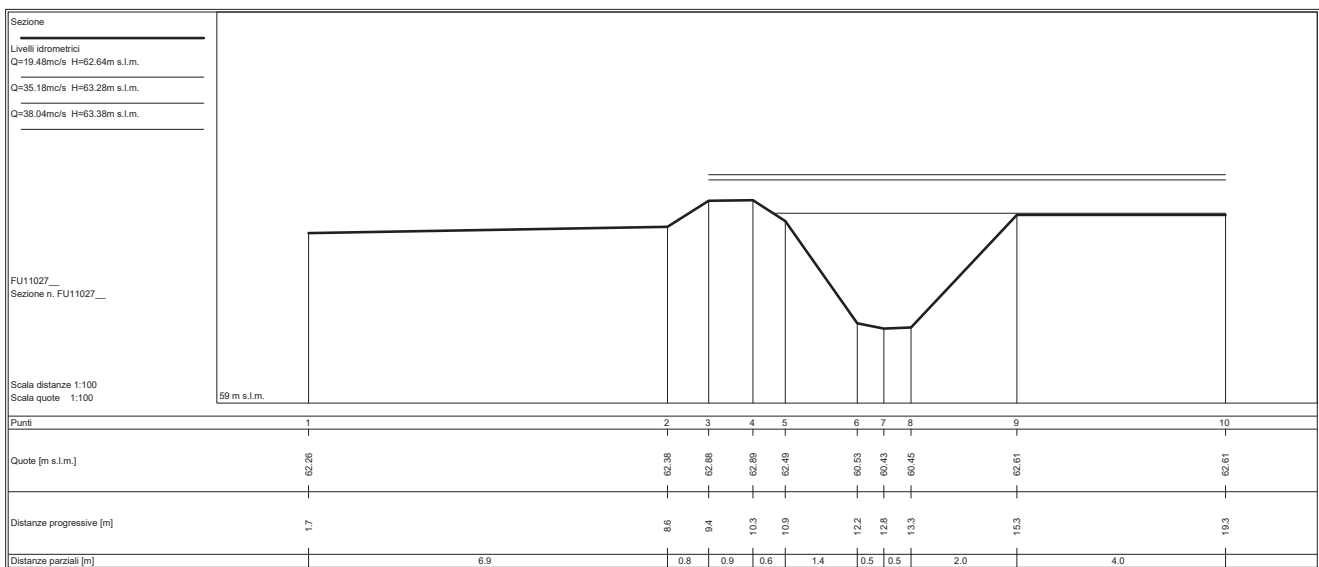
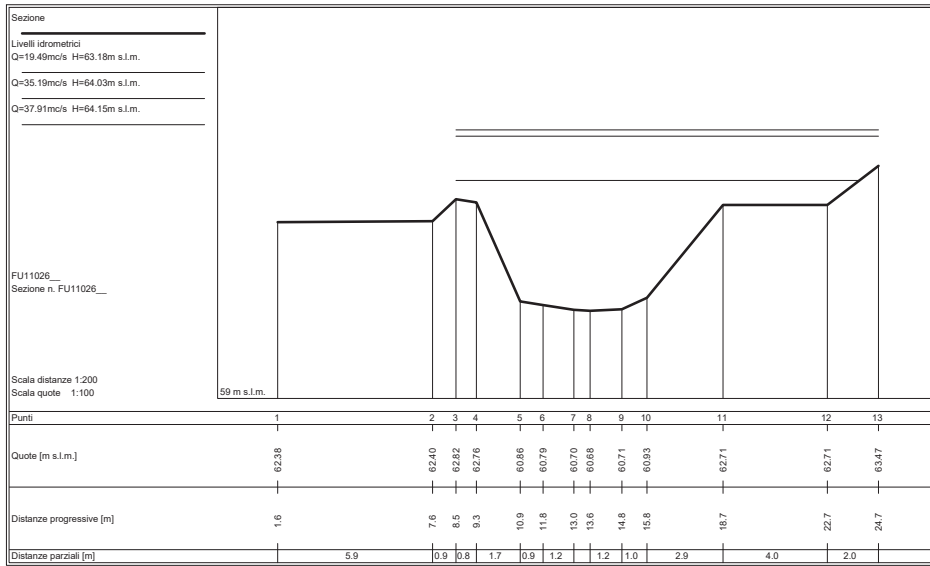



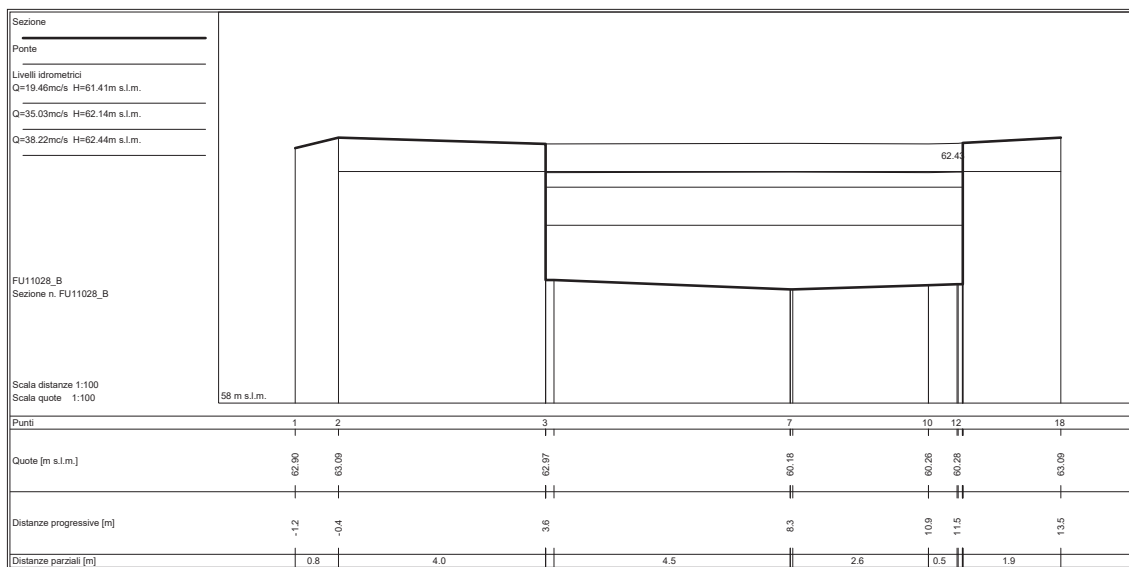
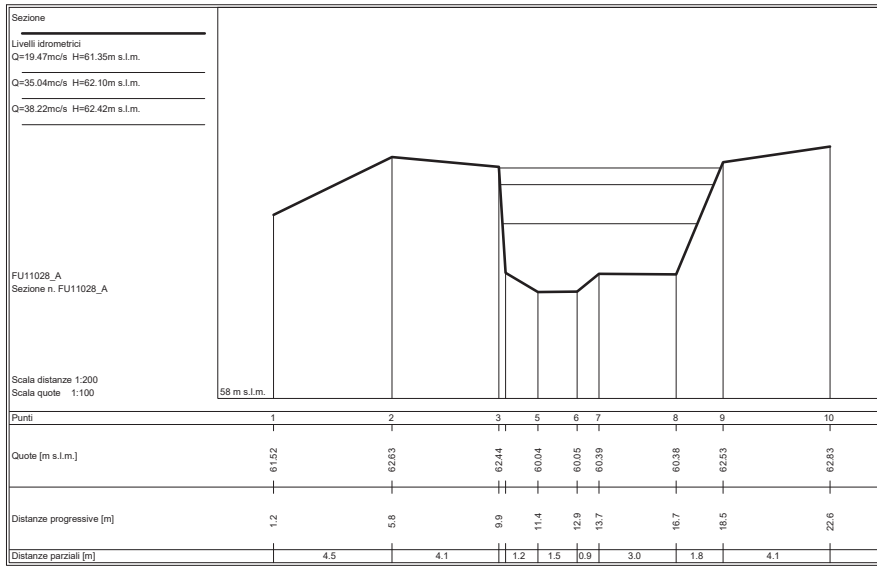

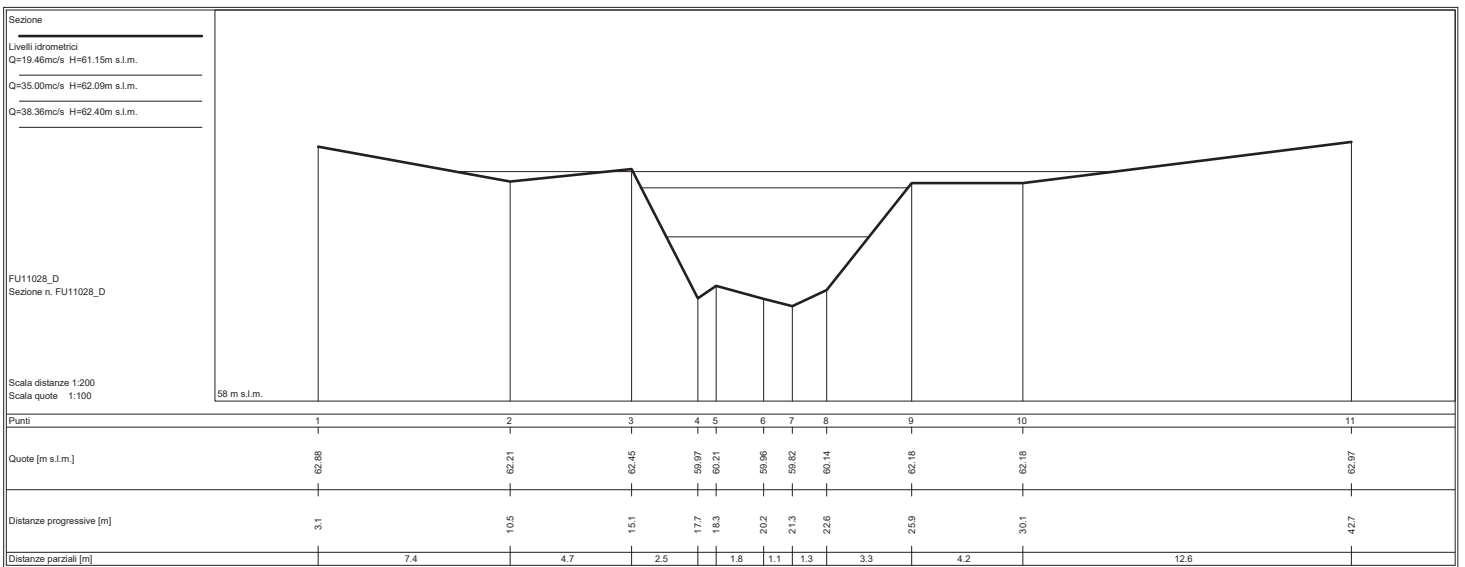
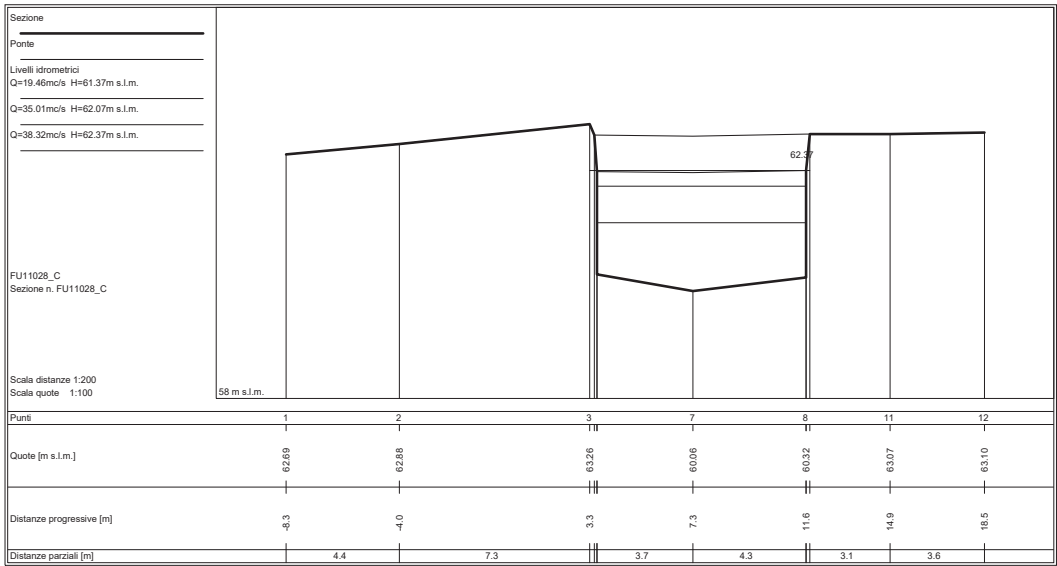

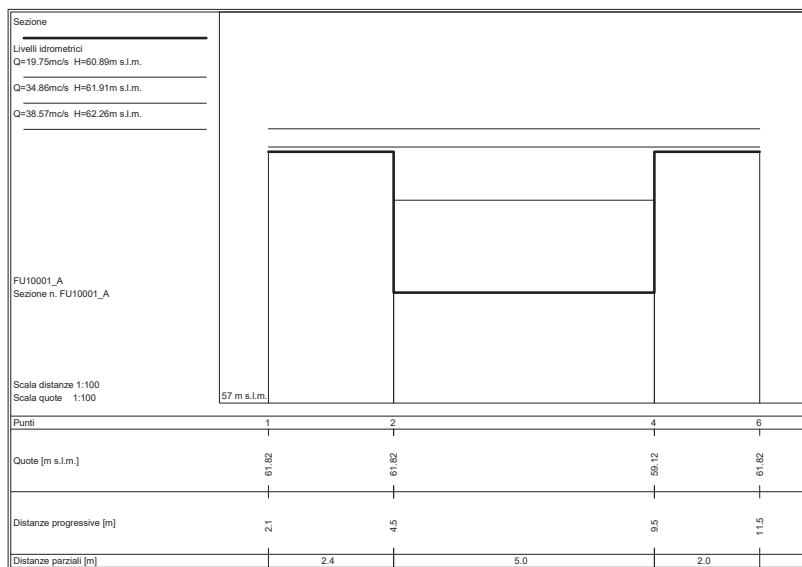
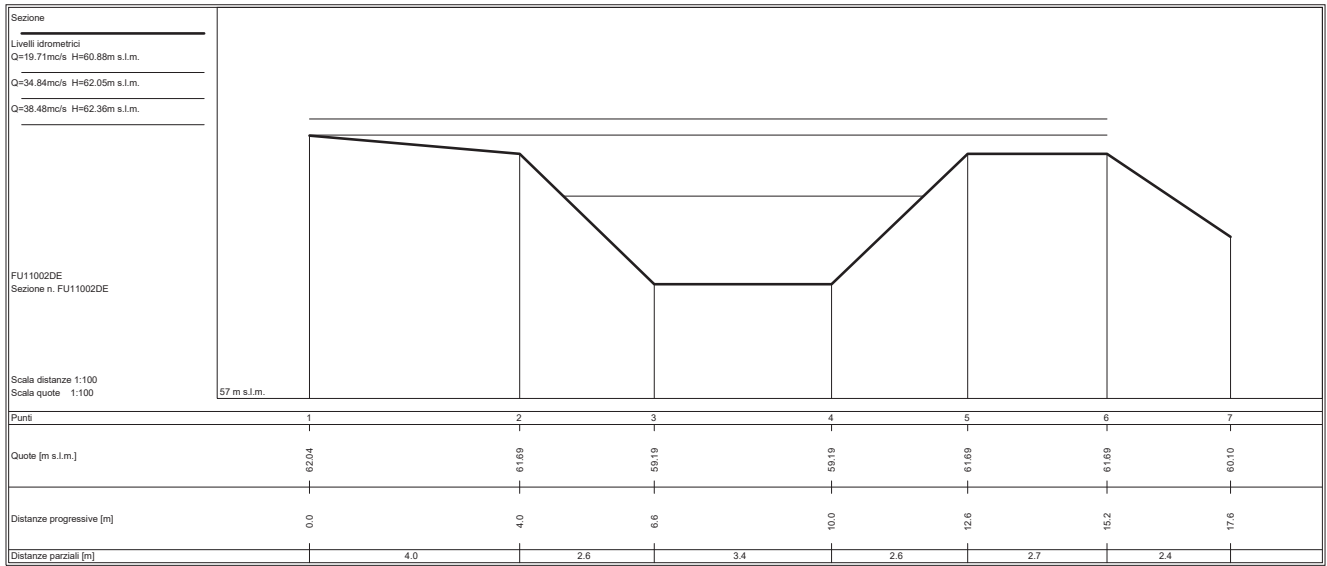

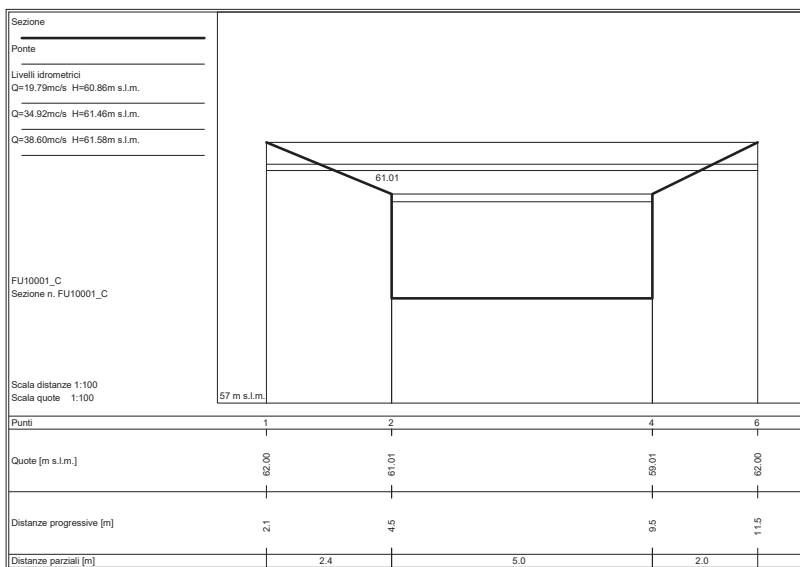
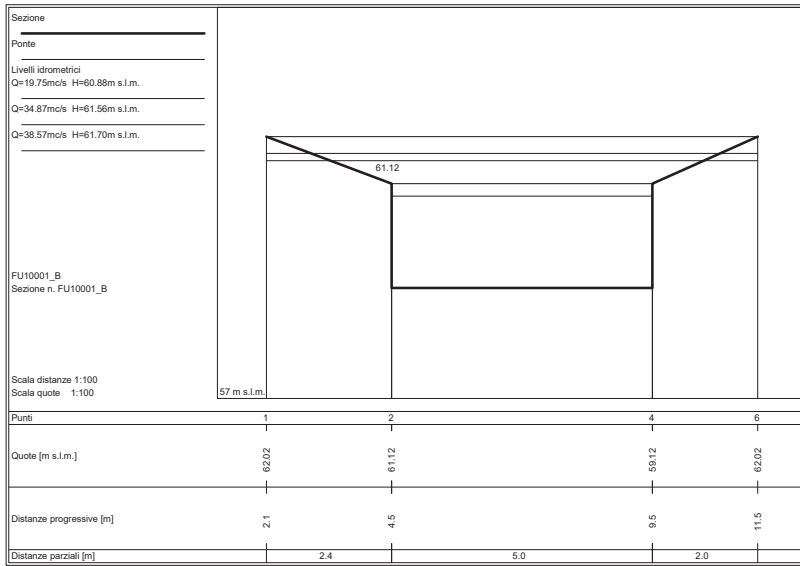

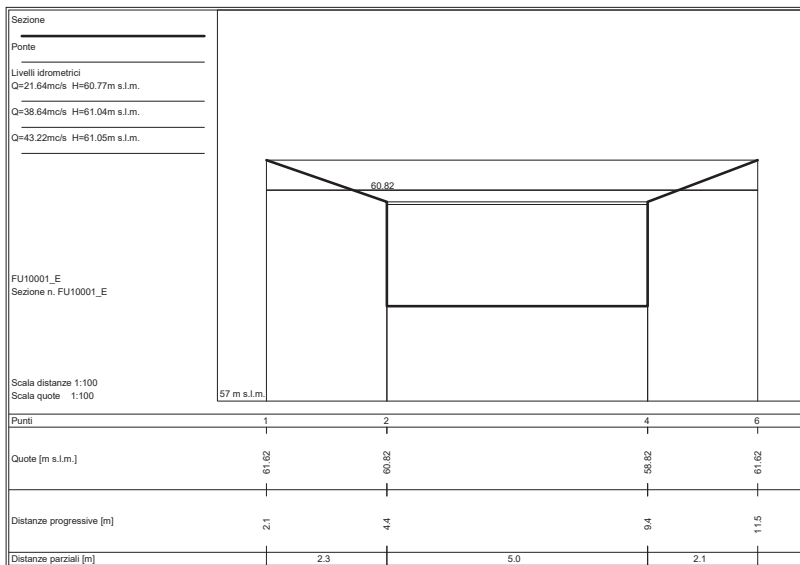
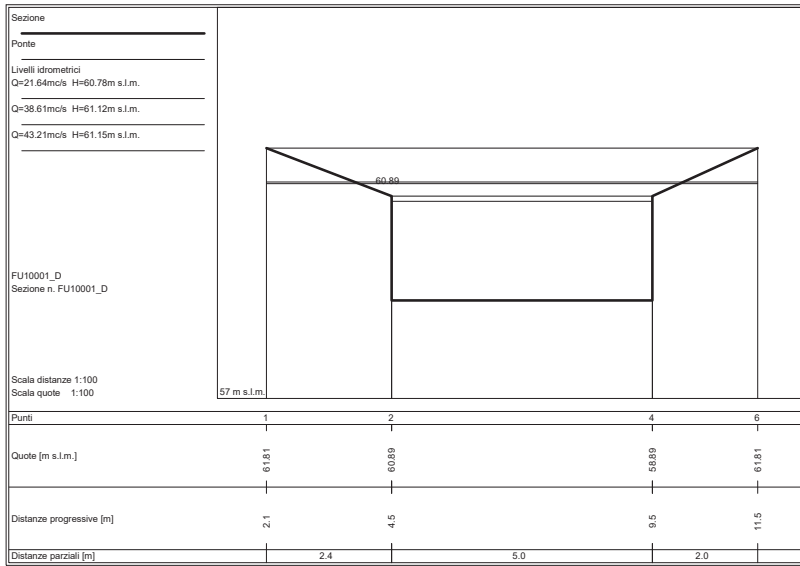

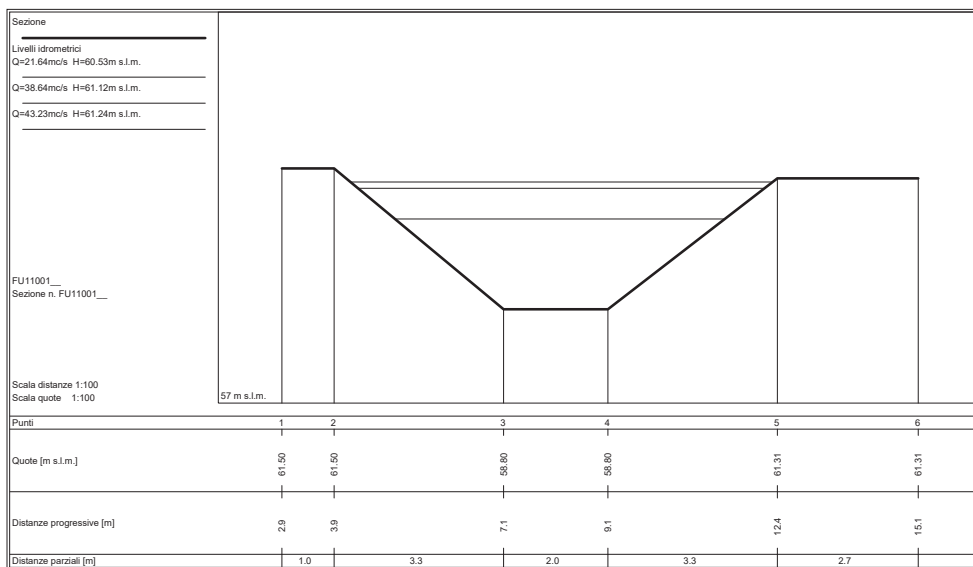
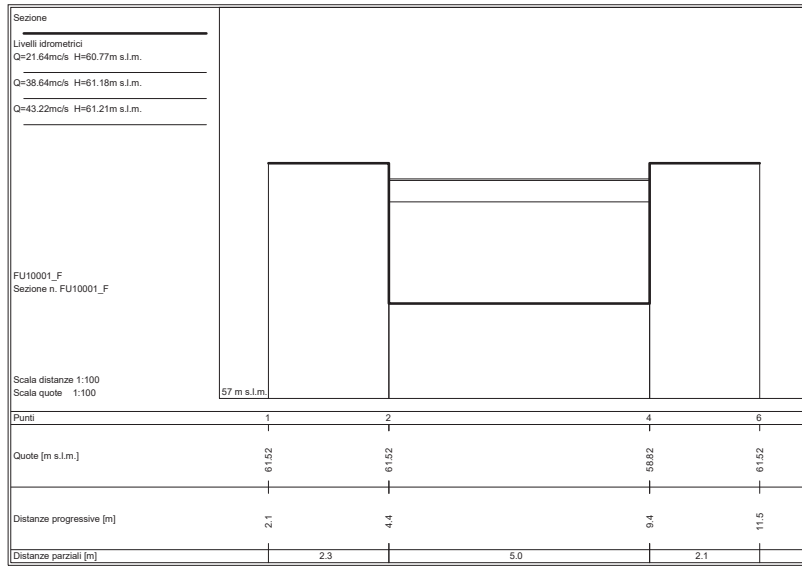

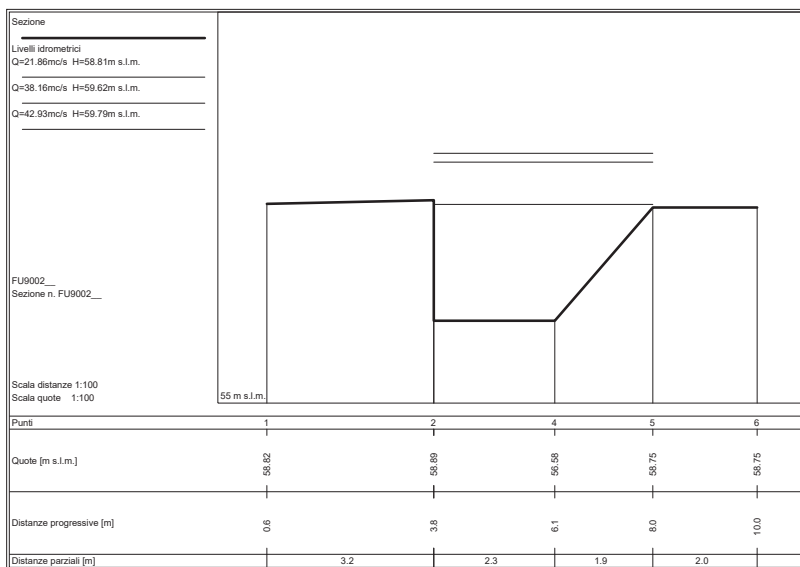
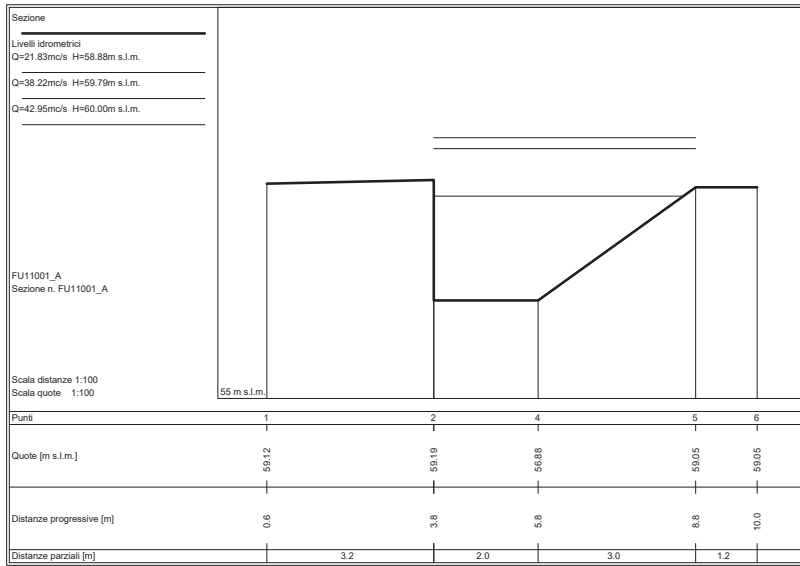

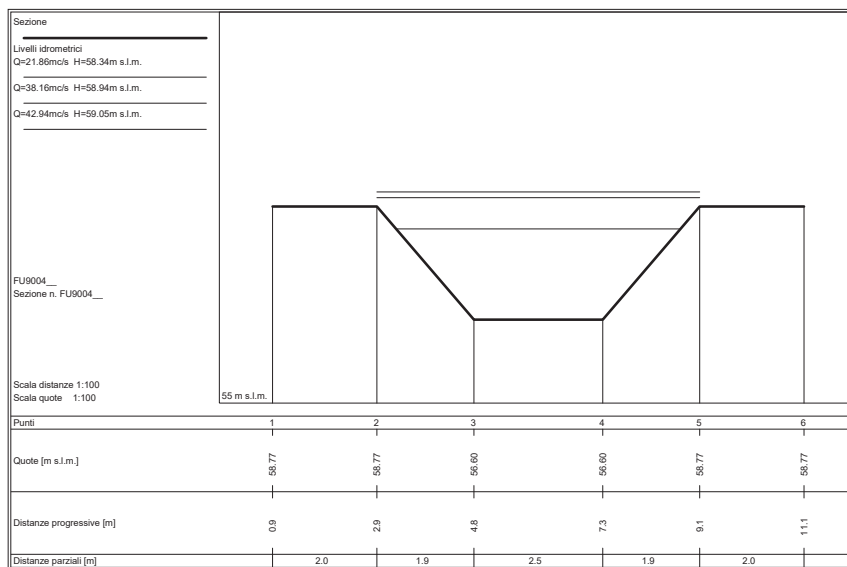
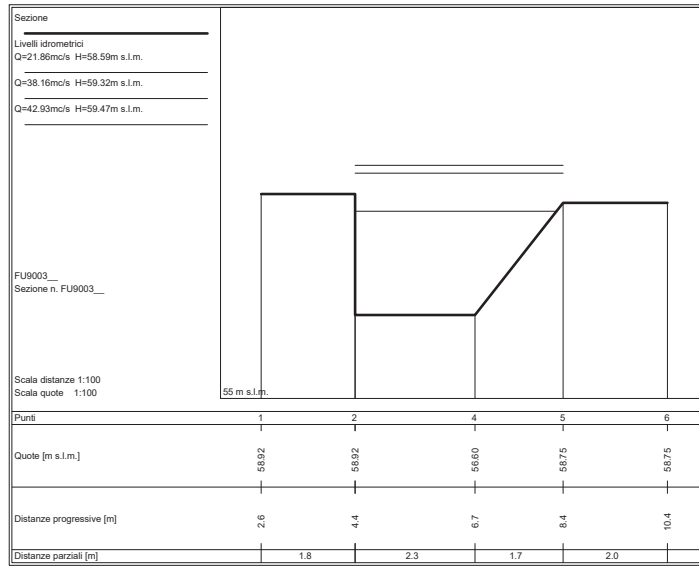



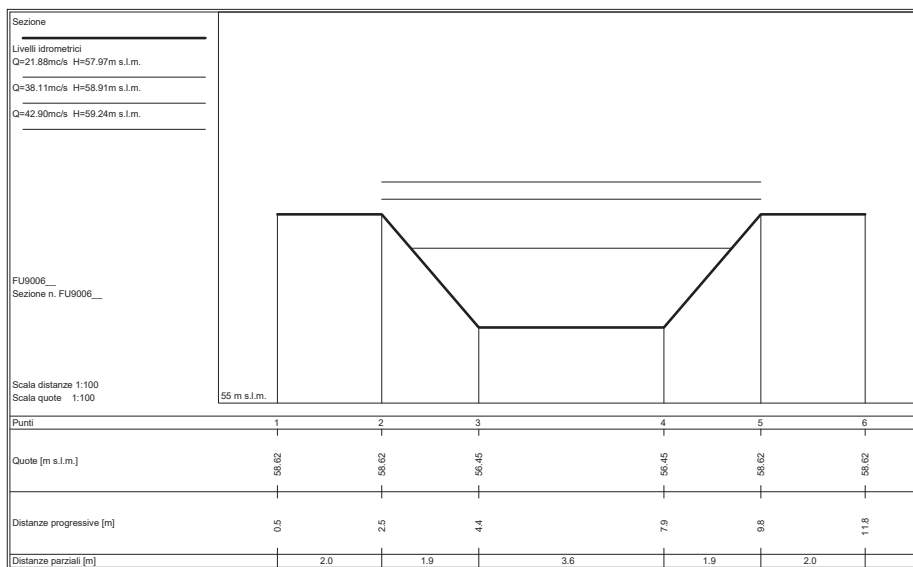
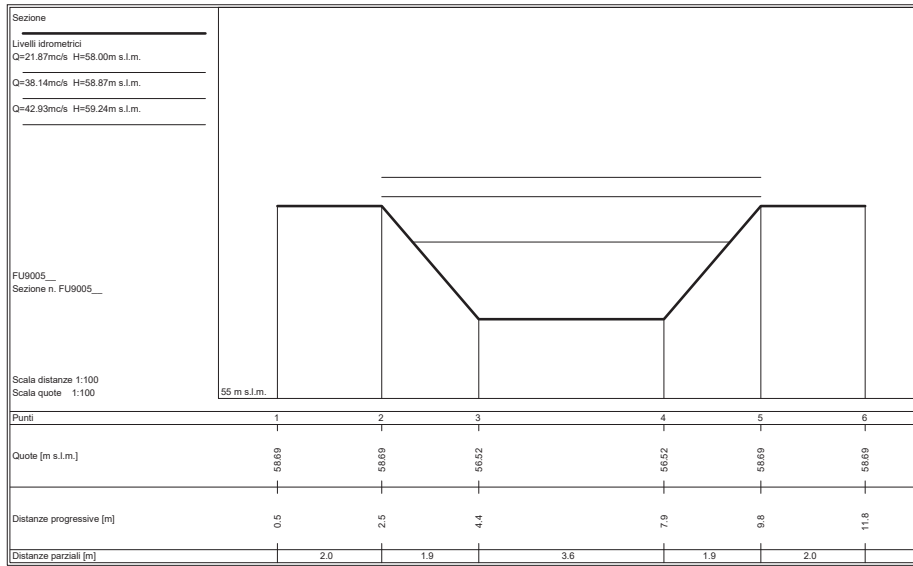

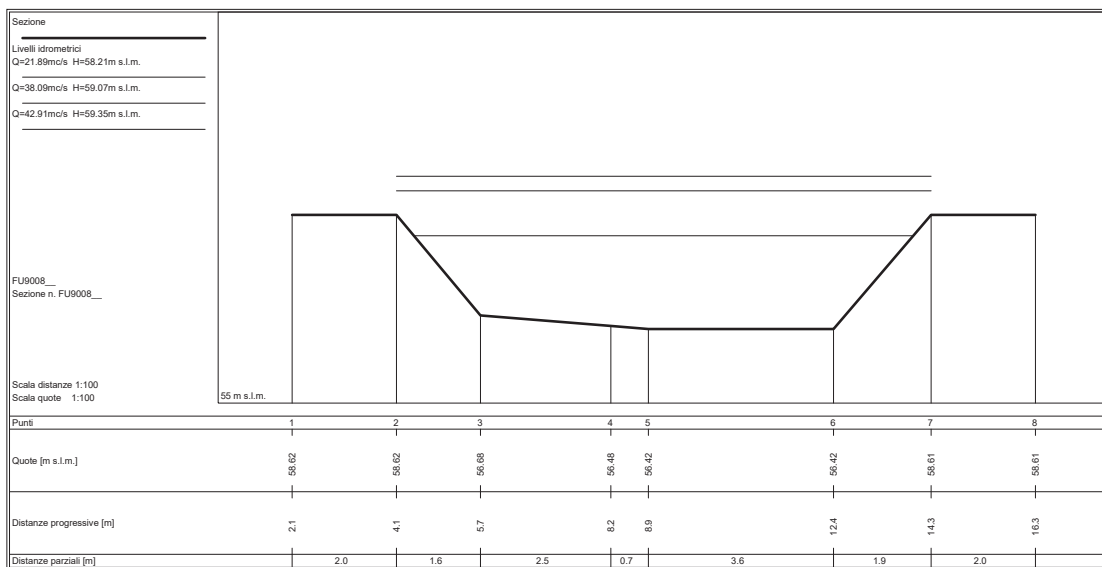
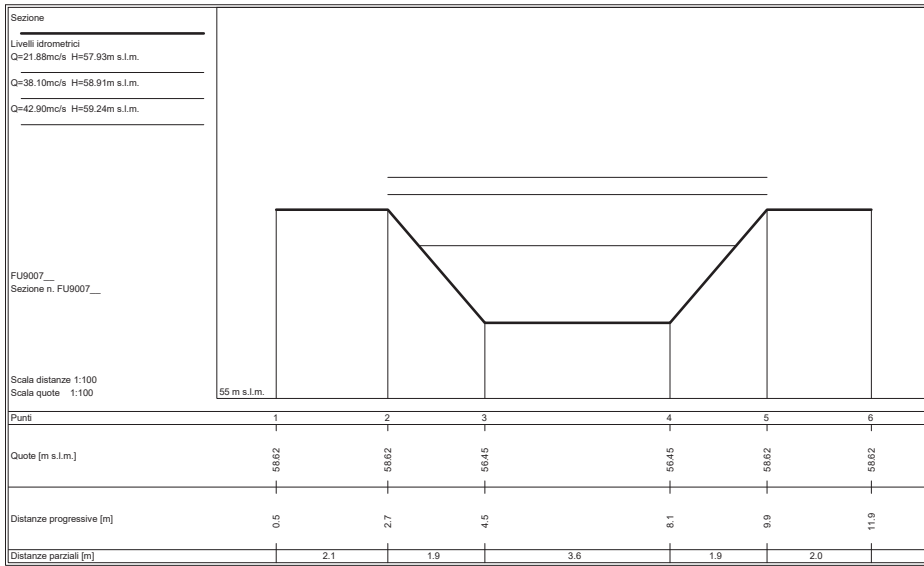

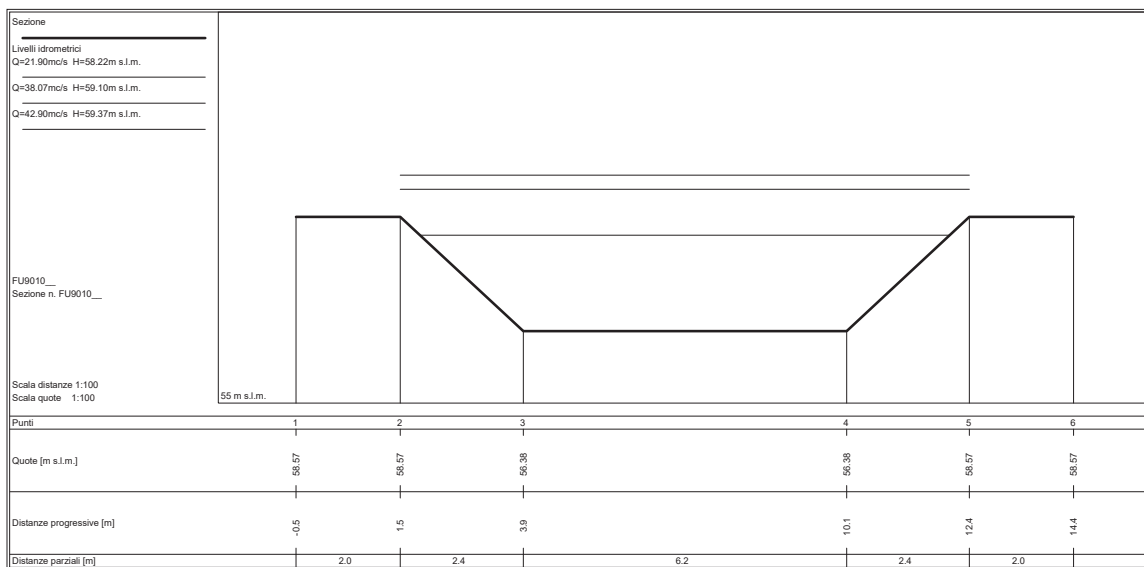
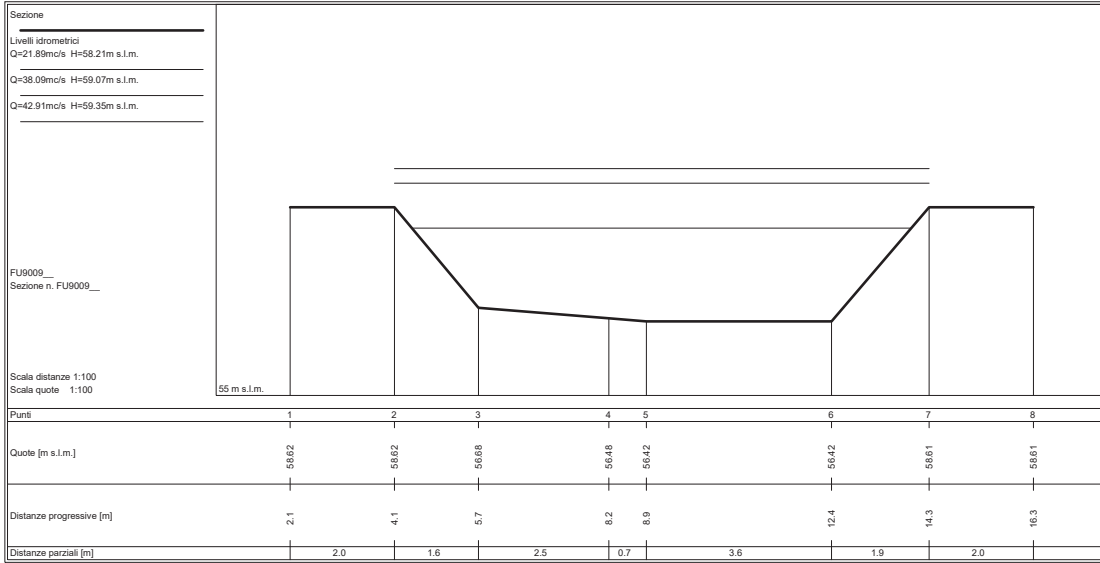

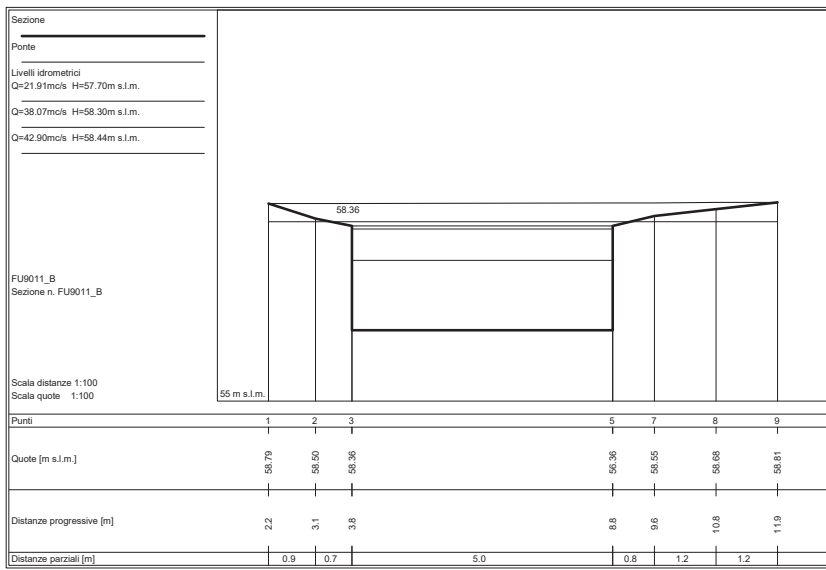
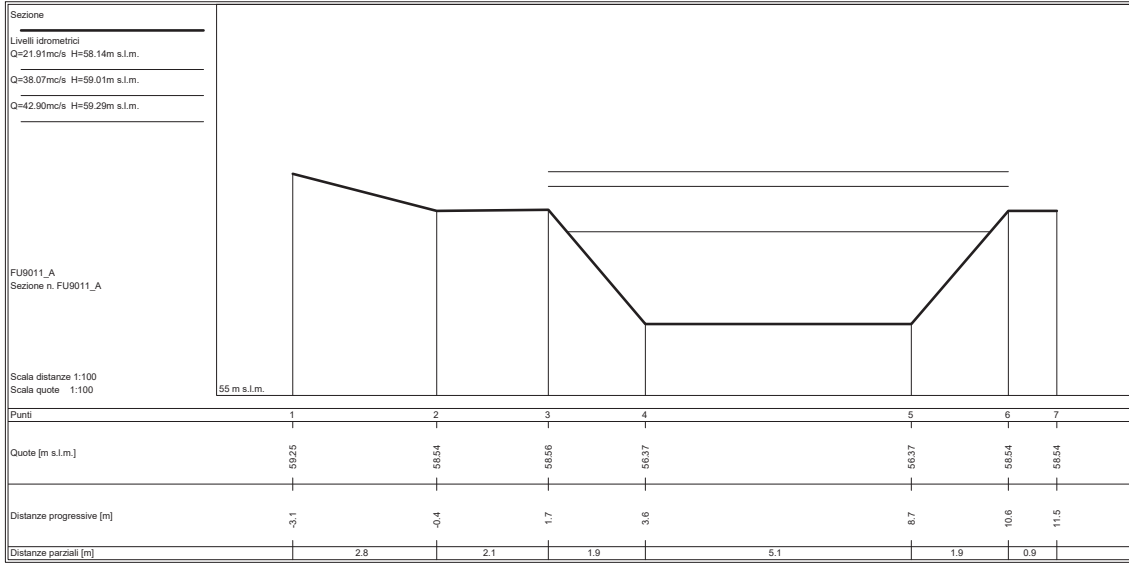

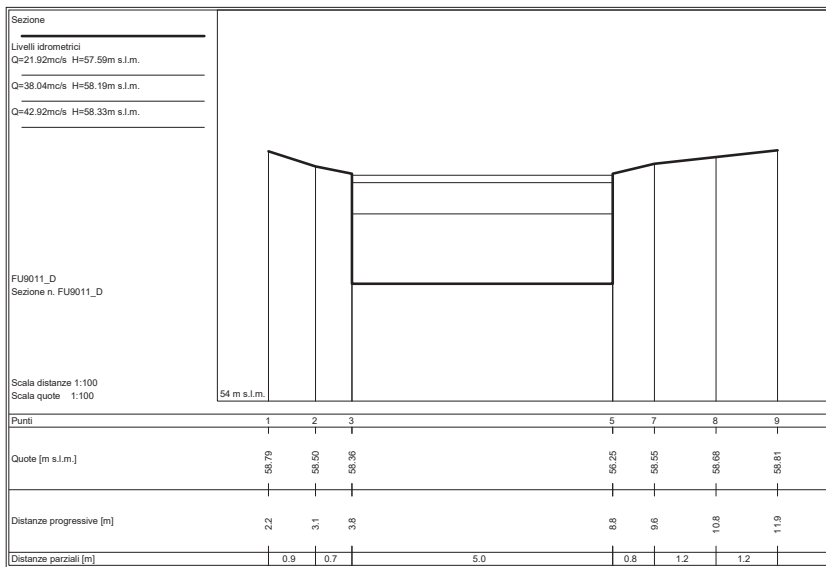
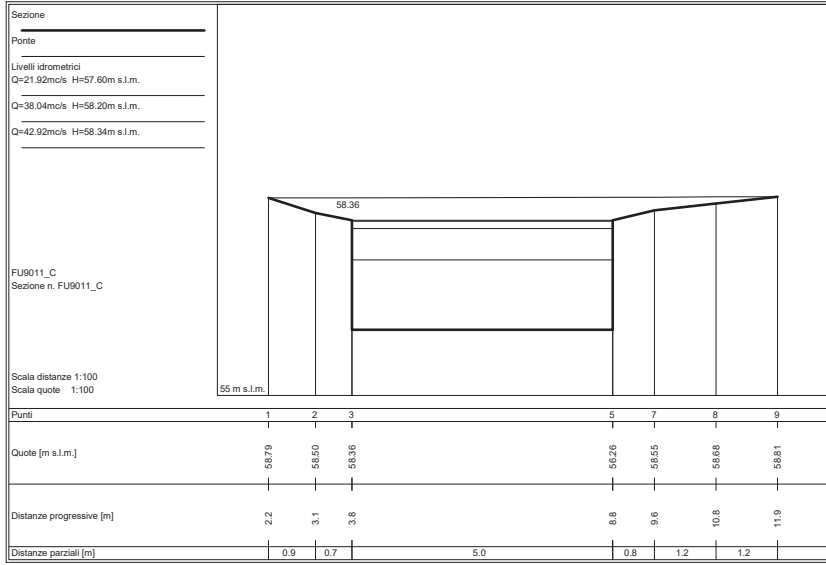

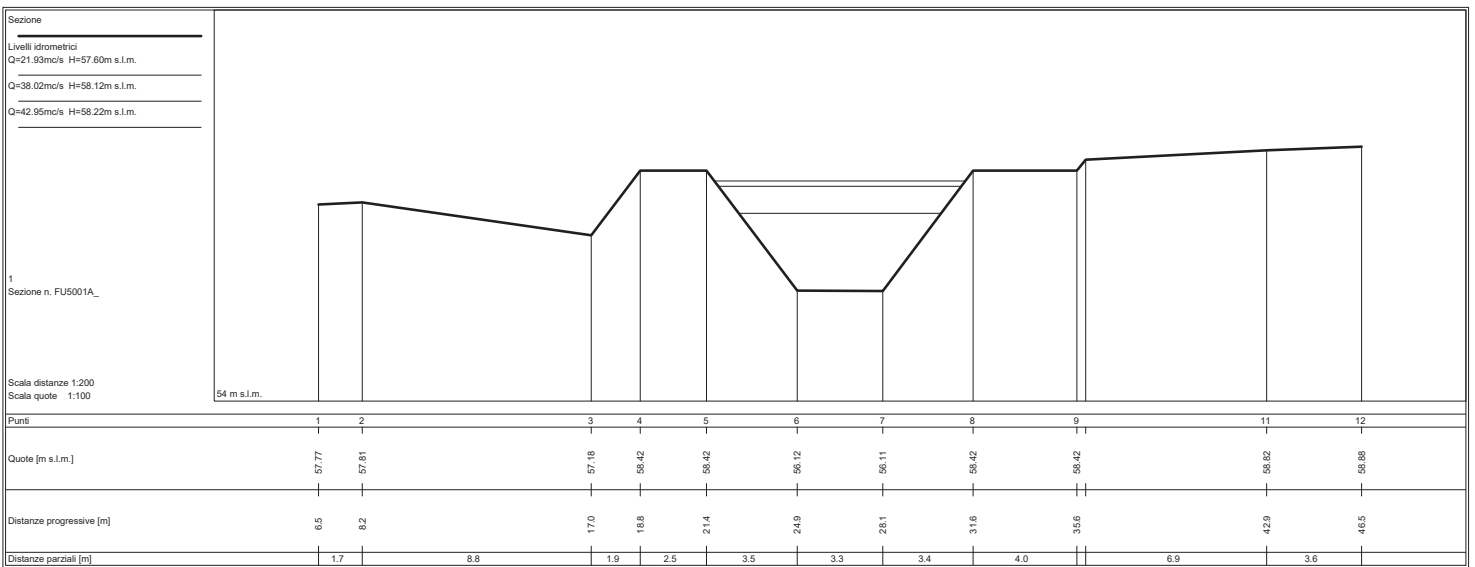
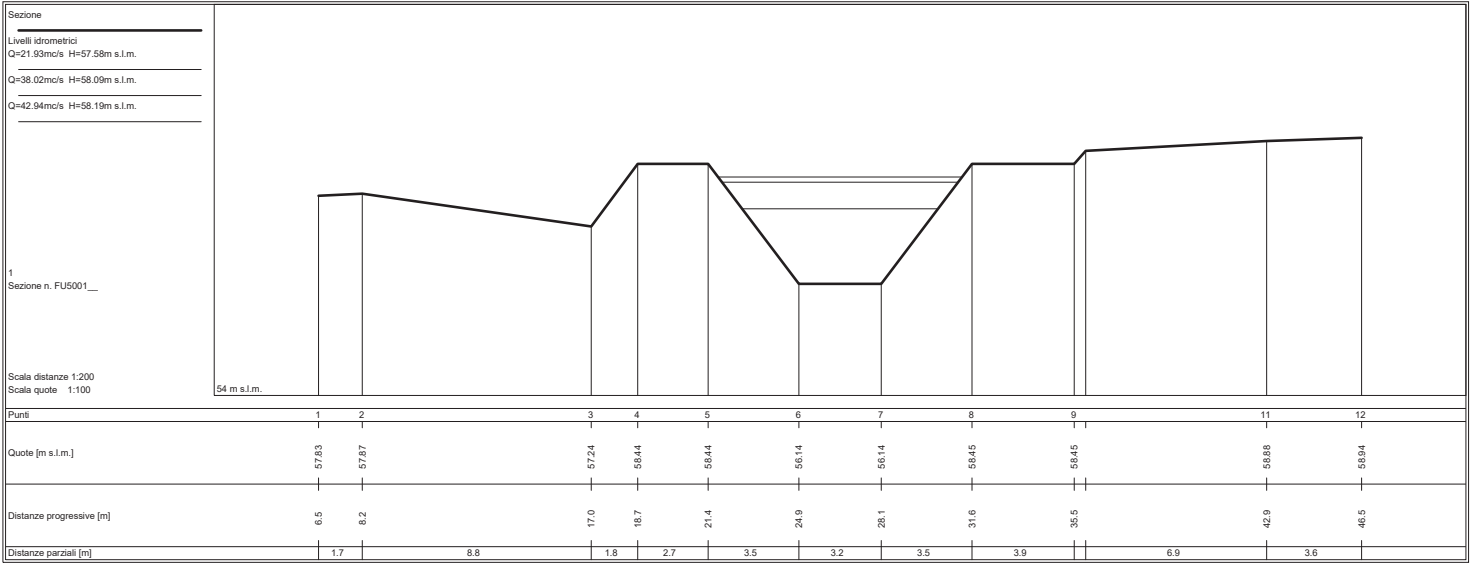

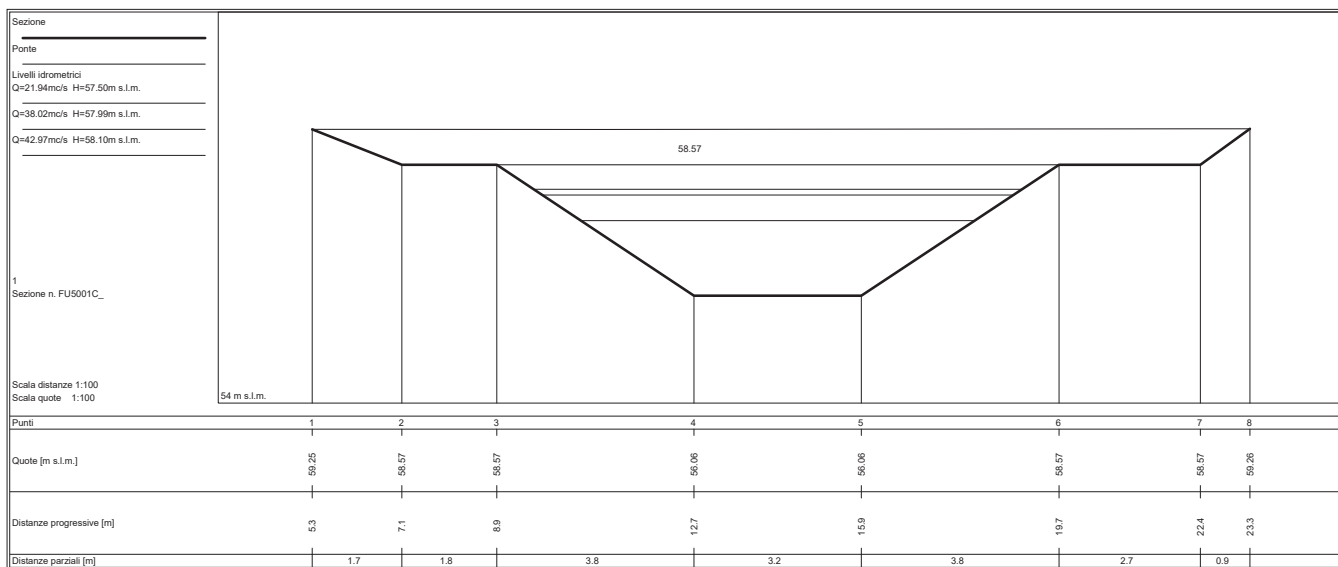
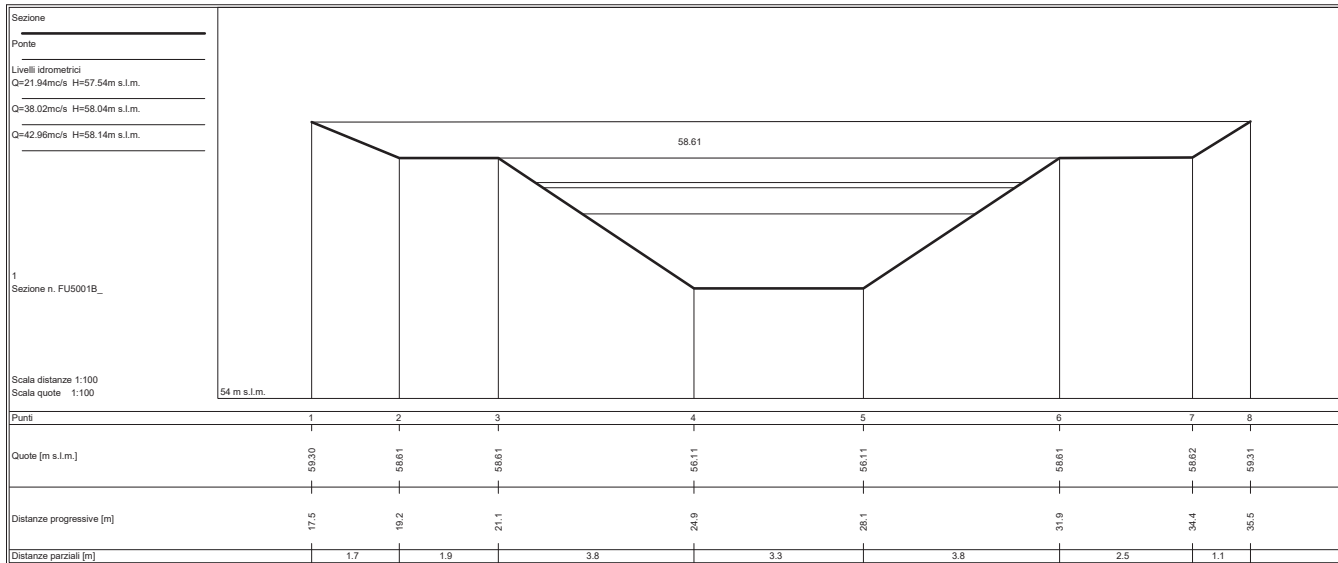

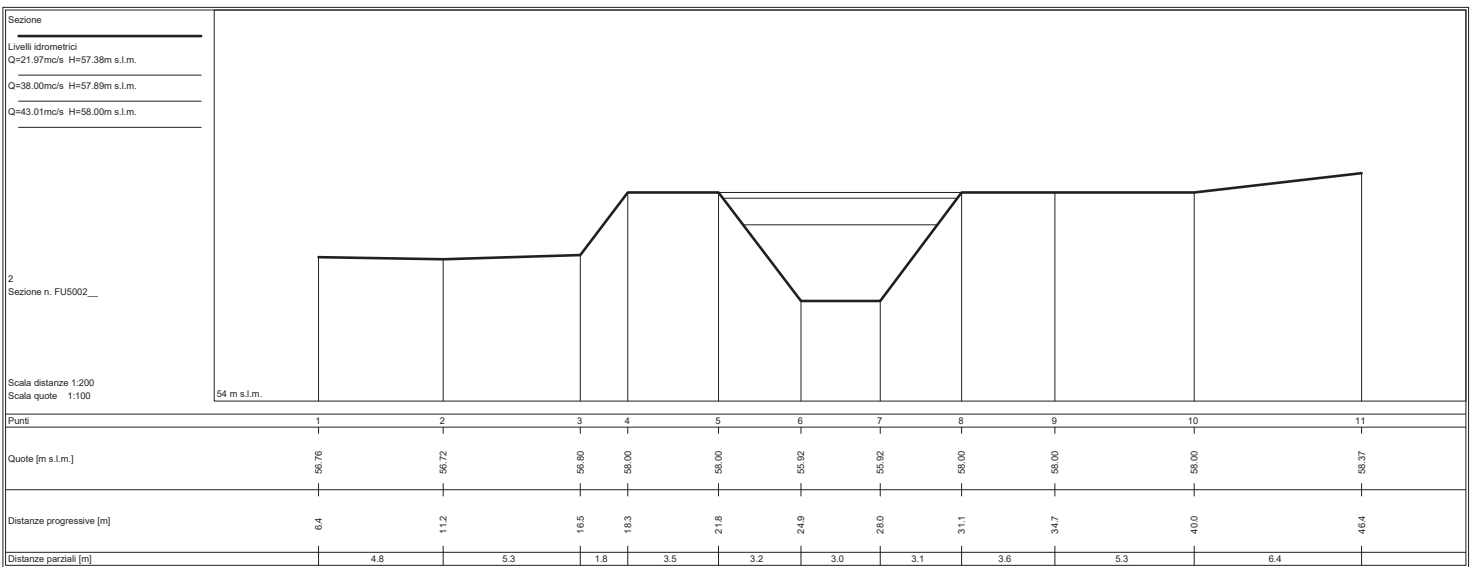
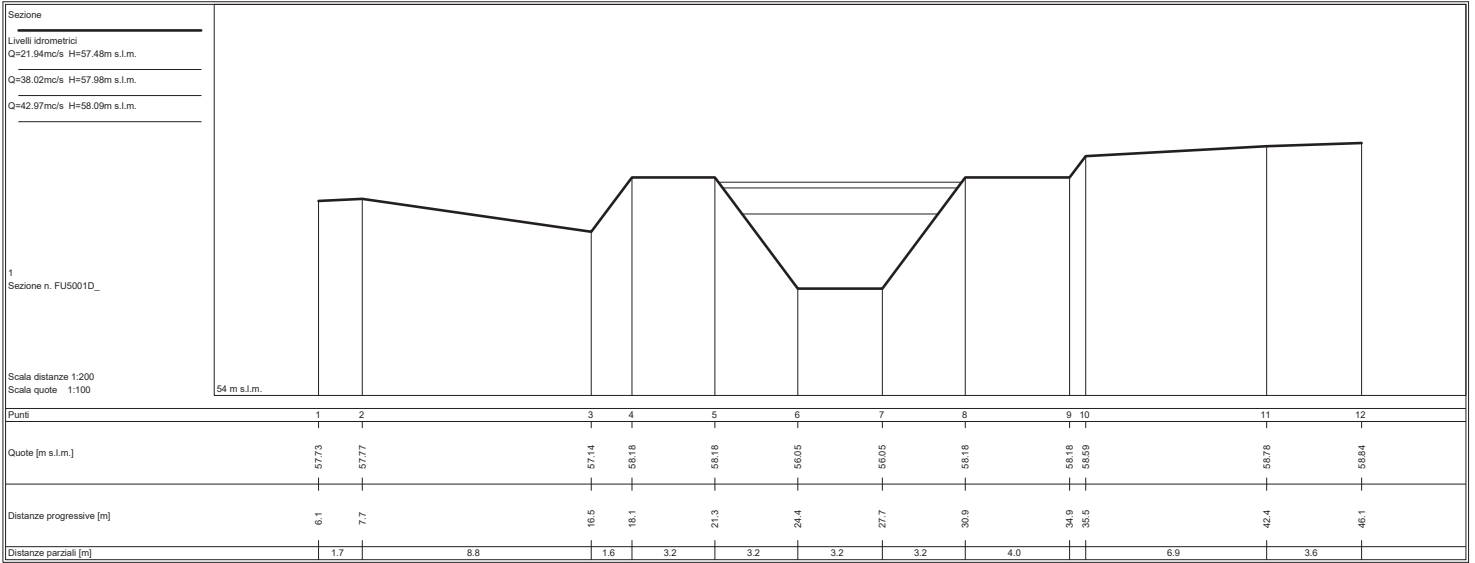



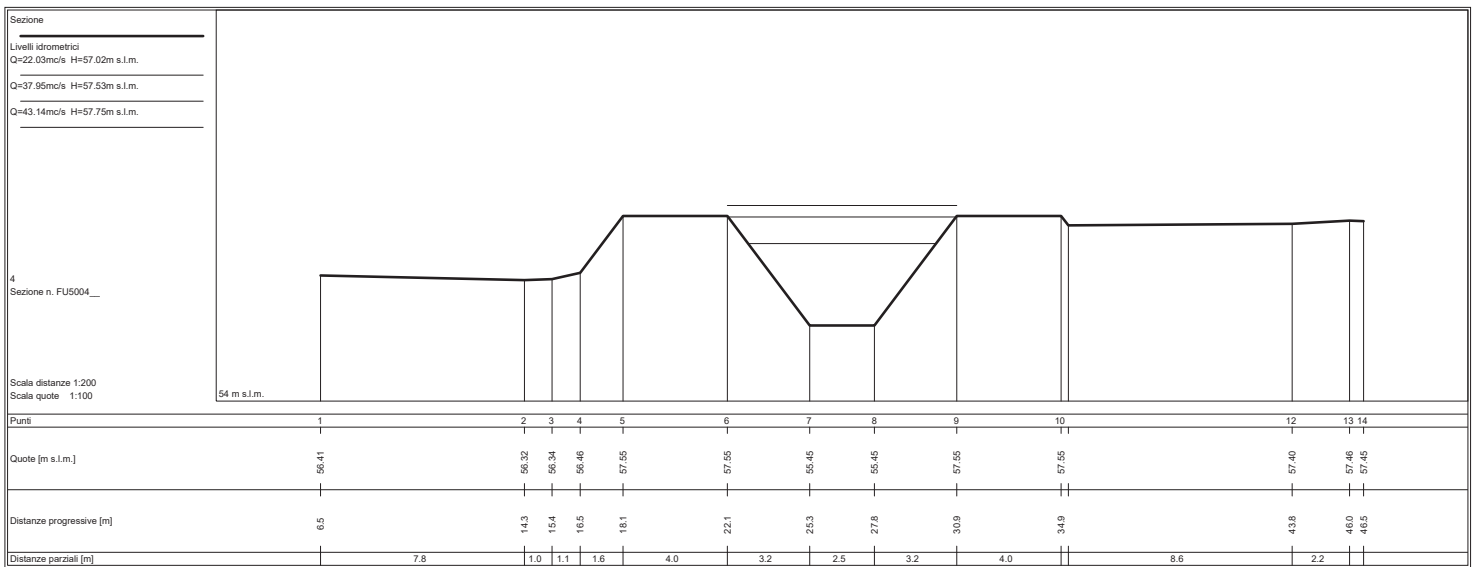
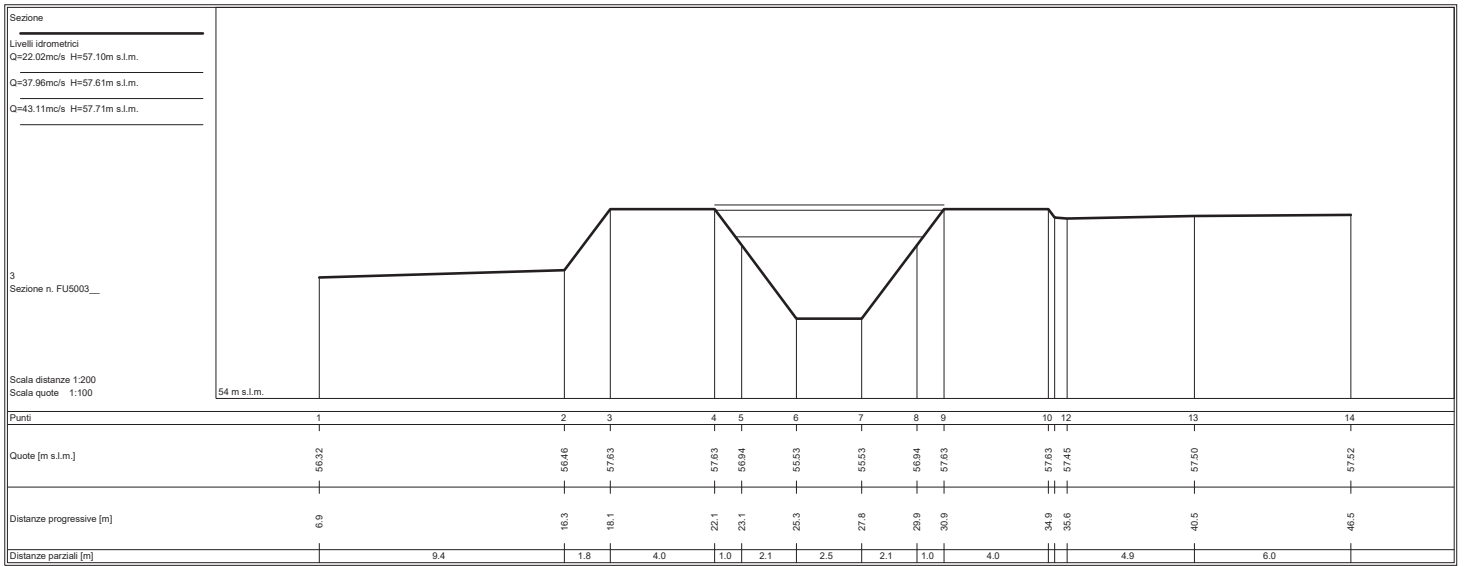

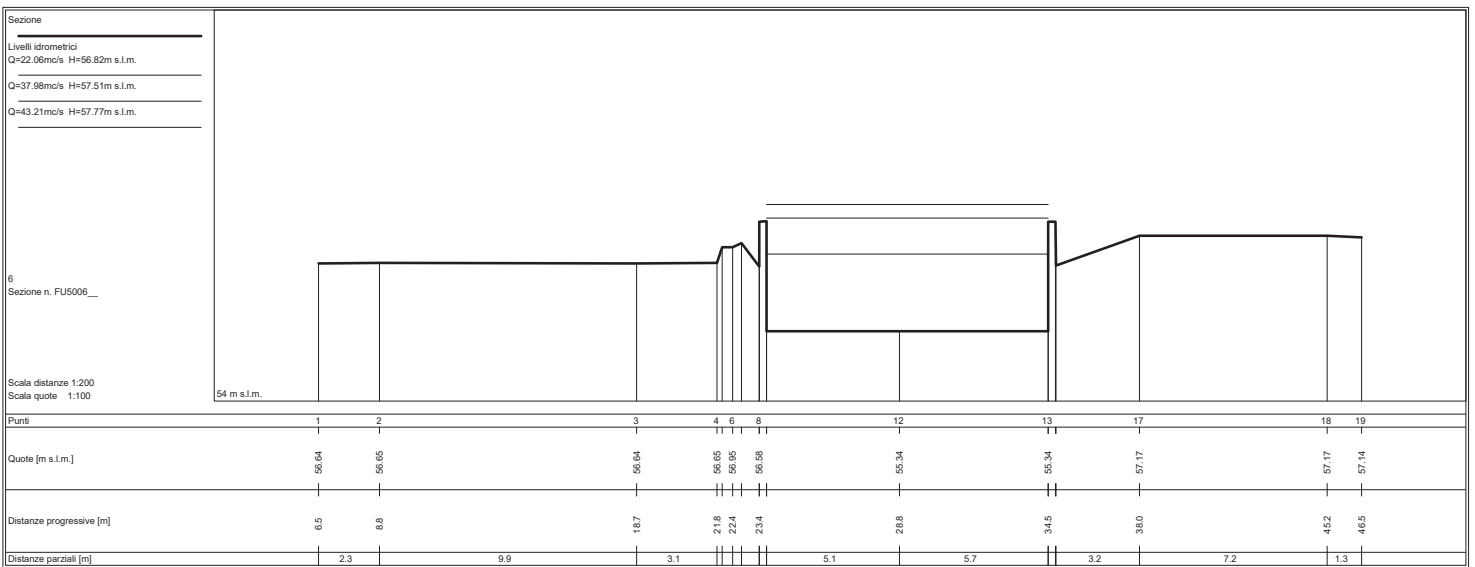
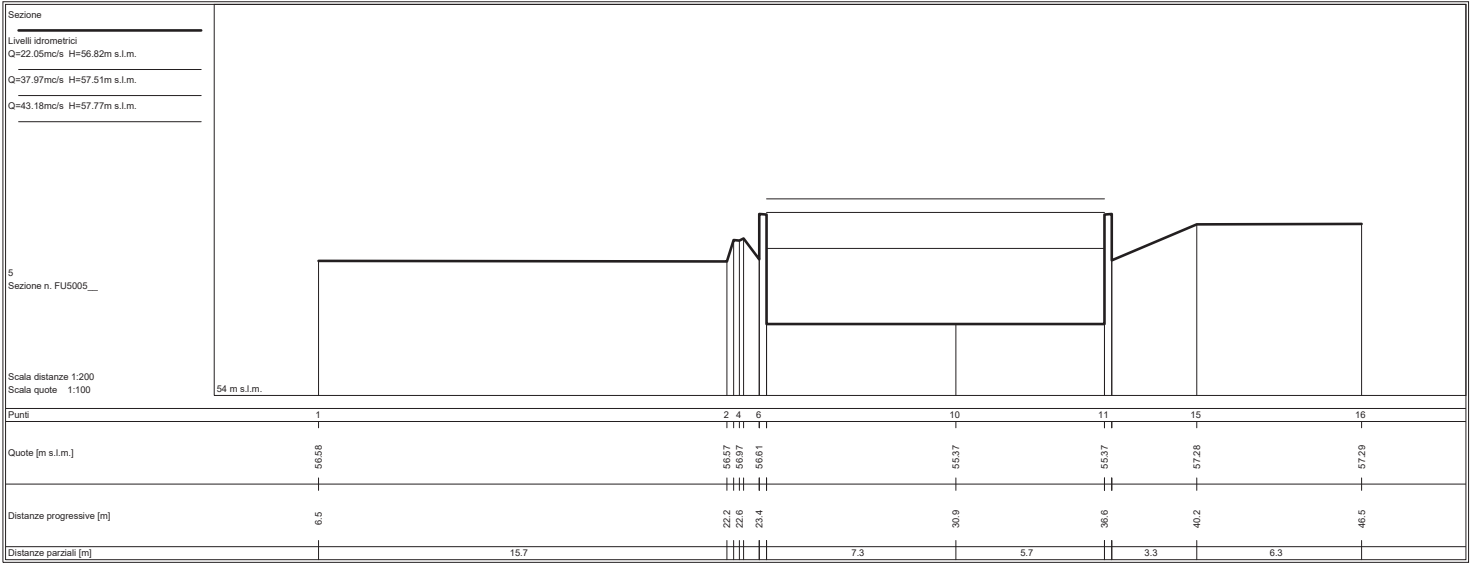

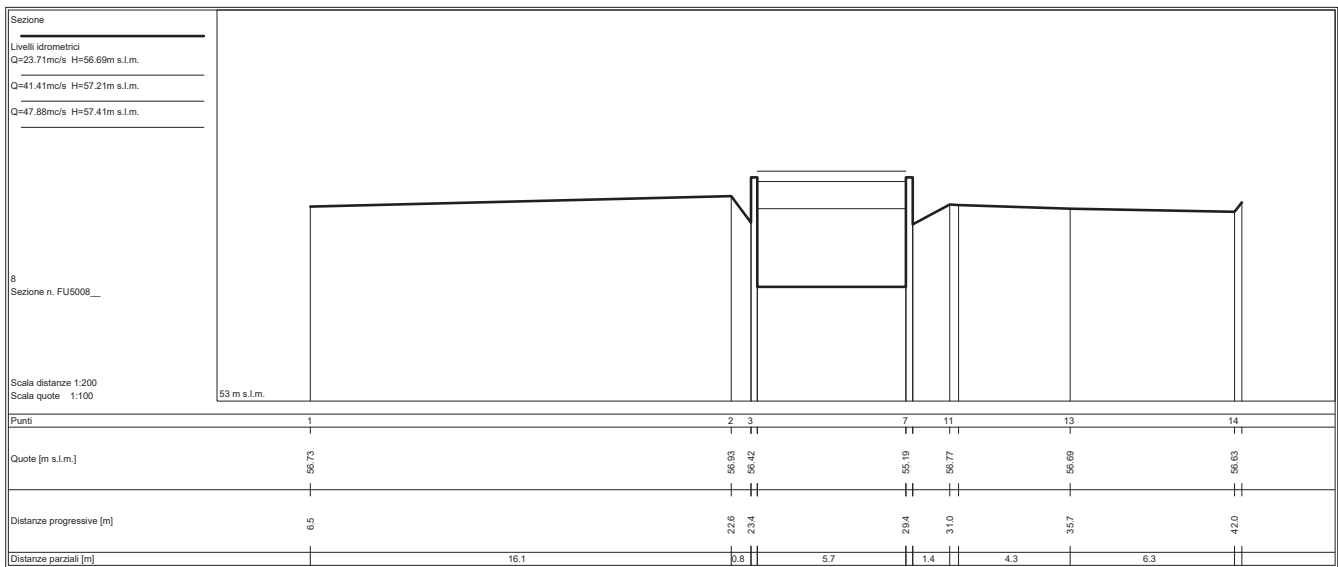
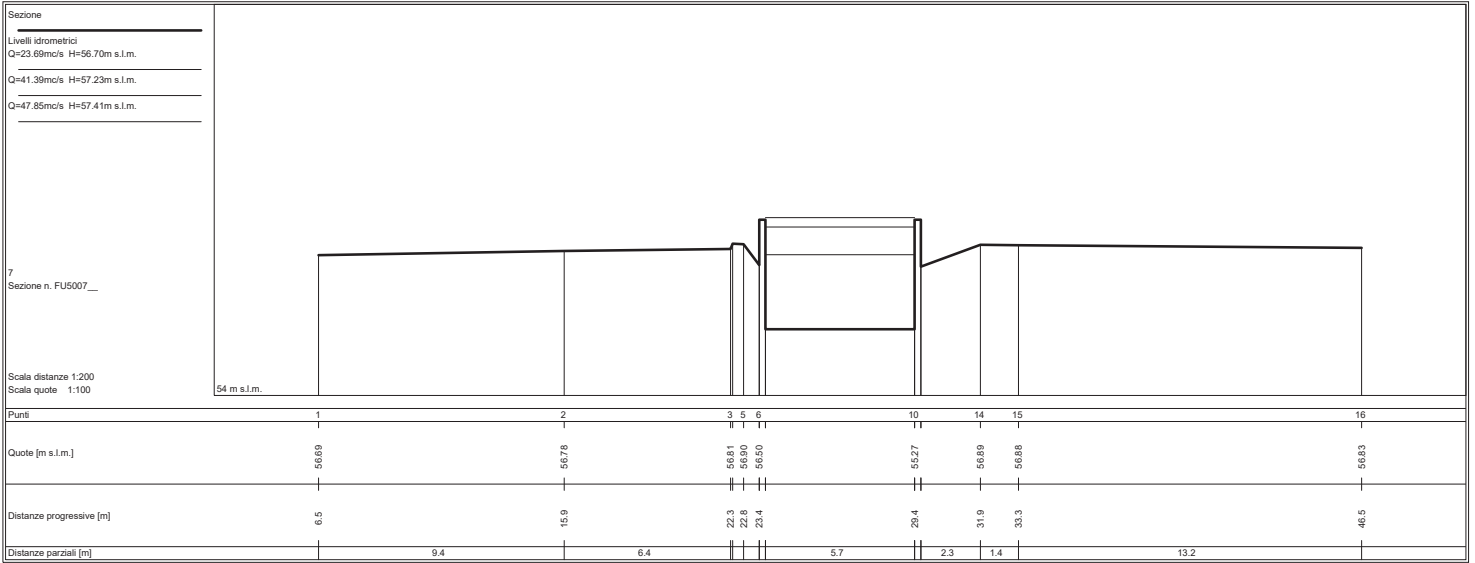

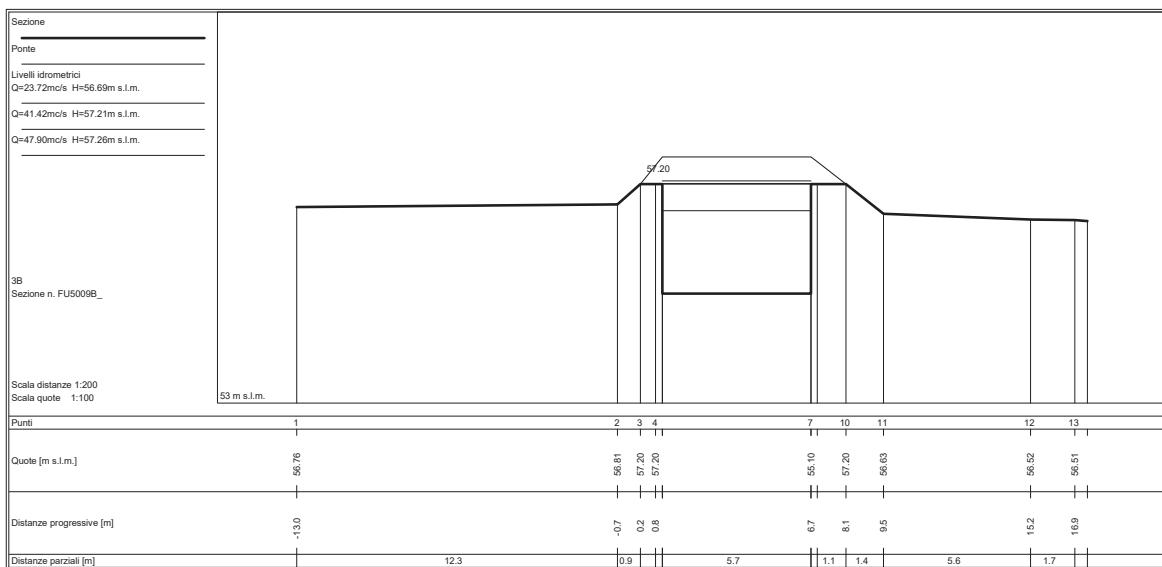
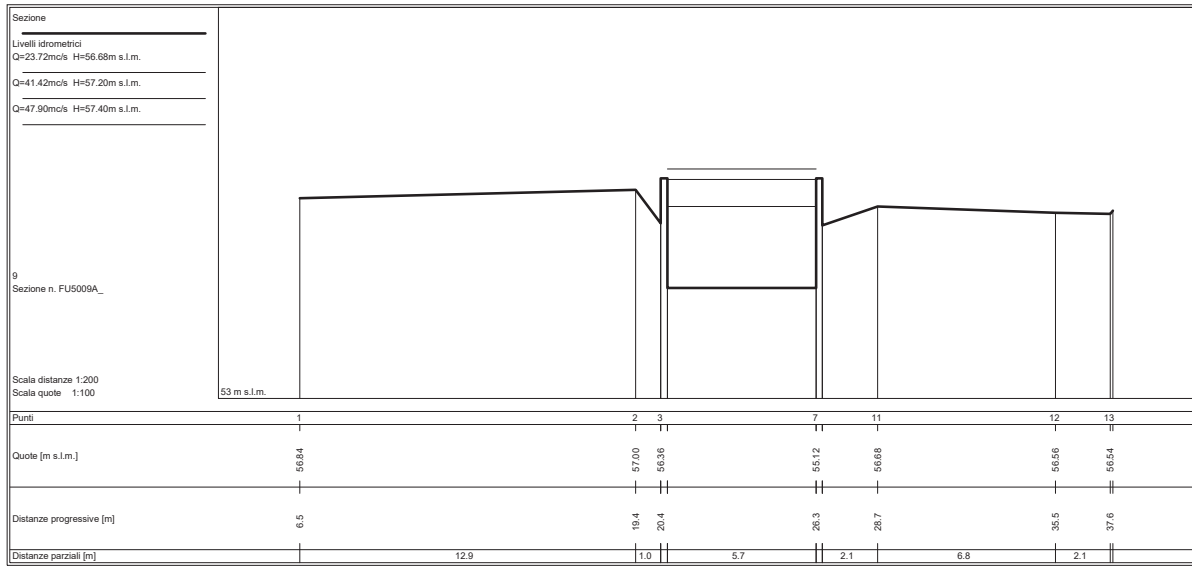

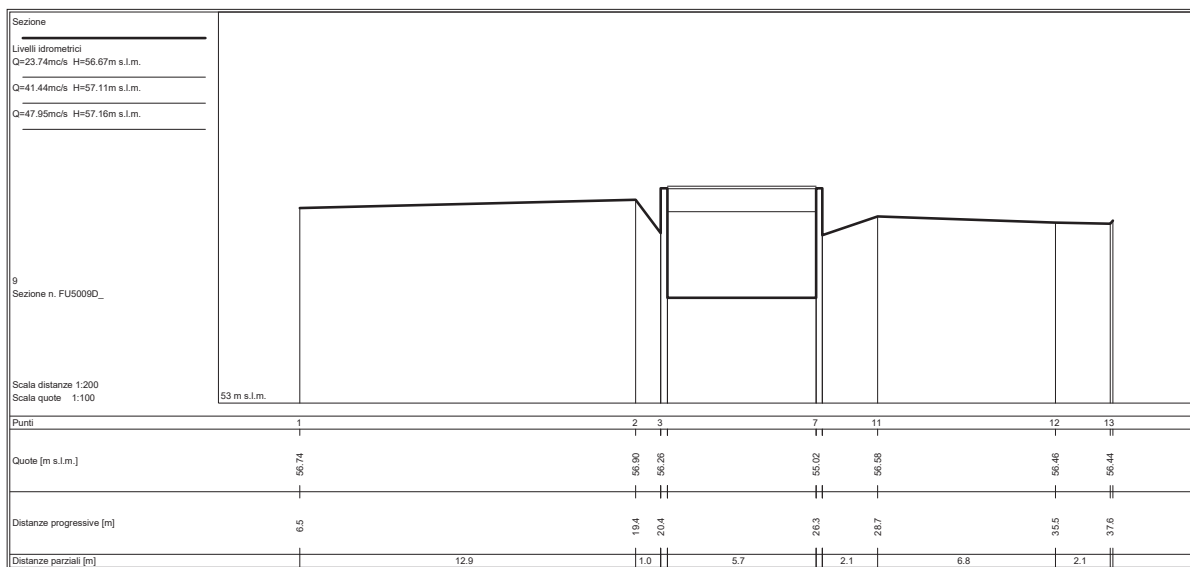
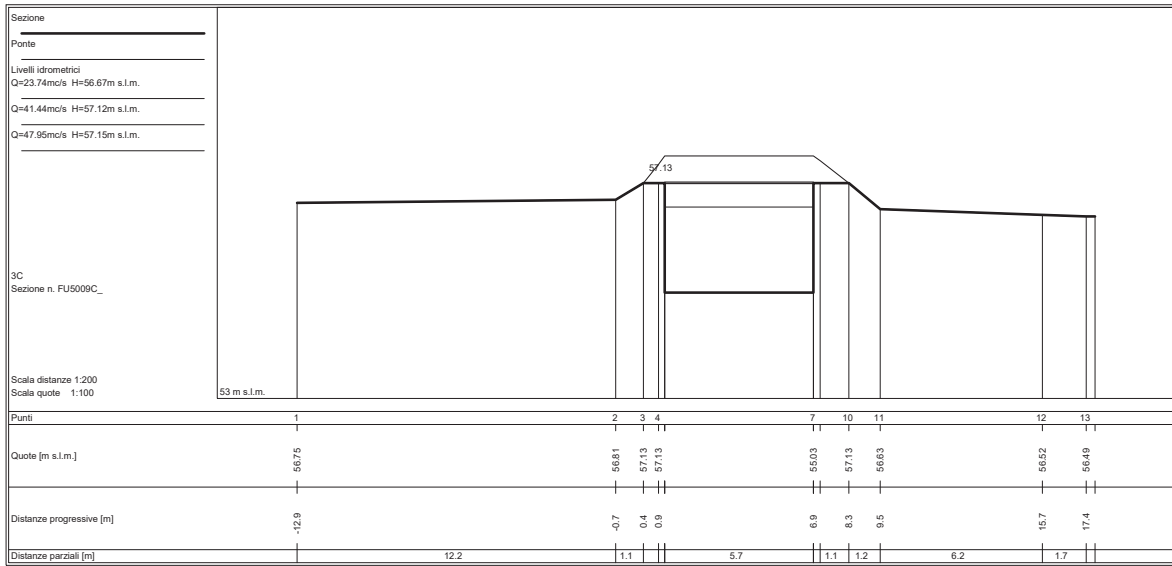

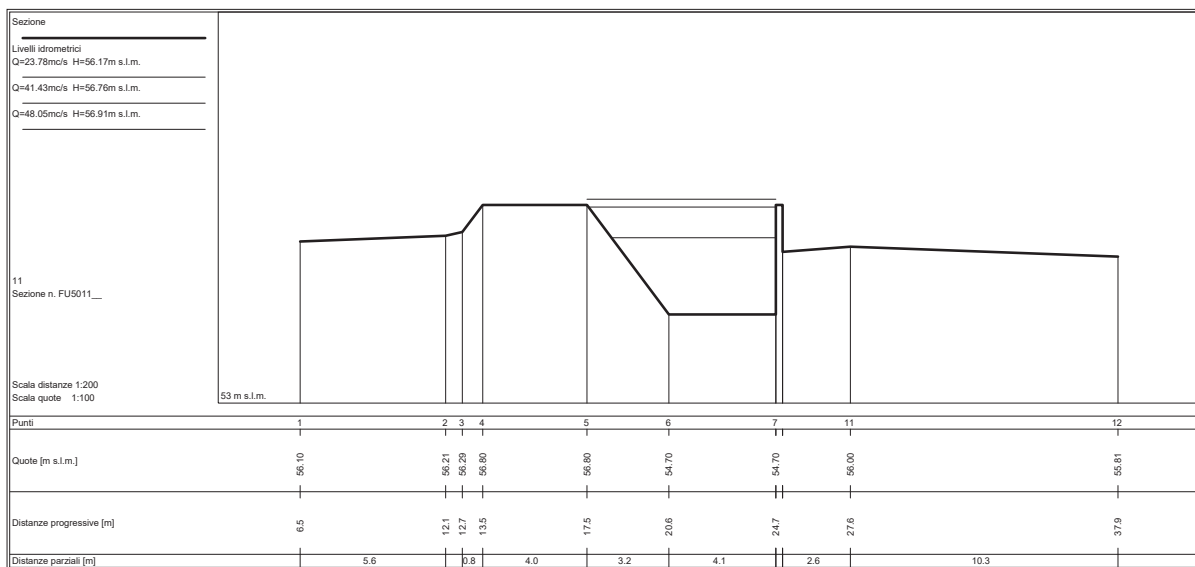
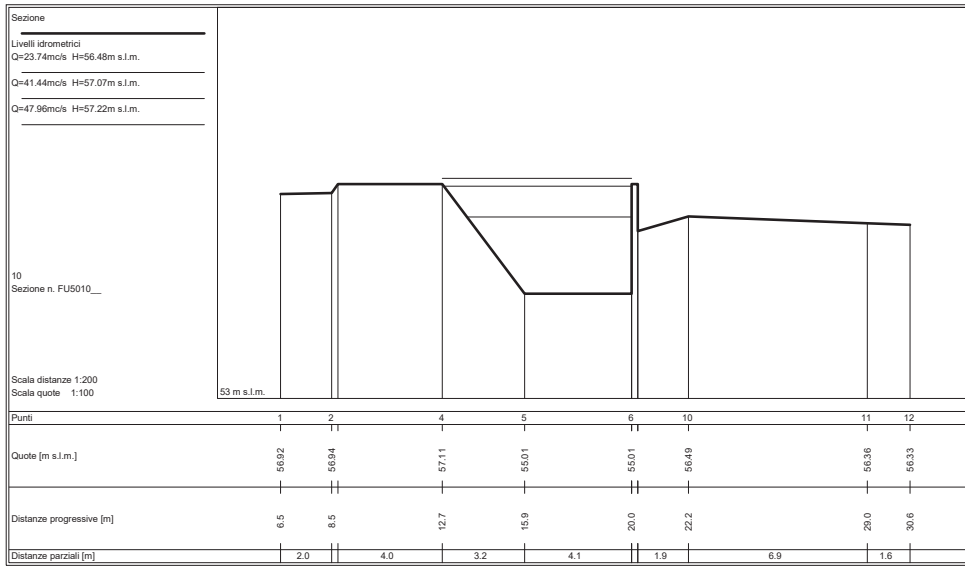

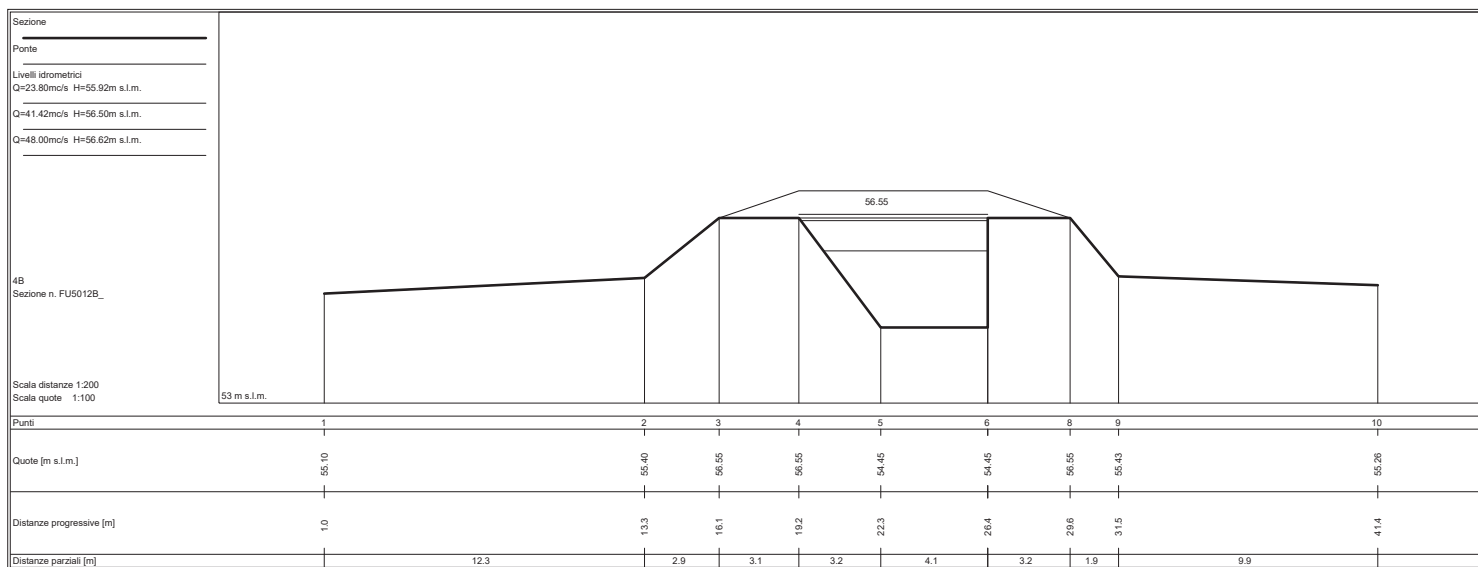
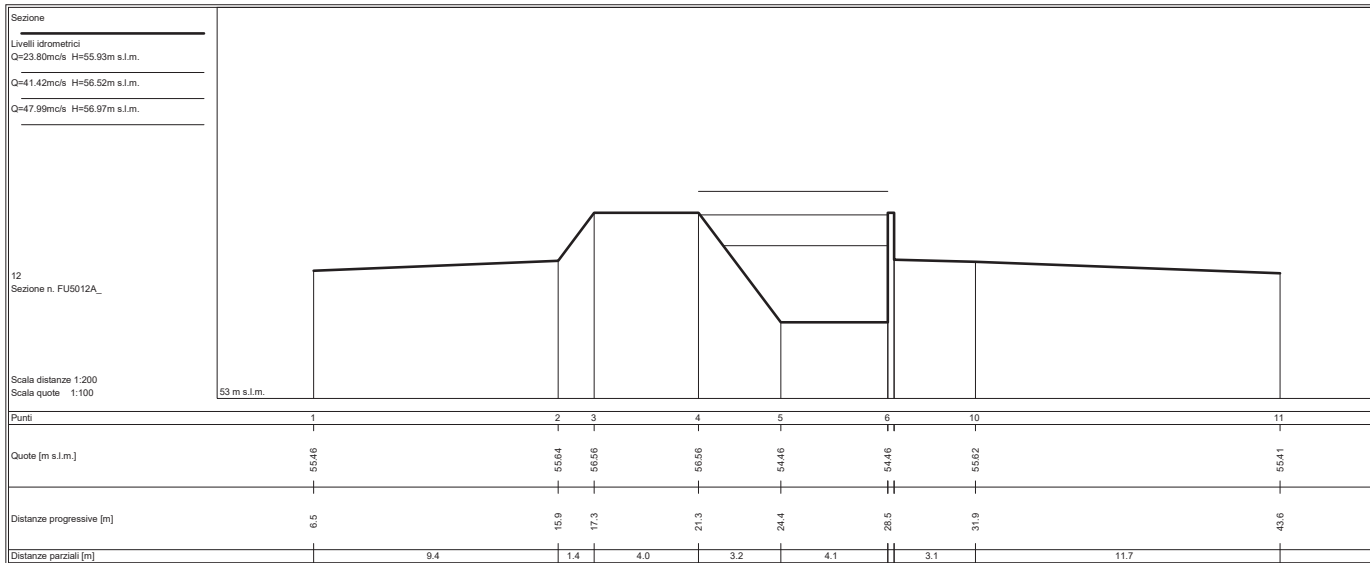

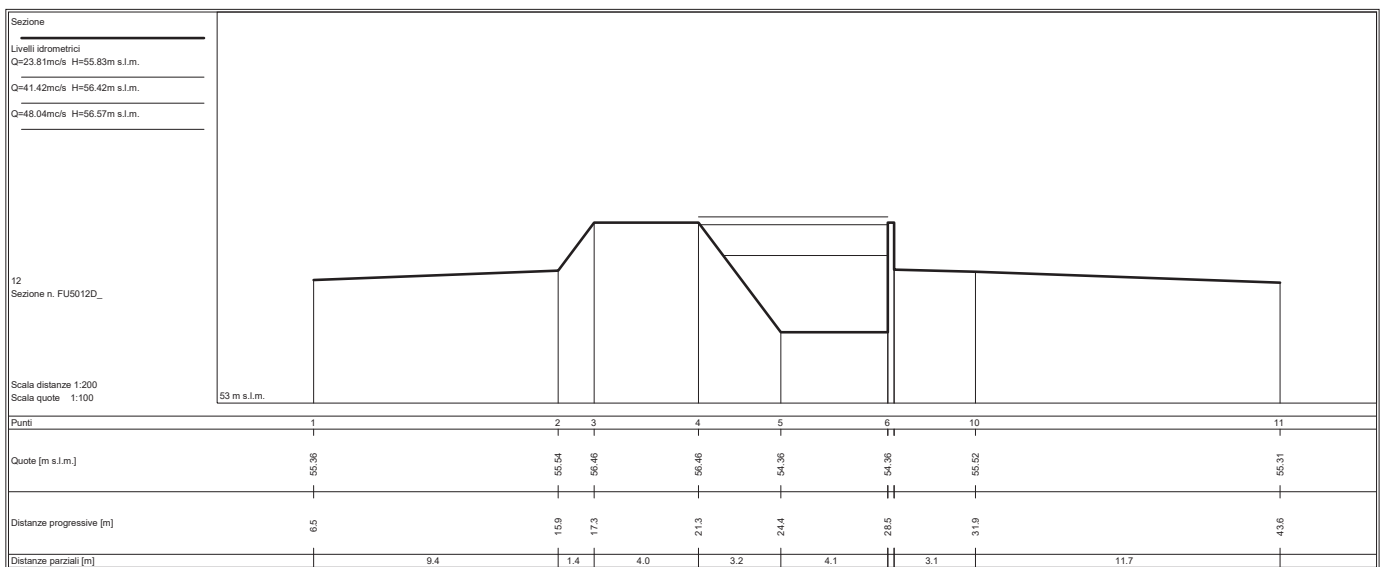
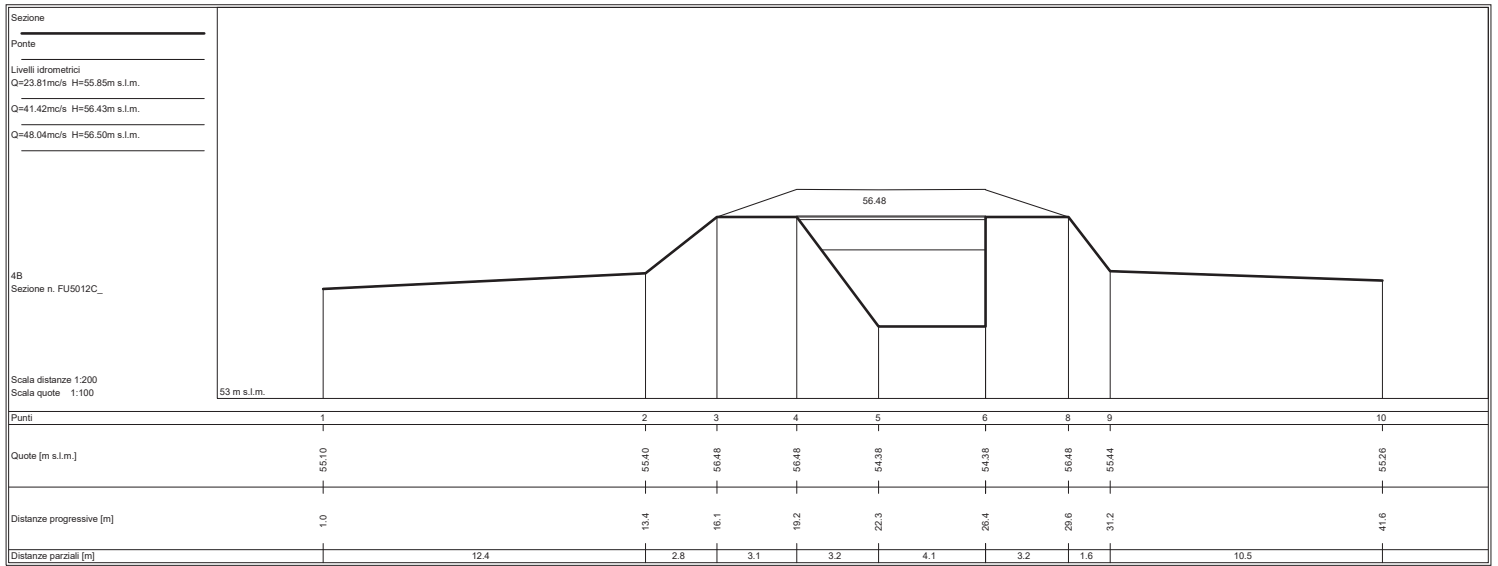



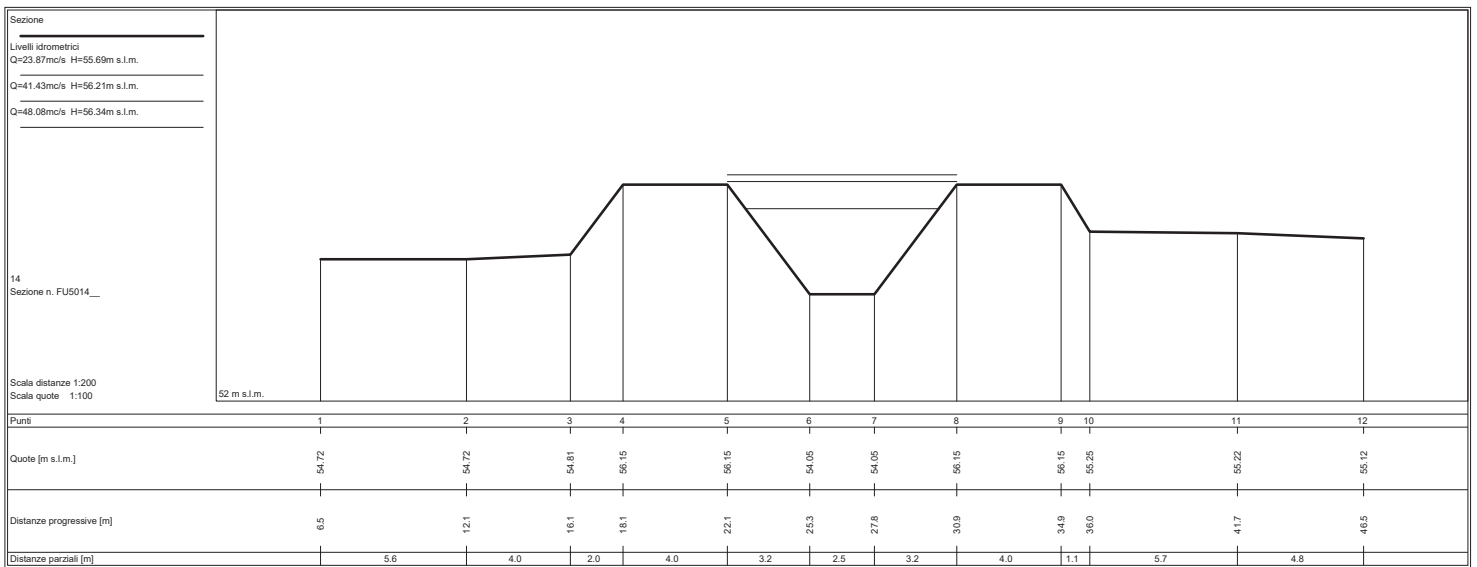
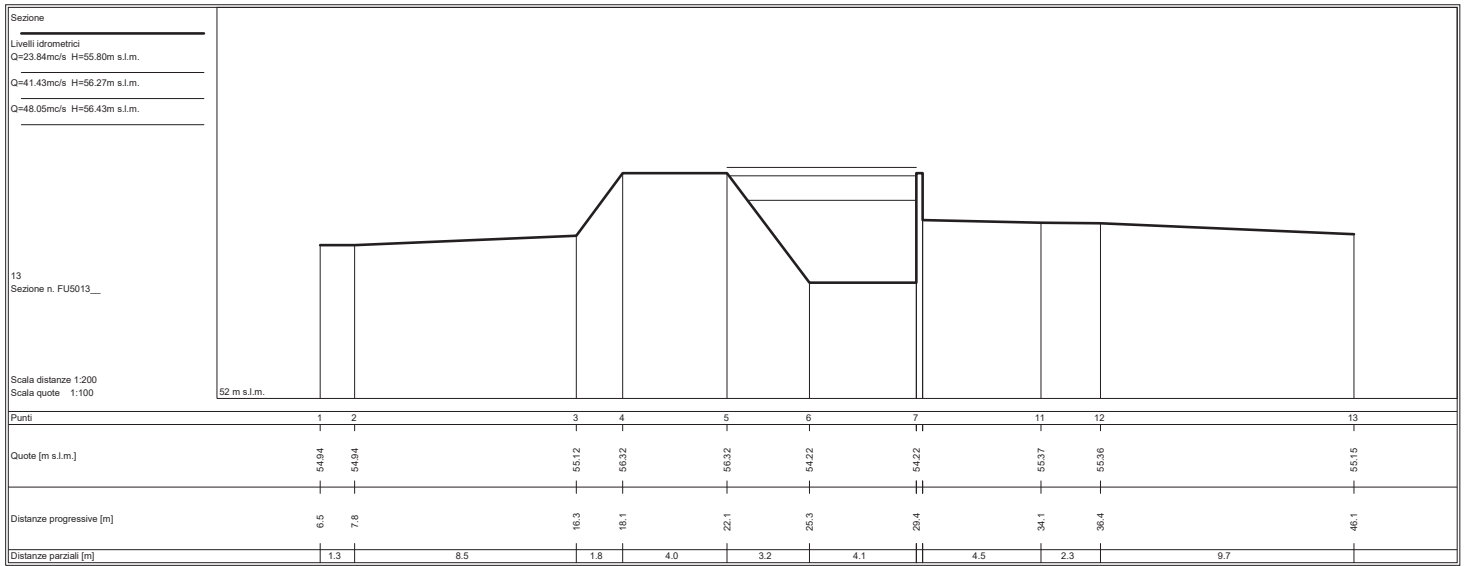

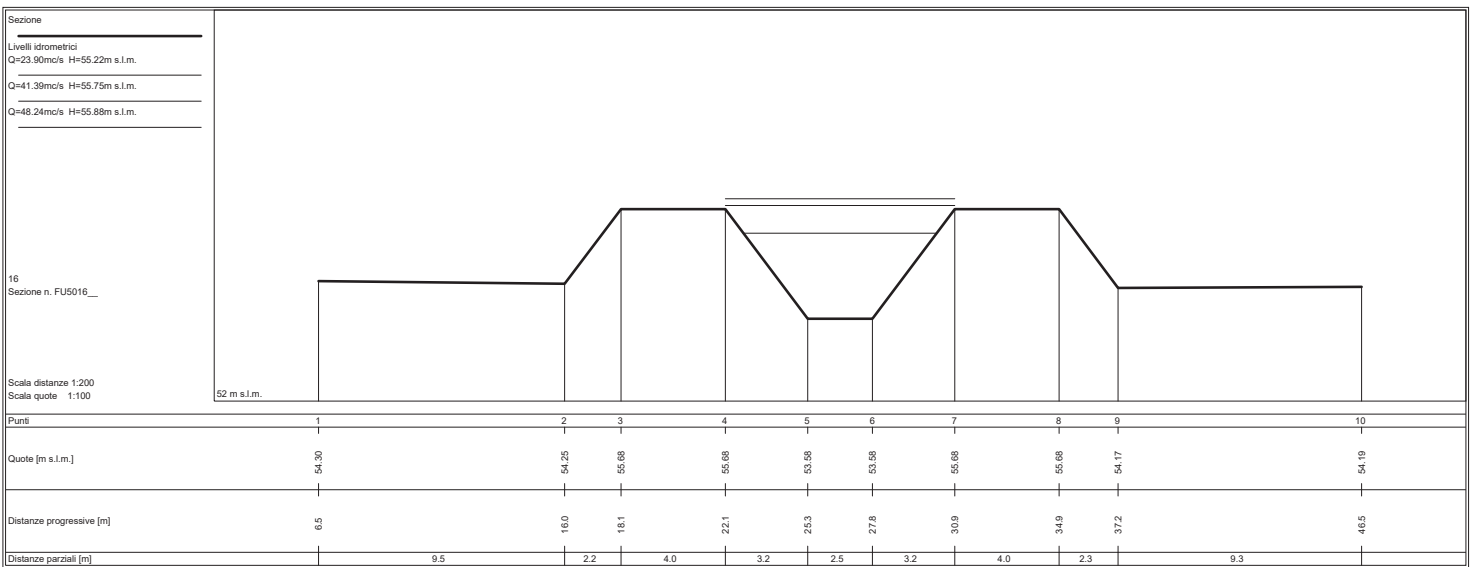
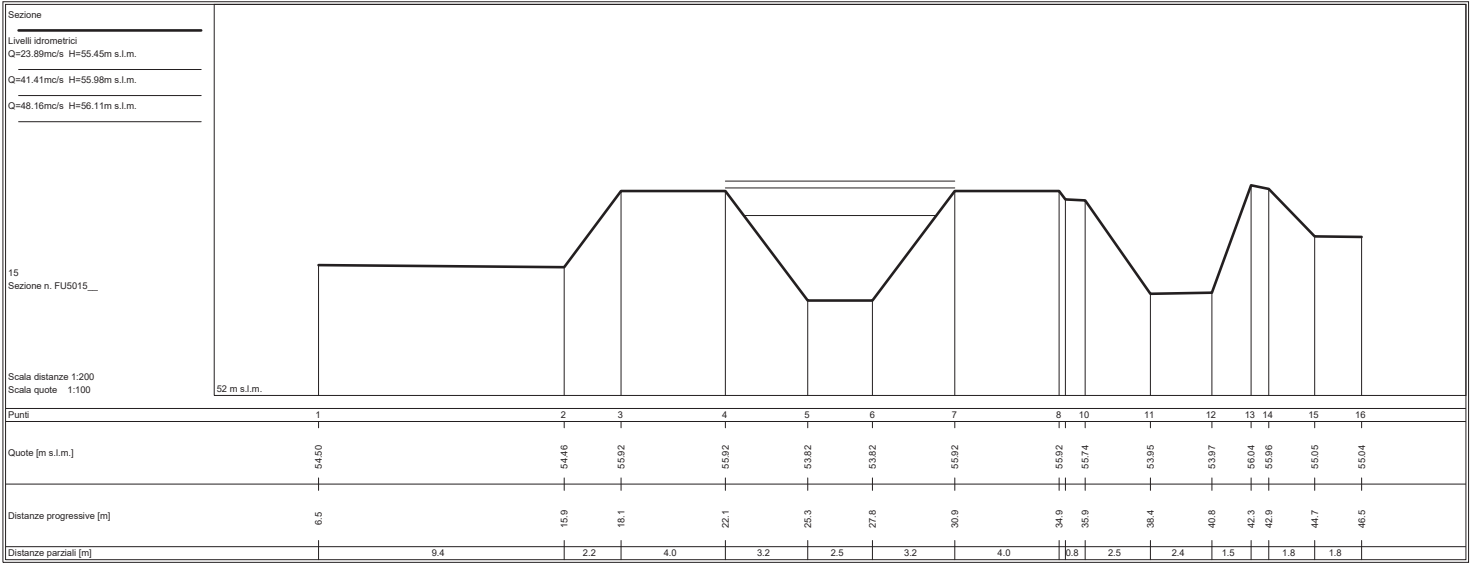

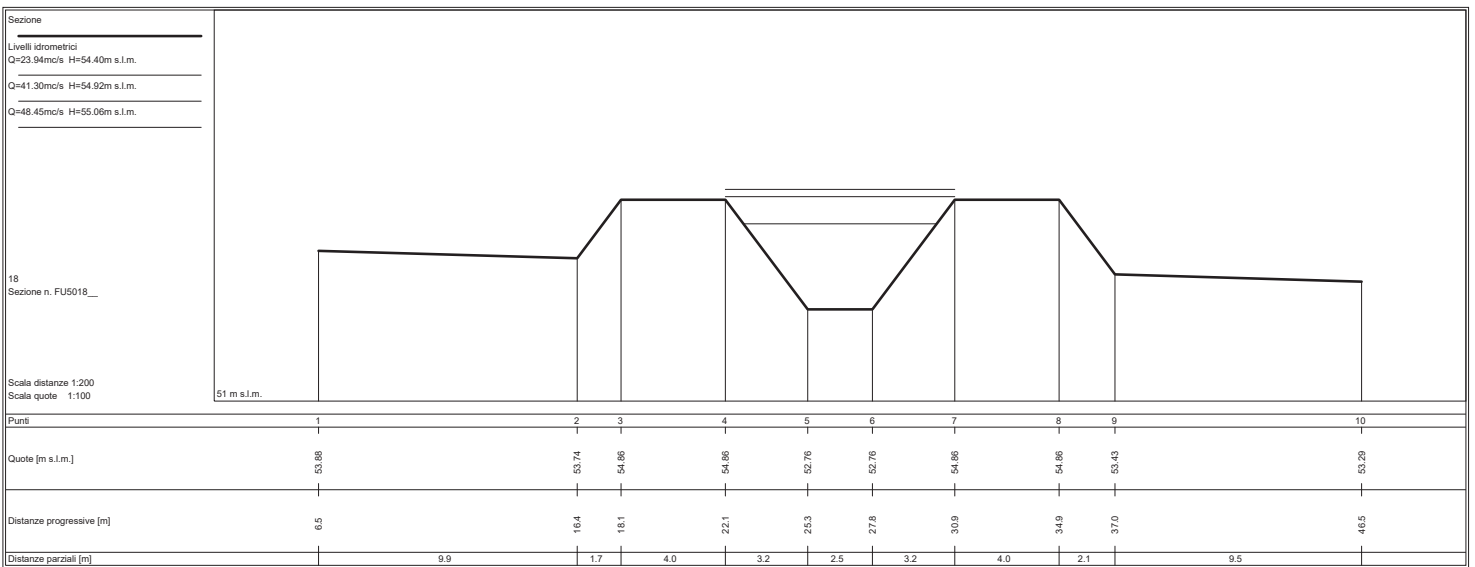
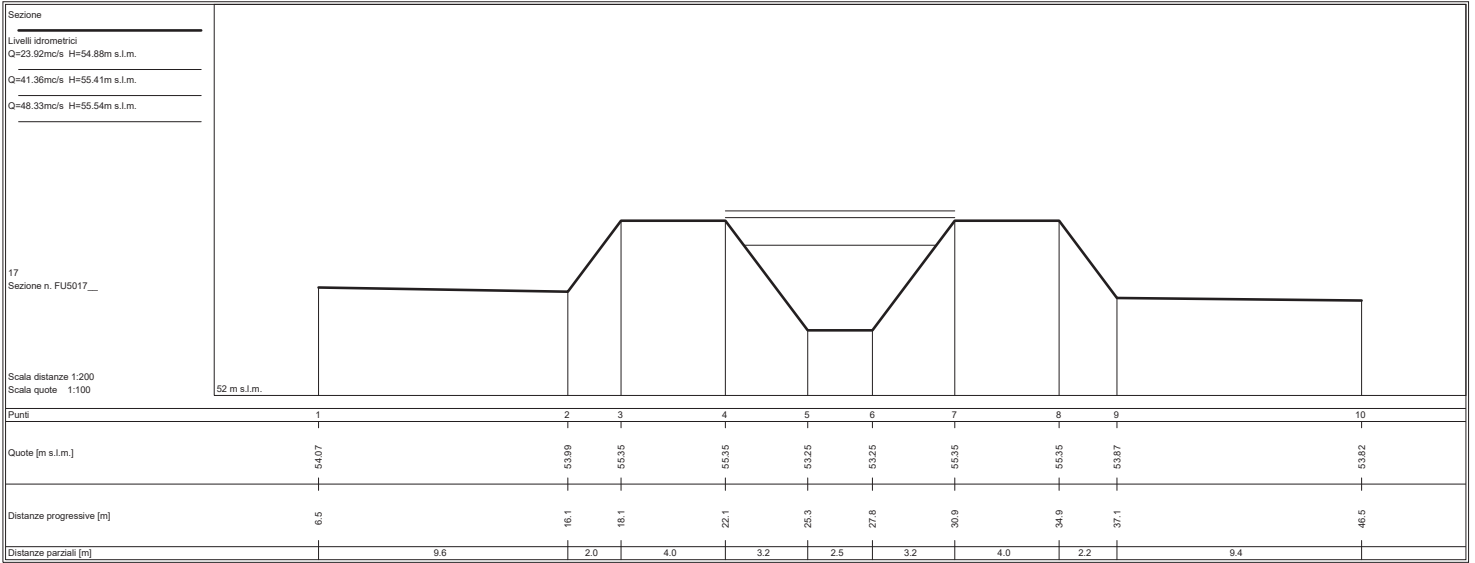

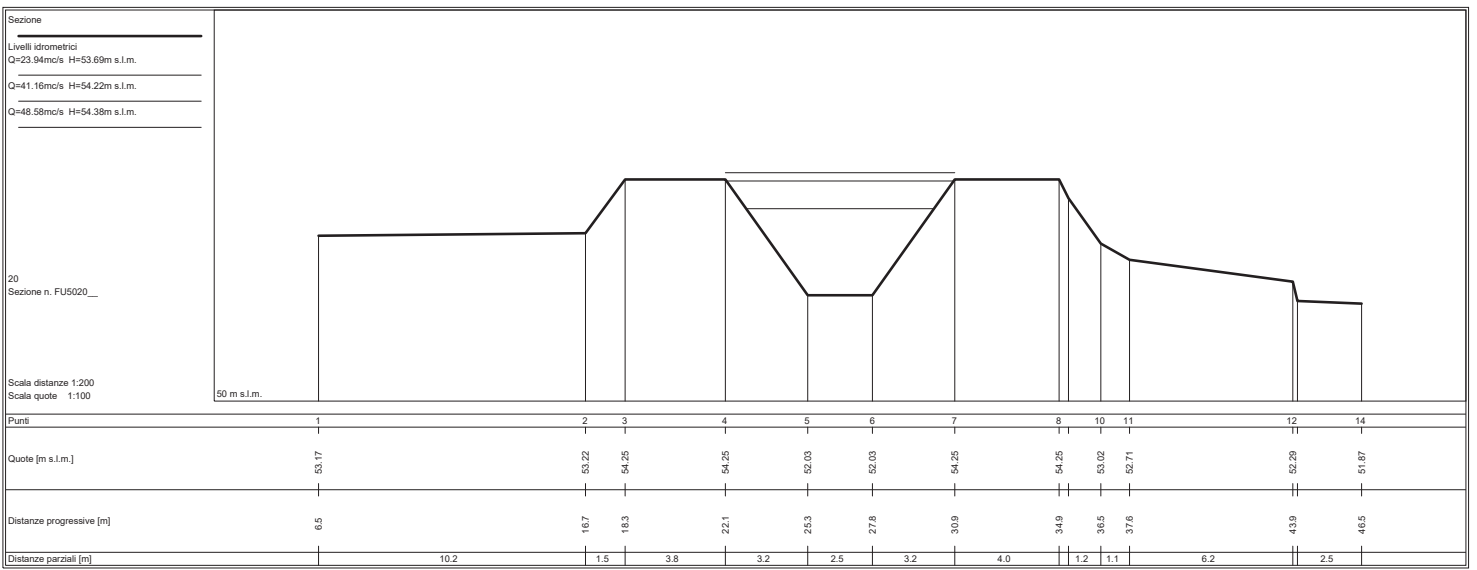
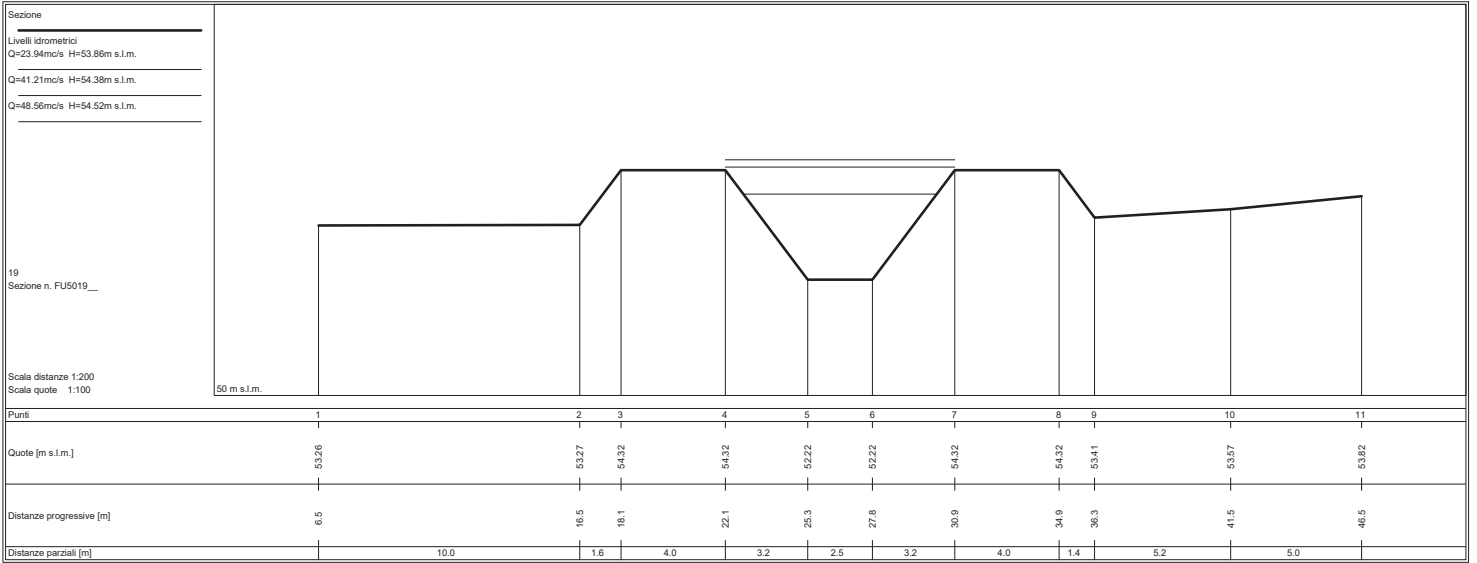

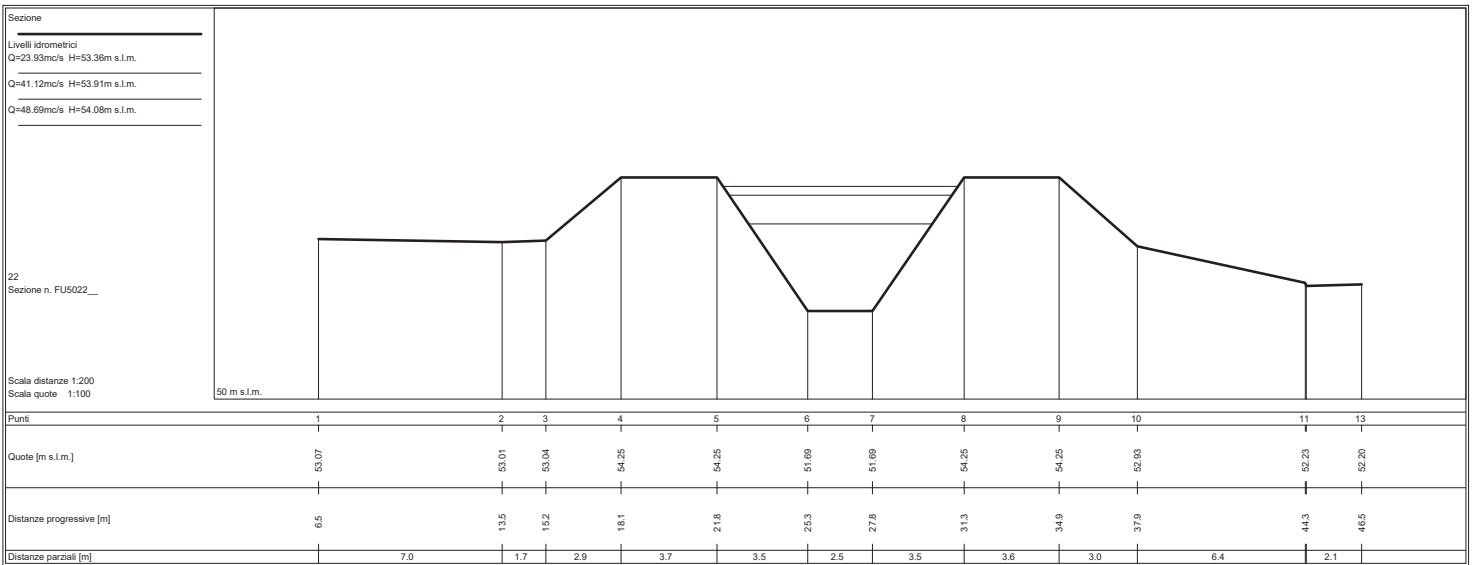
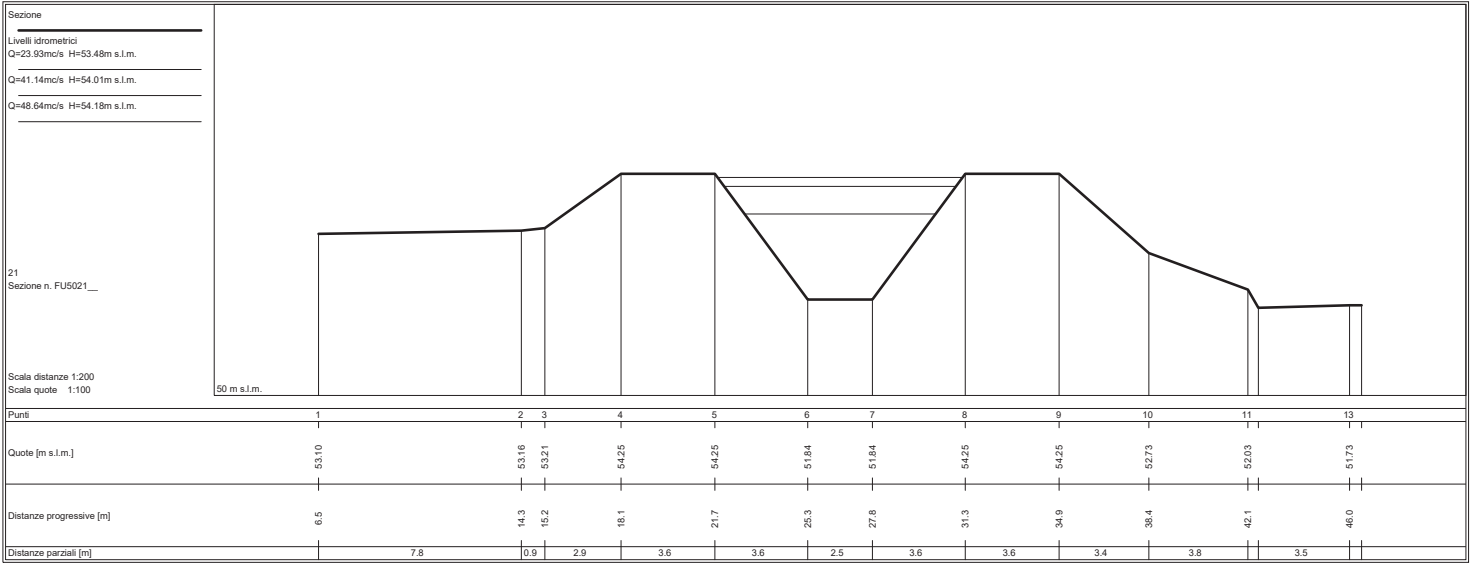

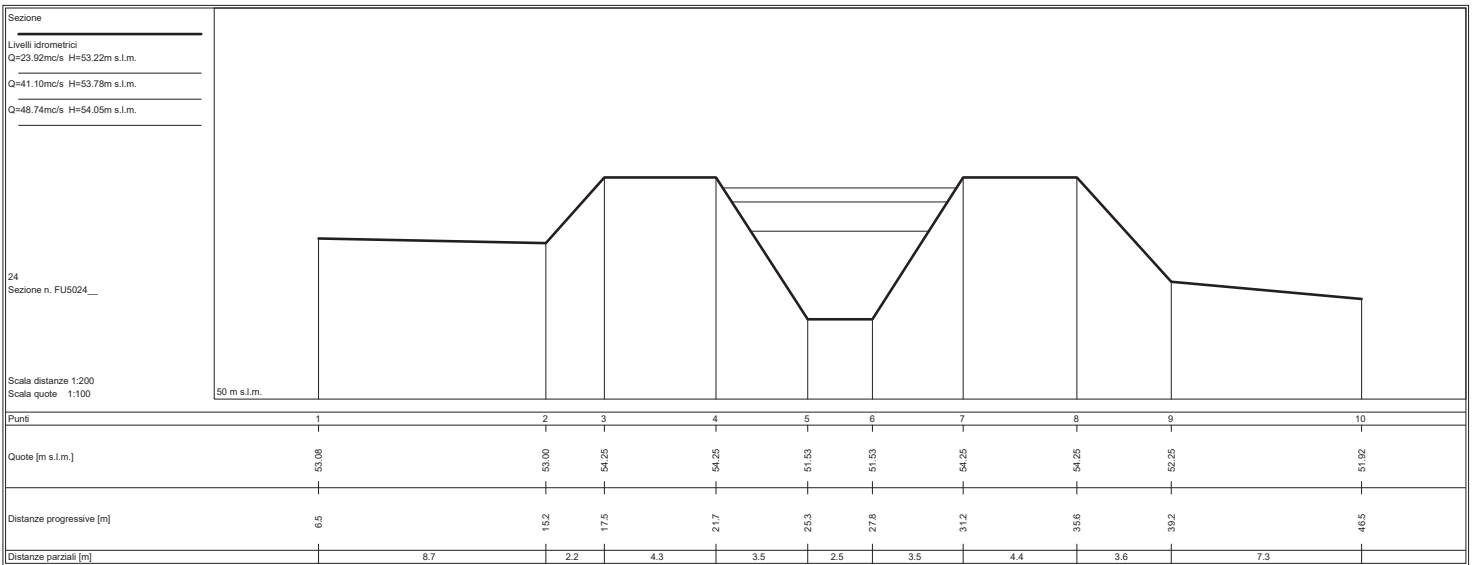
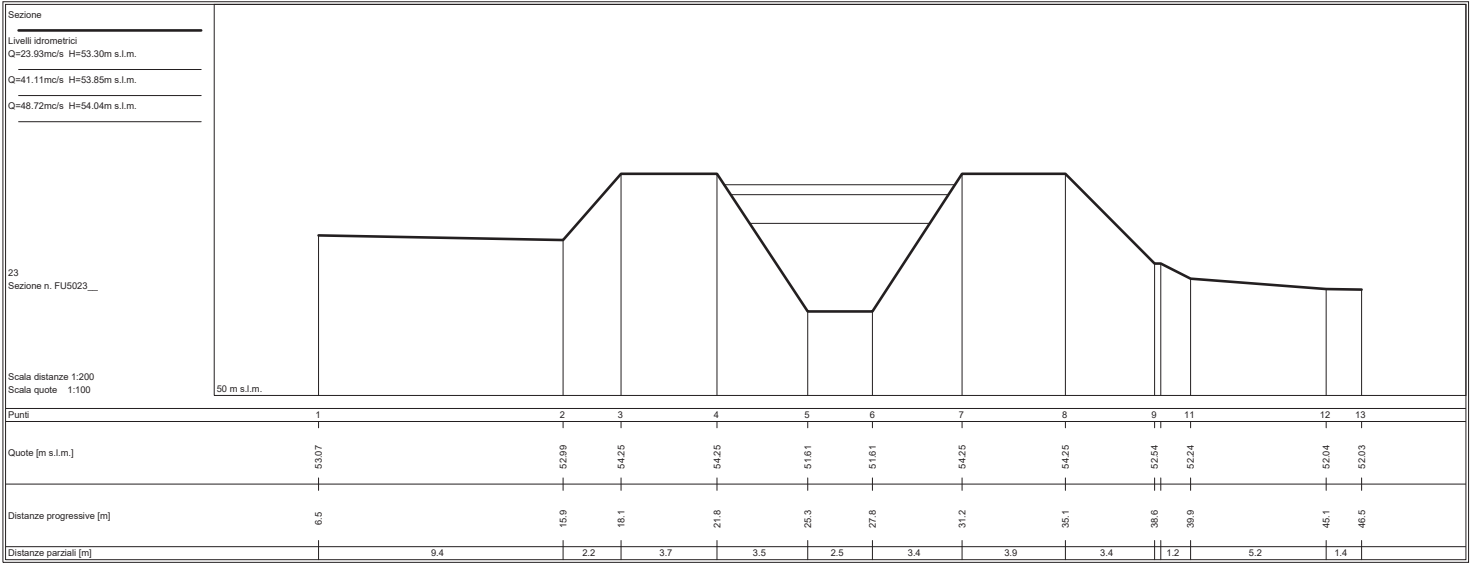

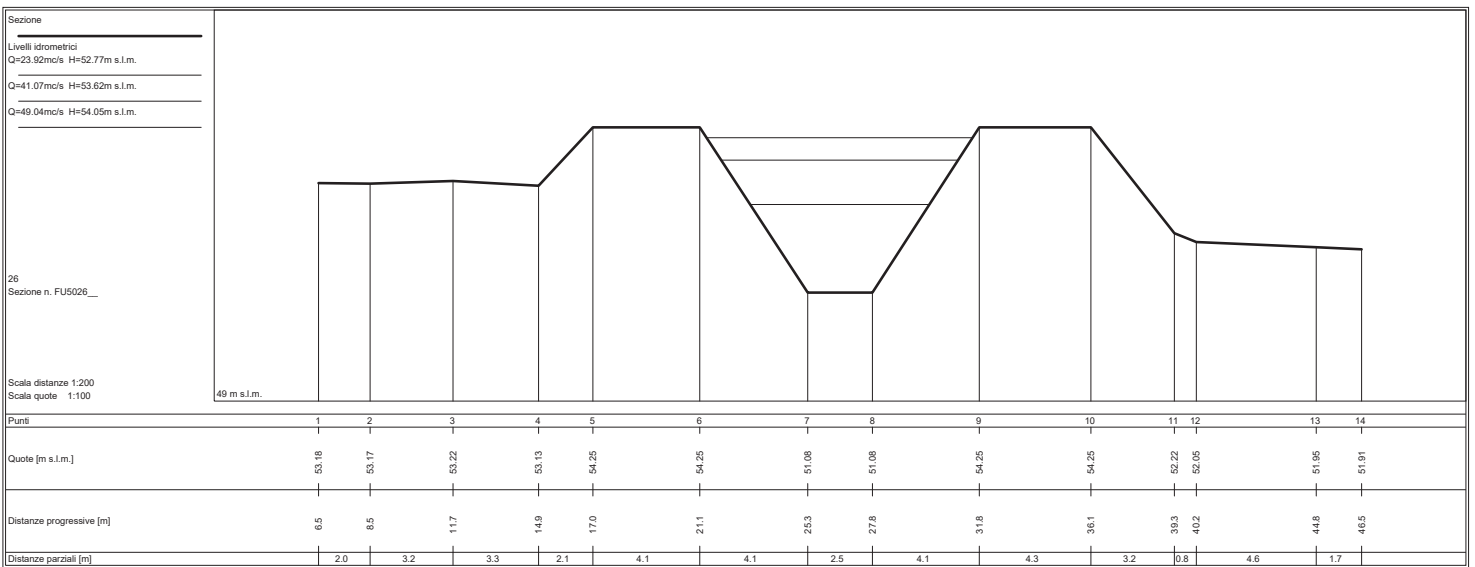
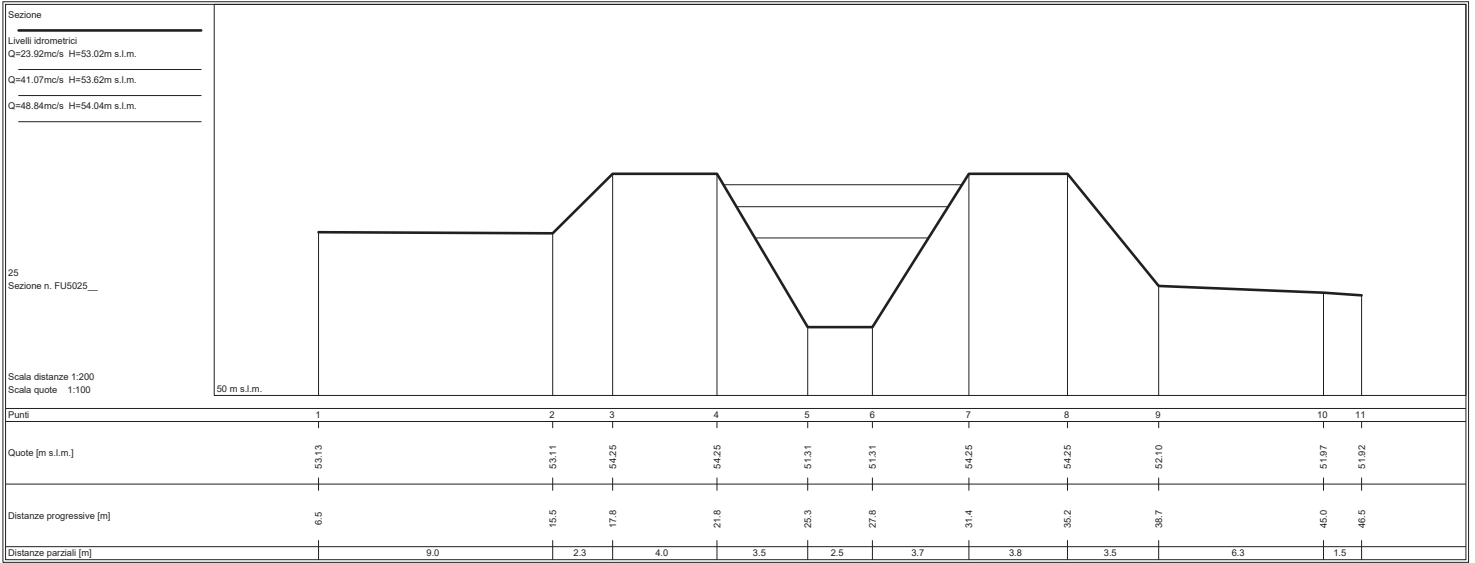

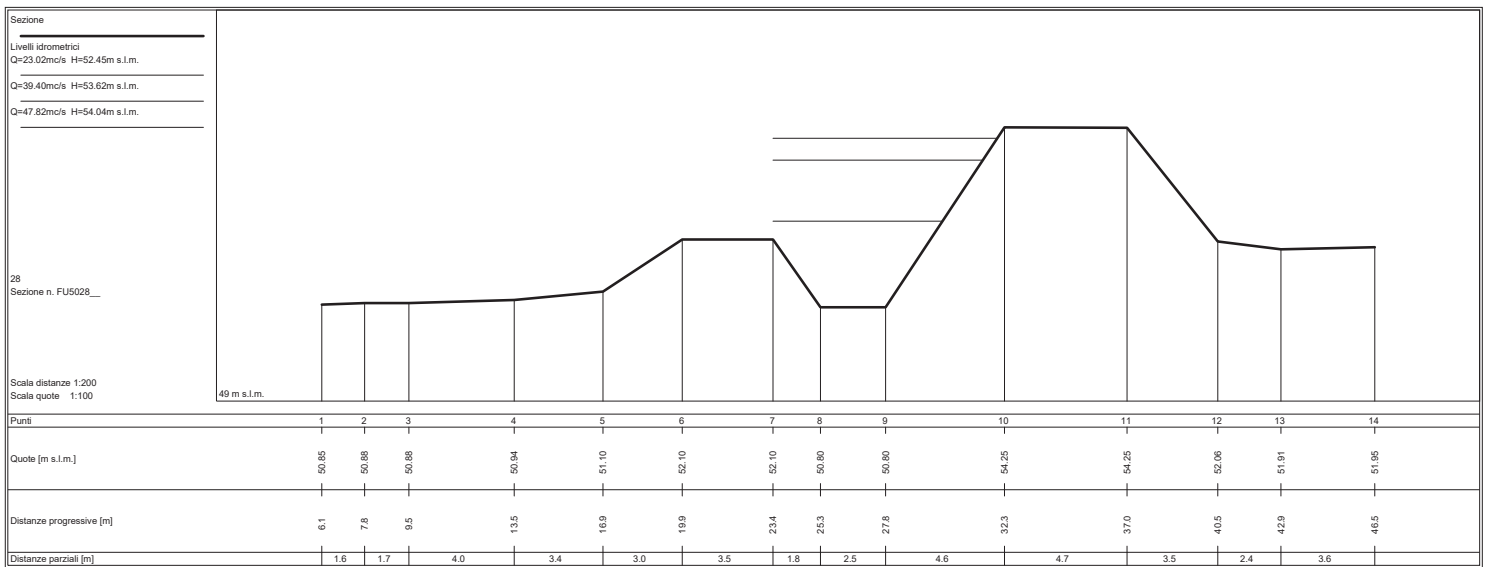
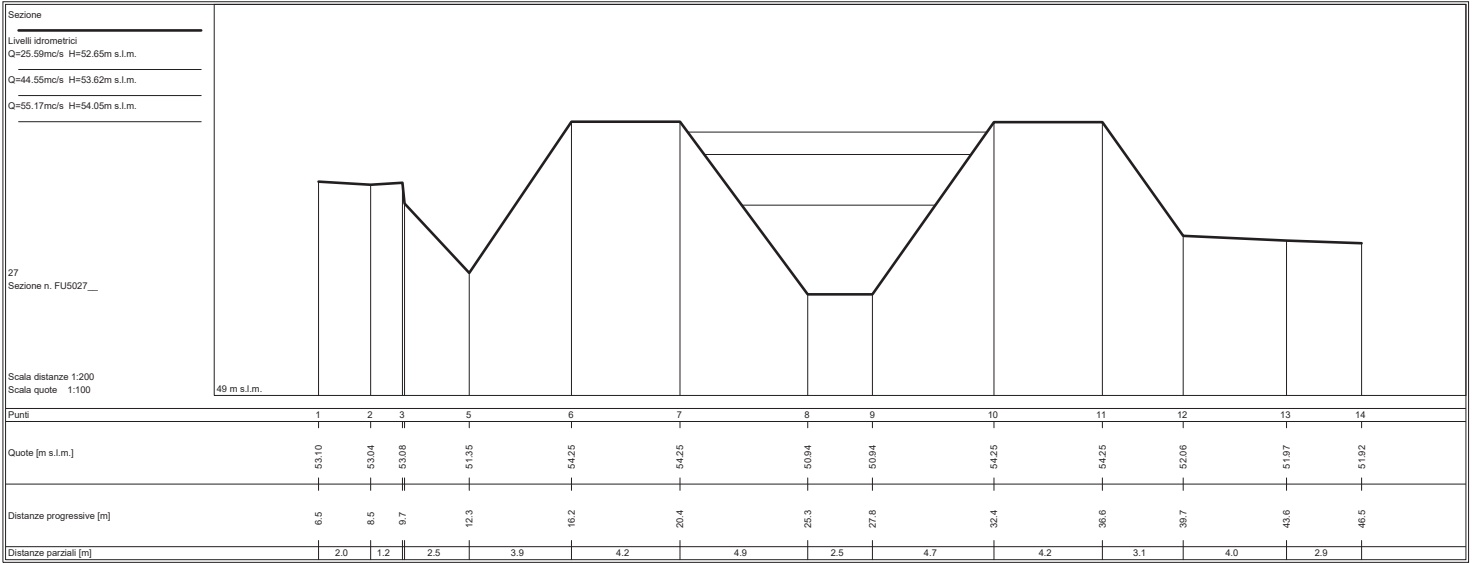



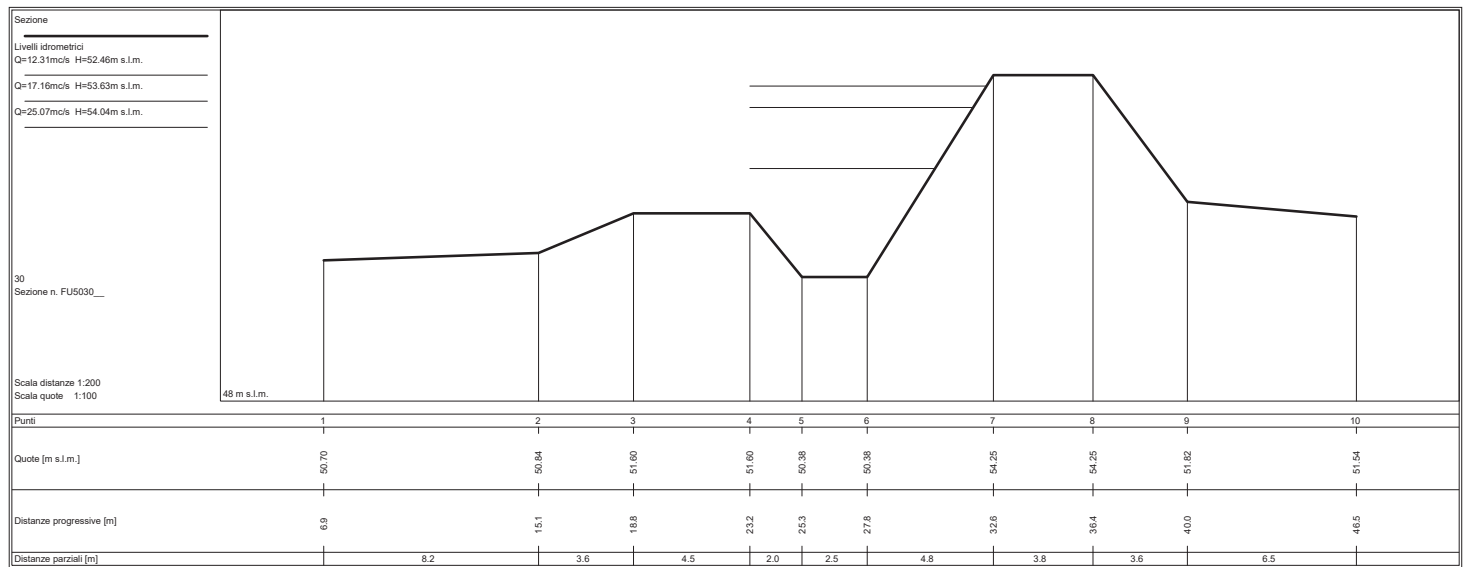
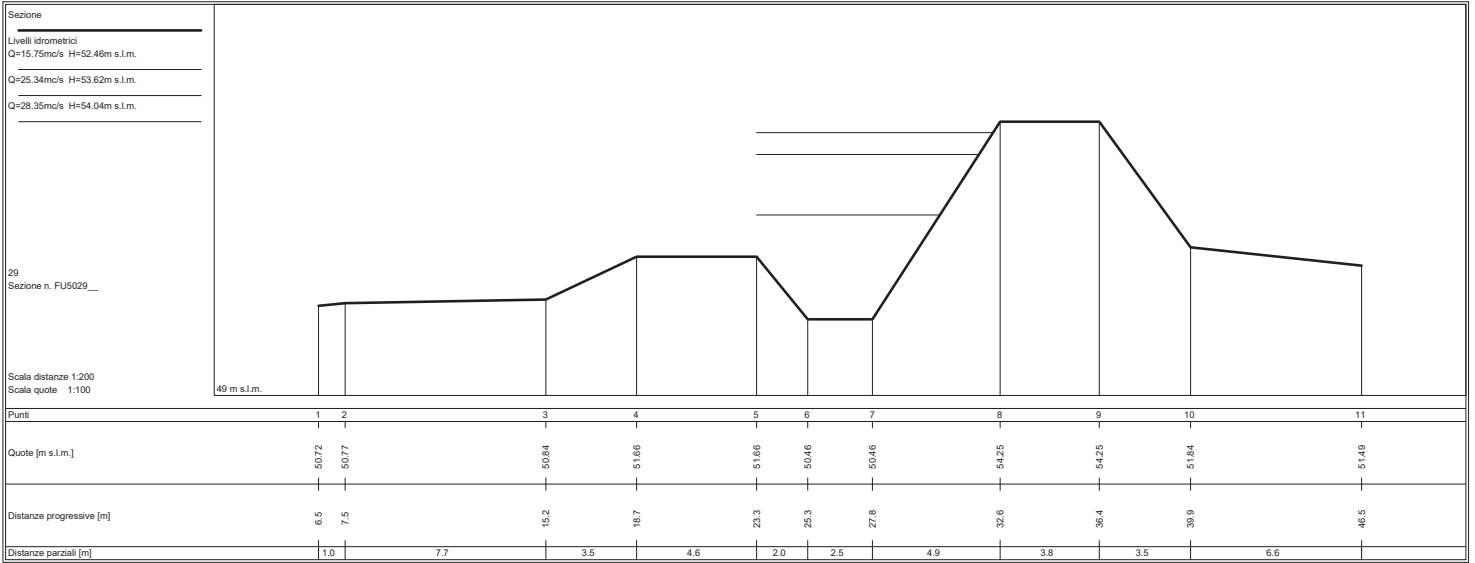

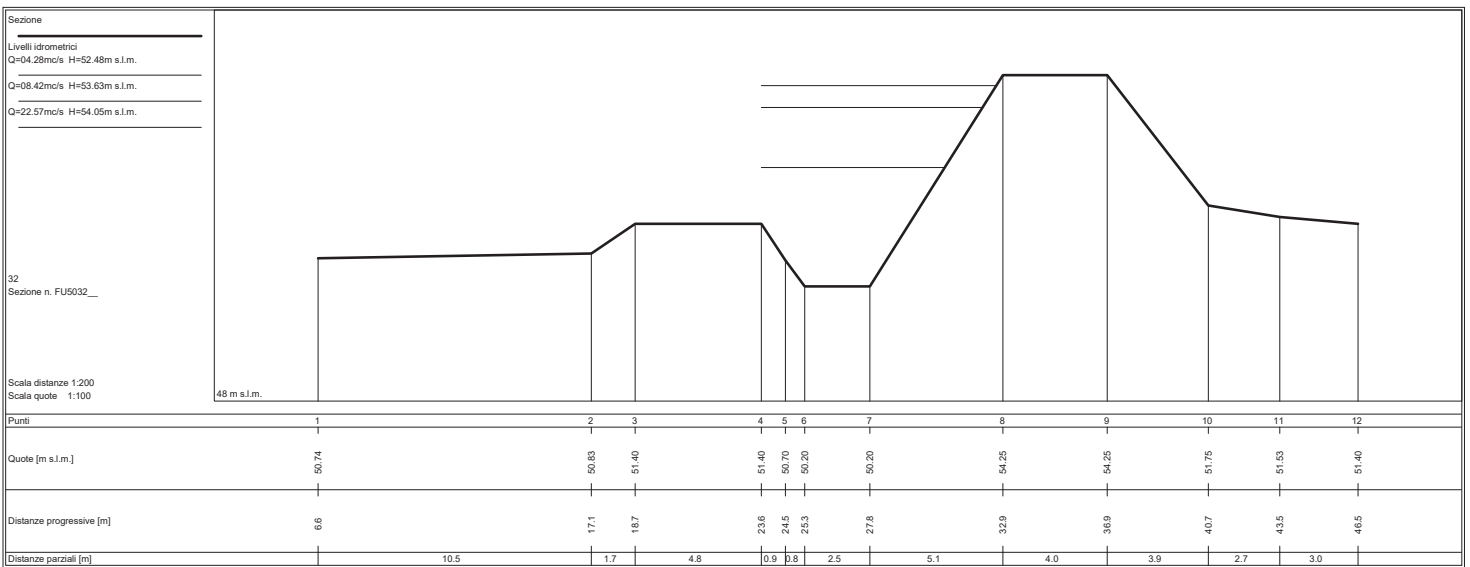
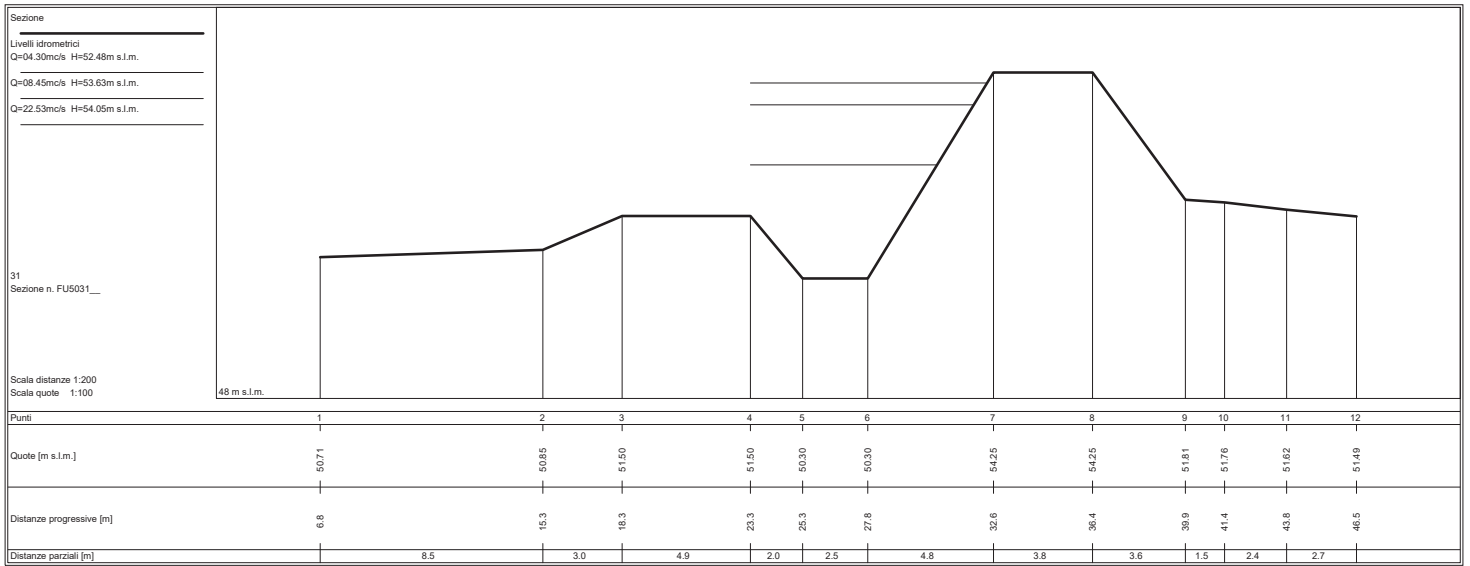

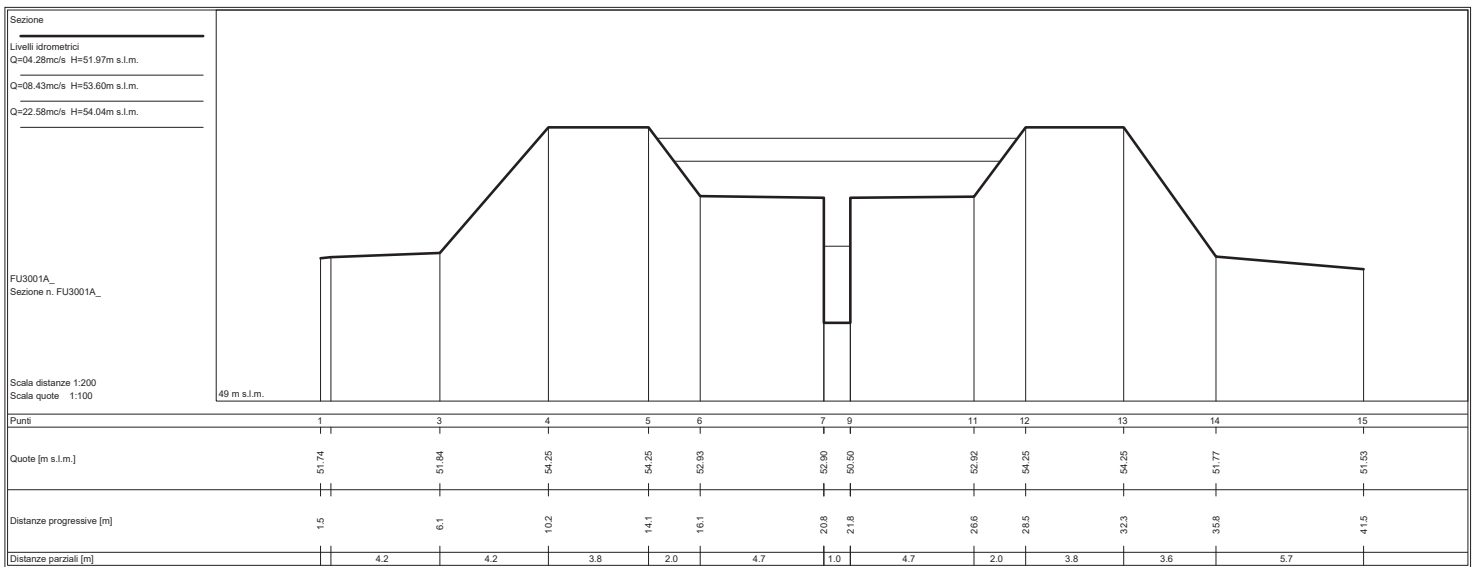
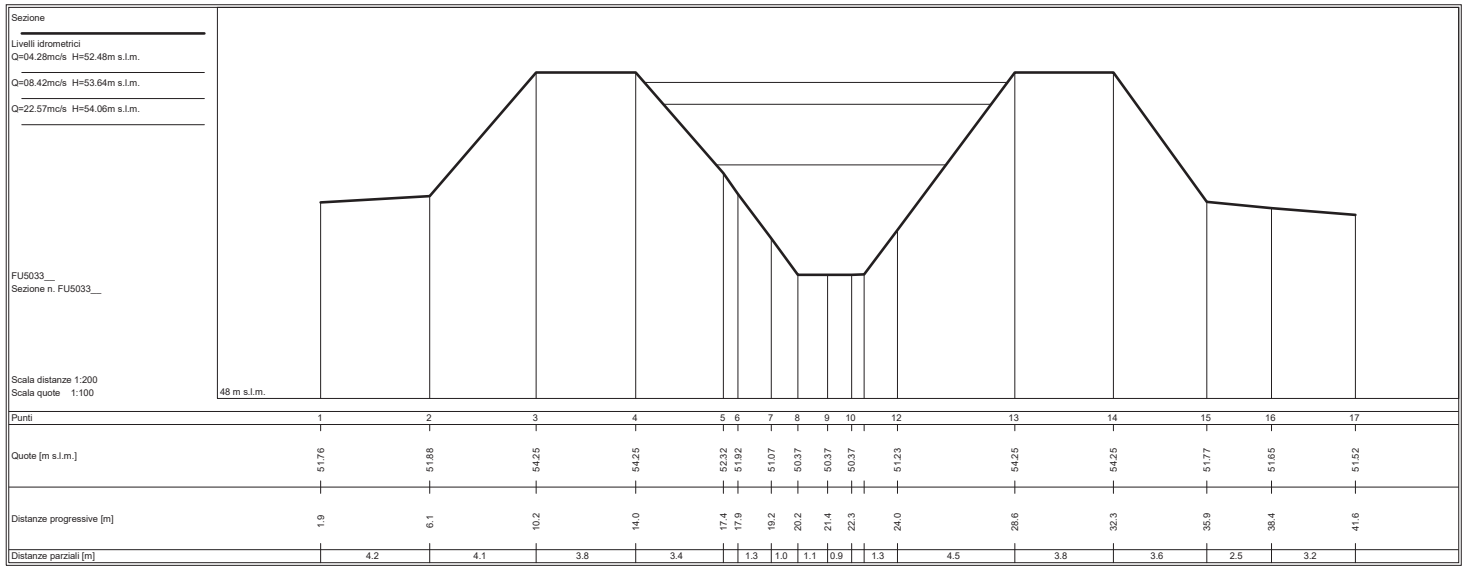

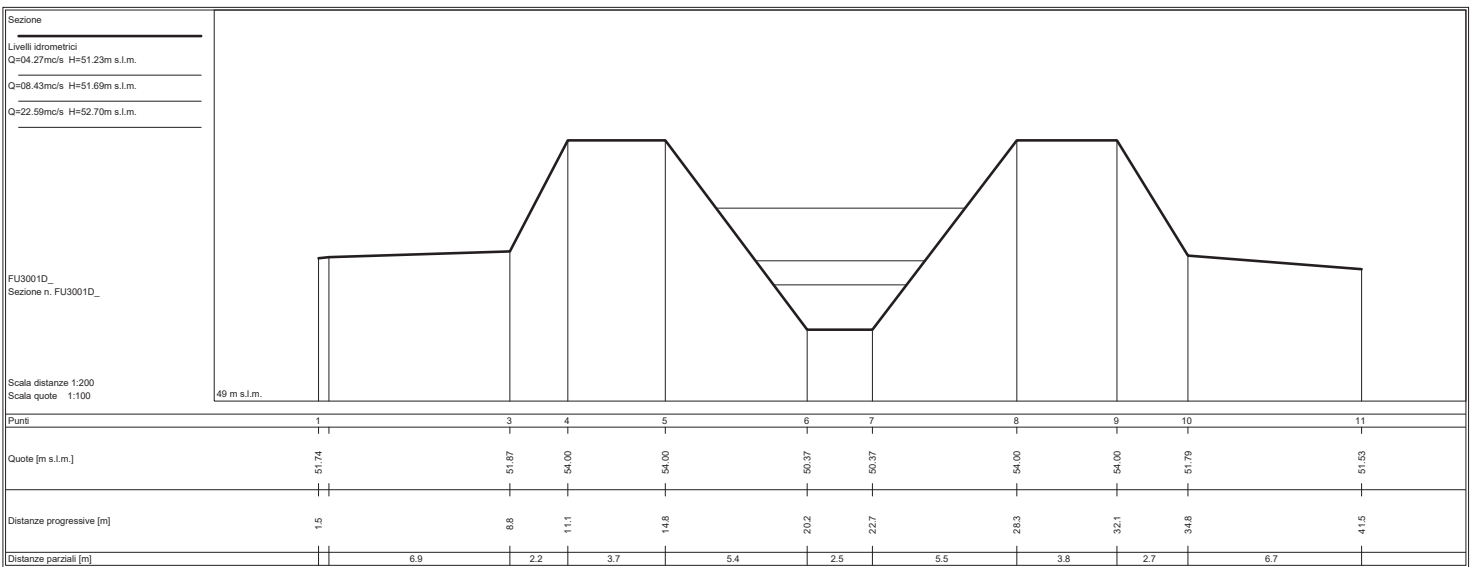
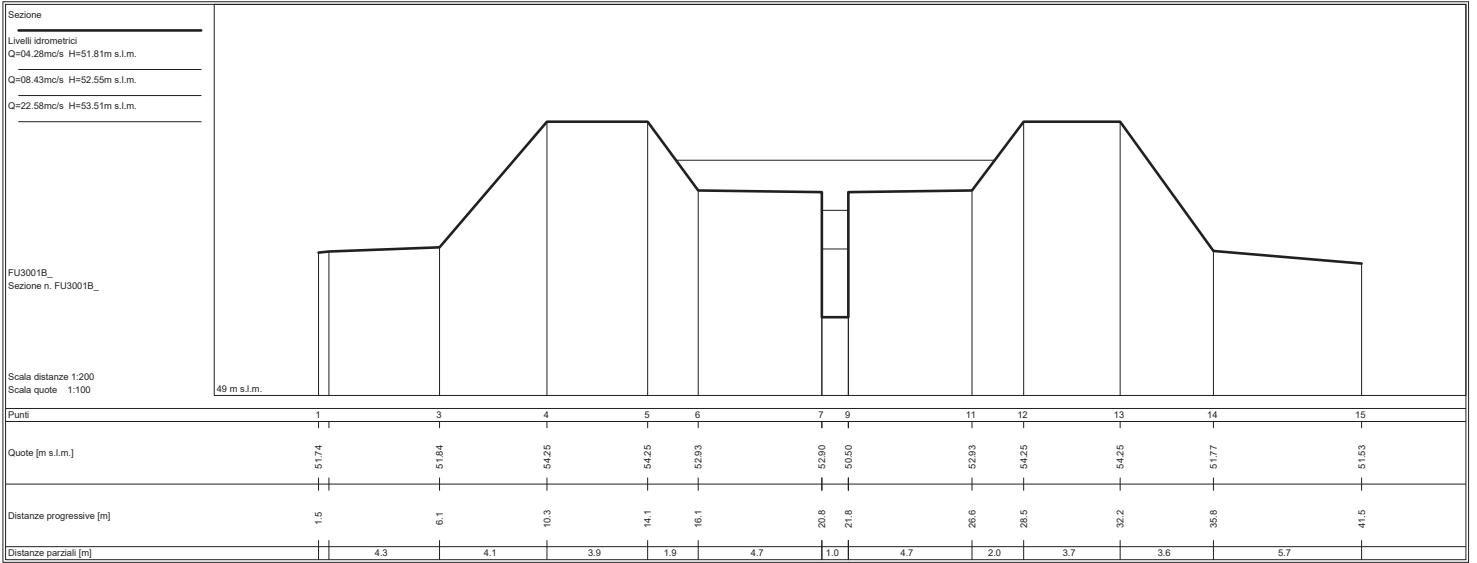

SEZIONI FLUVIALI  
FOSSO FUNANDOLA - TRATTO 3

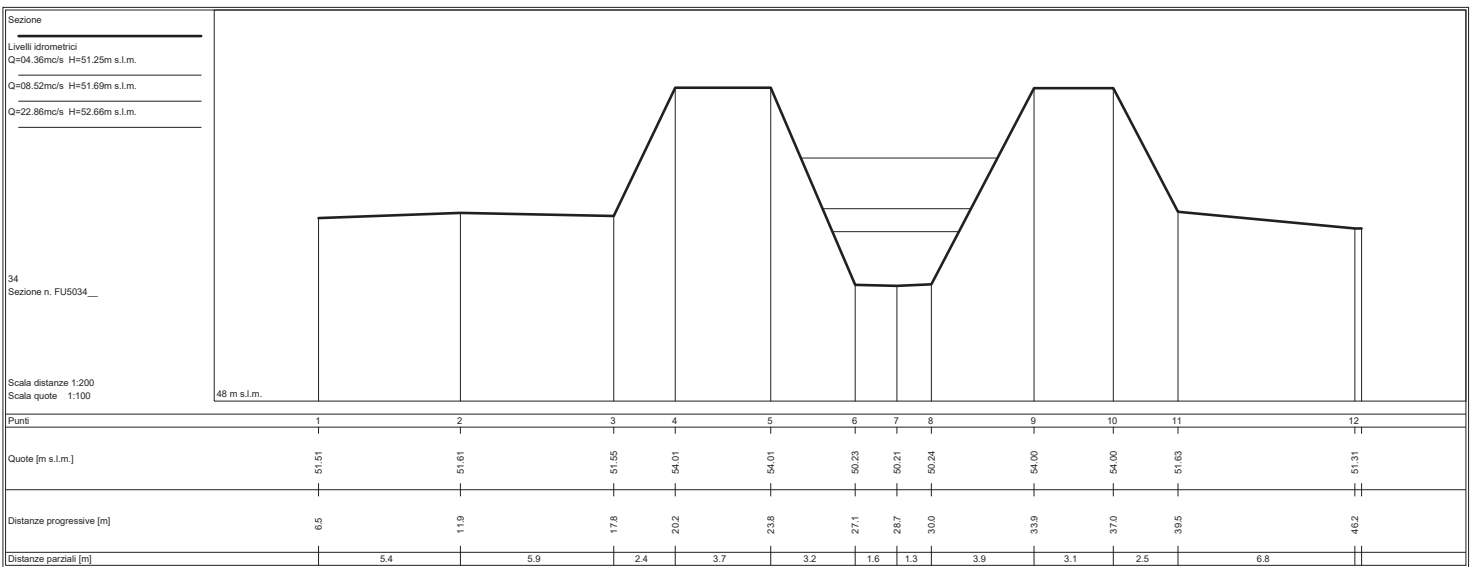
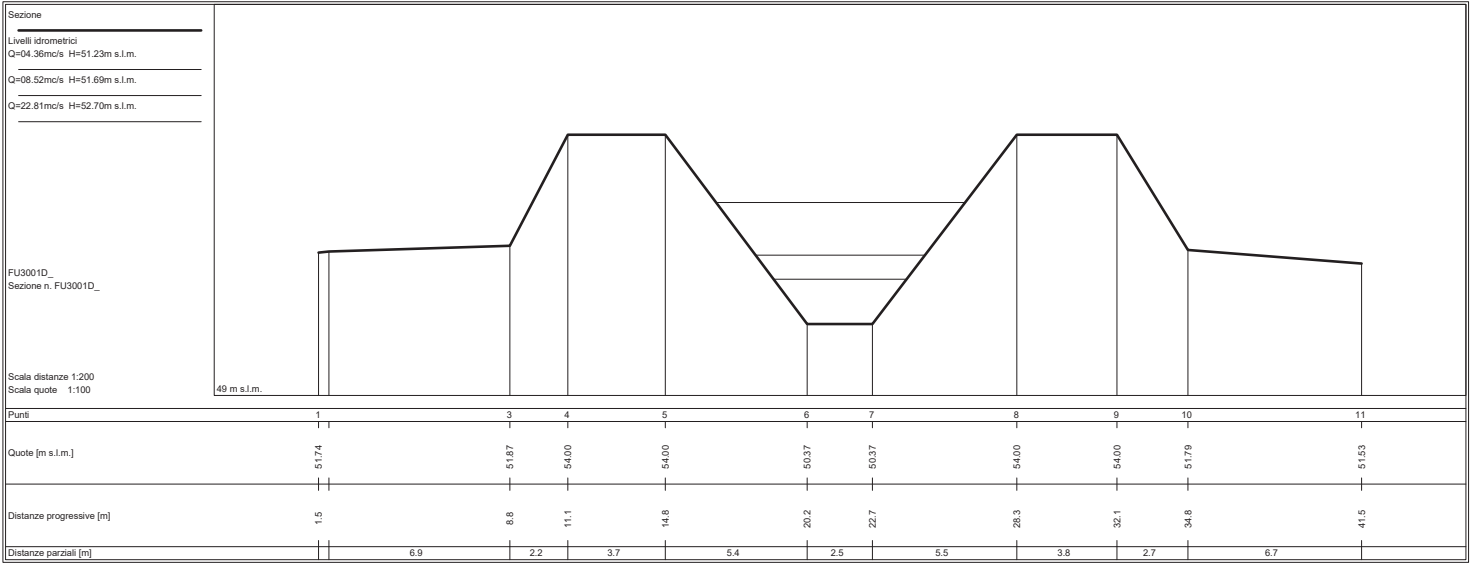

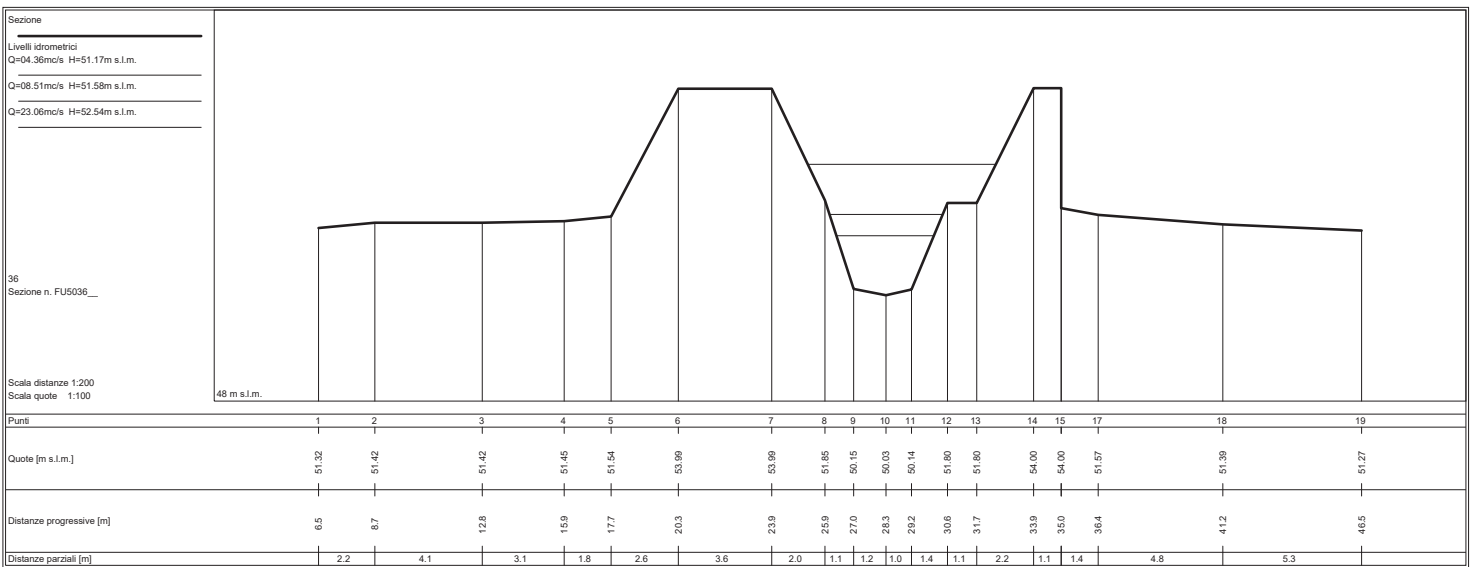
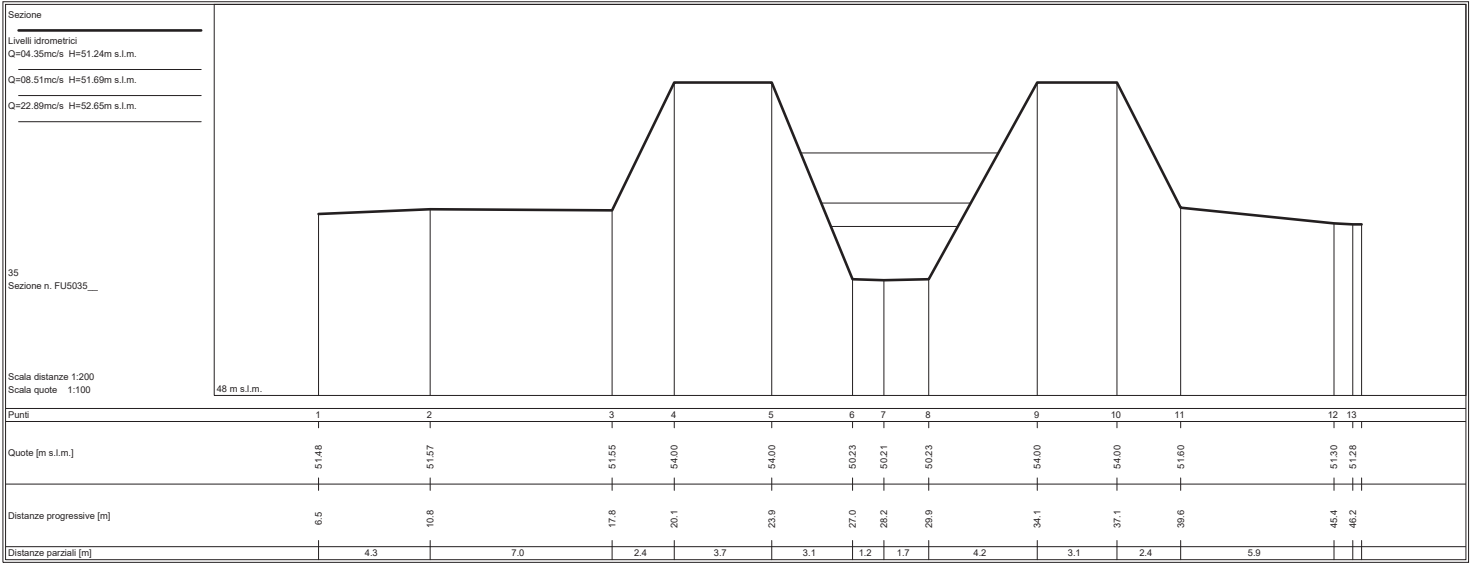

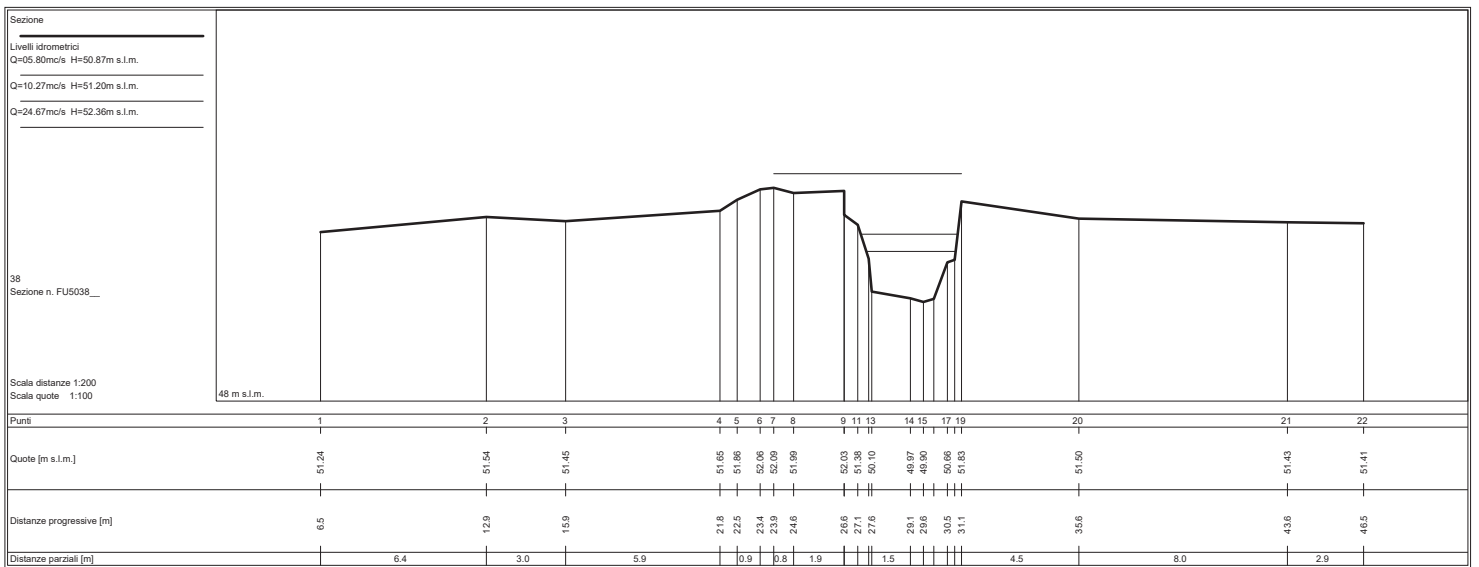
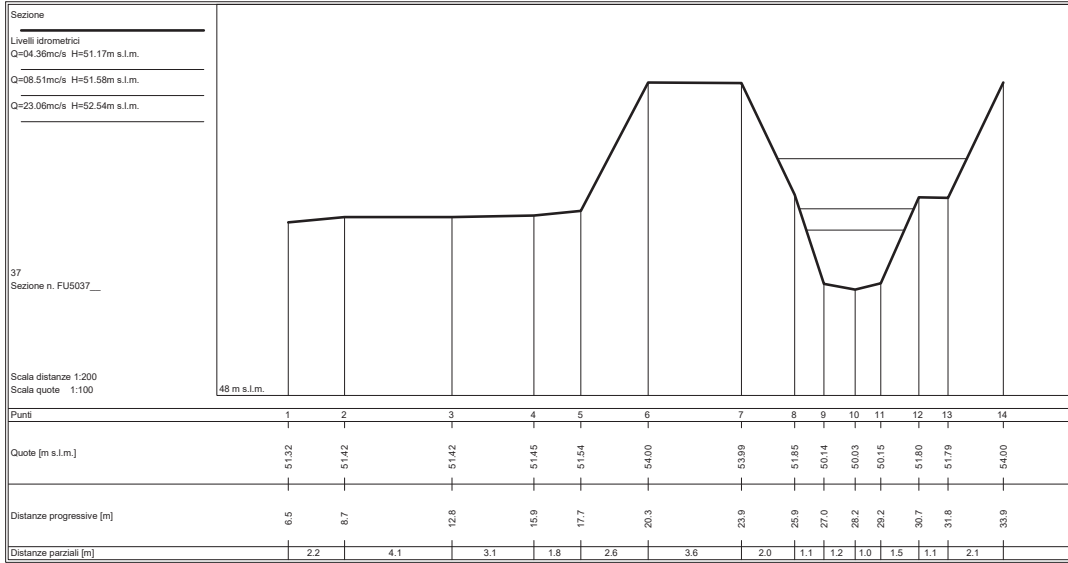



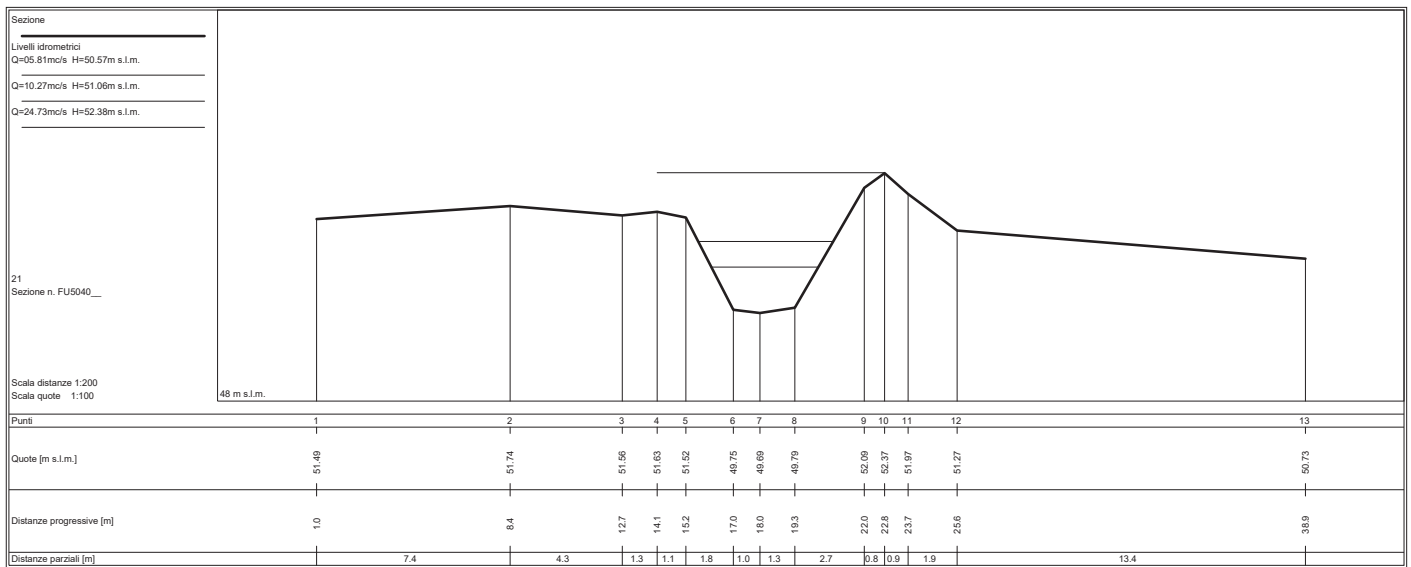
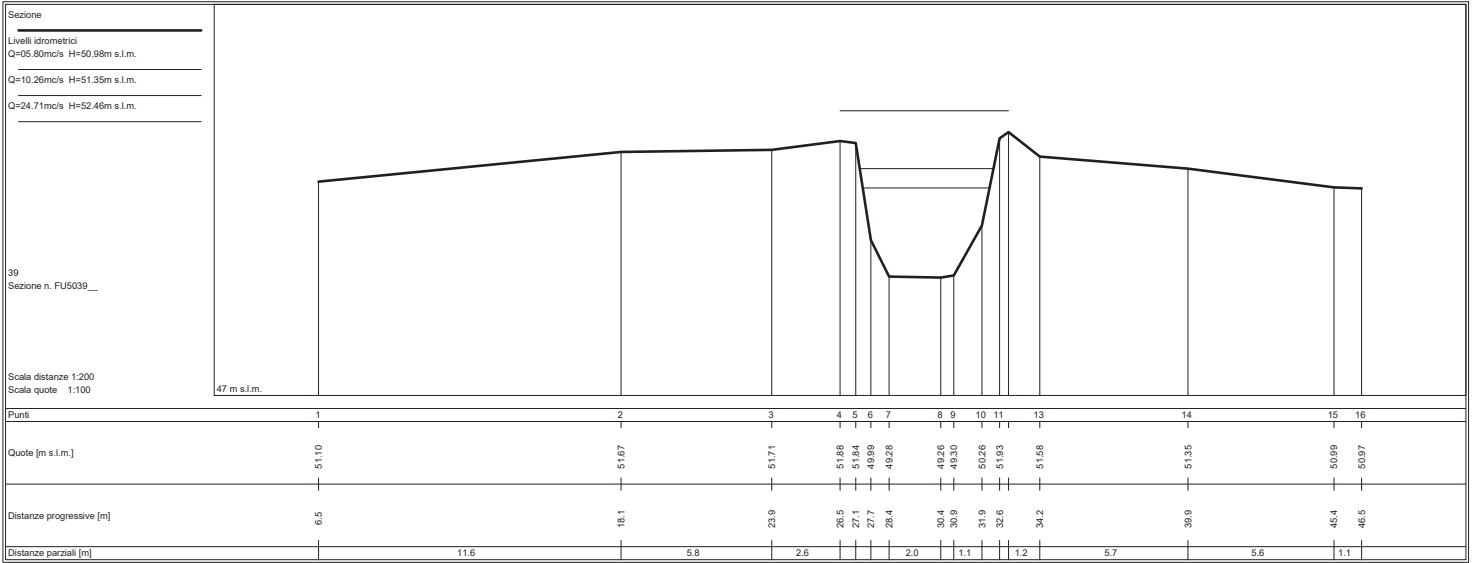

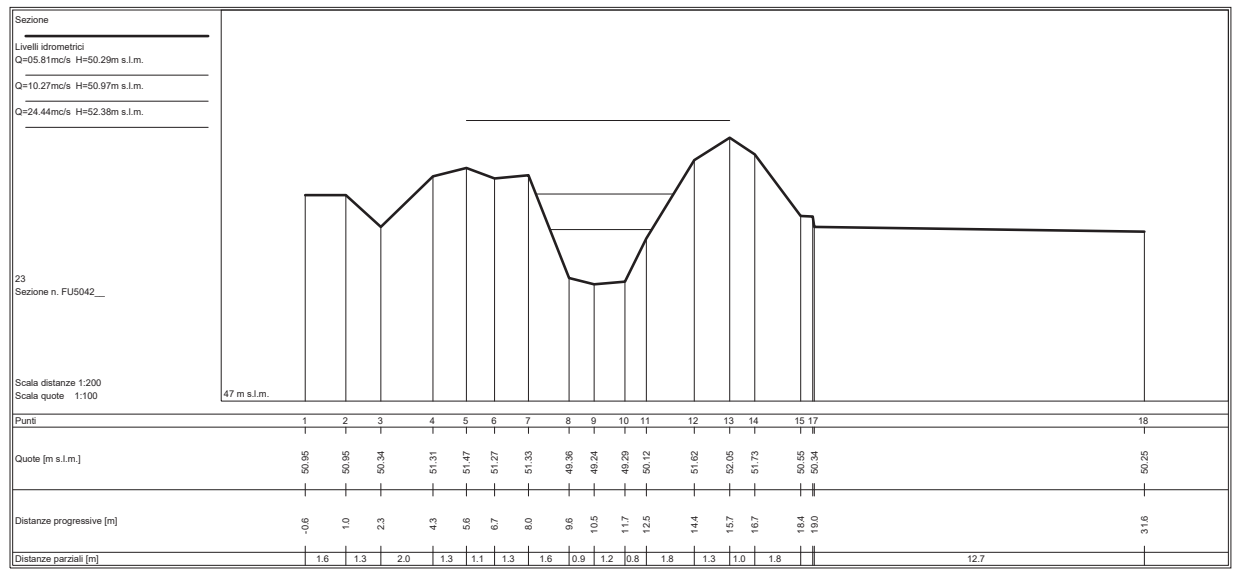
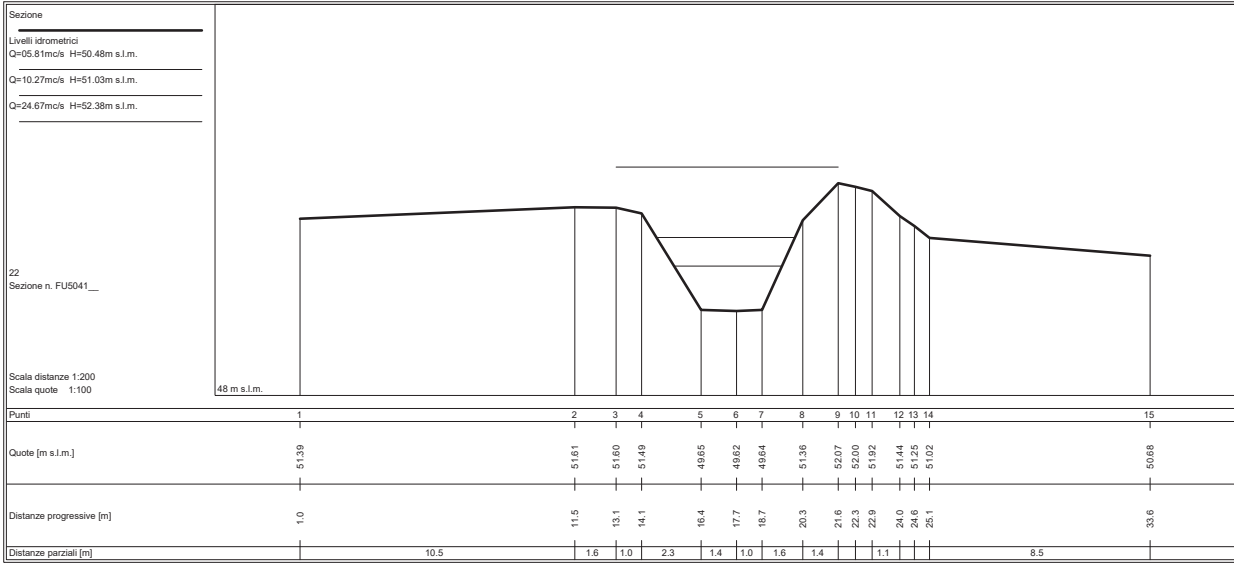

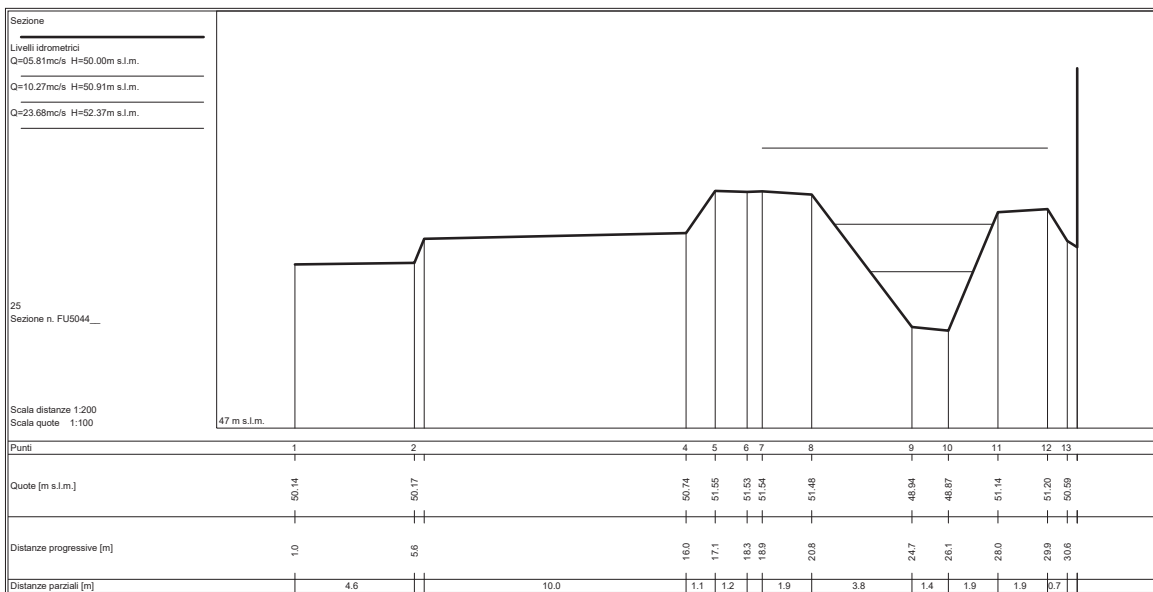
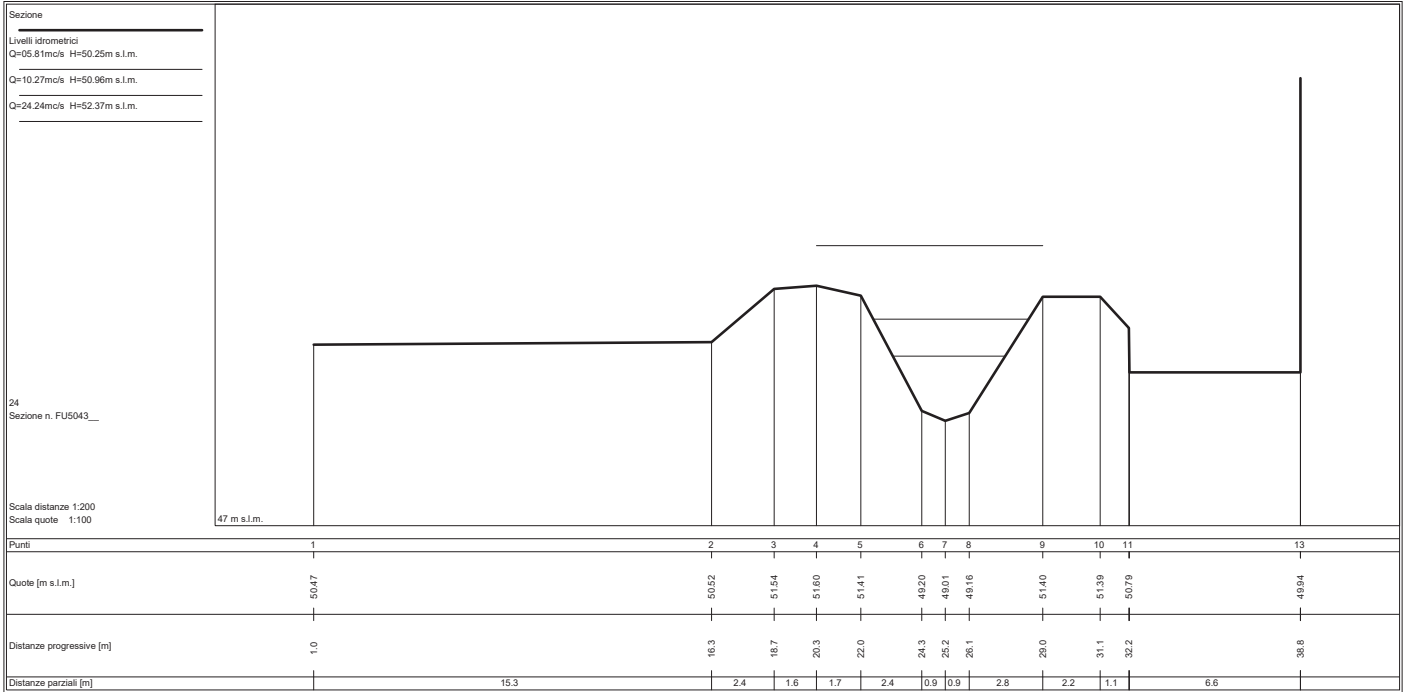

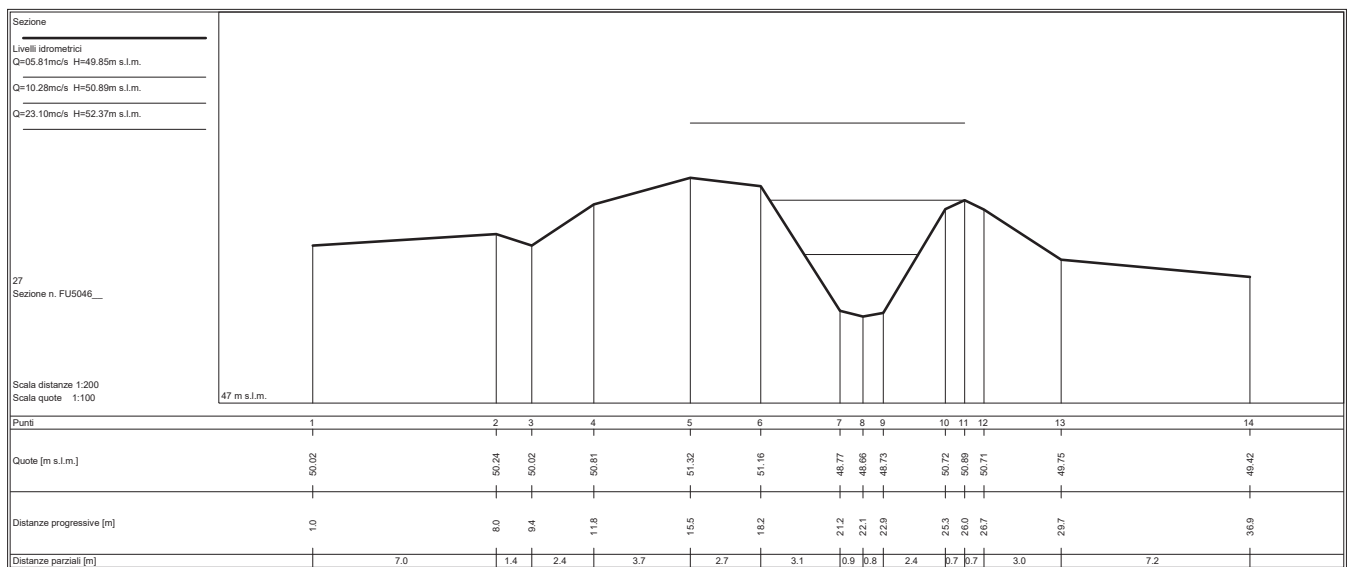
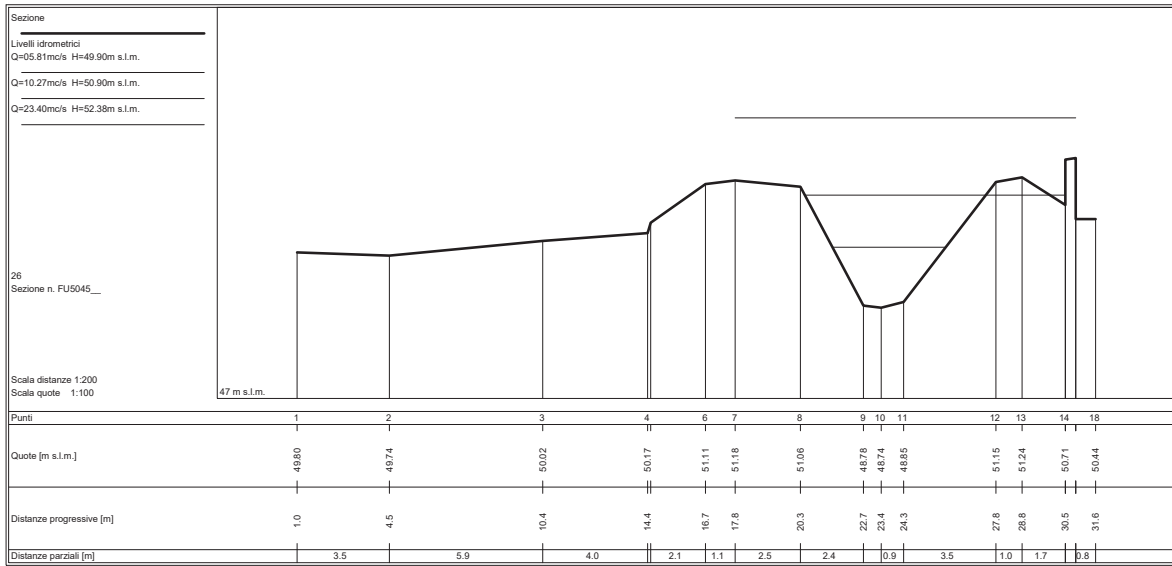

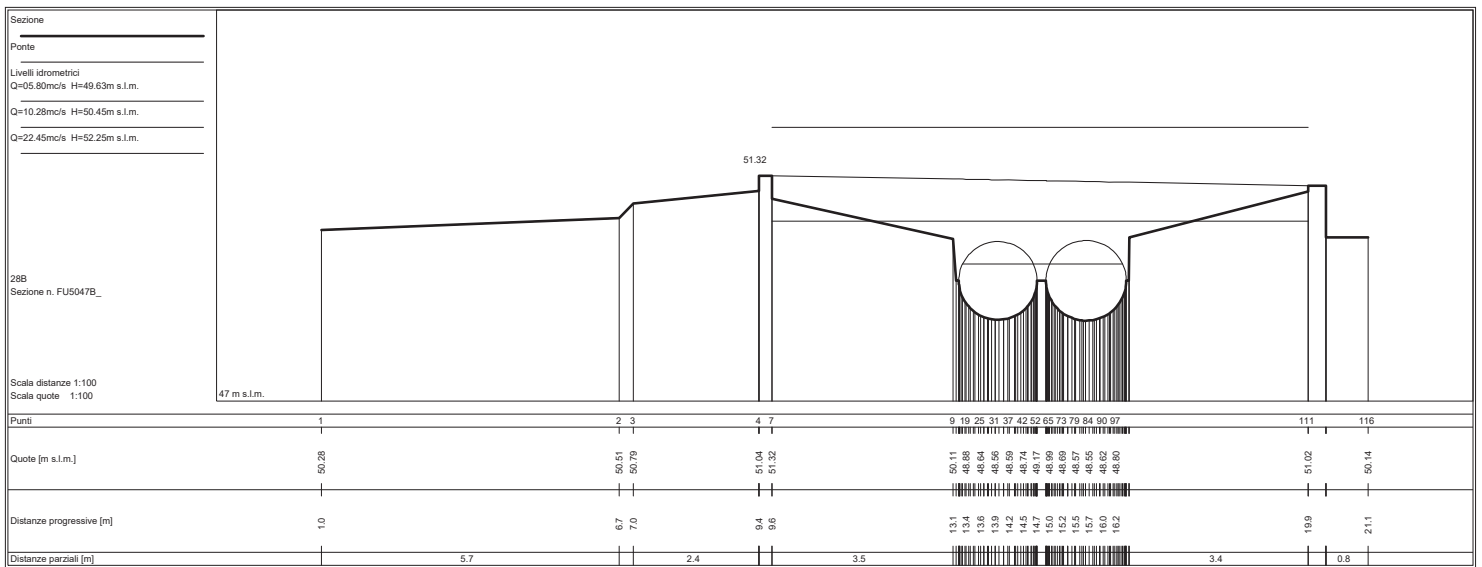
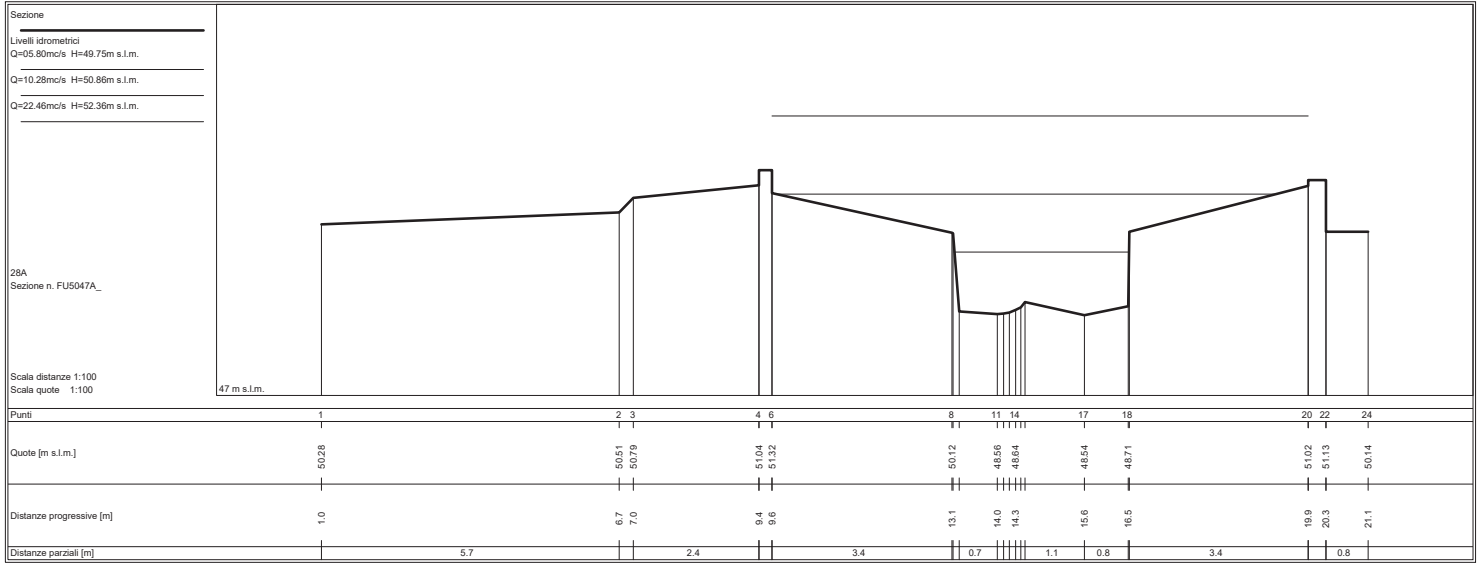

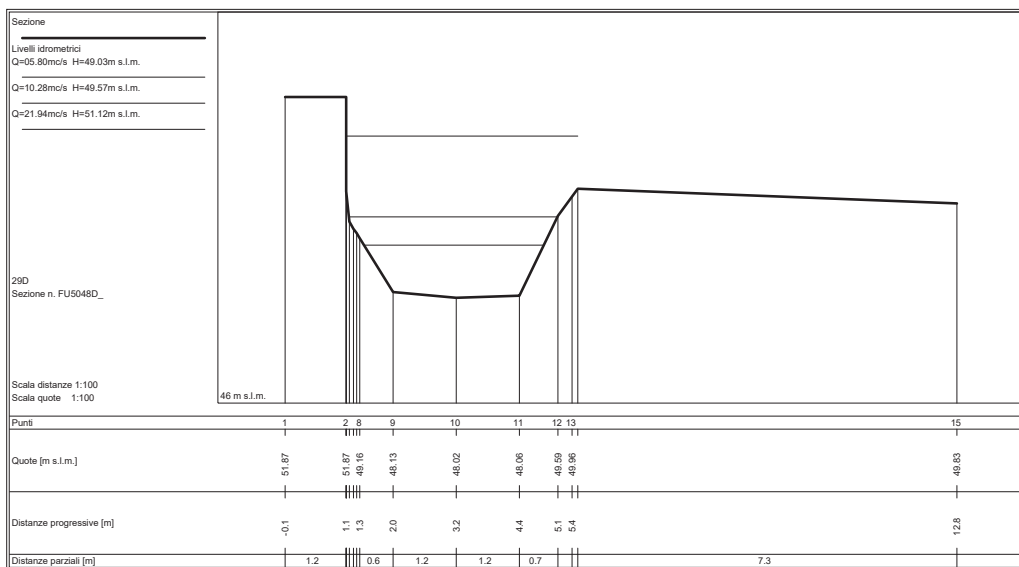
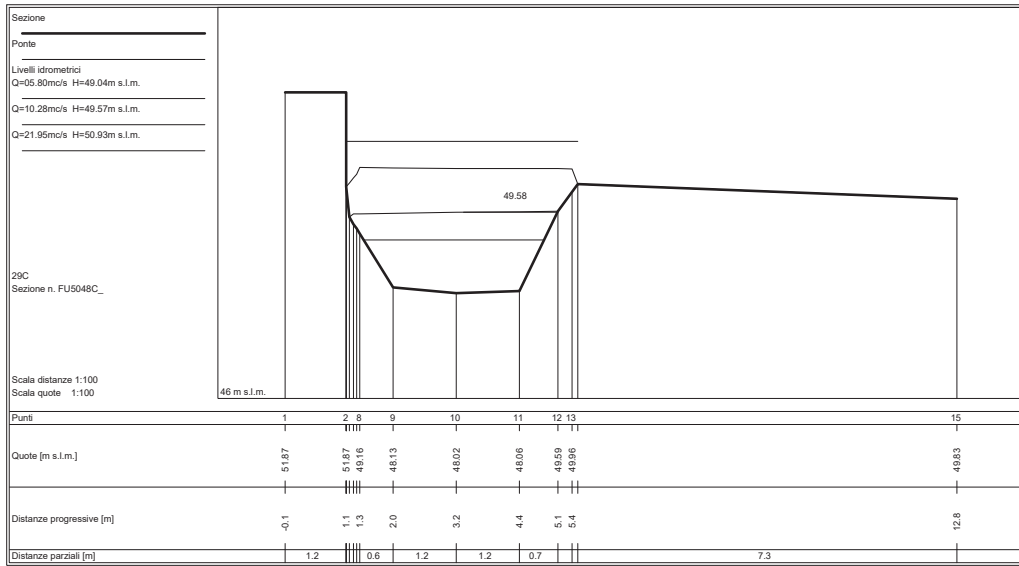

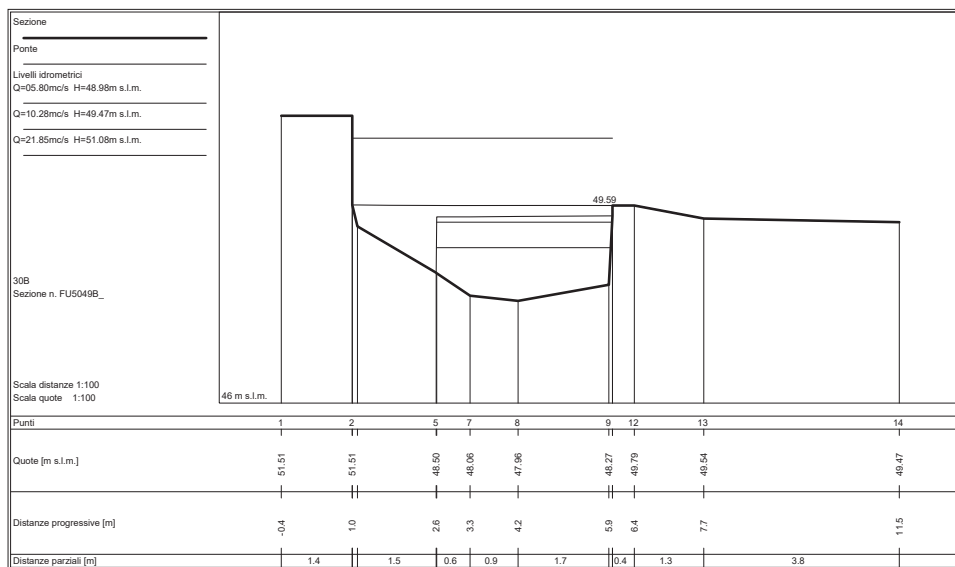
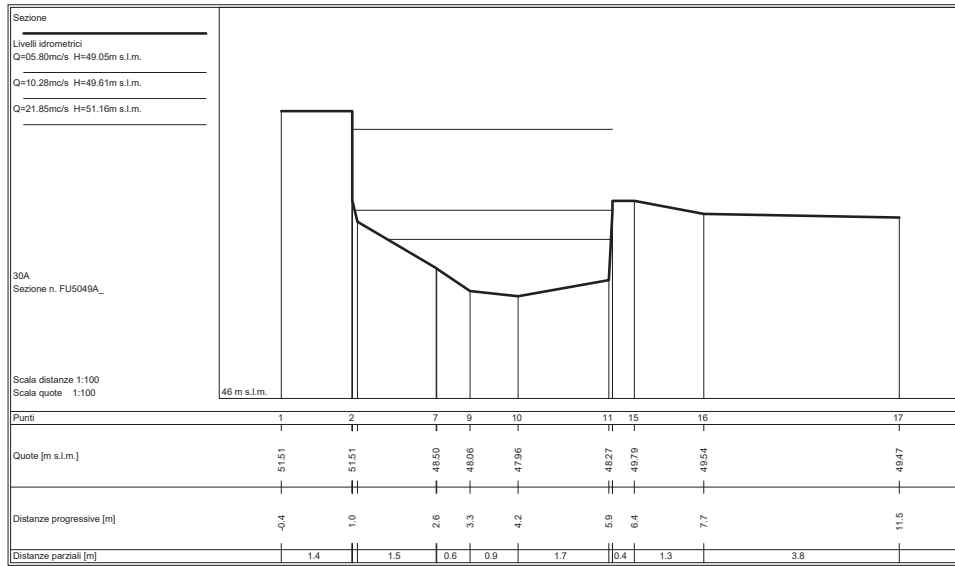

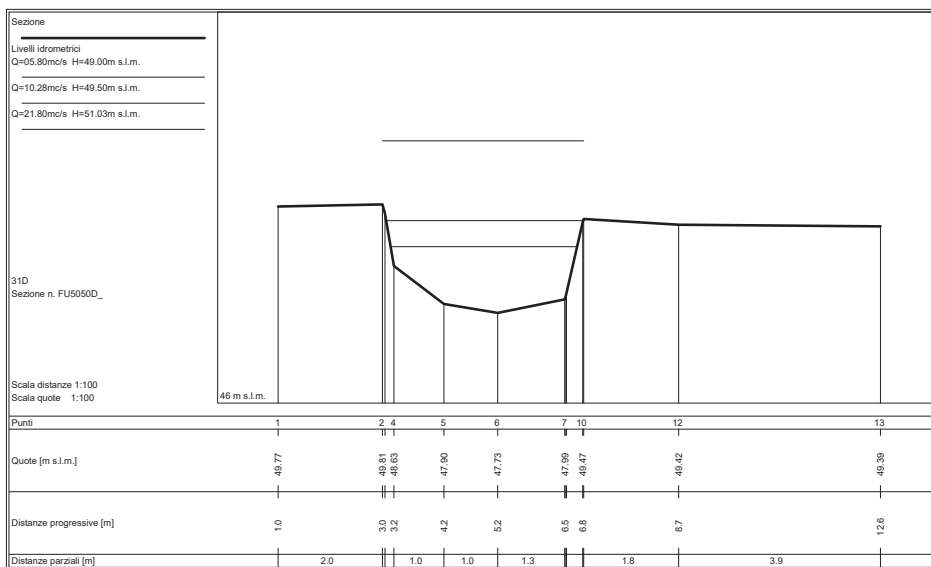
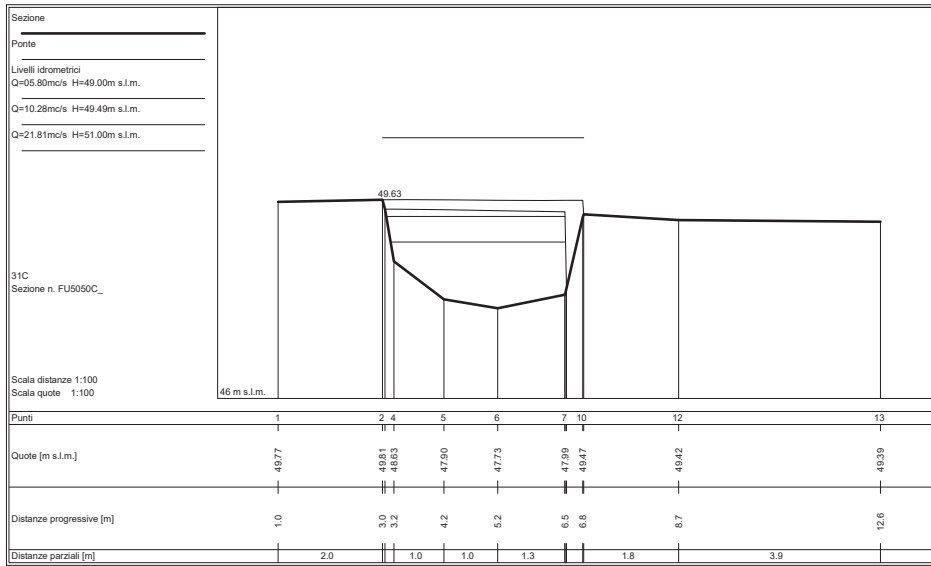



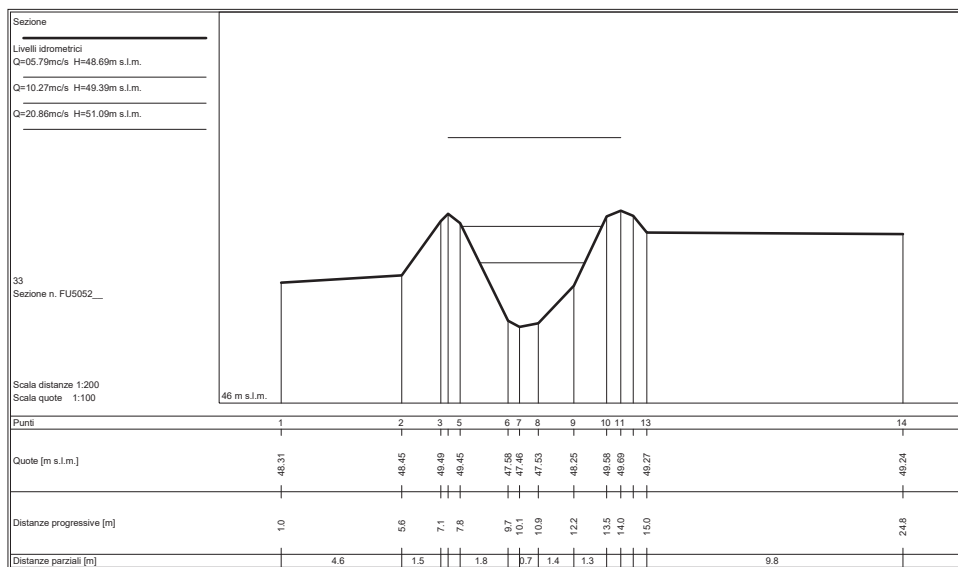
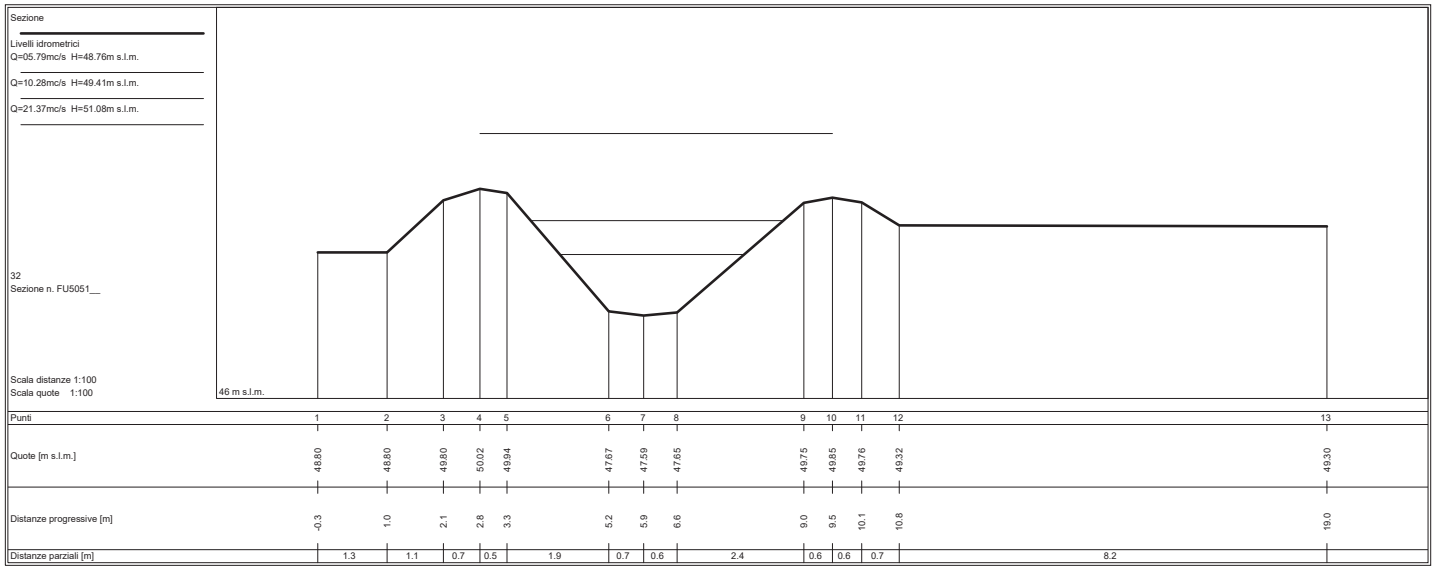

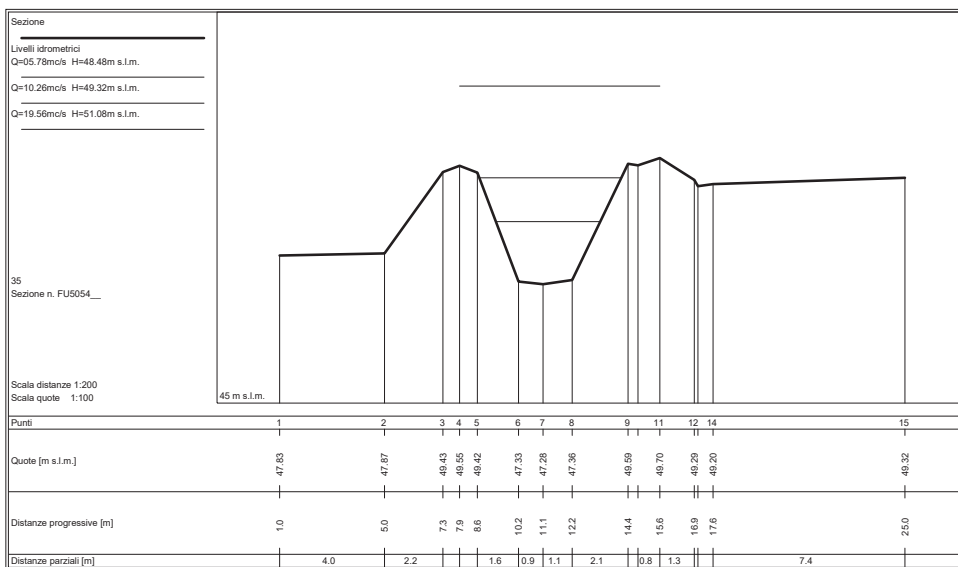
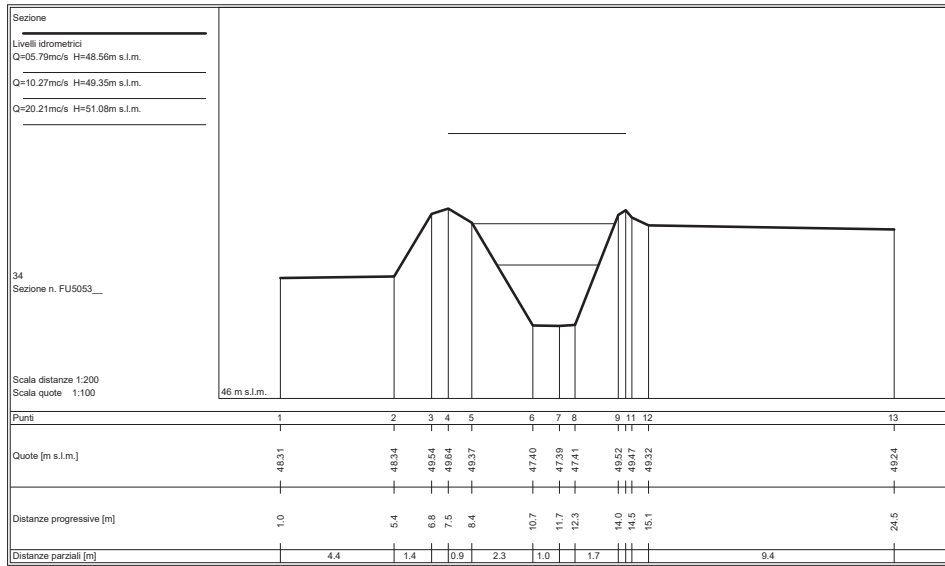

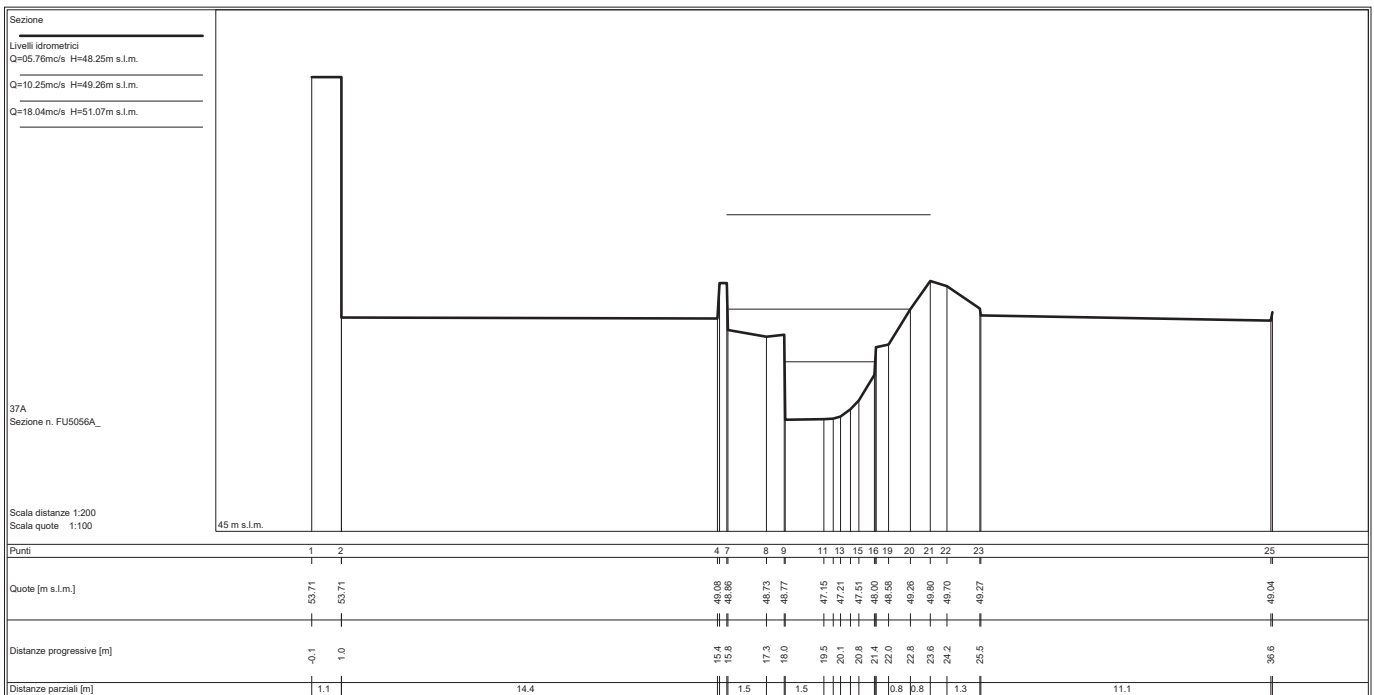
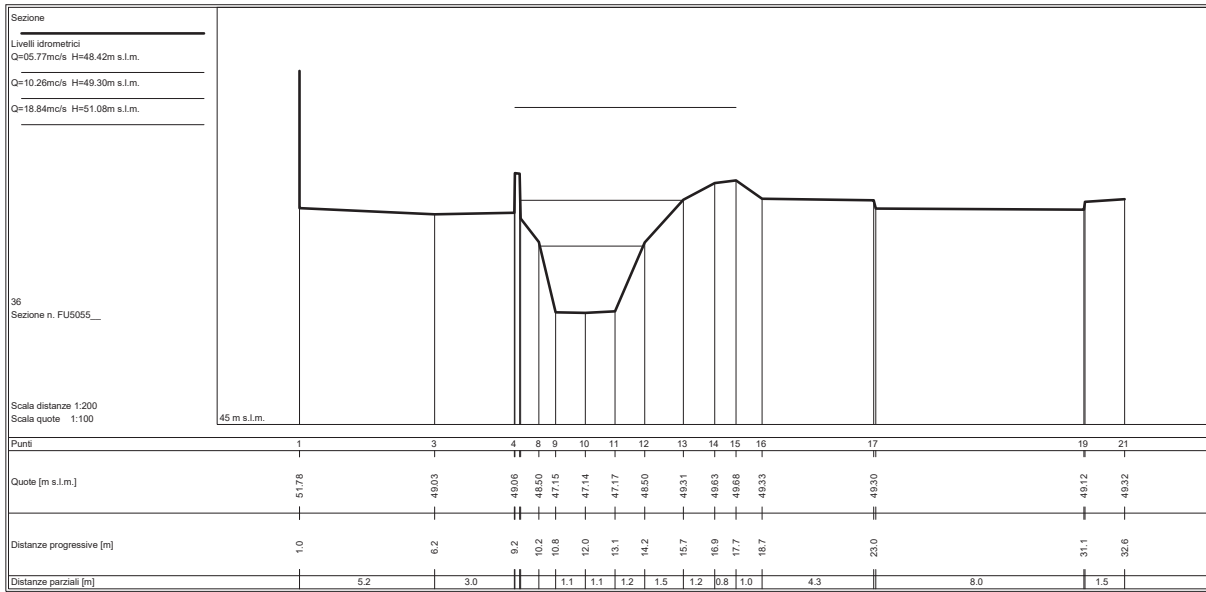

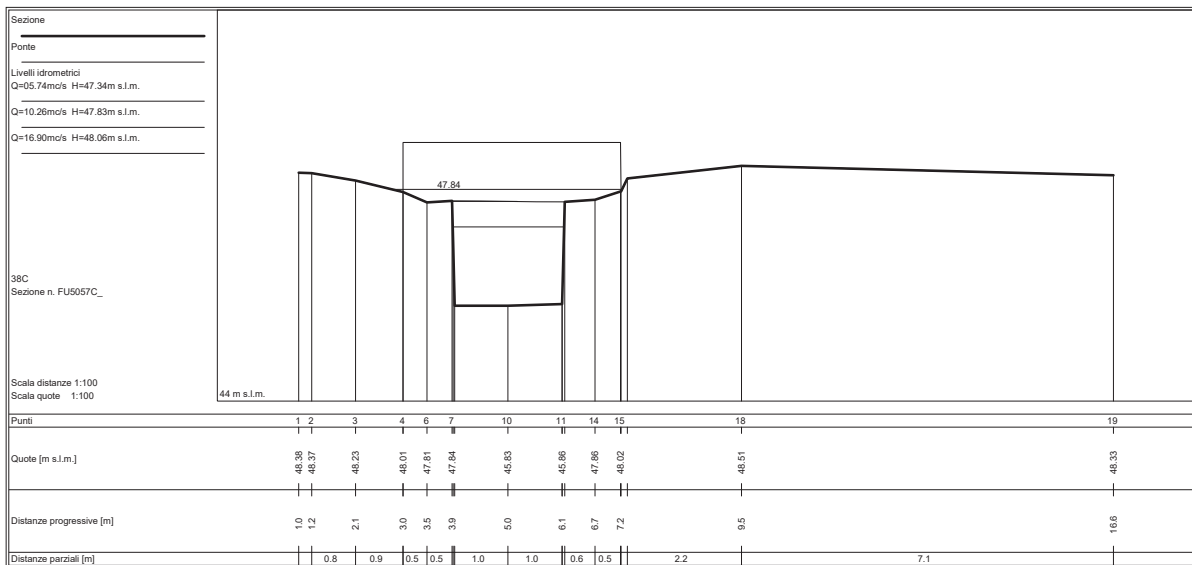
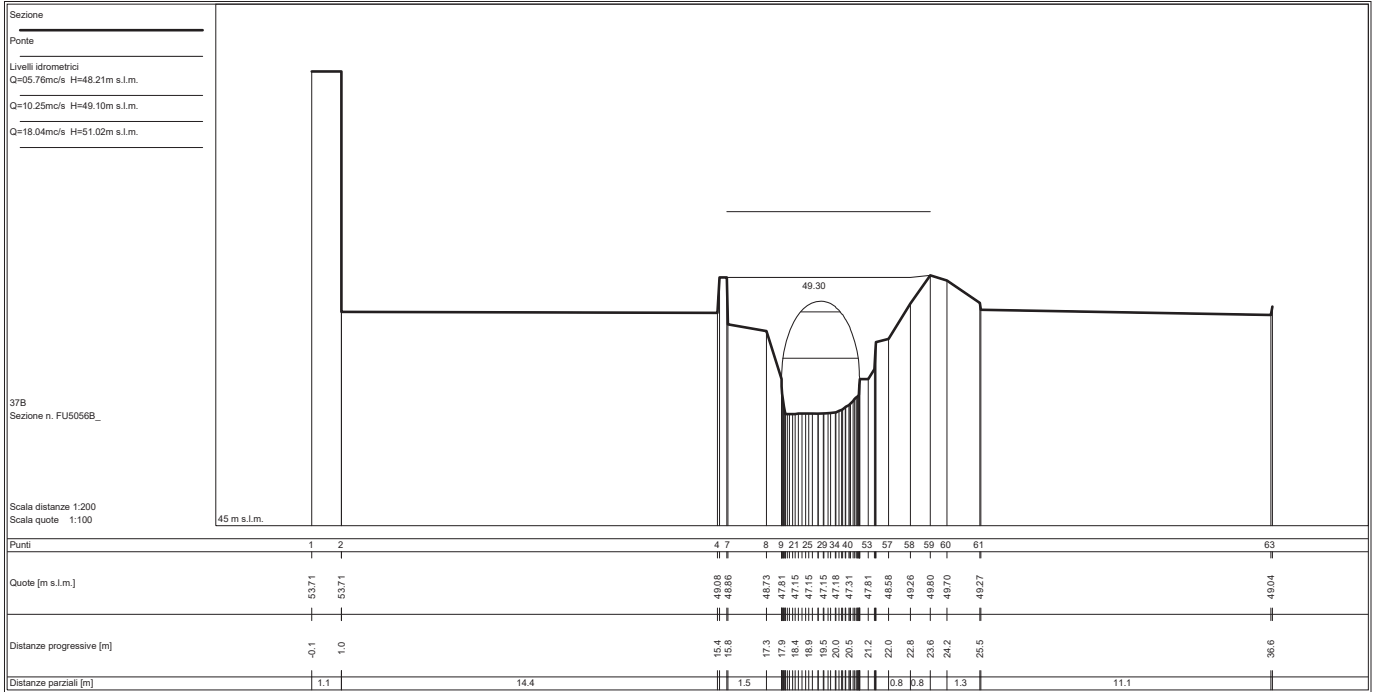

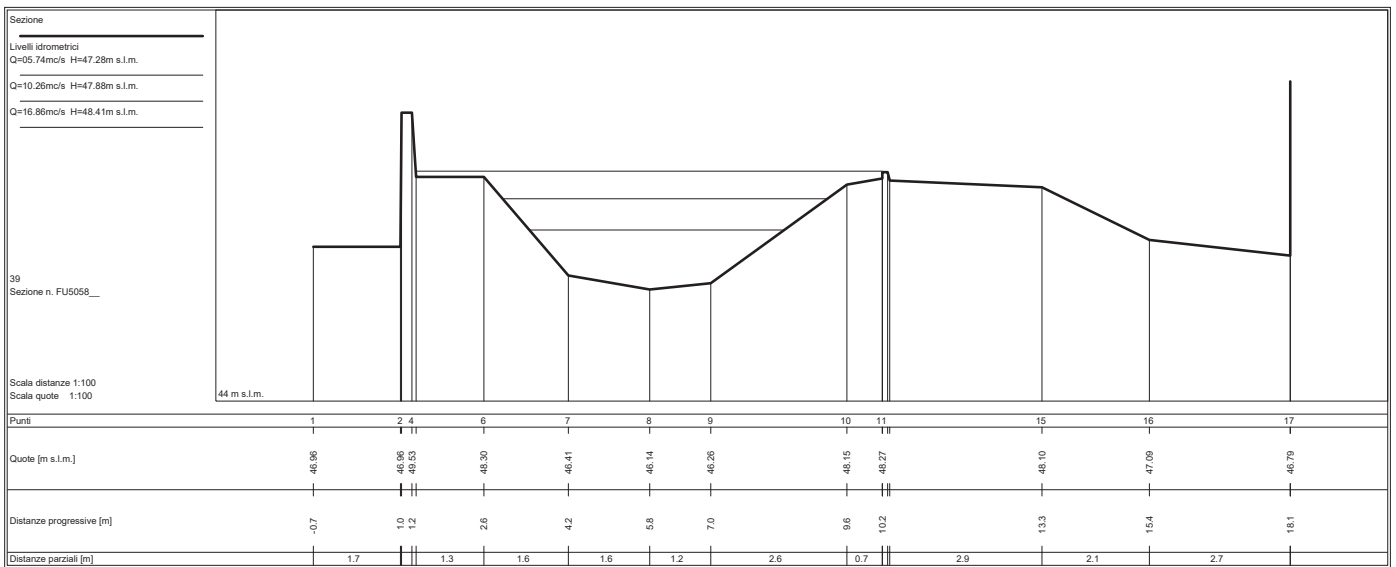
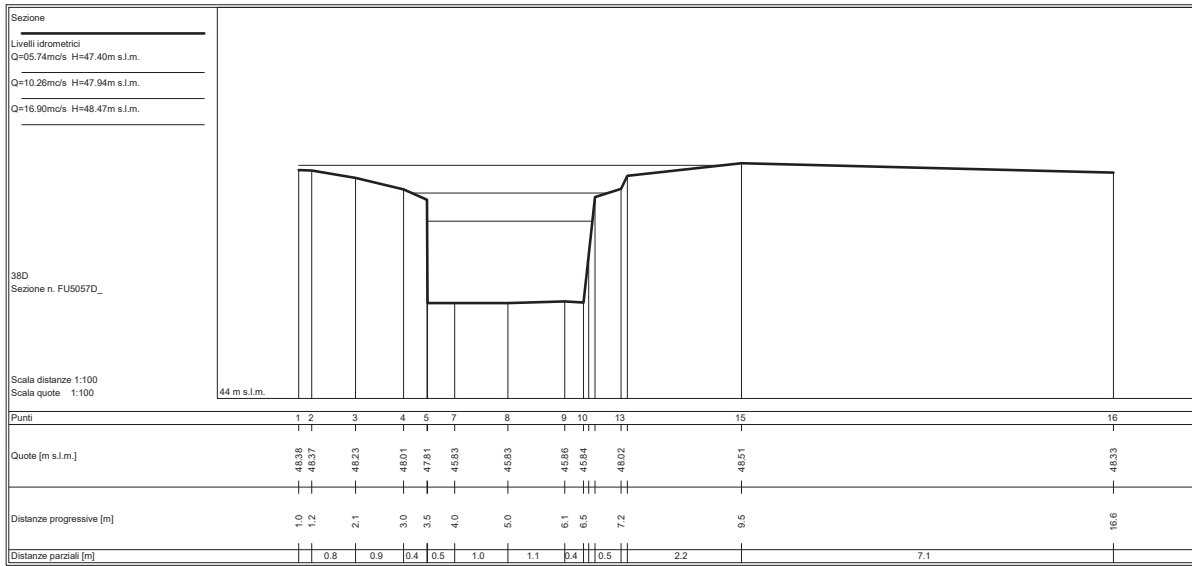

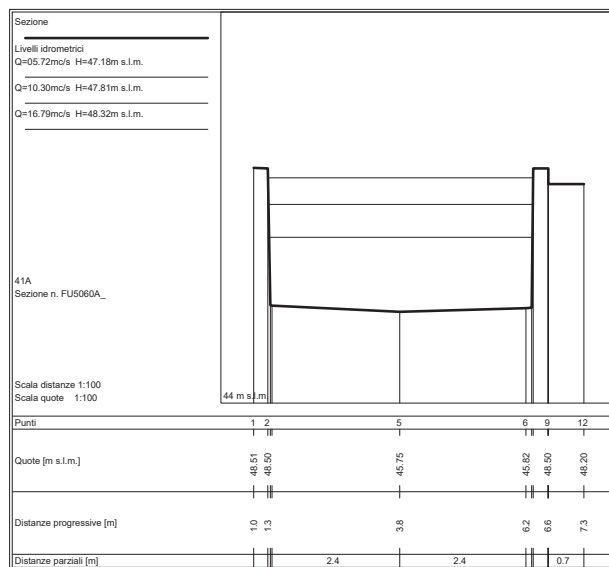
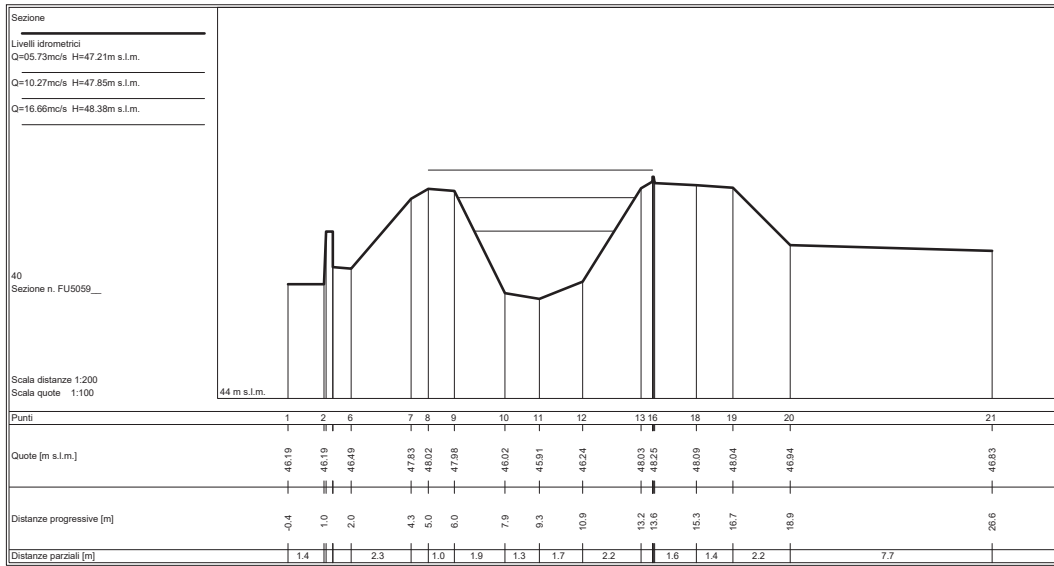



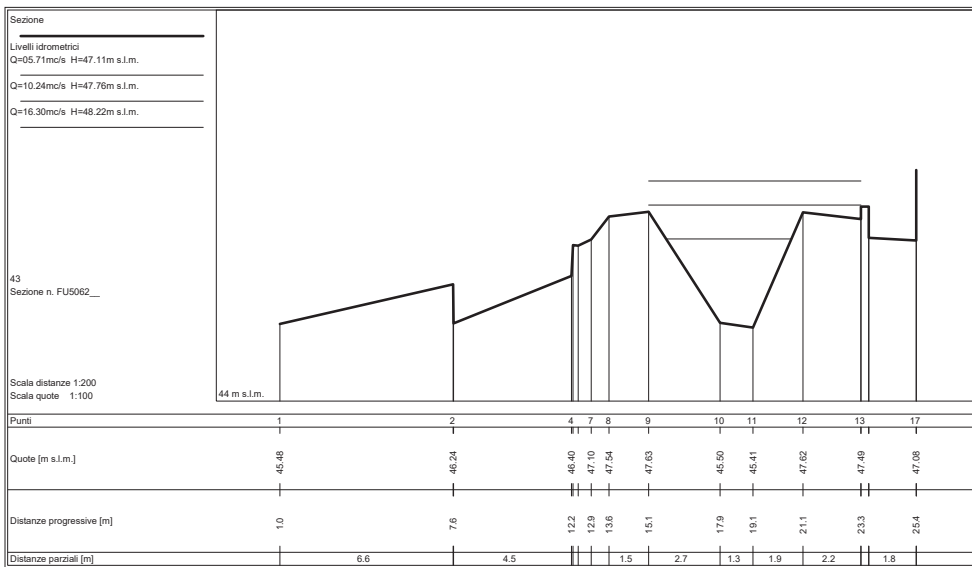
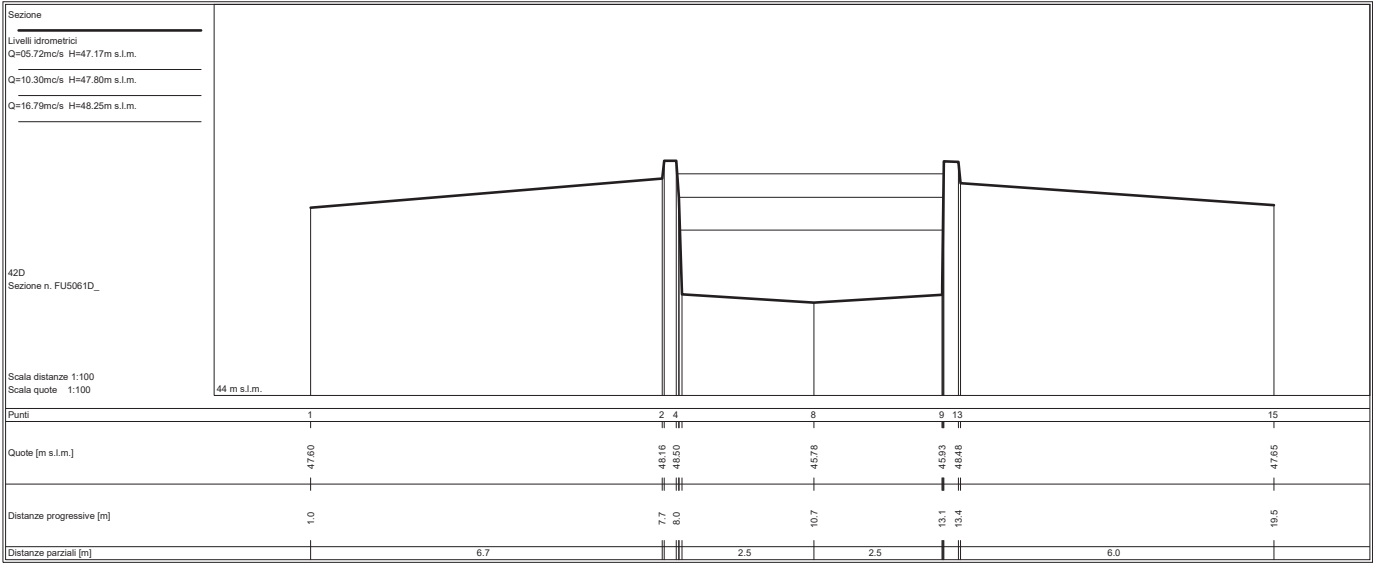



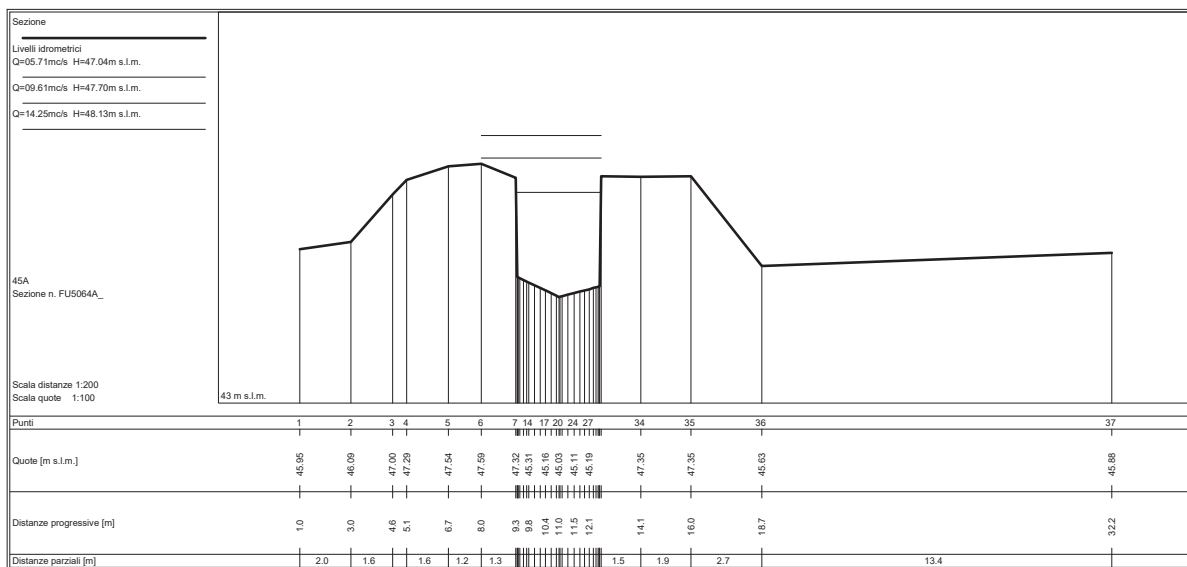
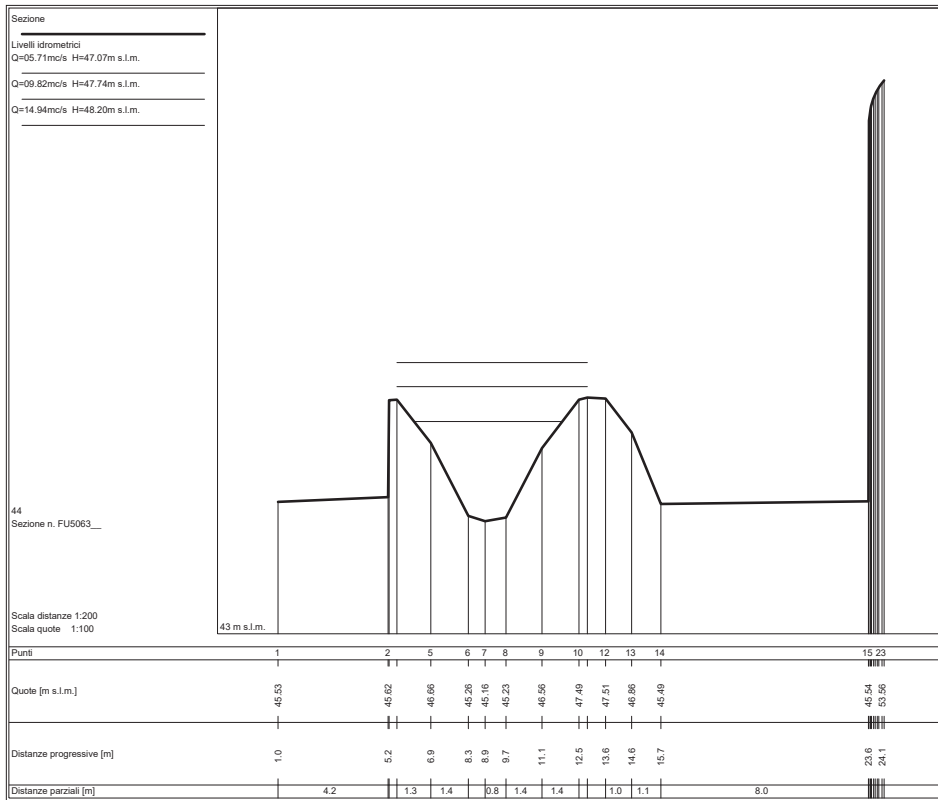

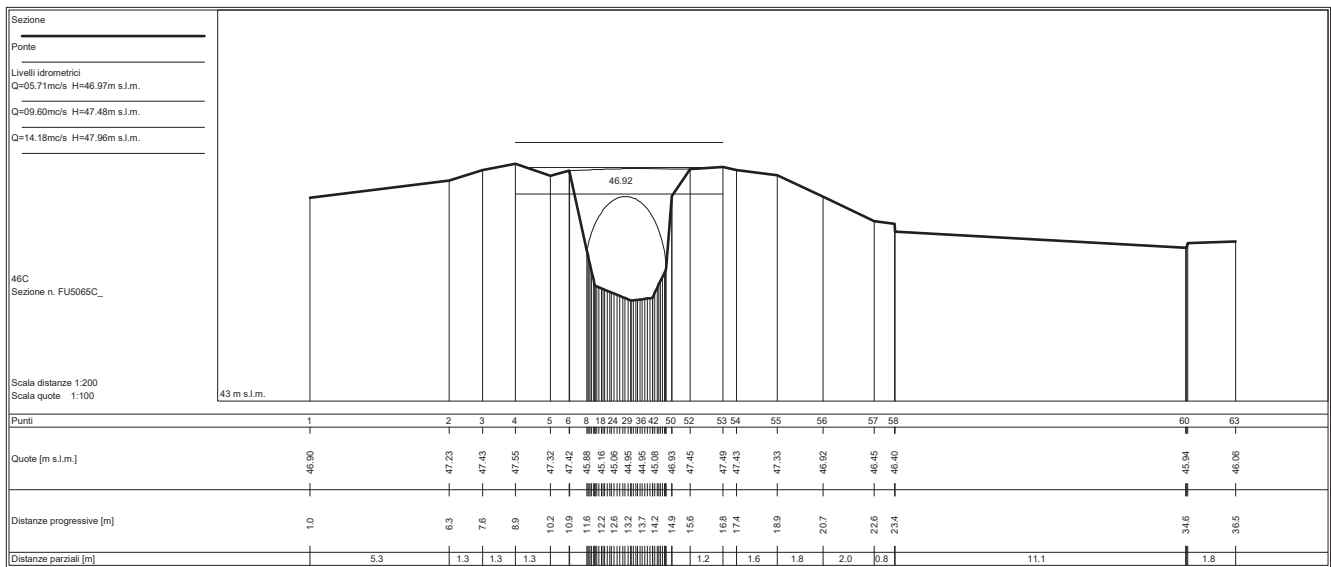
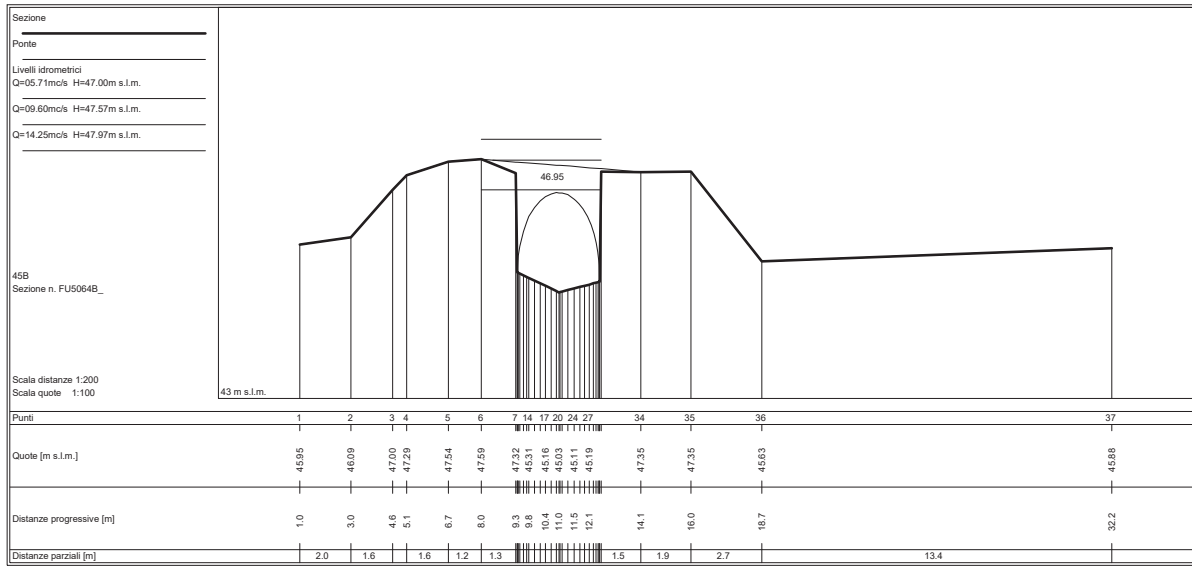

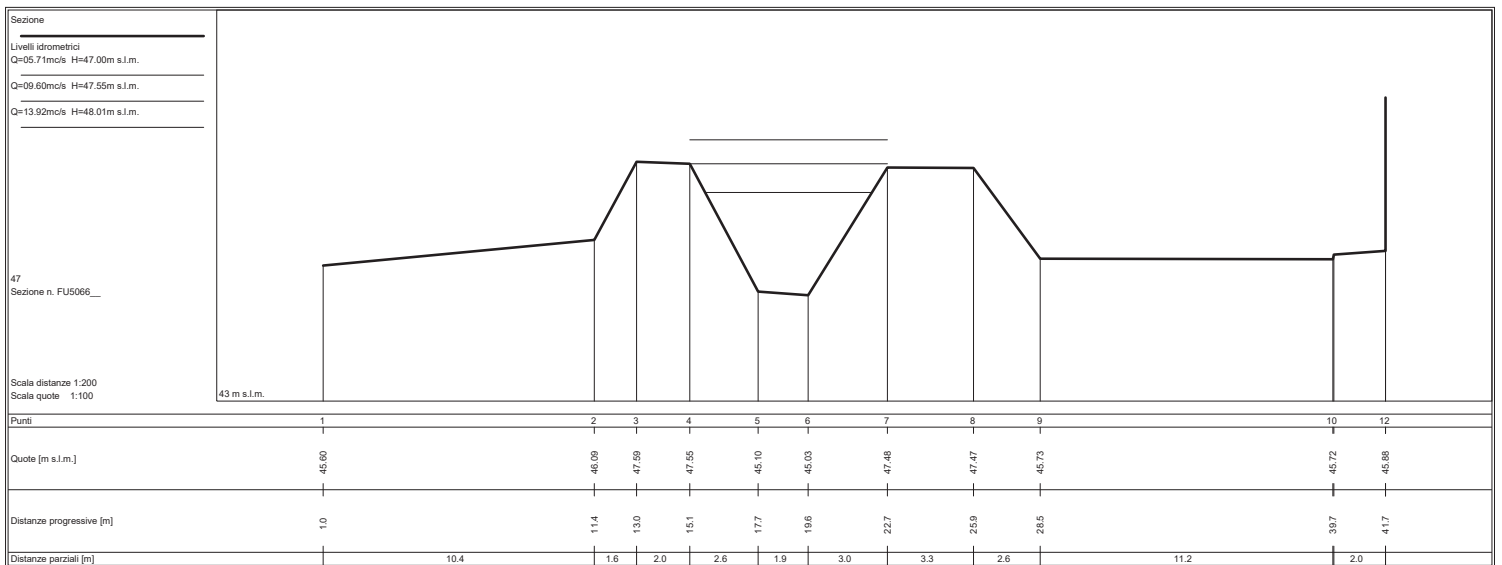
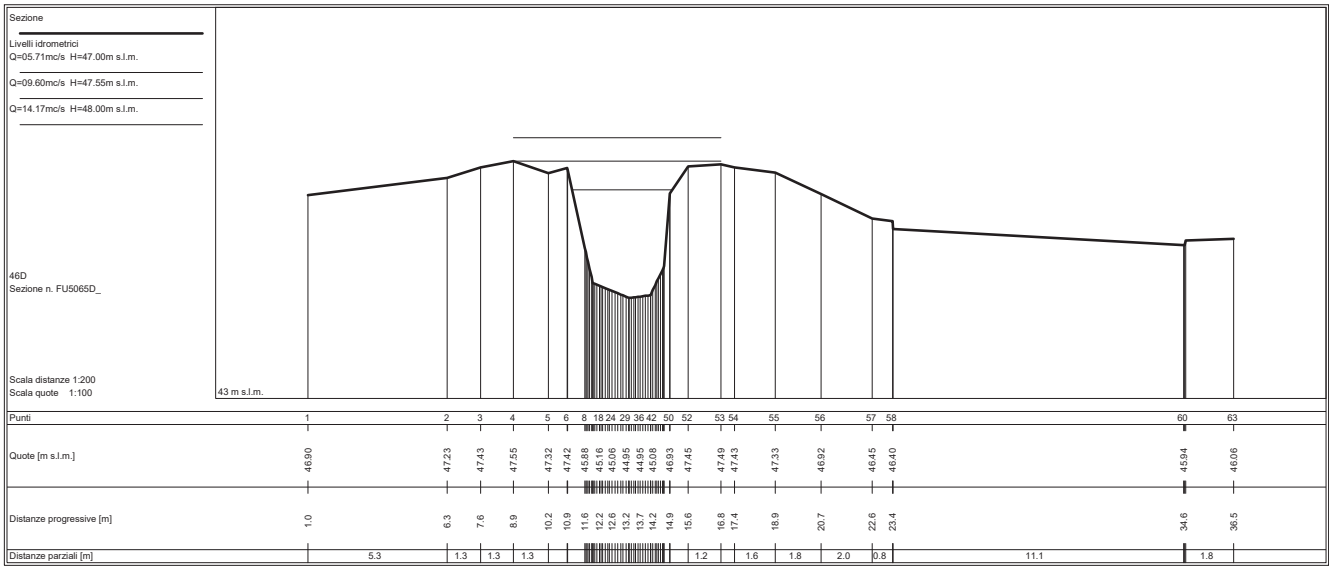

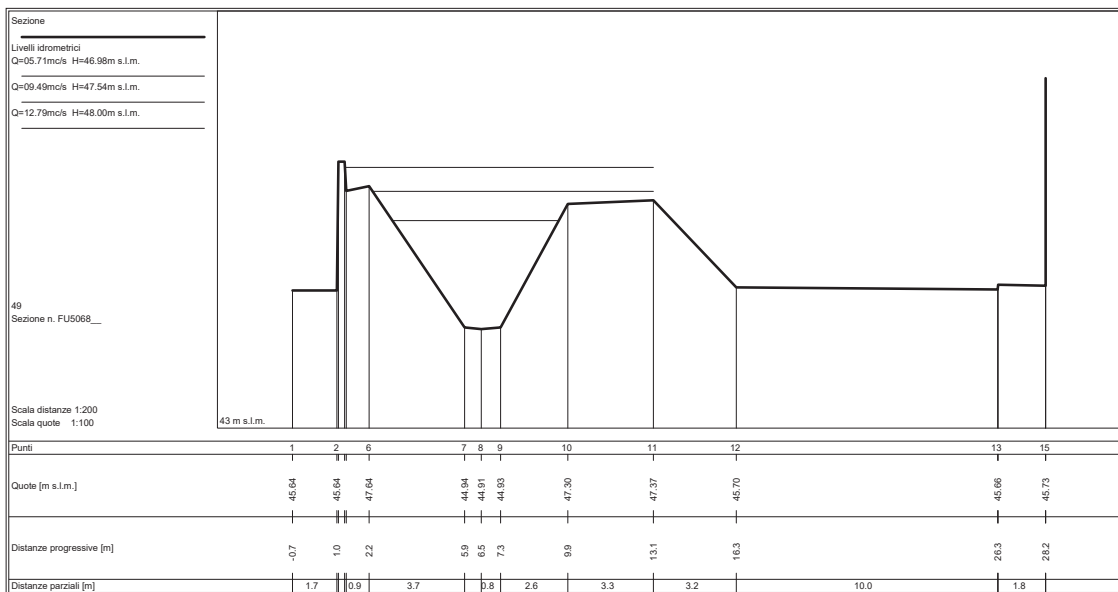
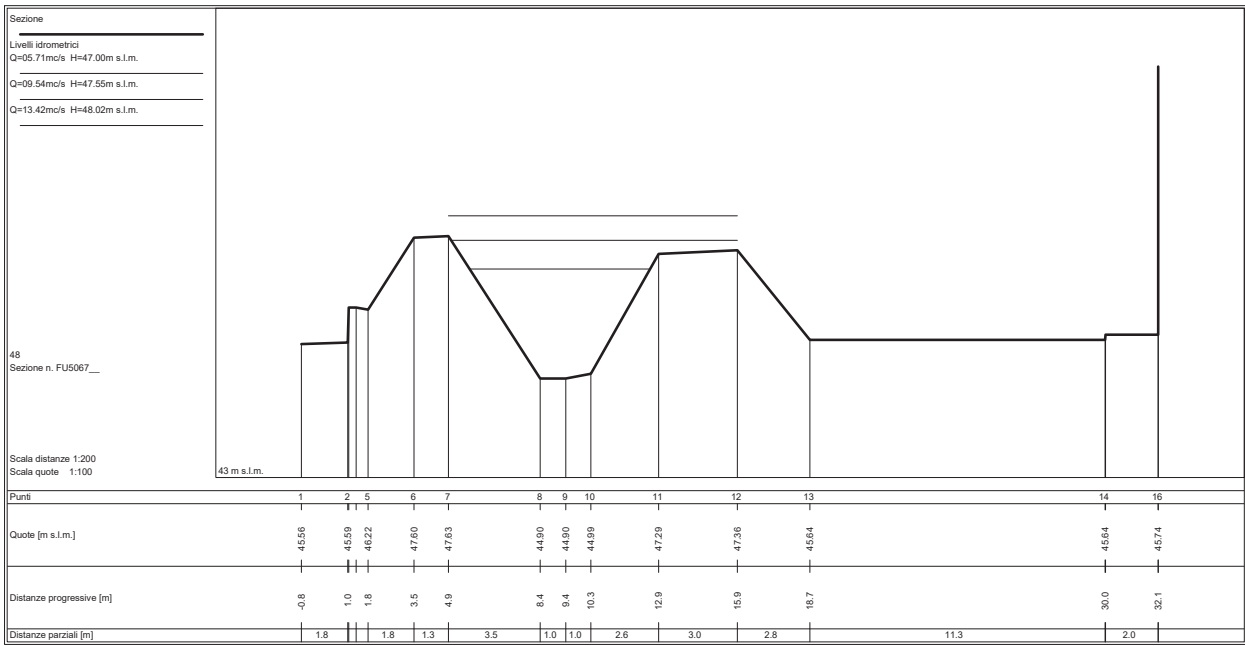

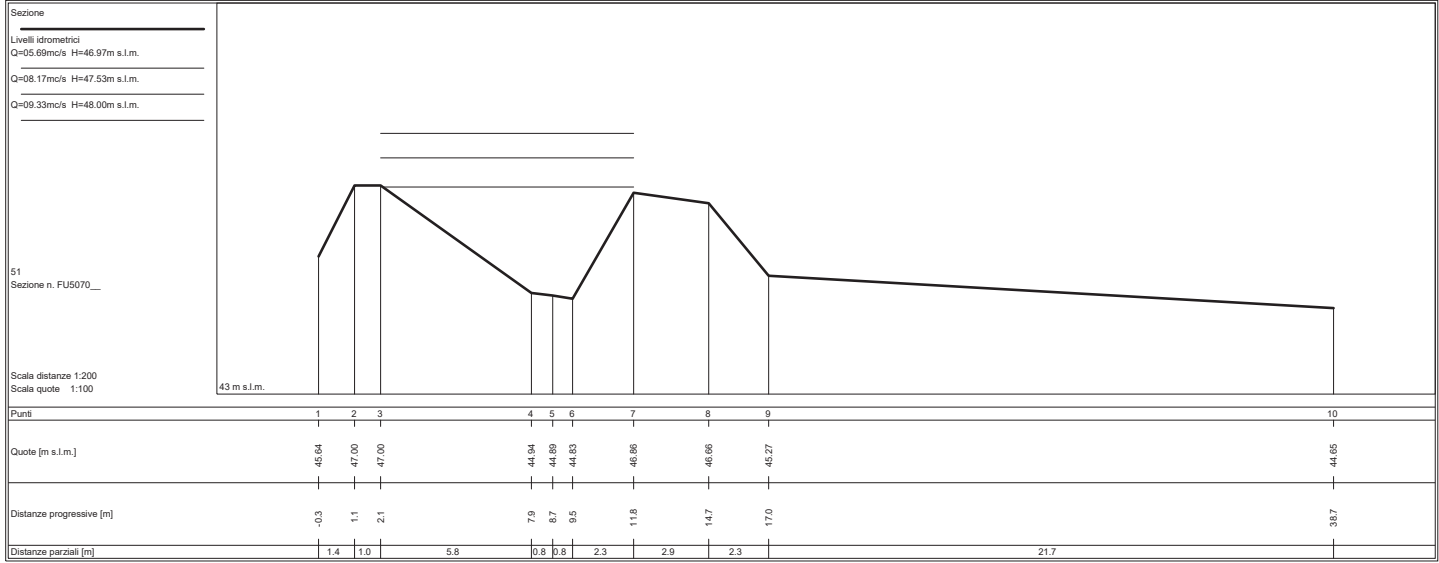
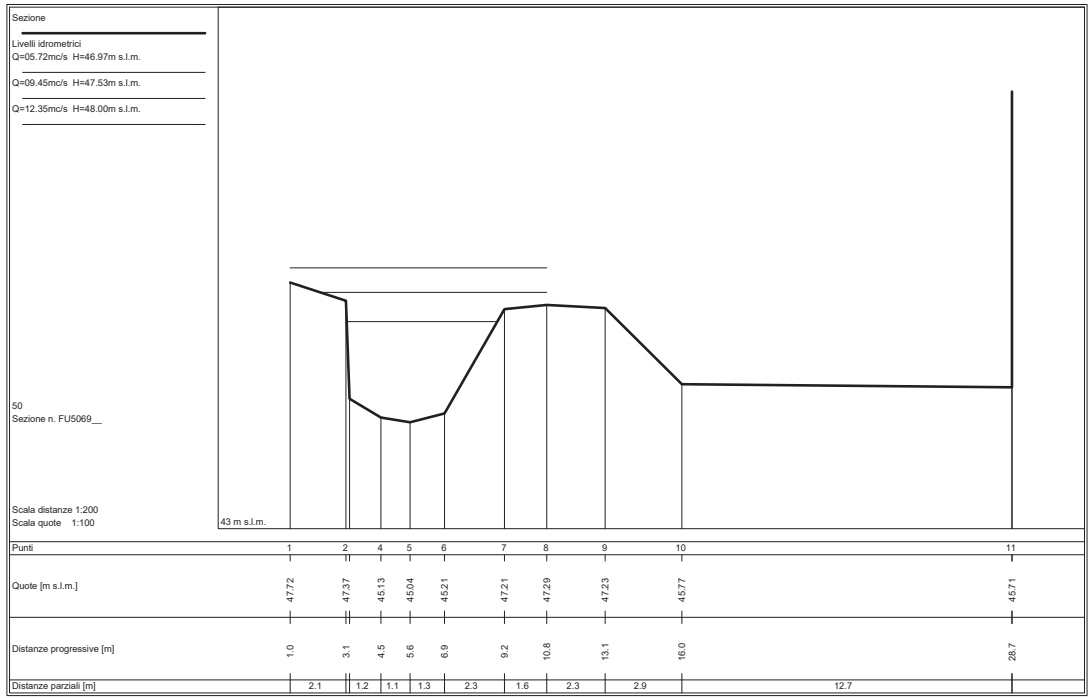

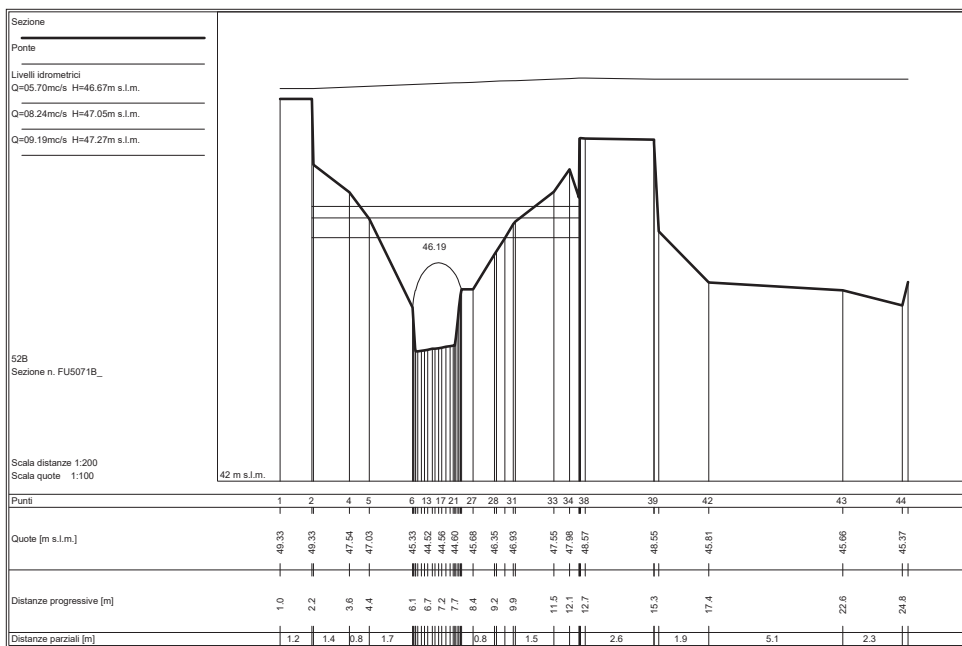
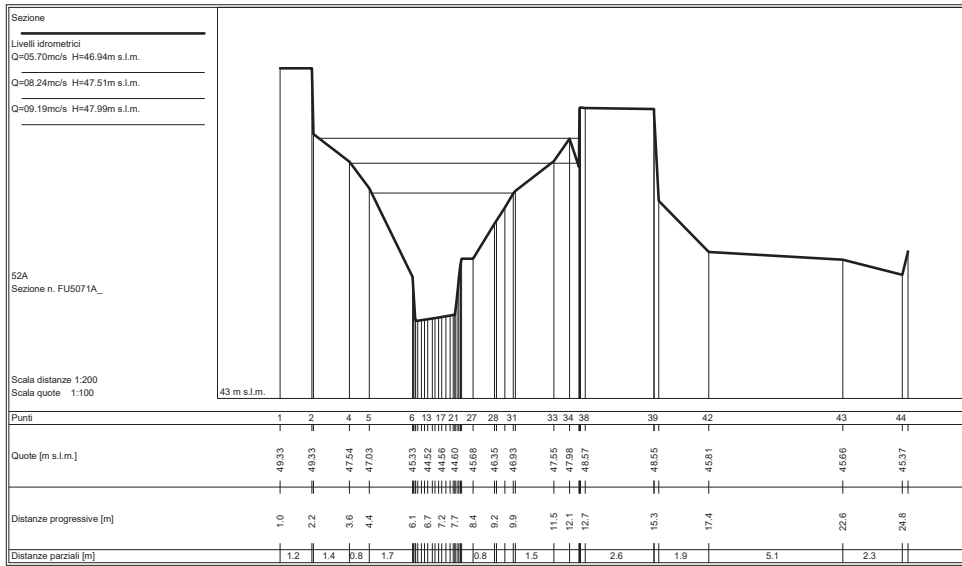

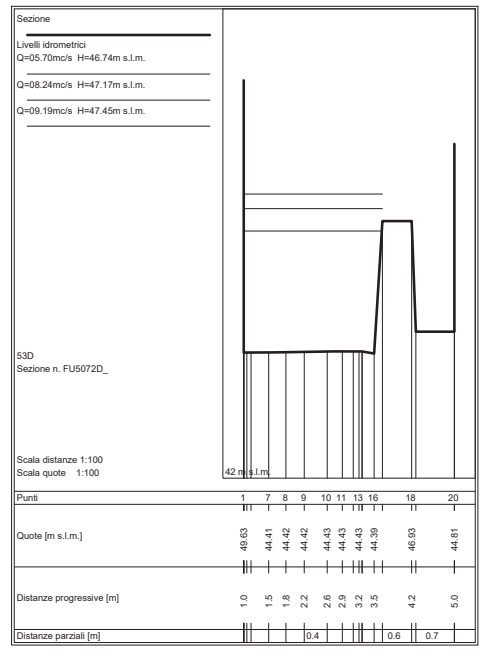
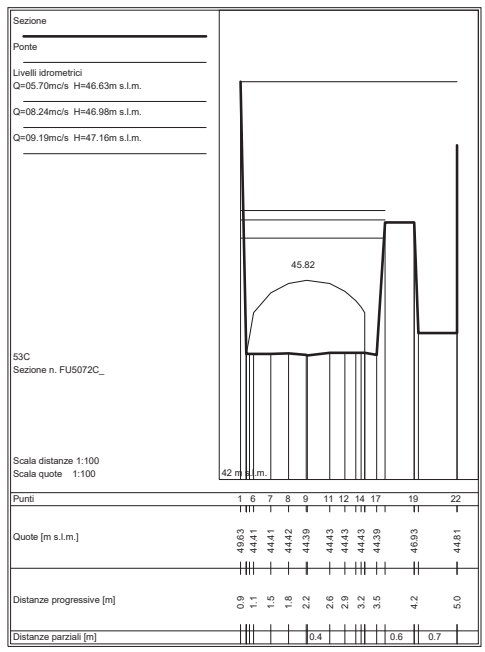

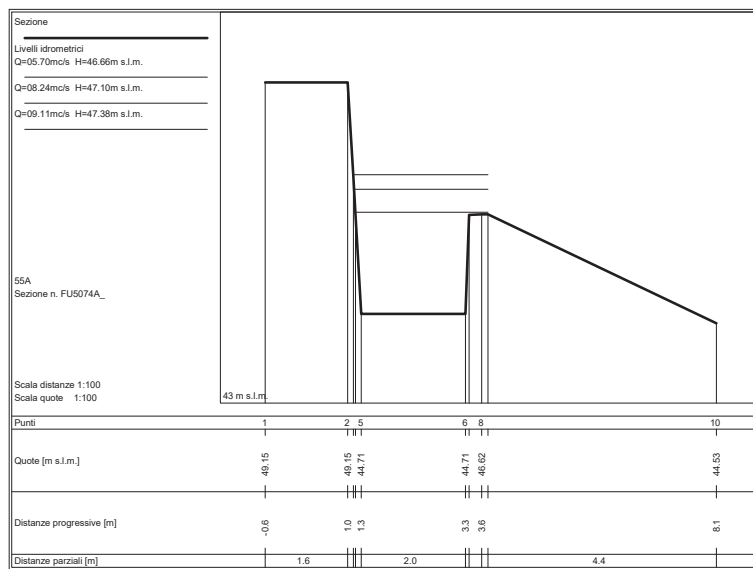
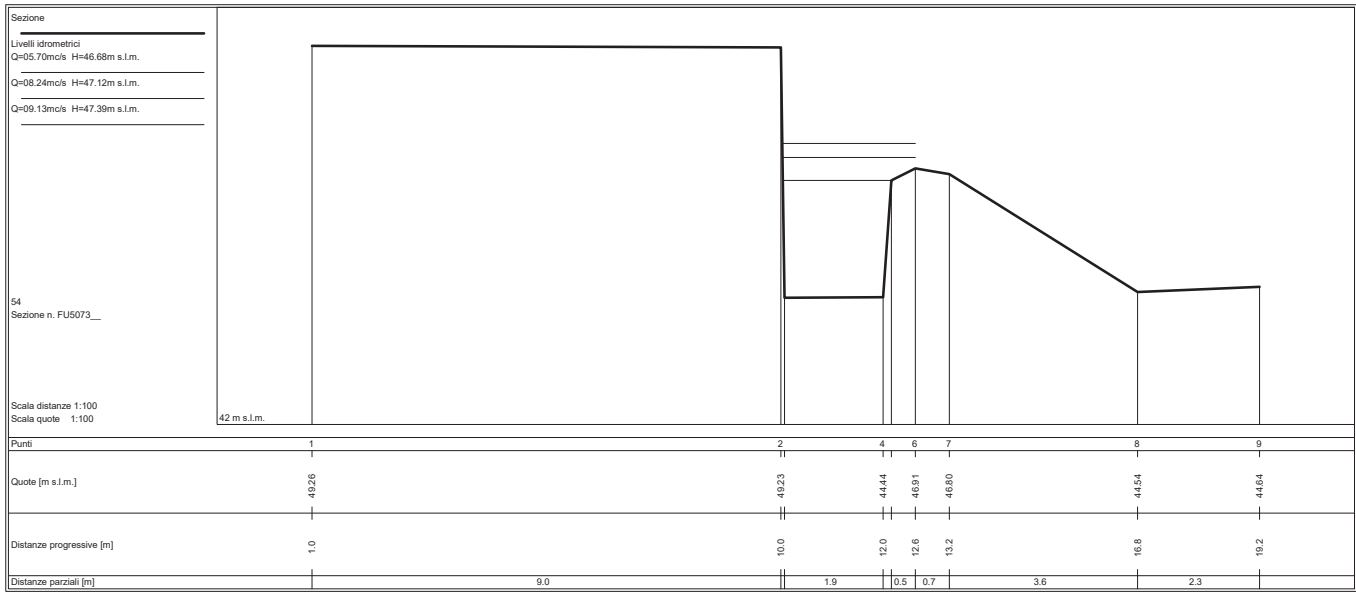



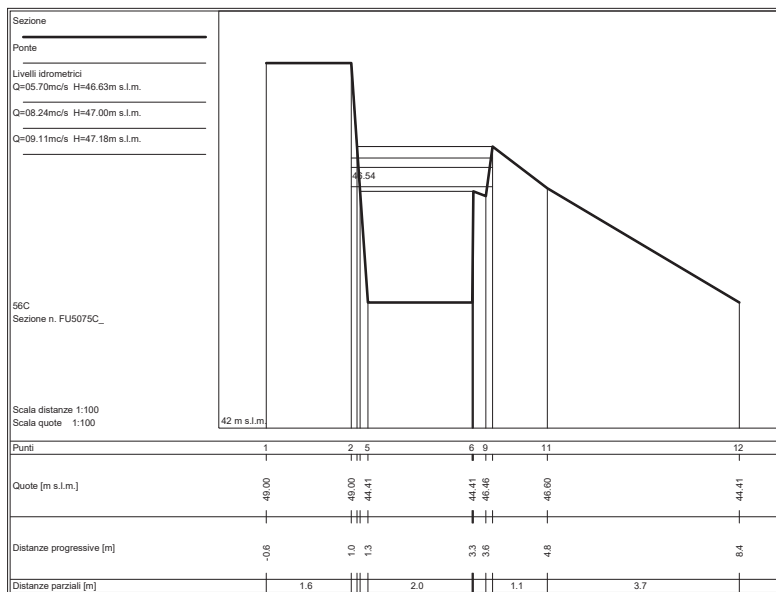
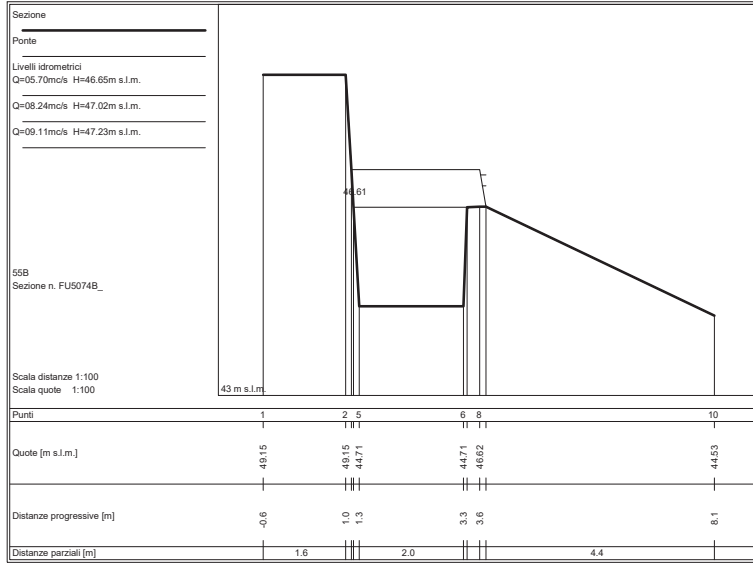

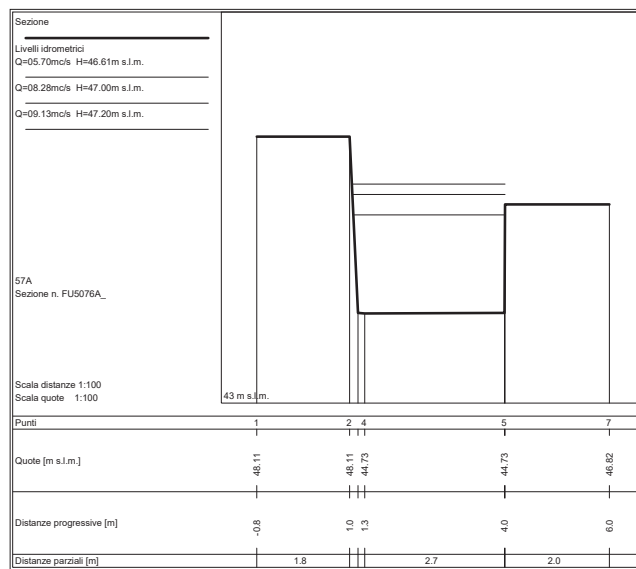
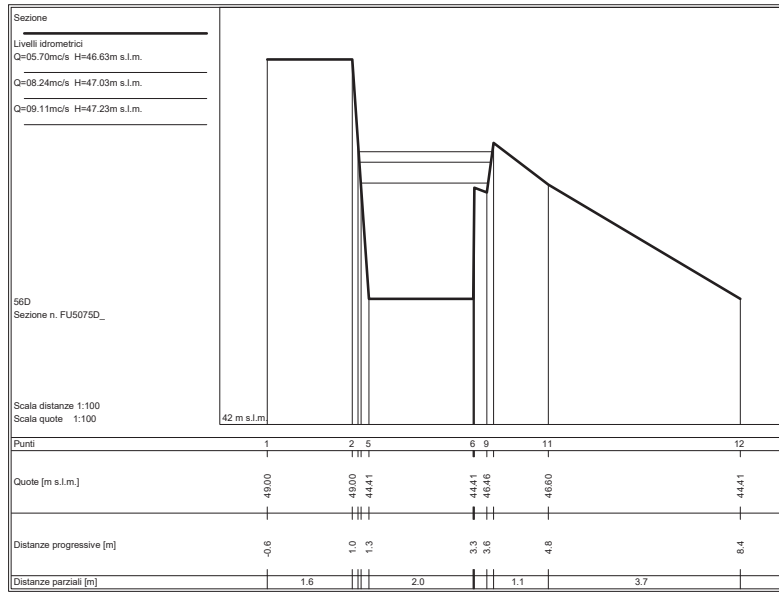

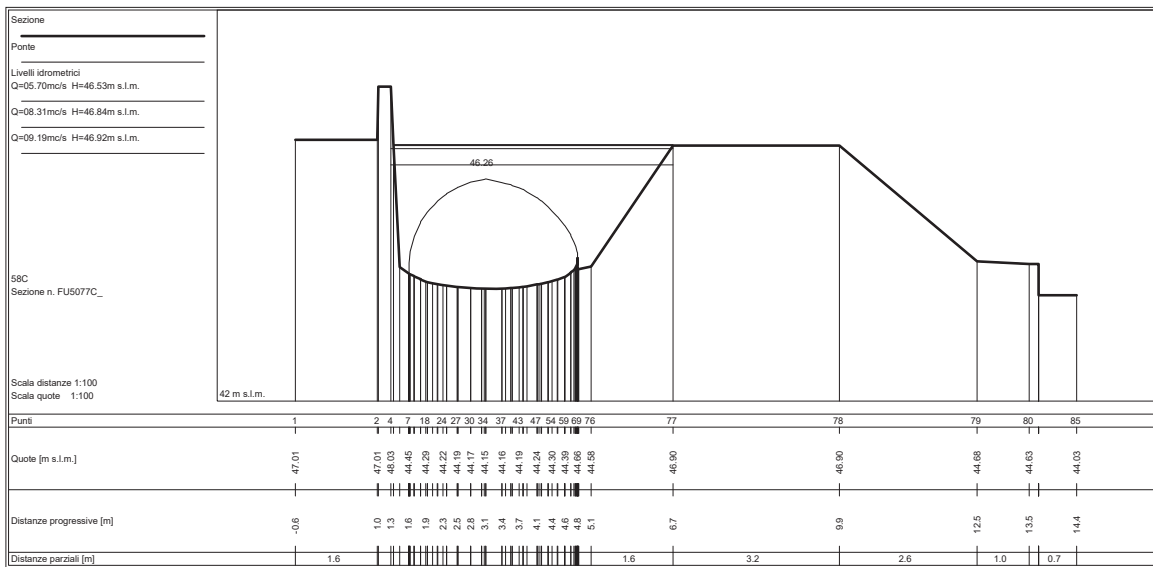
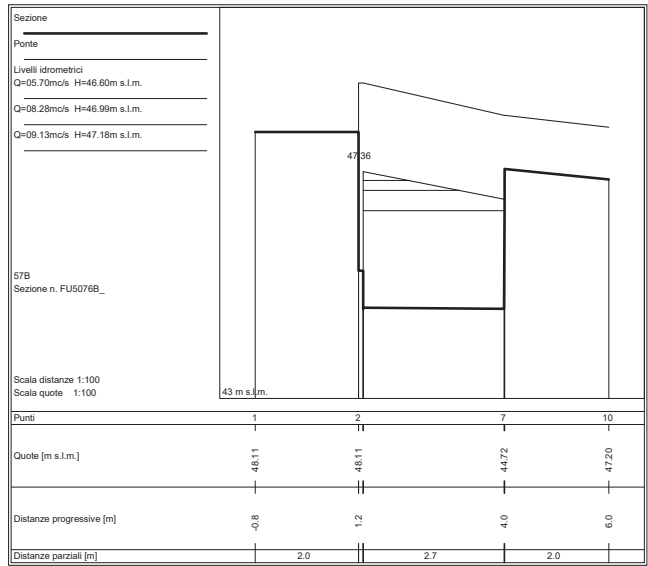

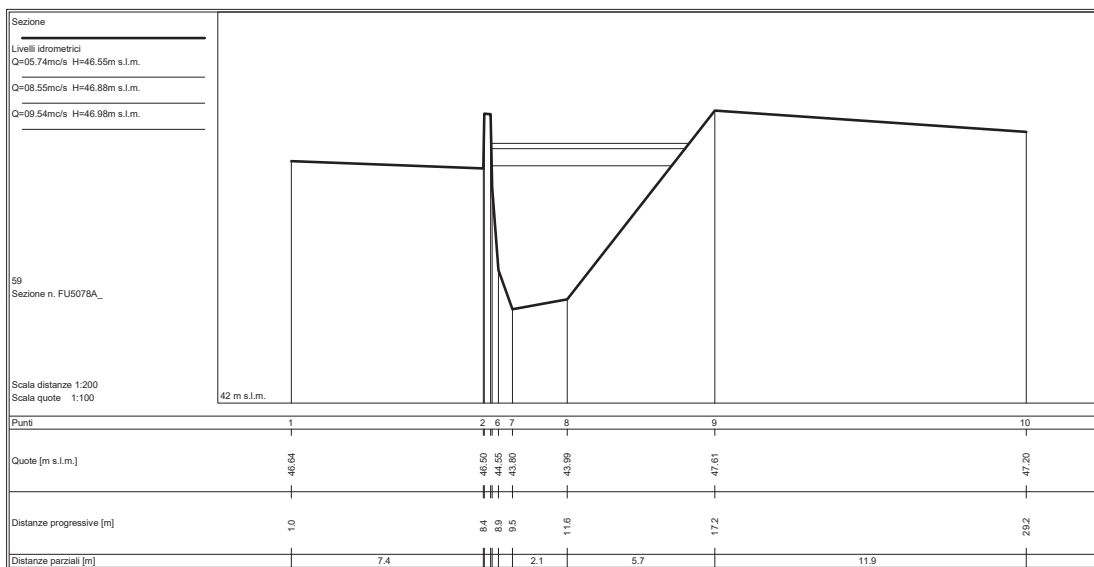
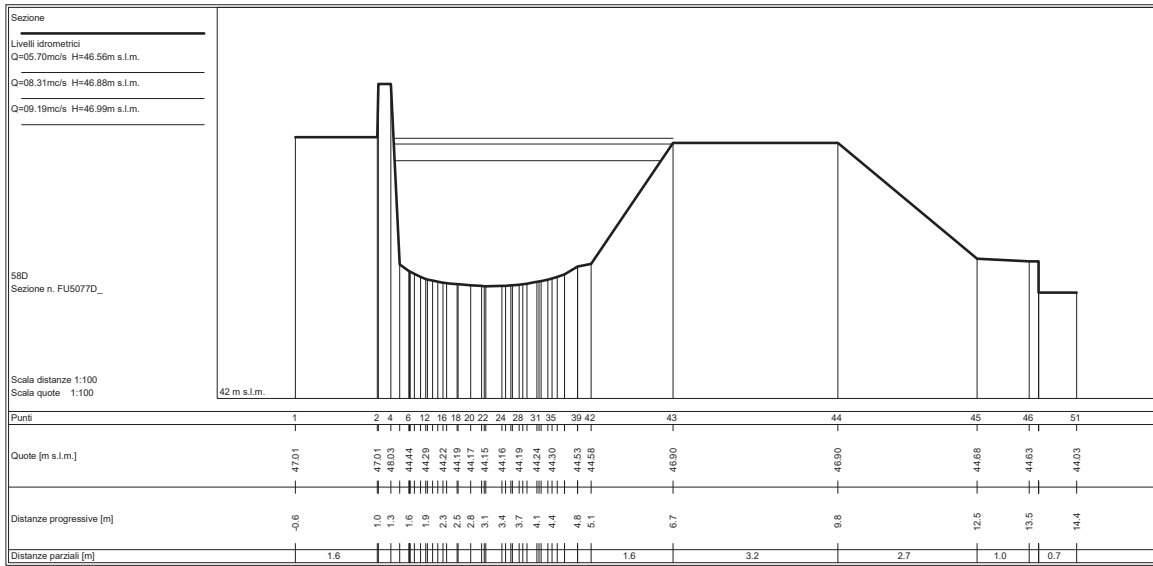

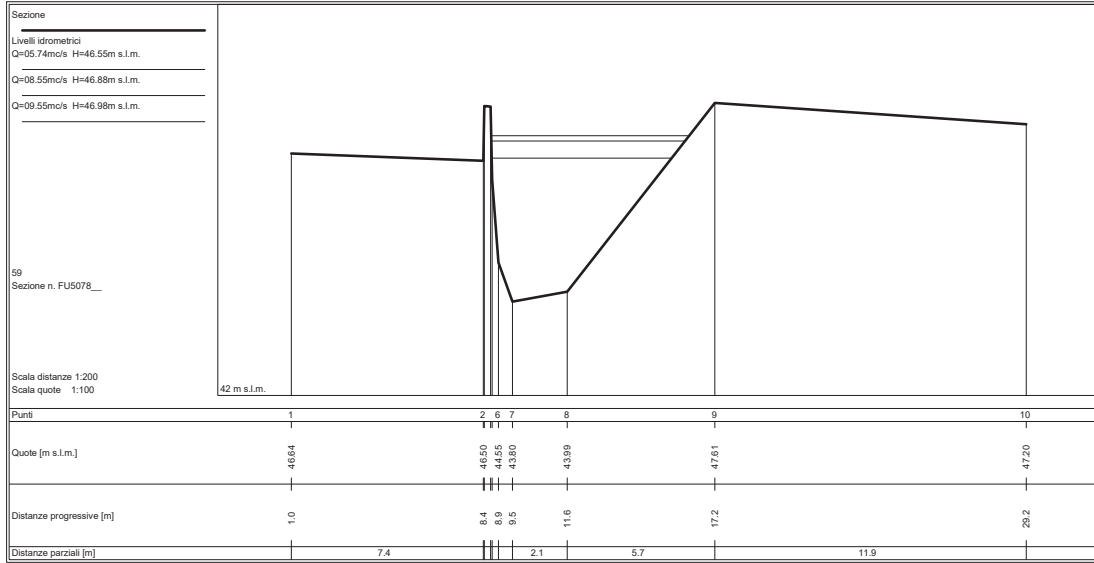

SEZIONI FLUVIALI  
FOSSO FUNANDOLA - TRATTO DV

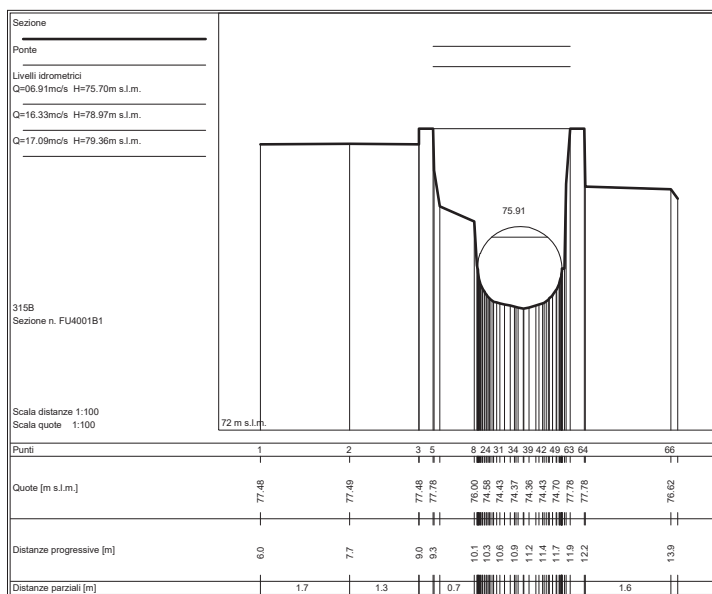
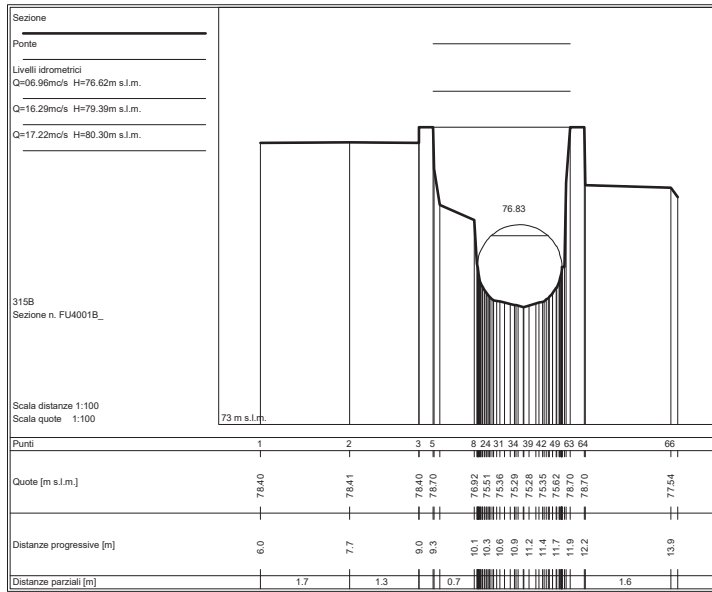

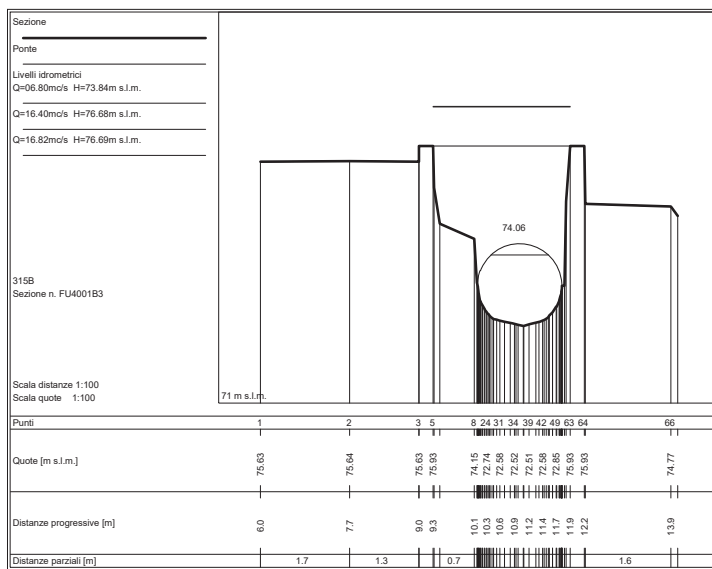
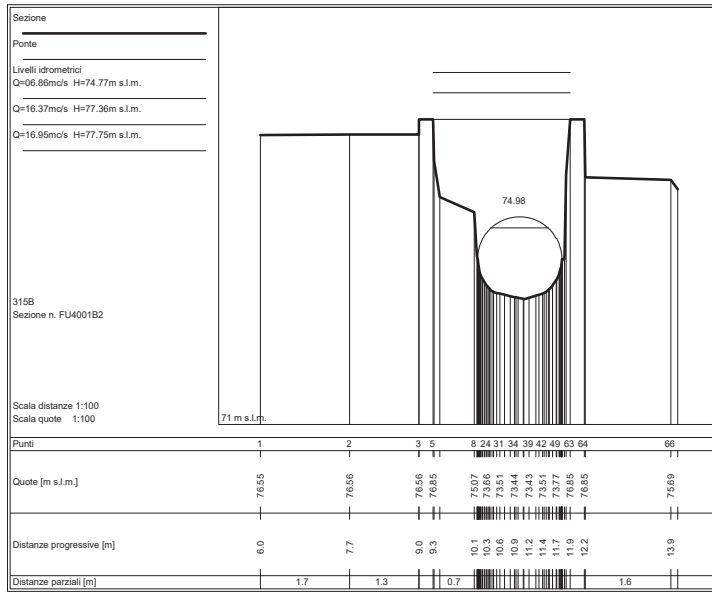



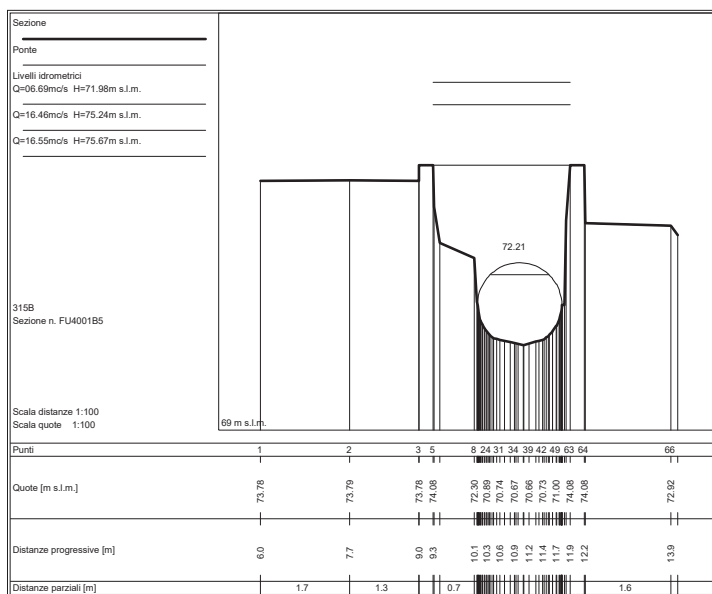
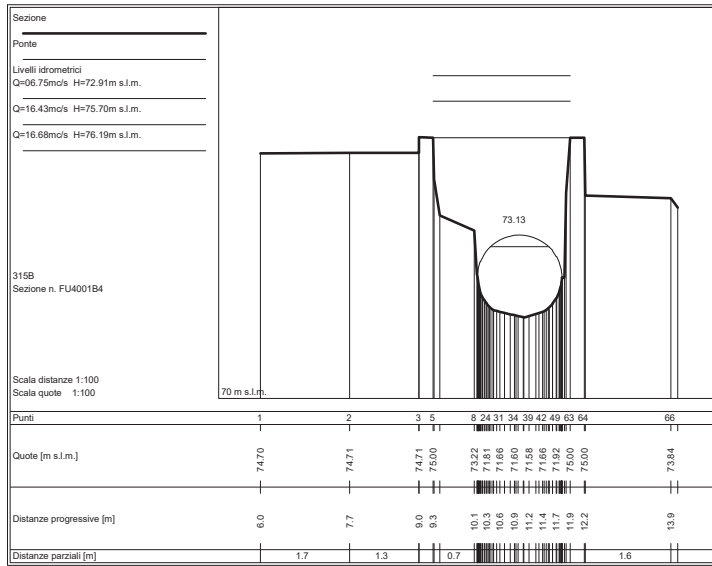

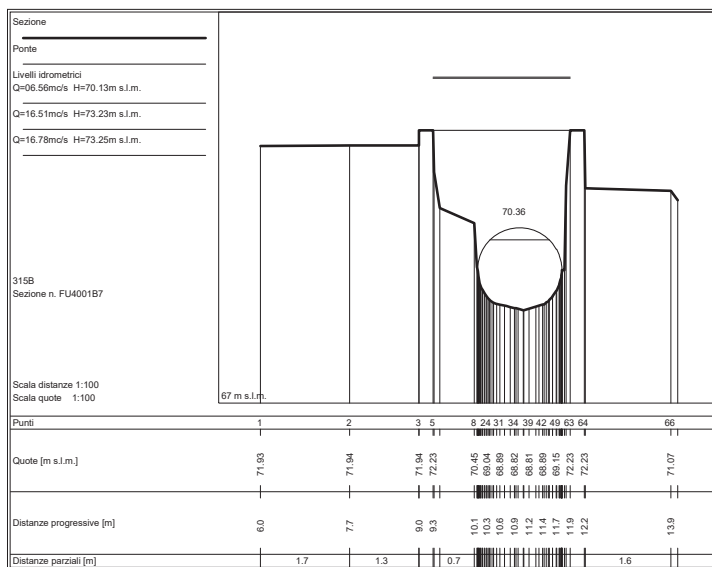
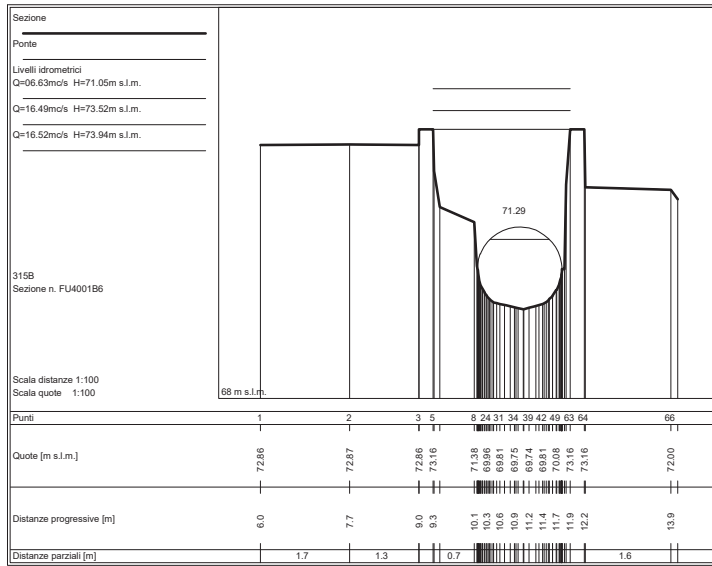

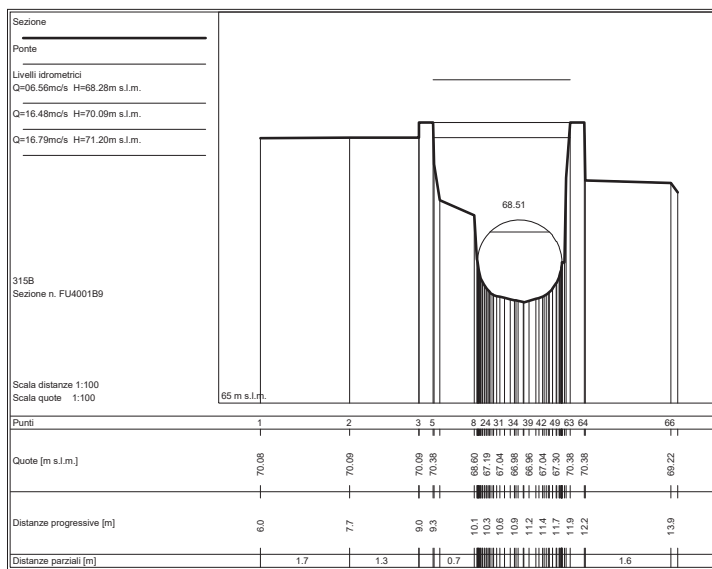
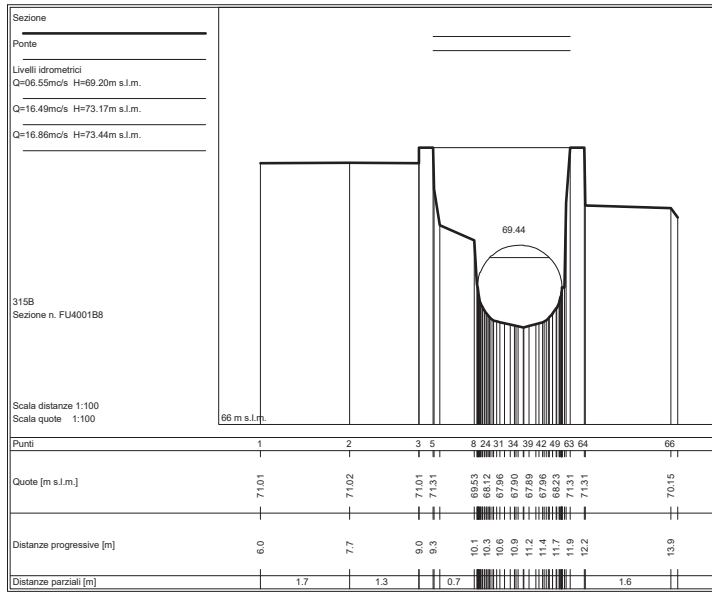

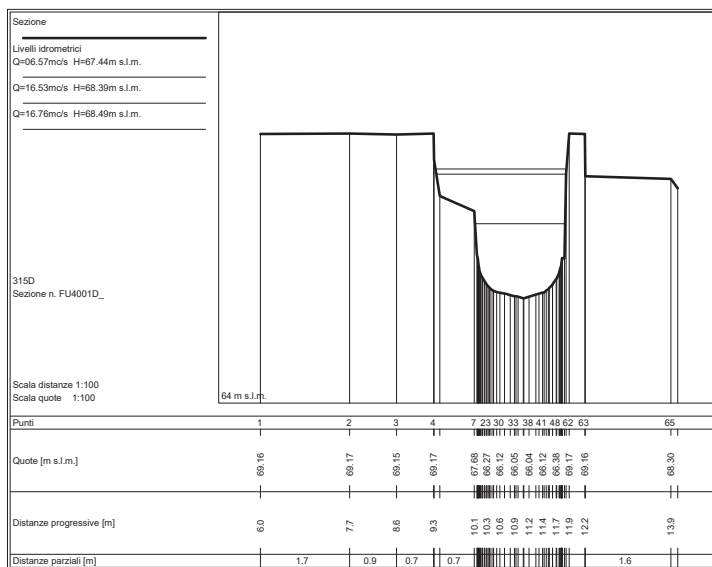
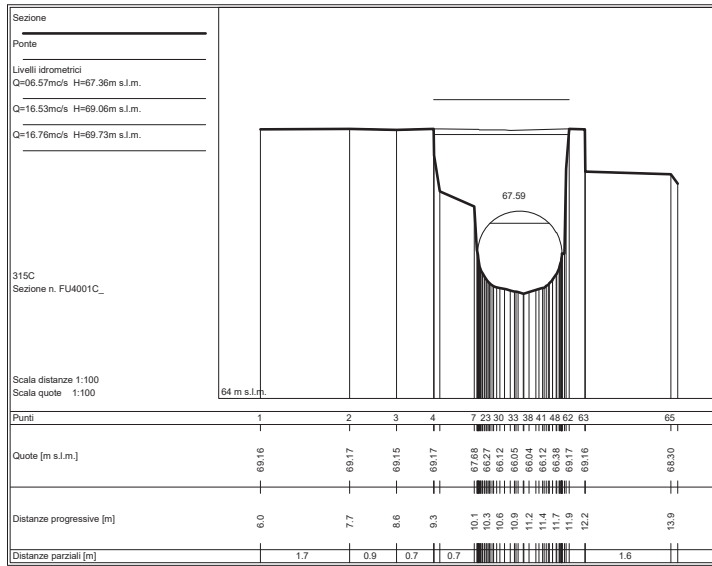

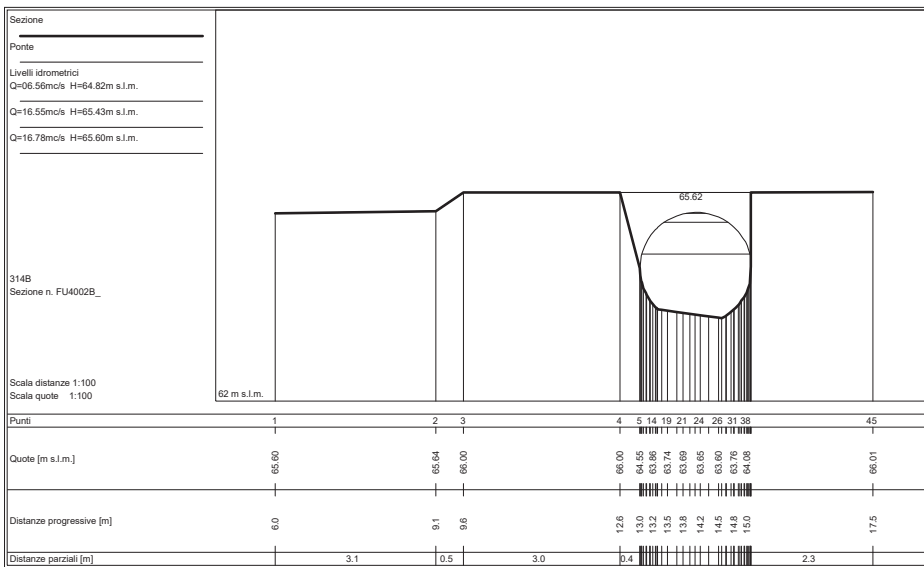
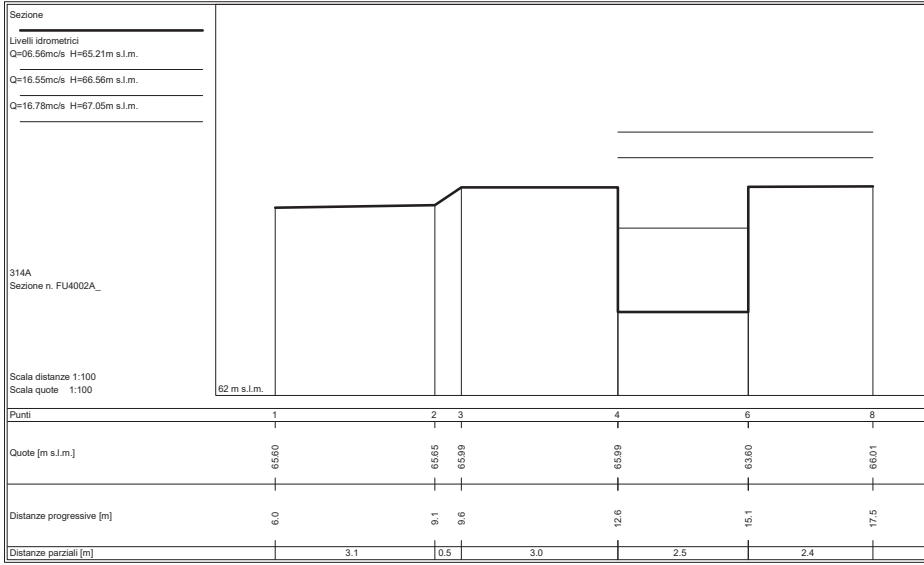

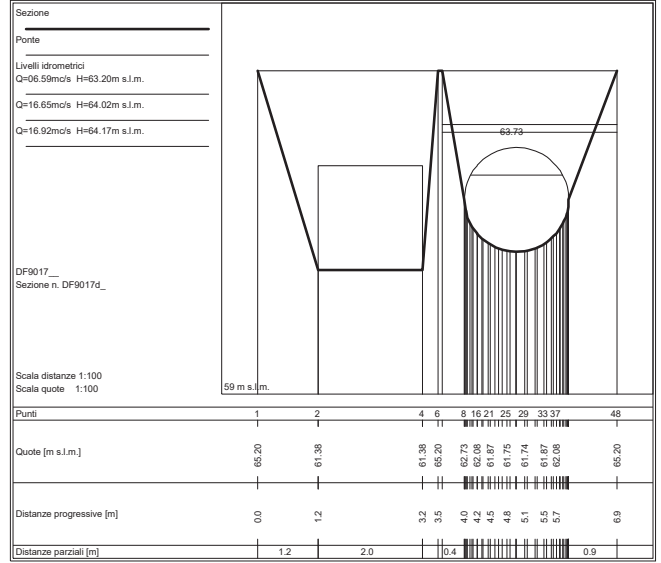
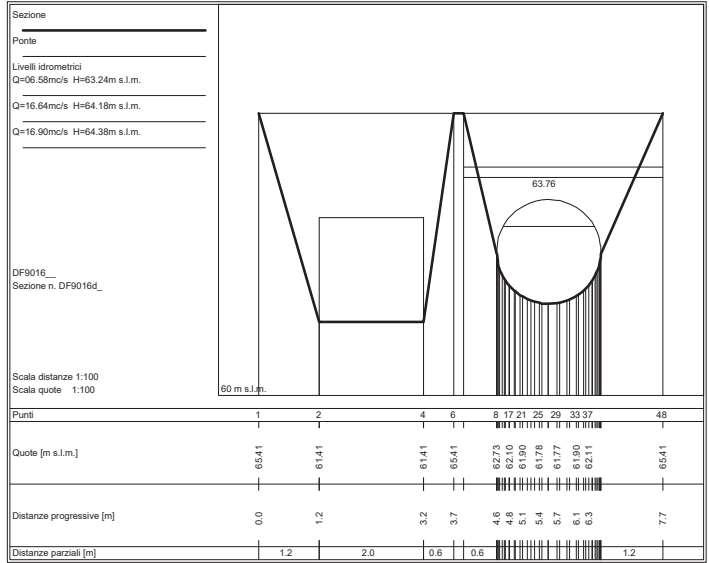

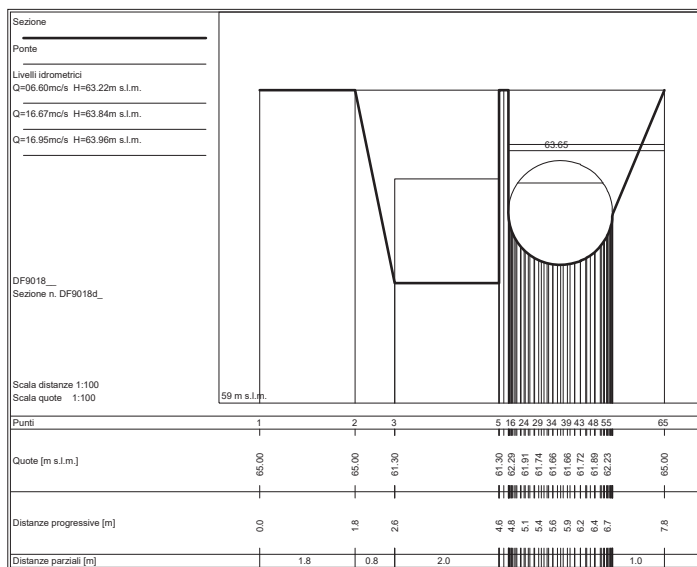
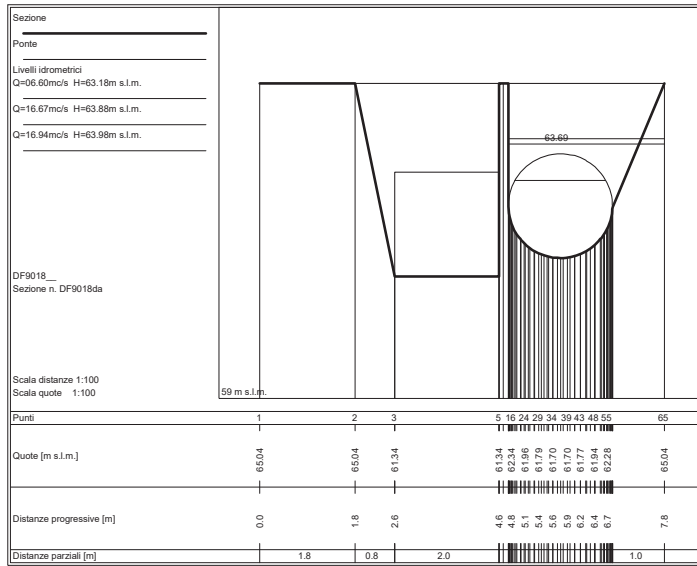

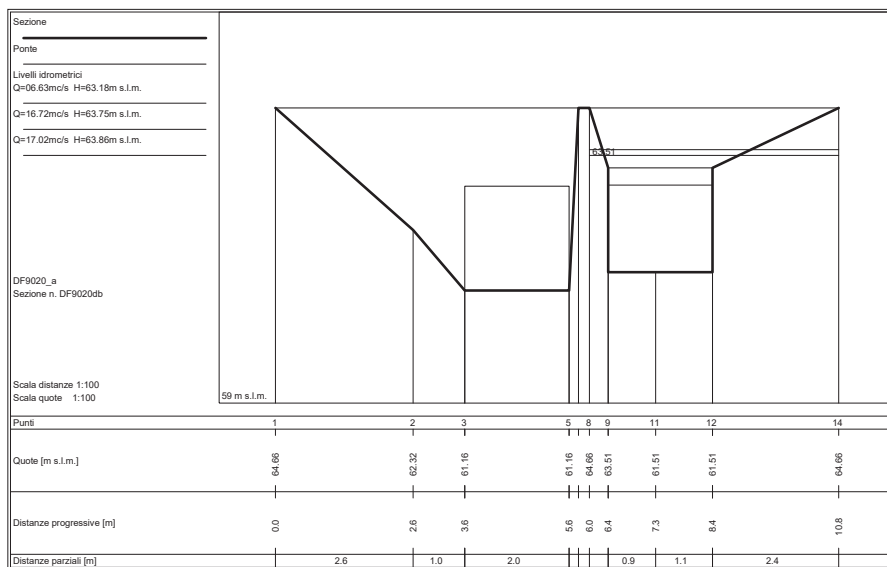
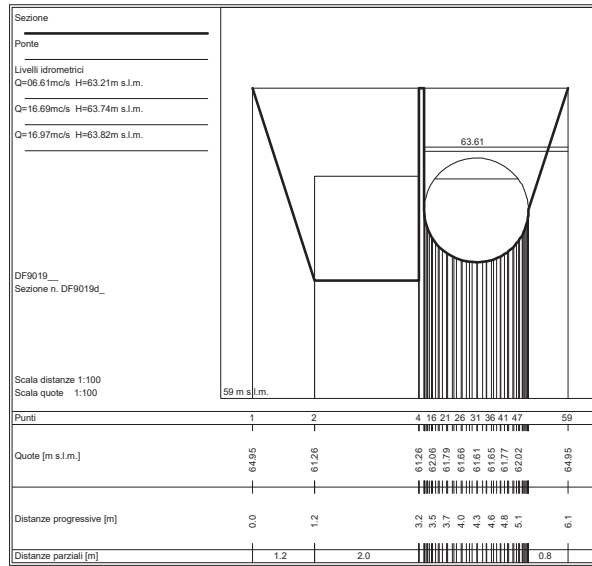



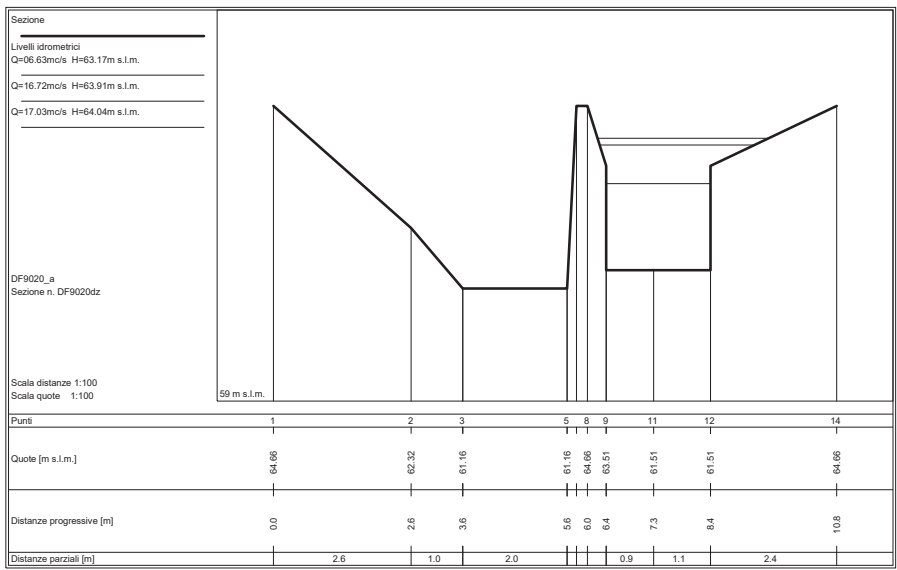
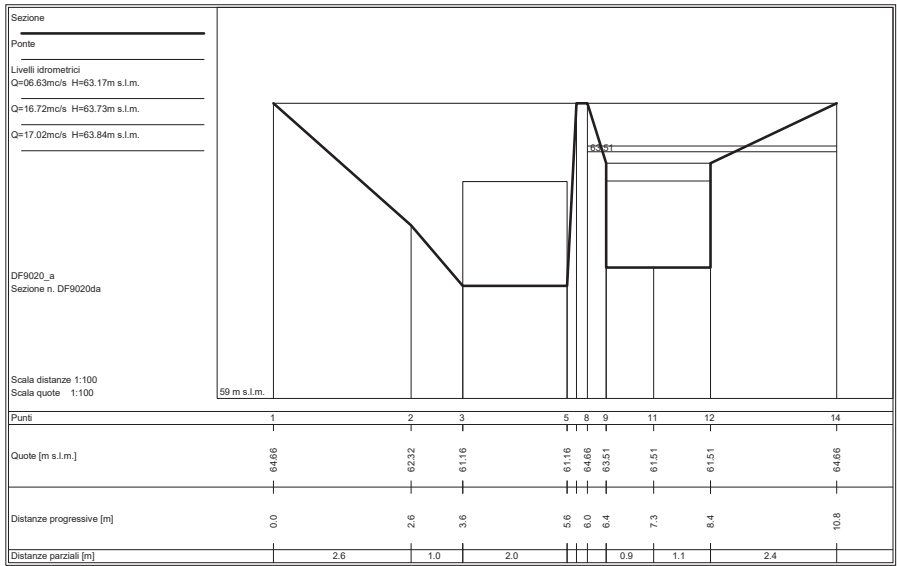

SEZIONI FLUVIALI  
FOSSO GRAMIGNETO

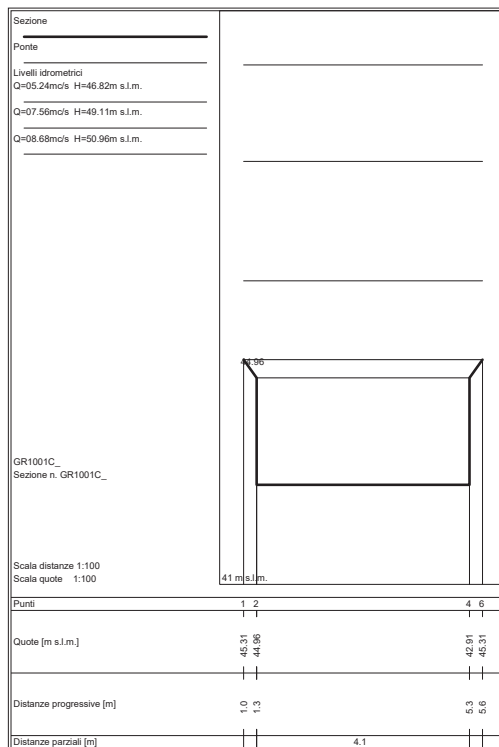
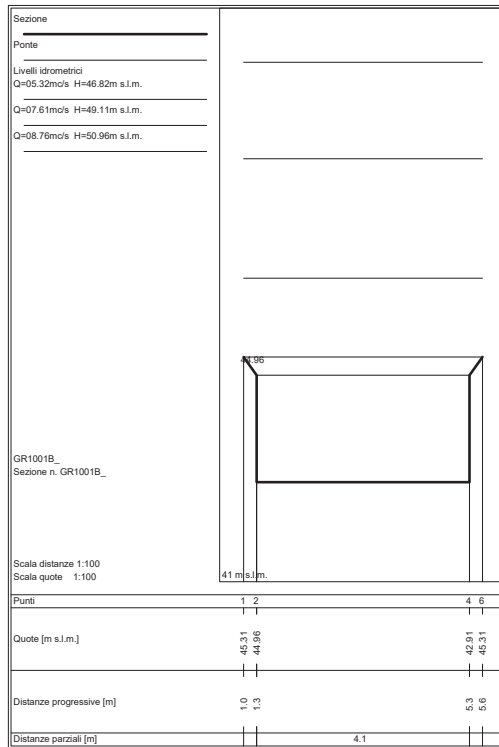

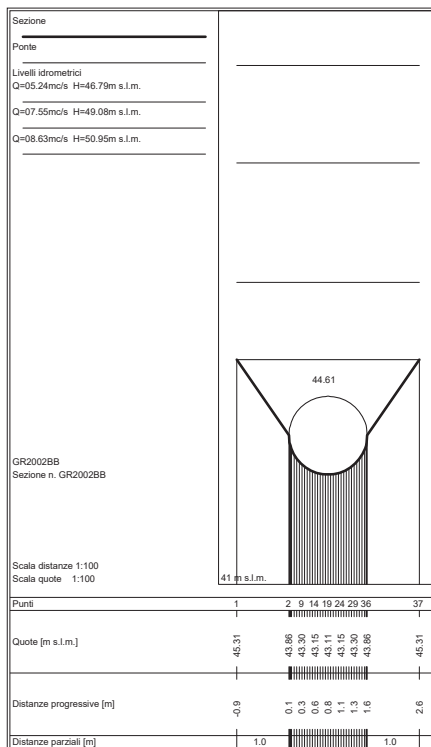
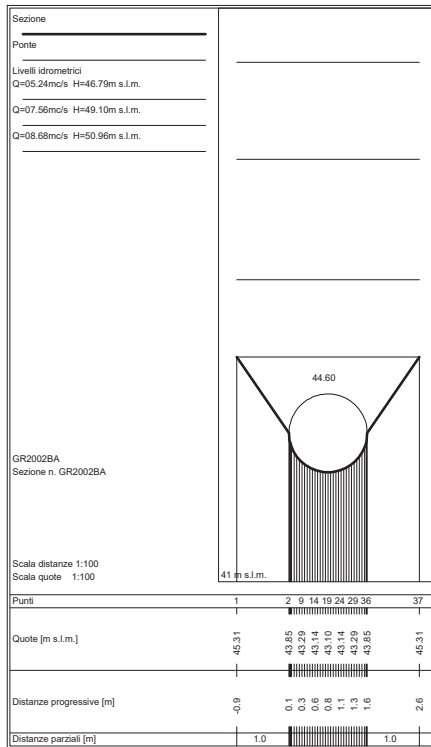

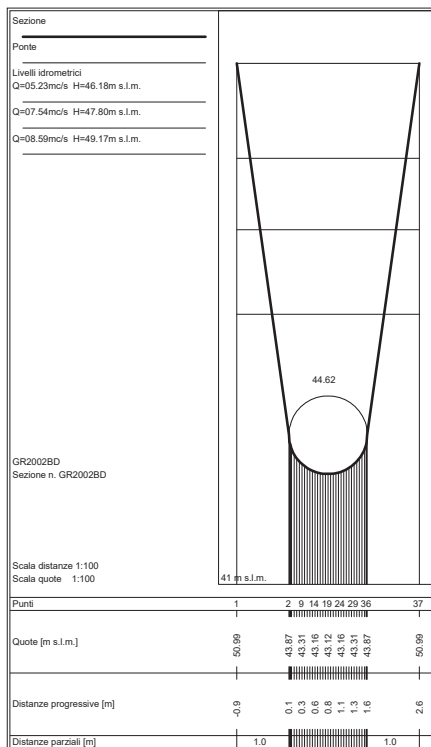
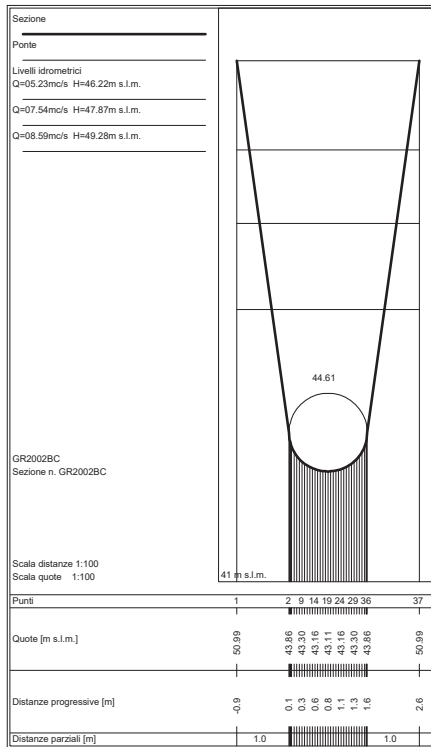

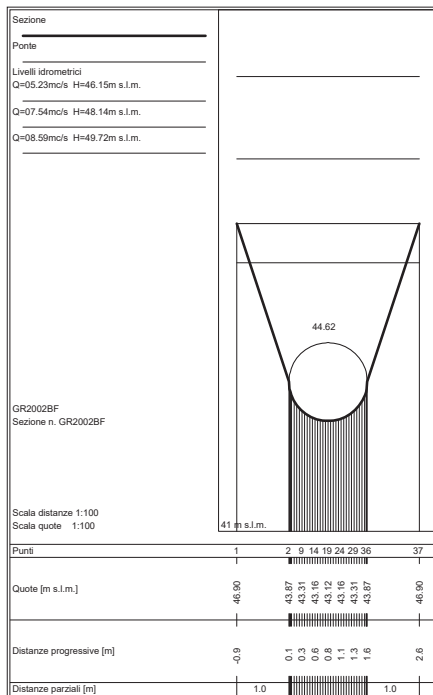
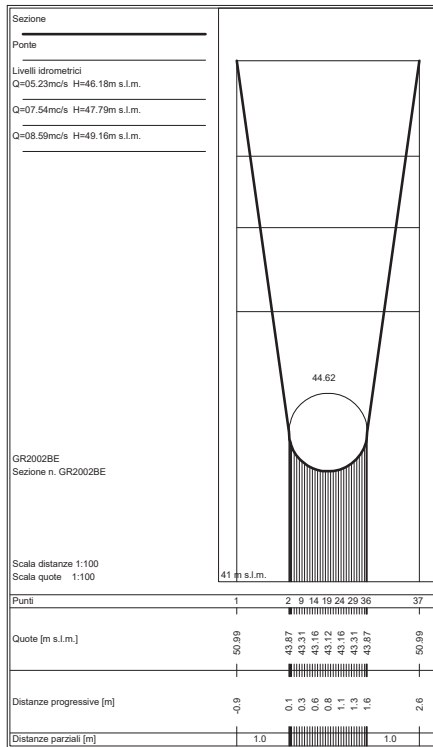

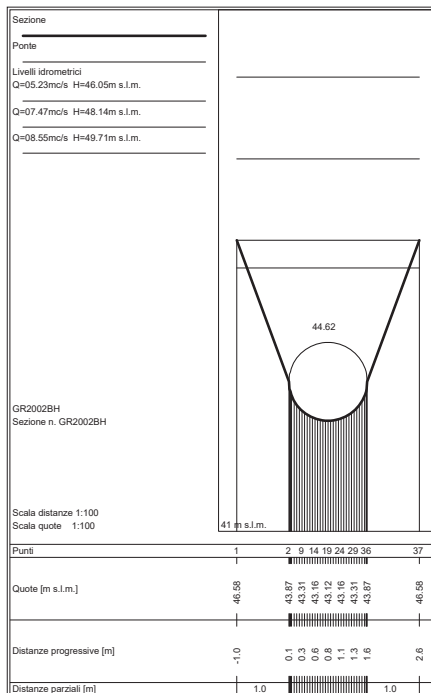
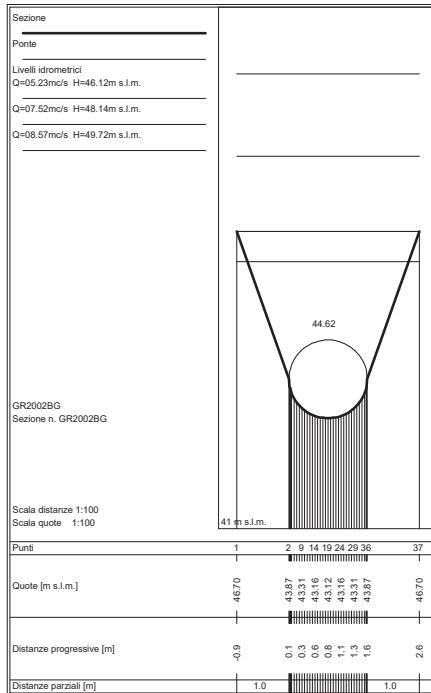

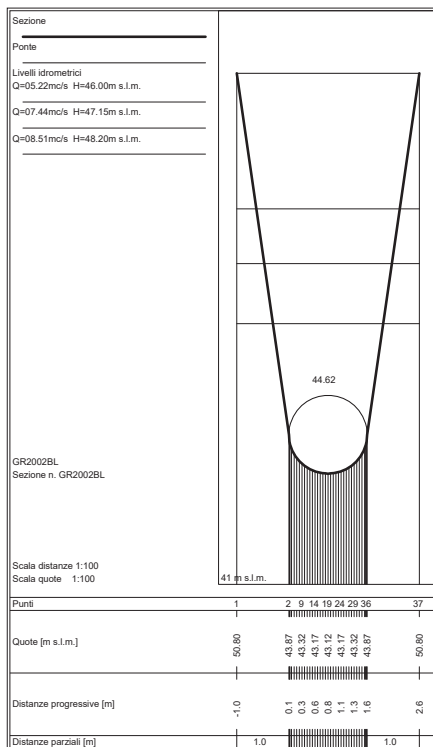
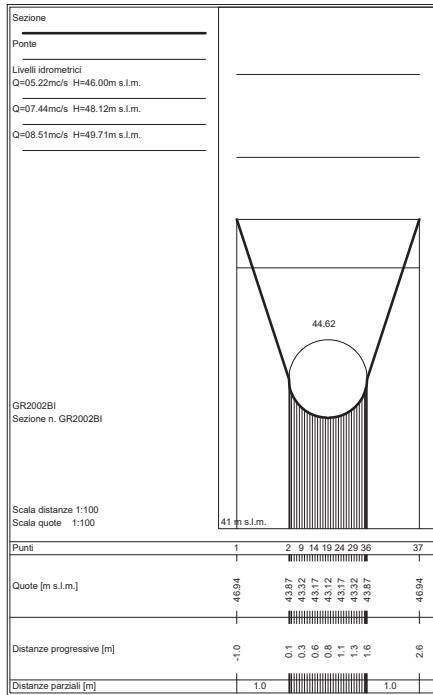



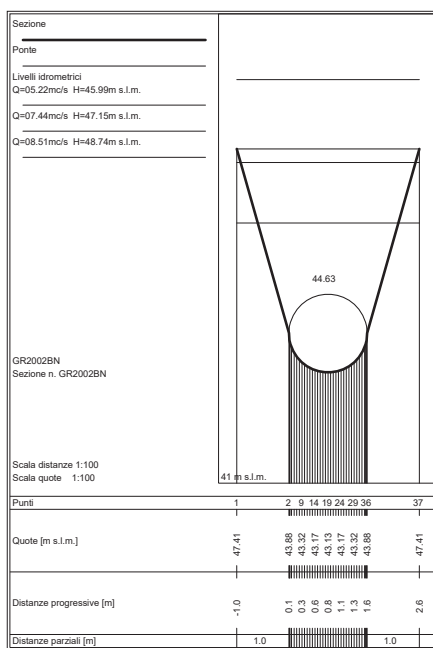
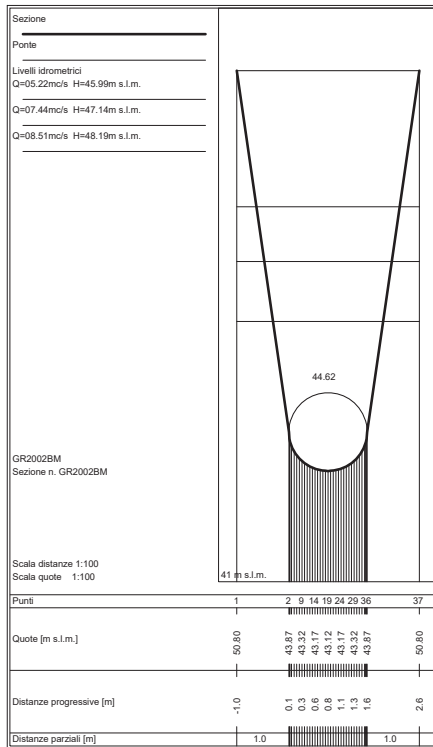

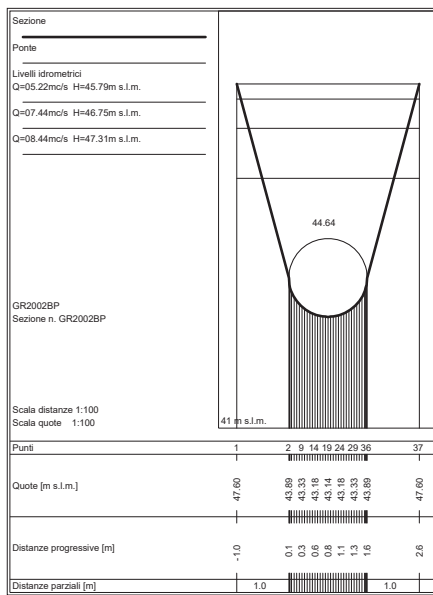
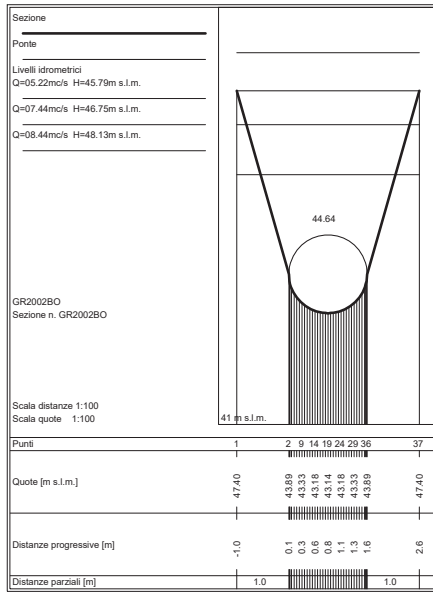

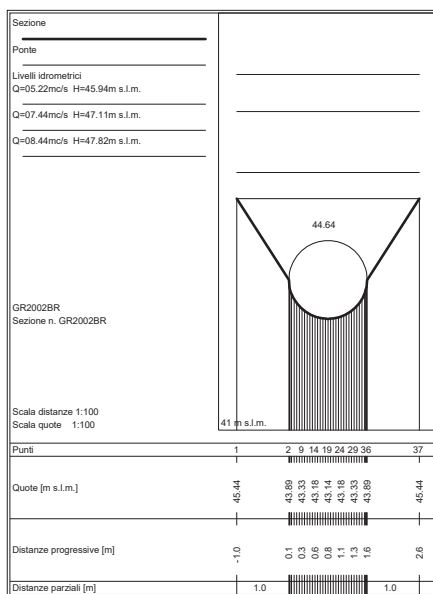
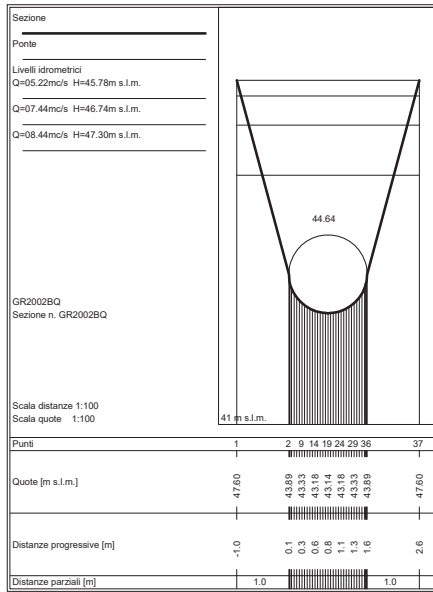

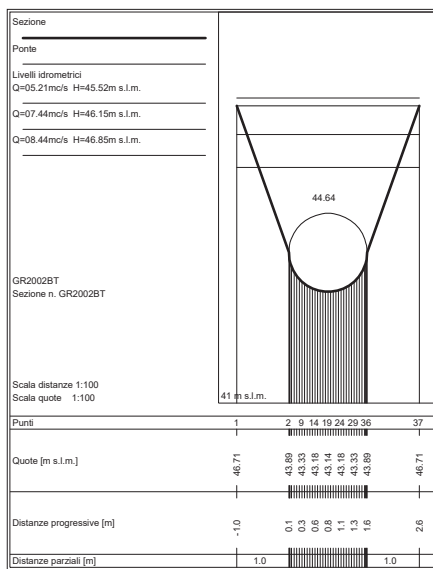
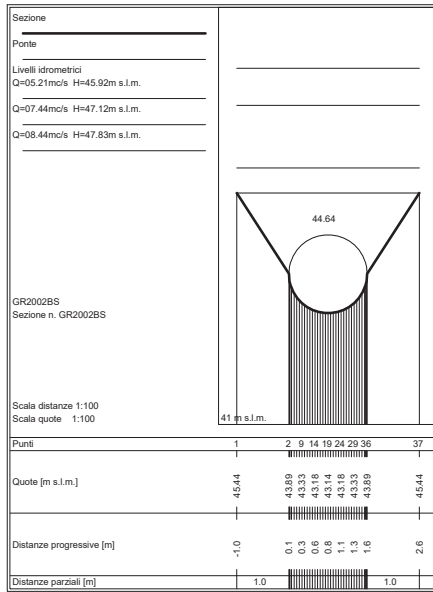

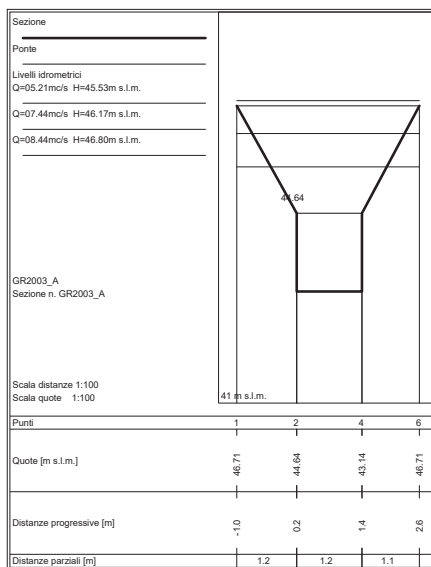
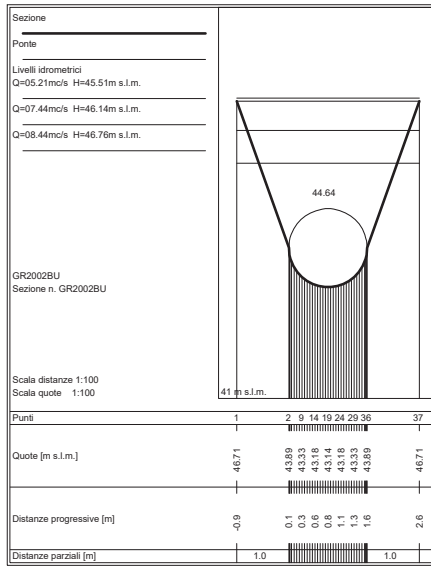

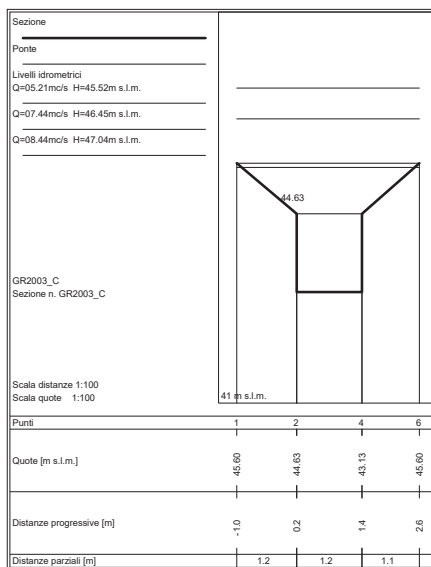
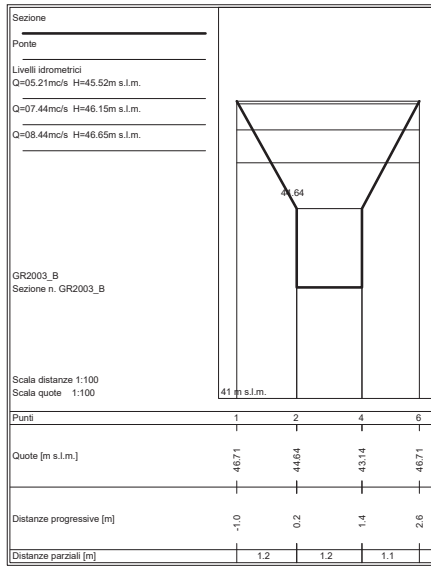

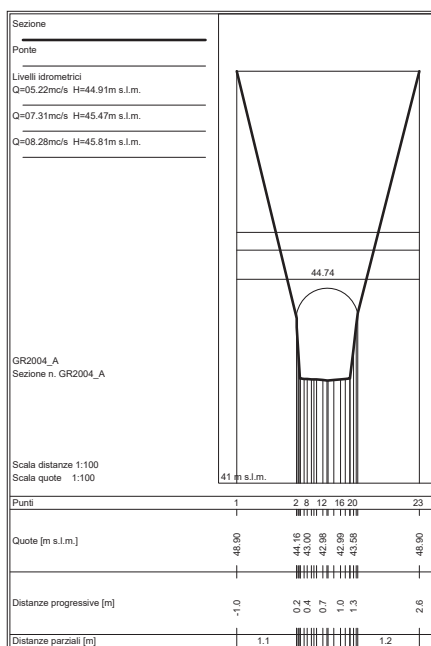
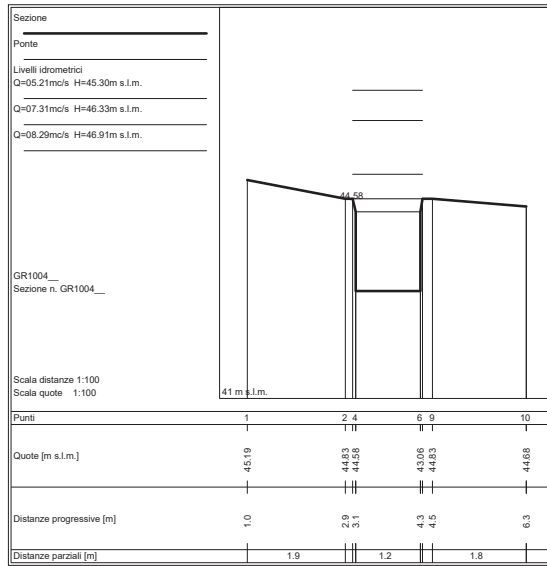

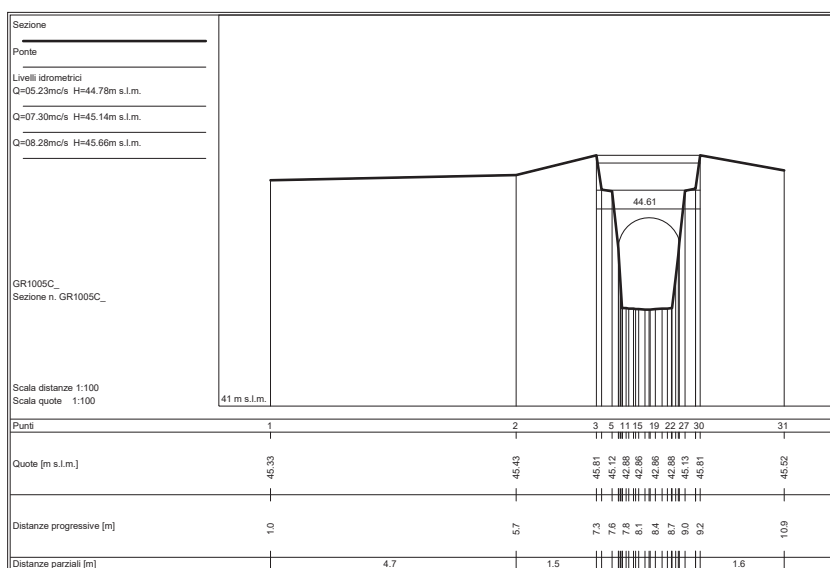
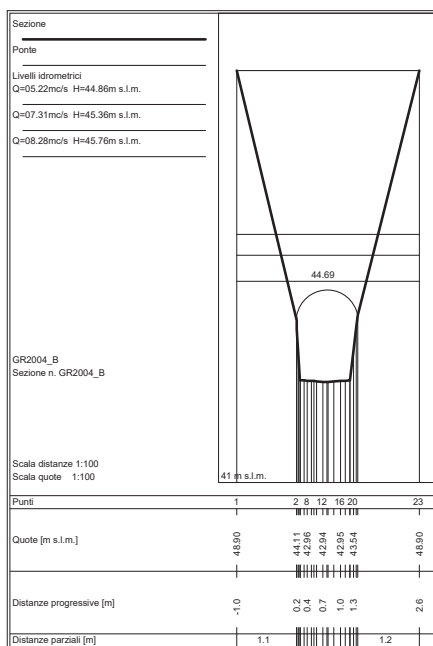



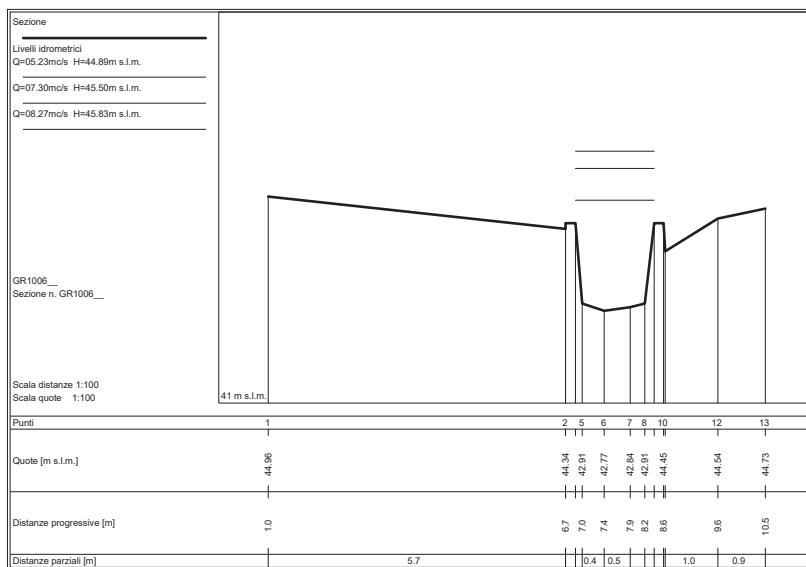
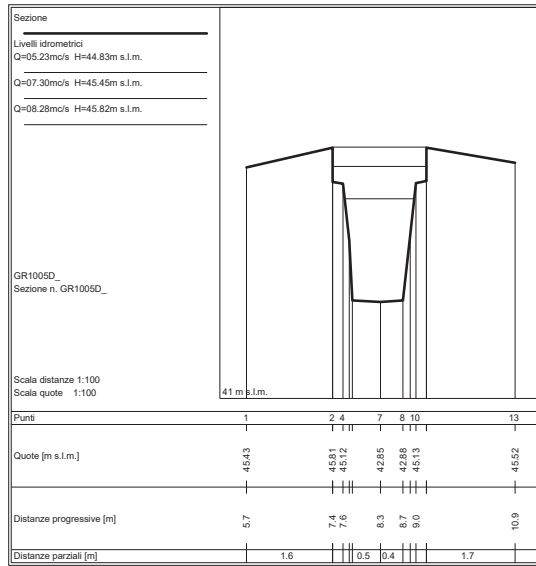

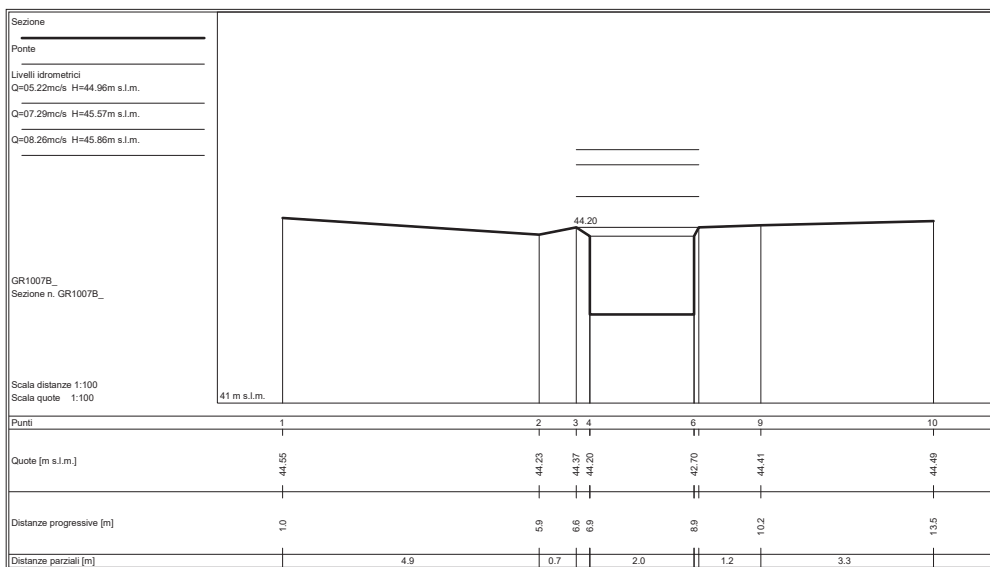
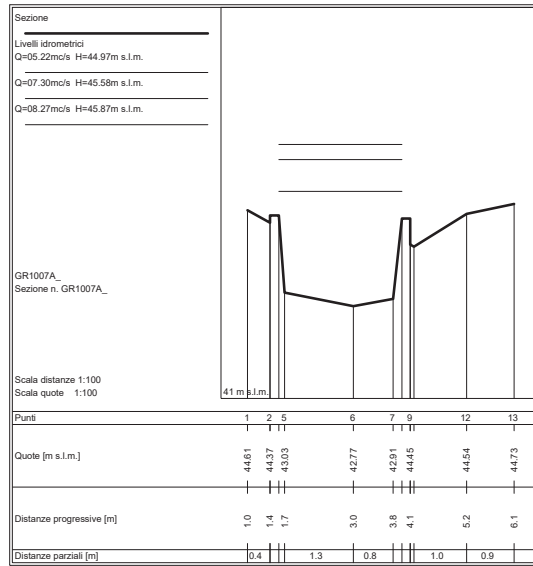

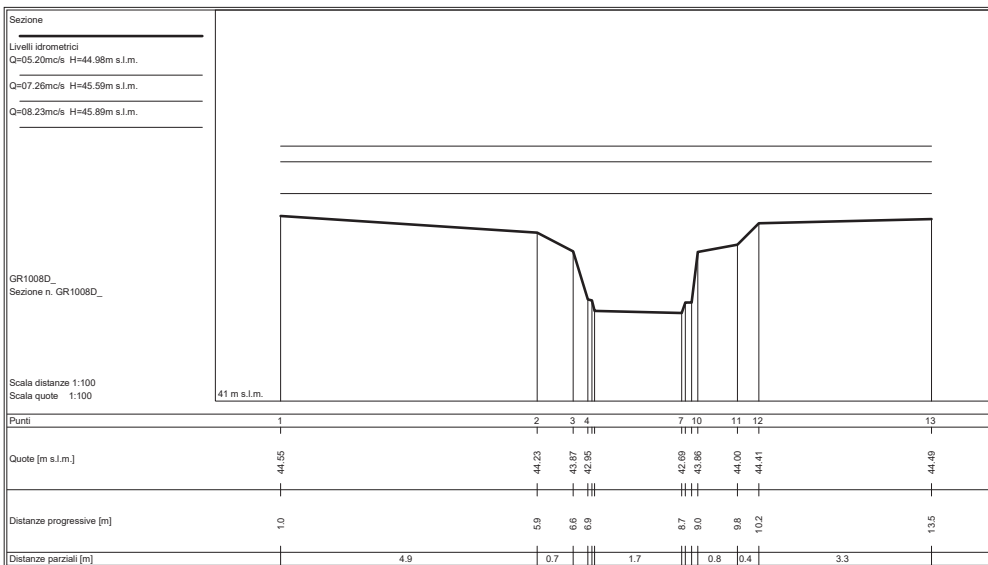
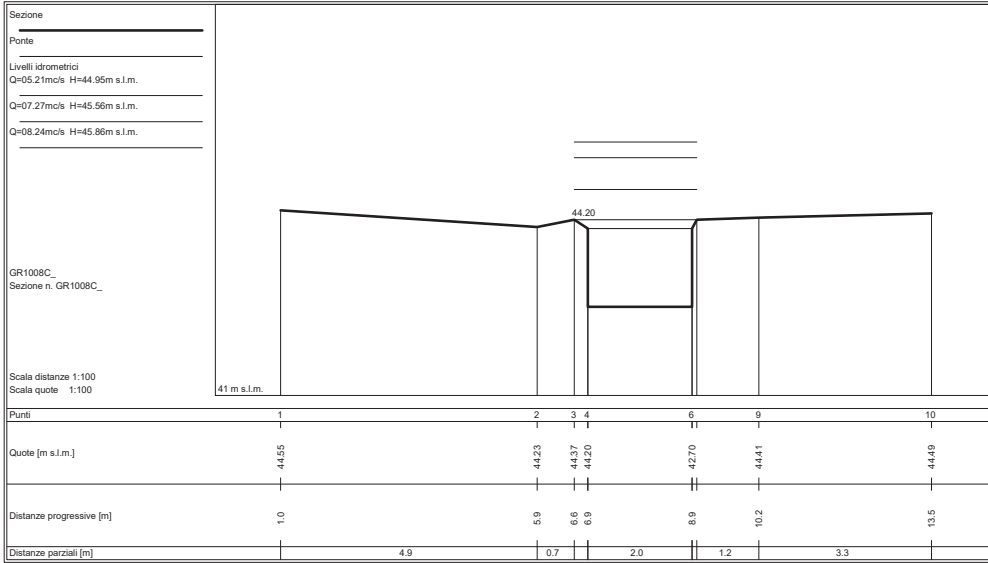

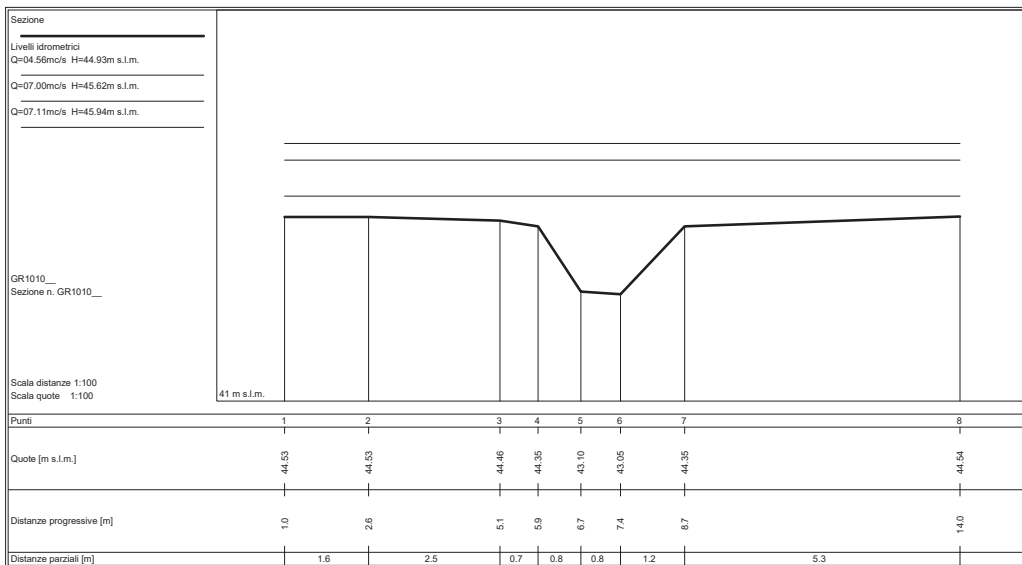
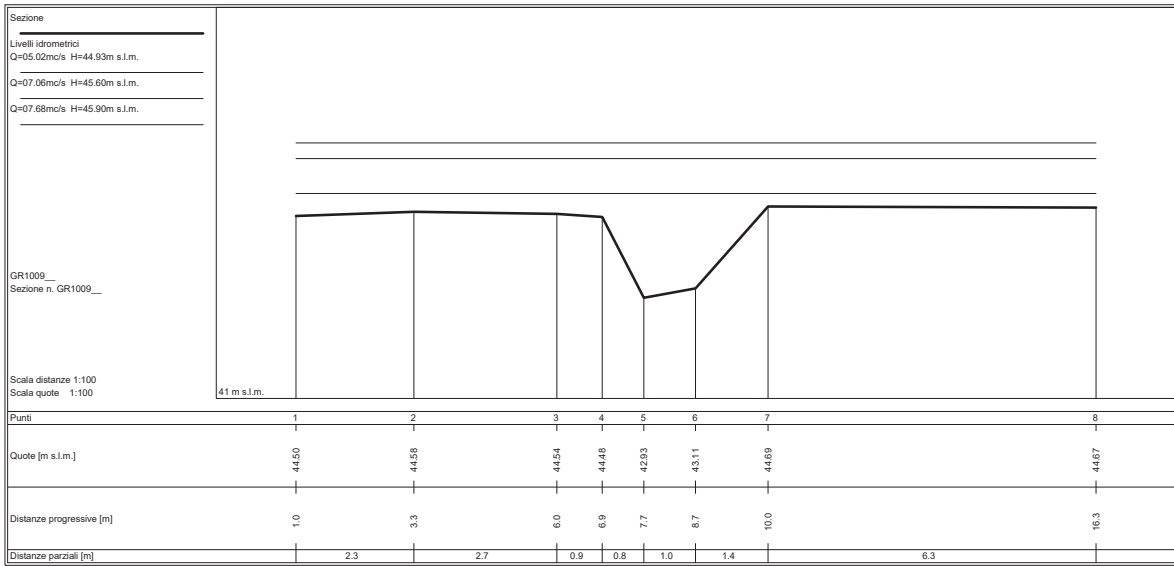

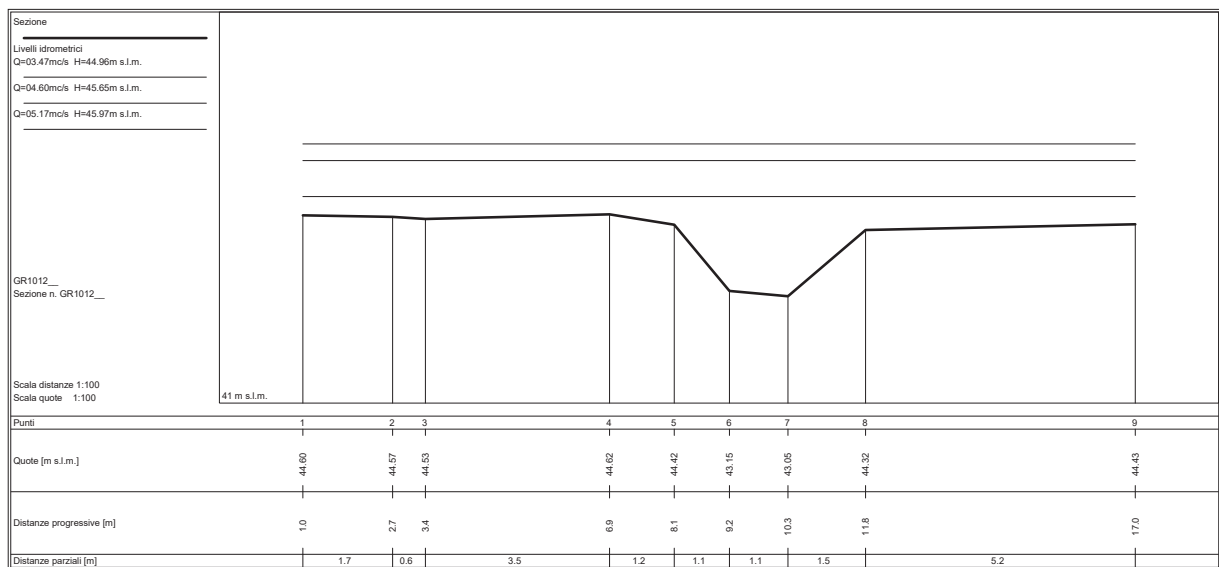
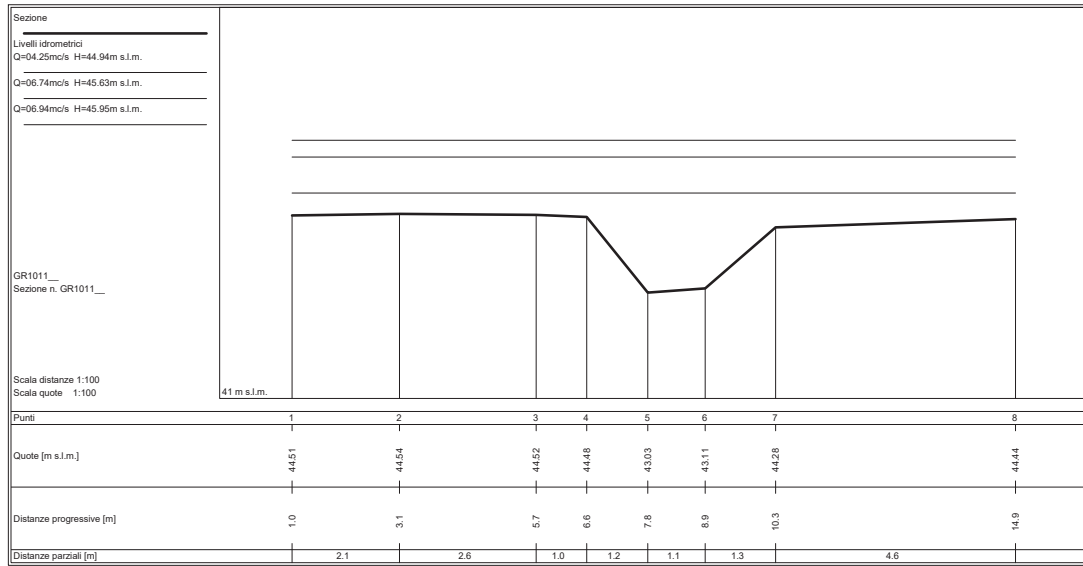

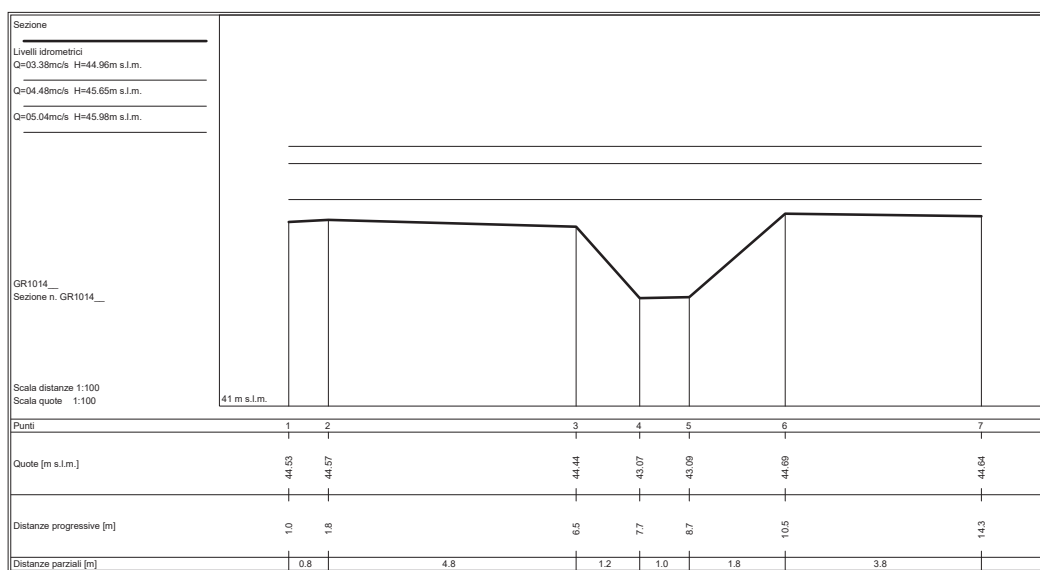
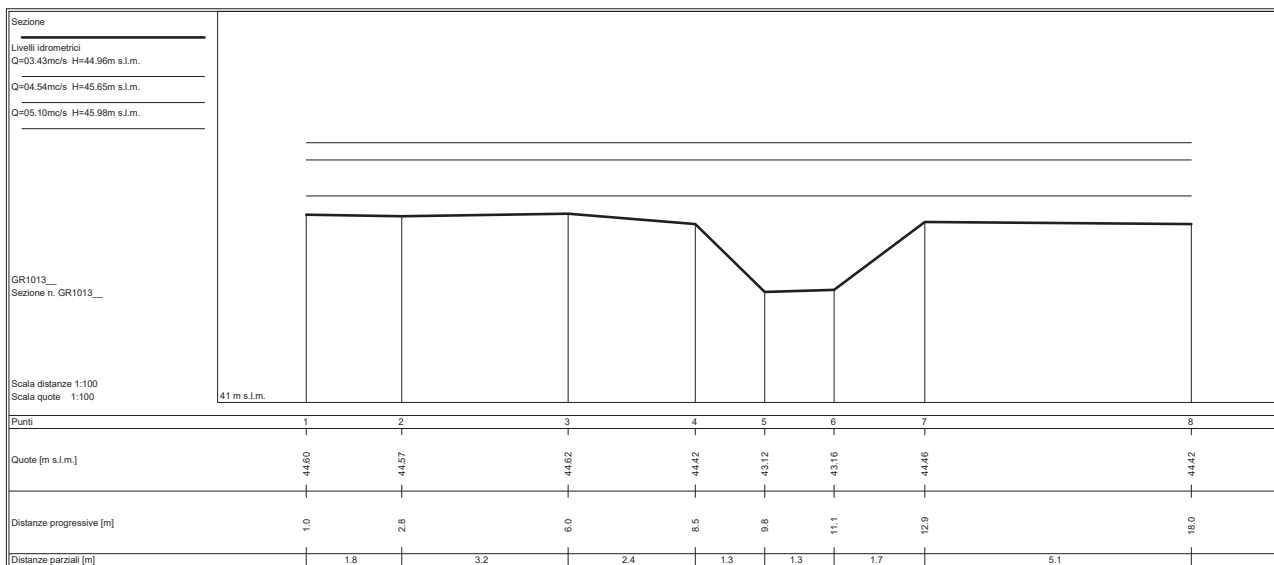

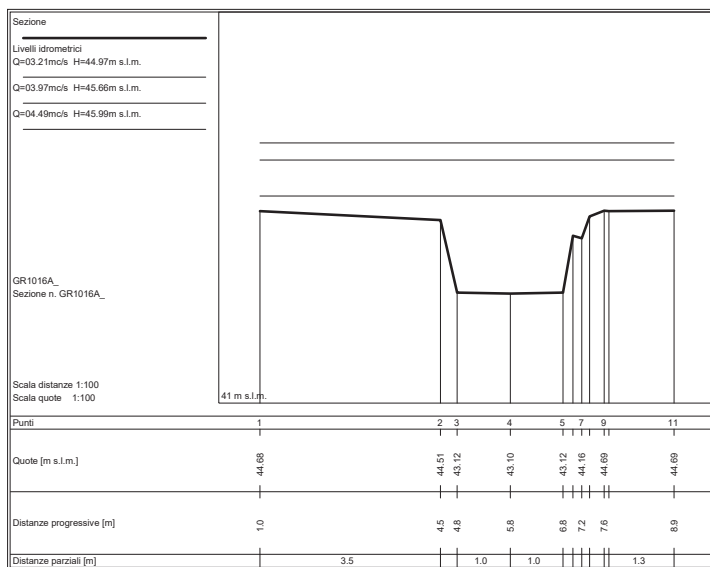
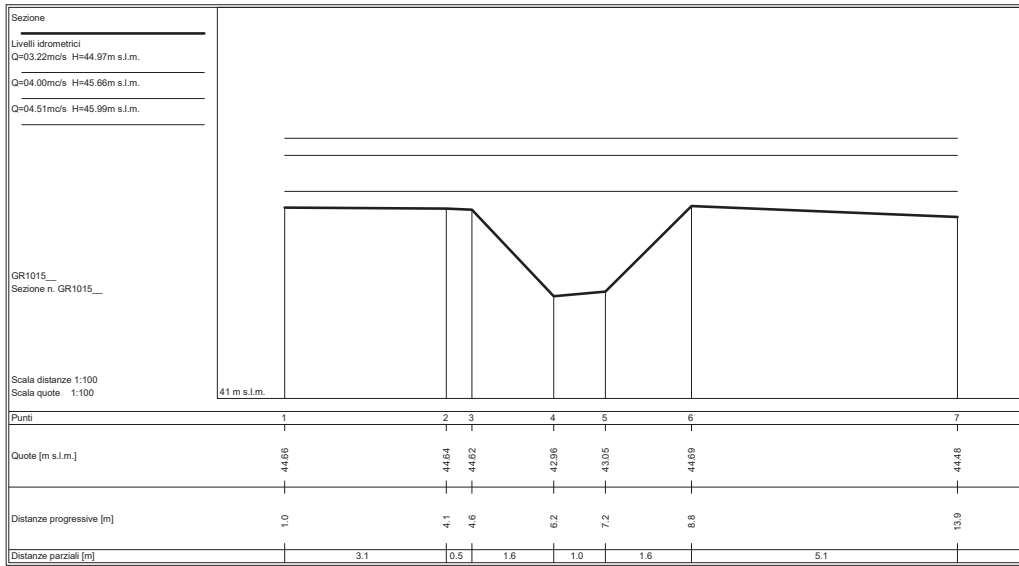

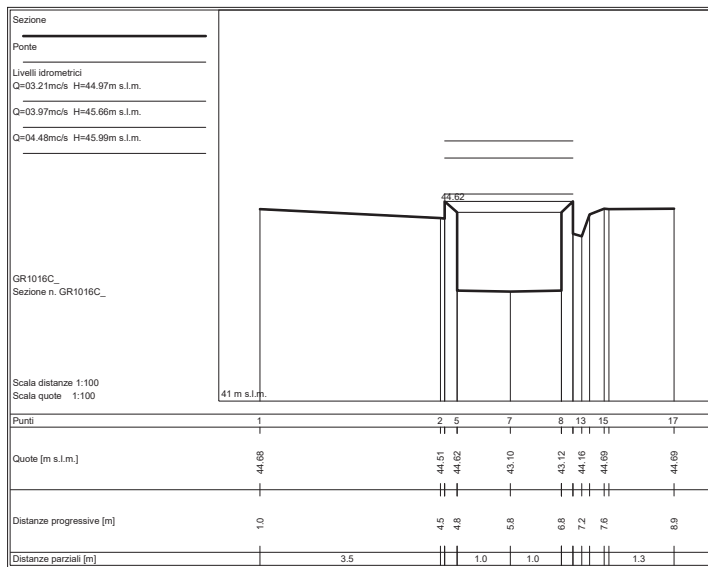
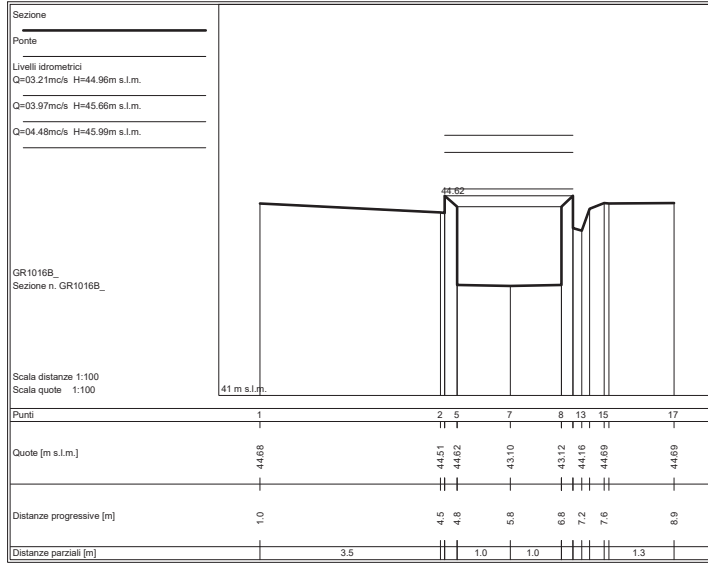



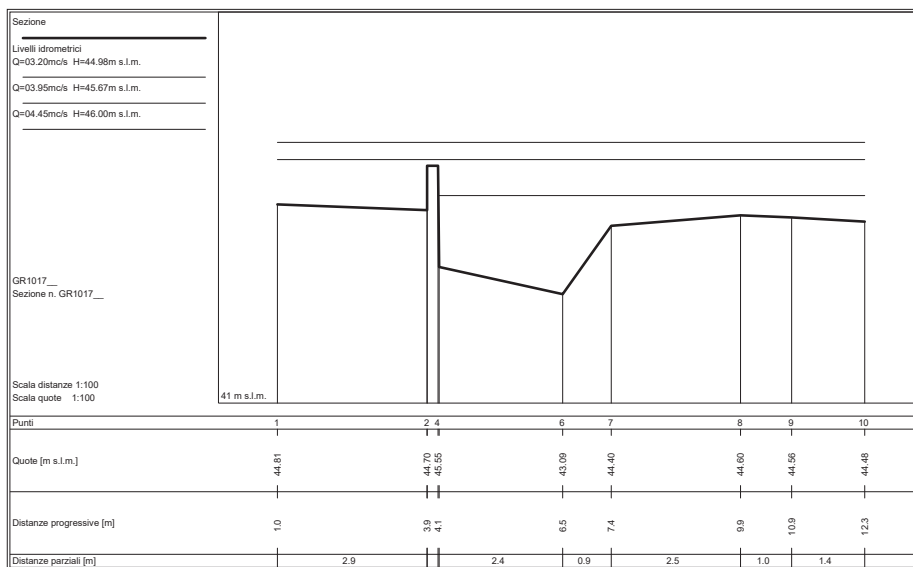
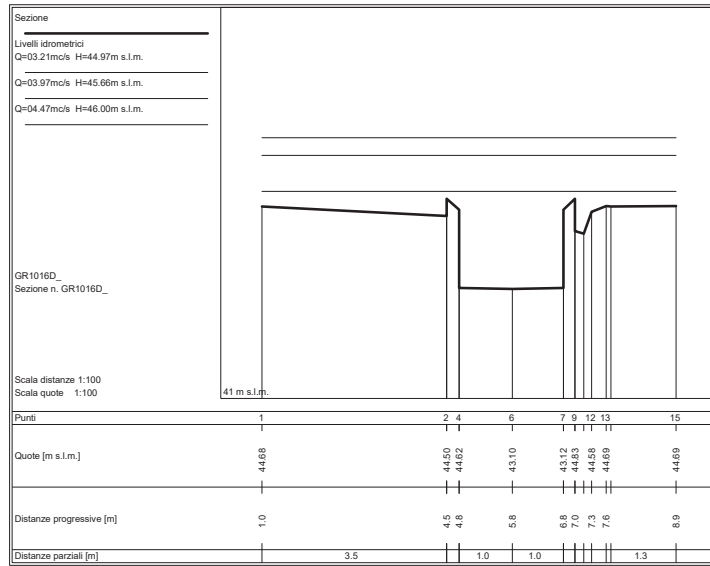

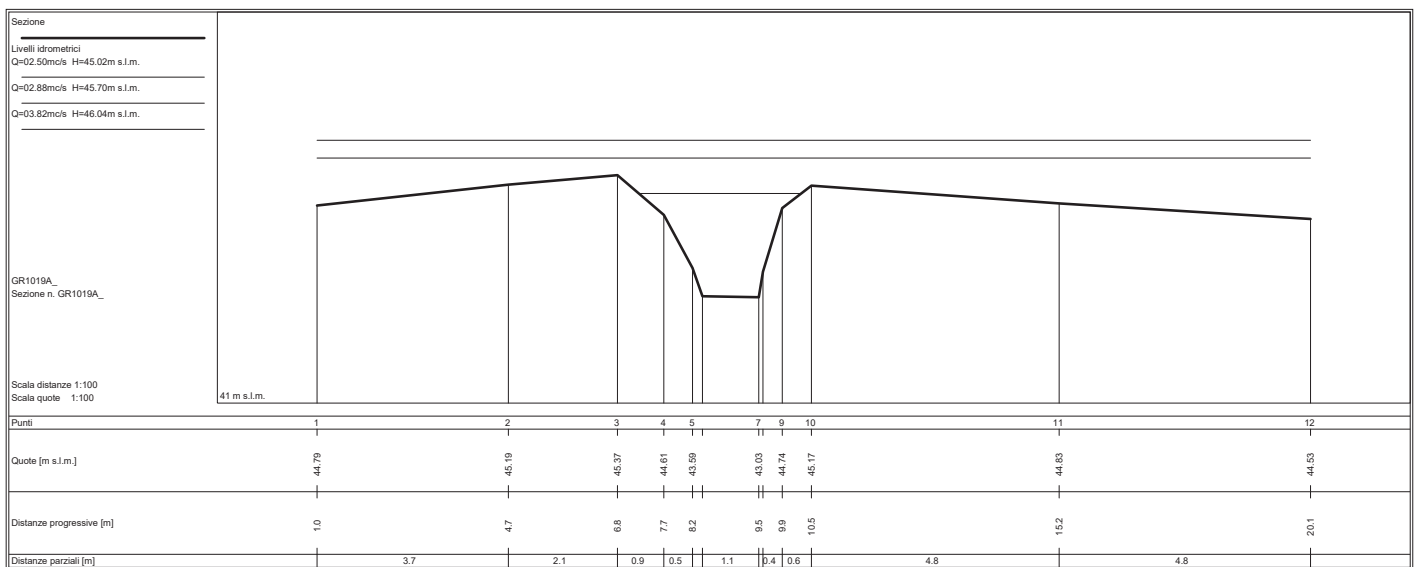
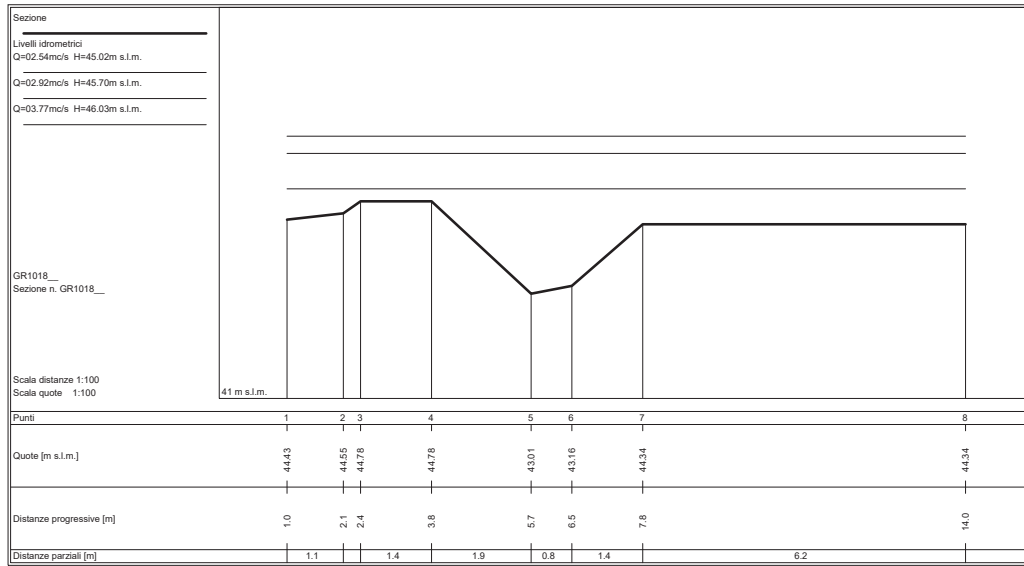

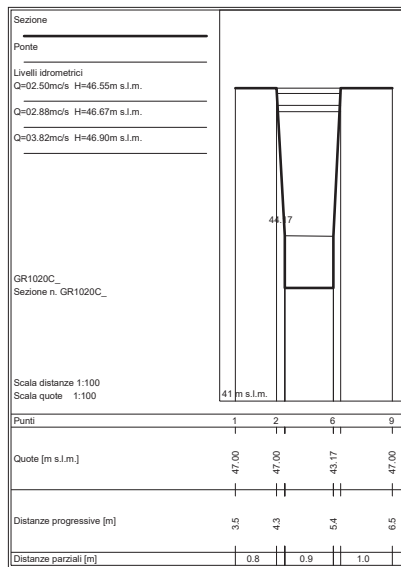
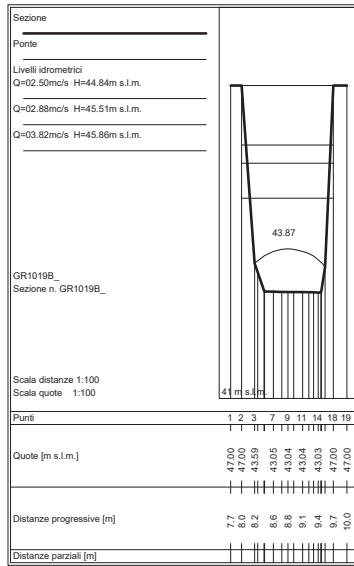

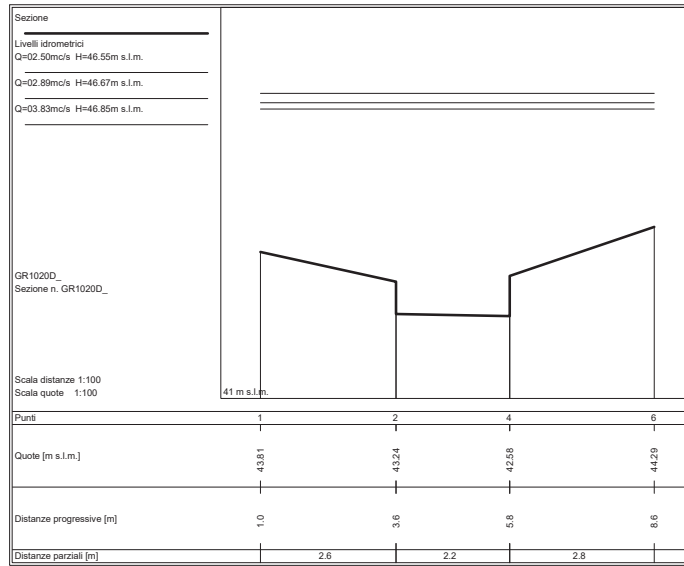

SEZIONI FLUVIALI  
FOSSO MENDACIONE - TRATTO 0

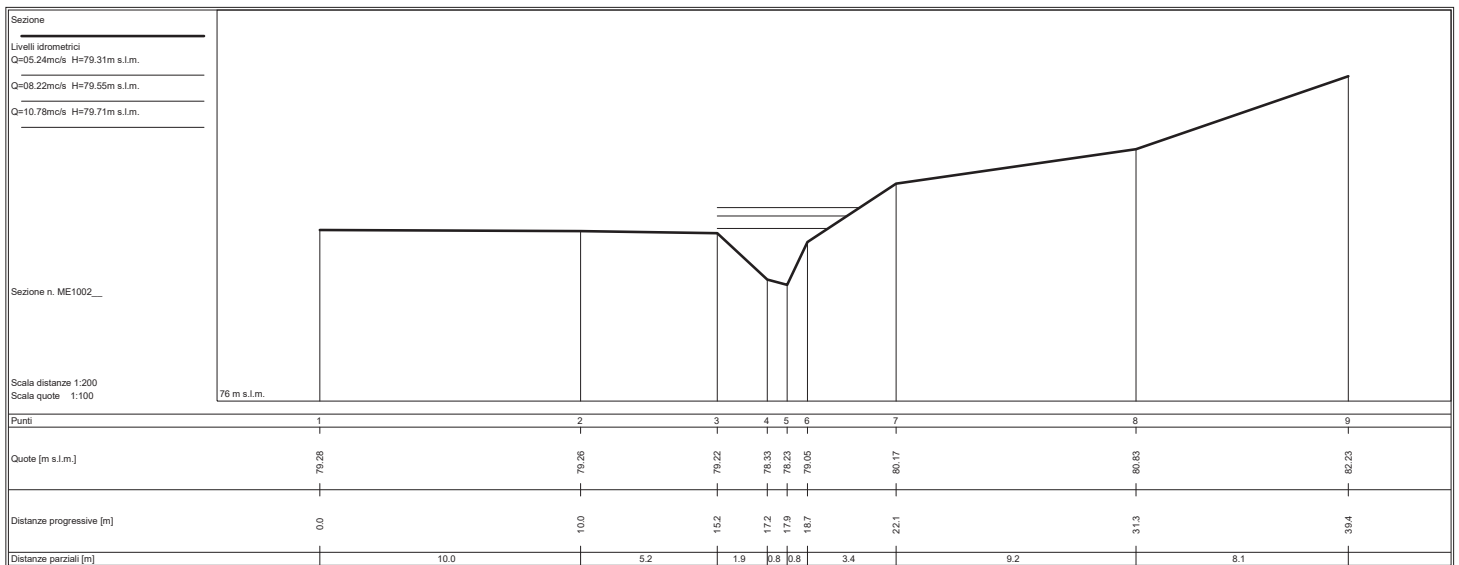
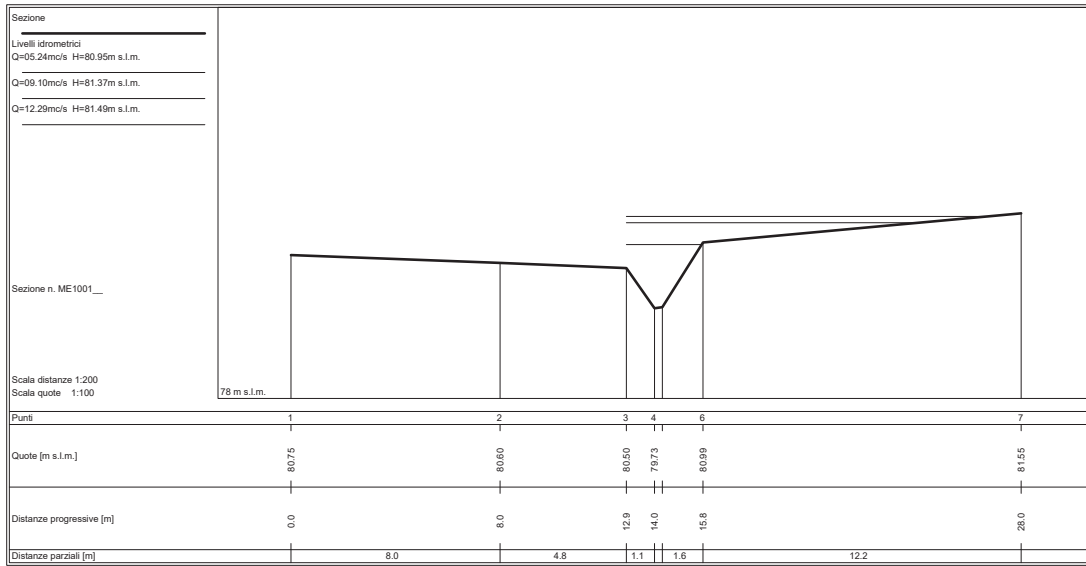

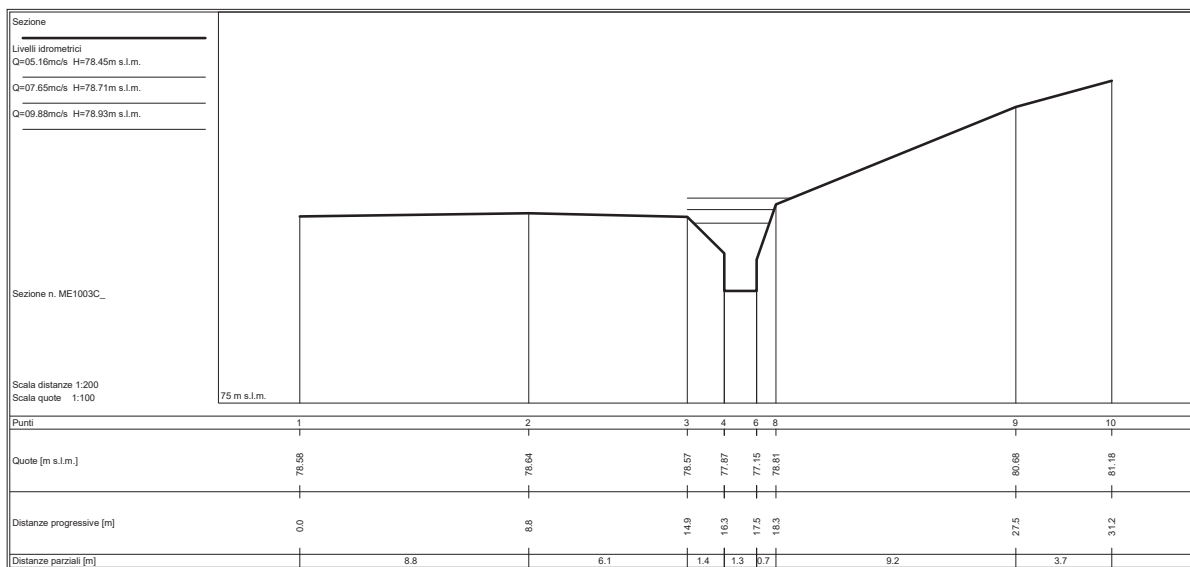
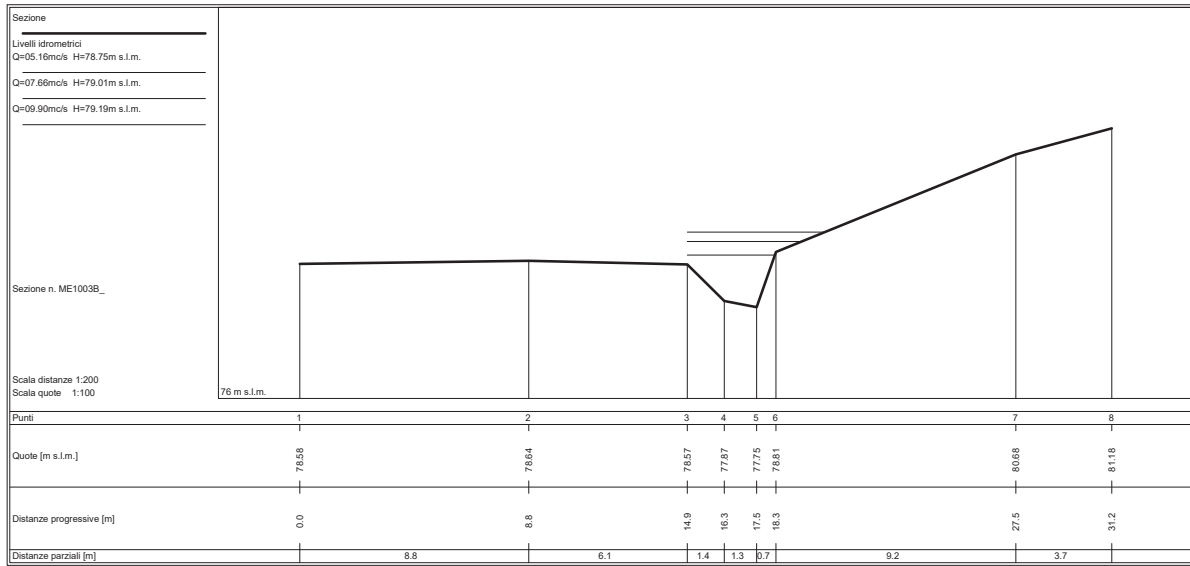

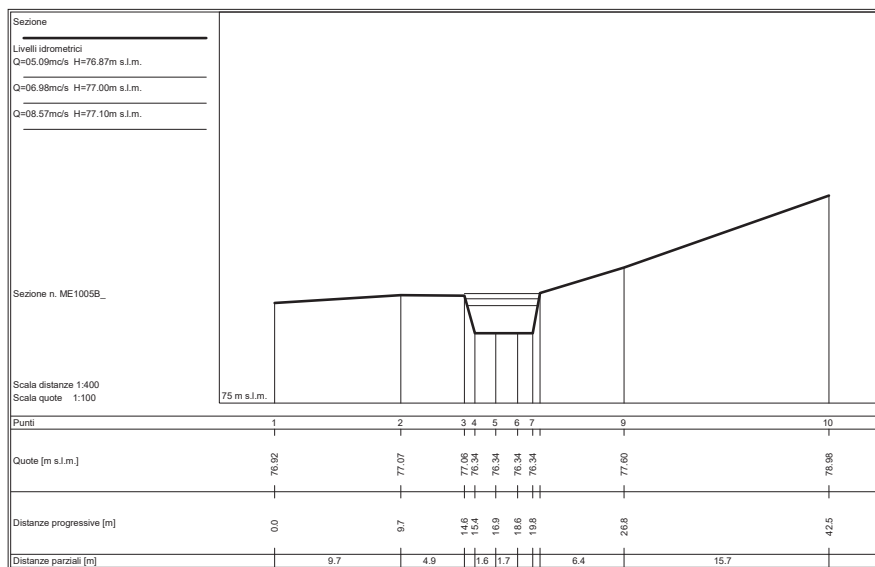
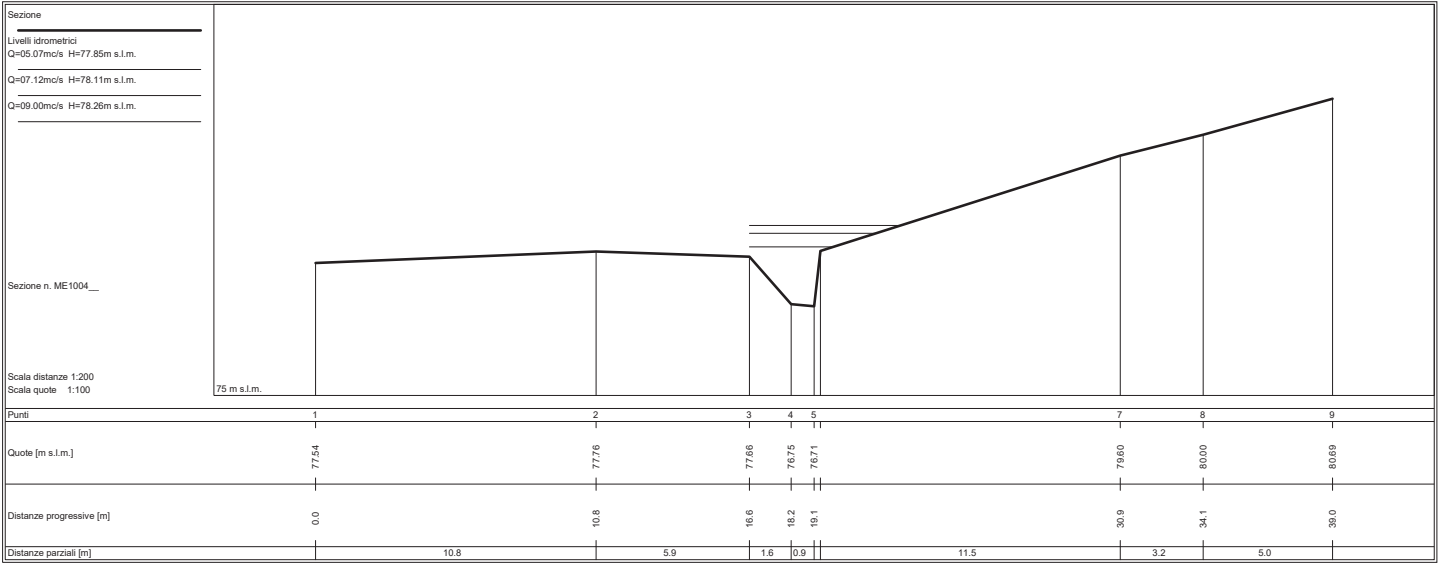



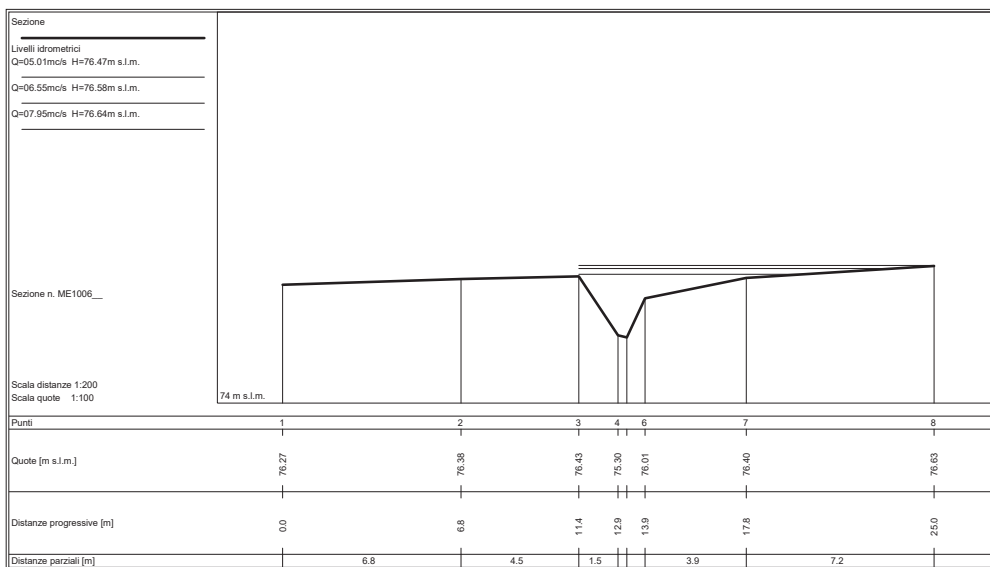
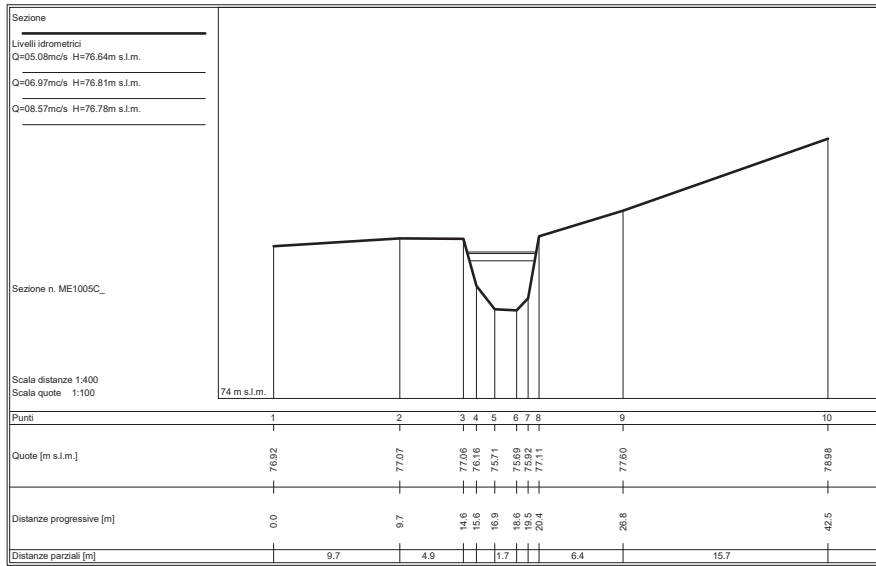

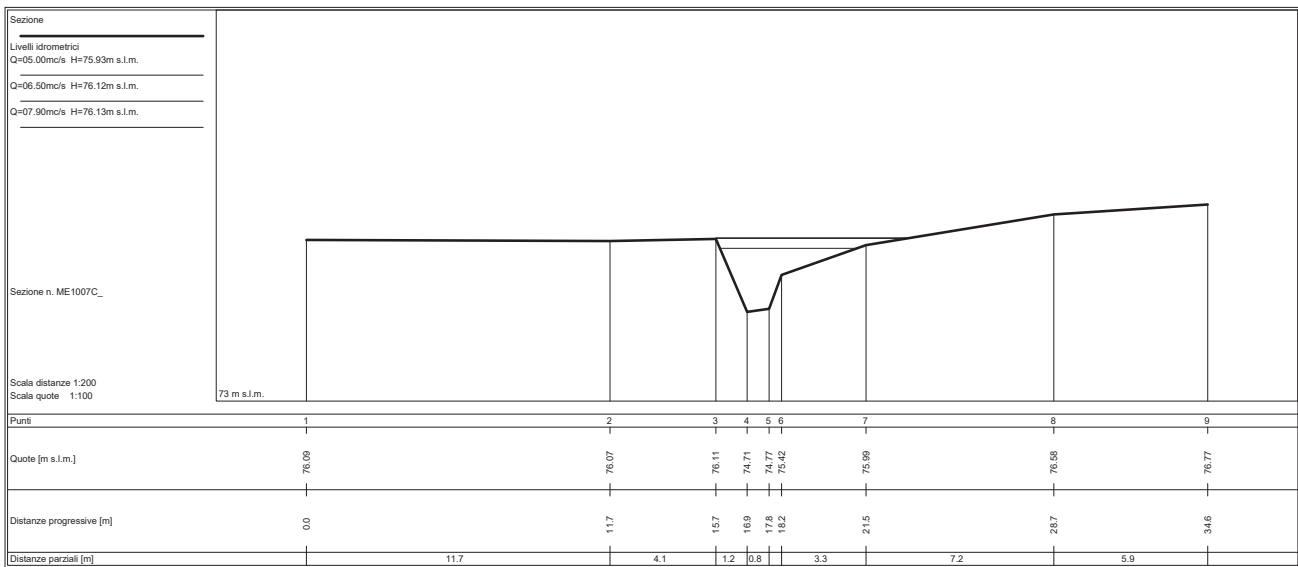
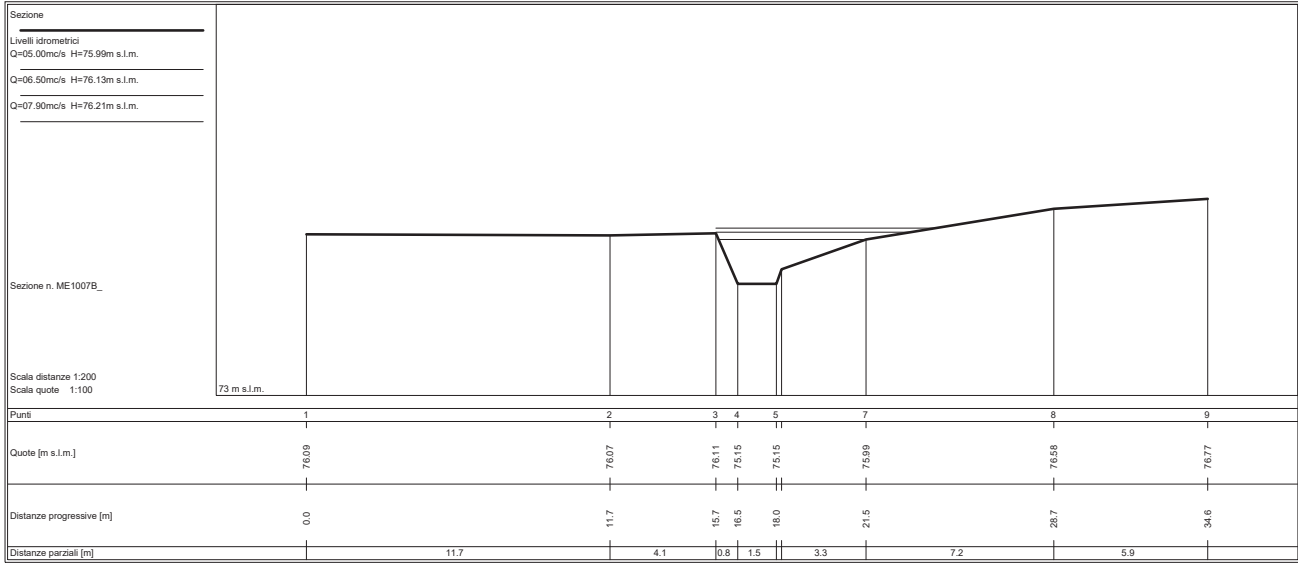

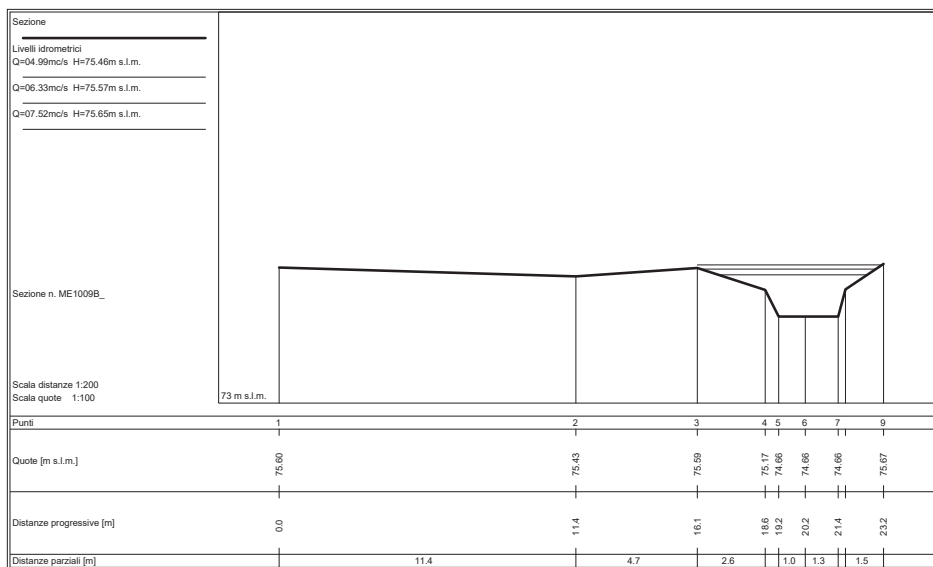
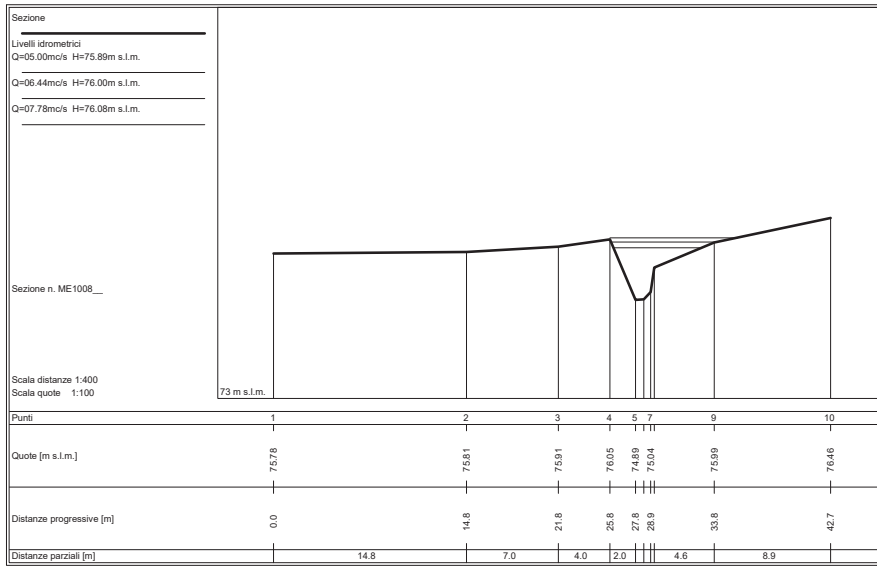

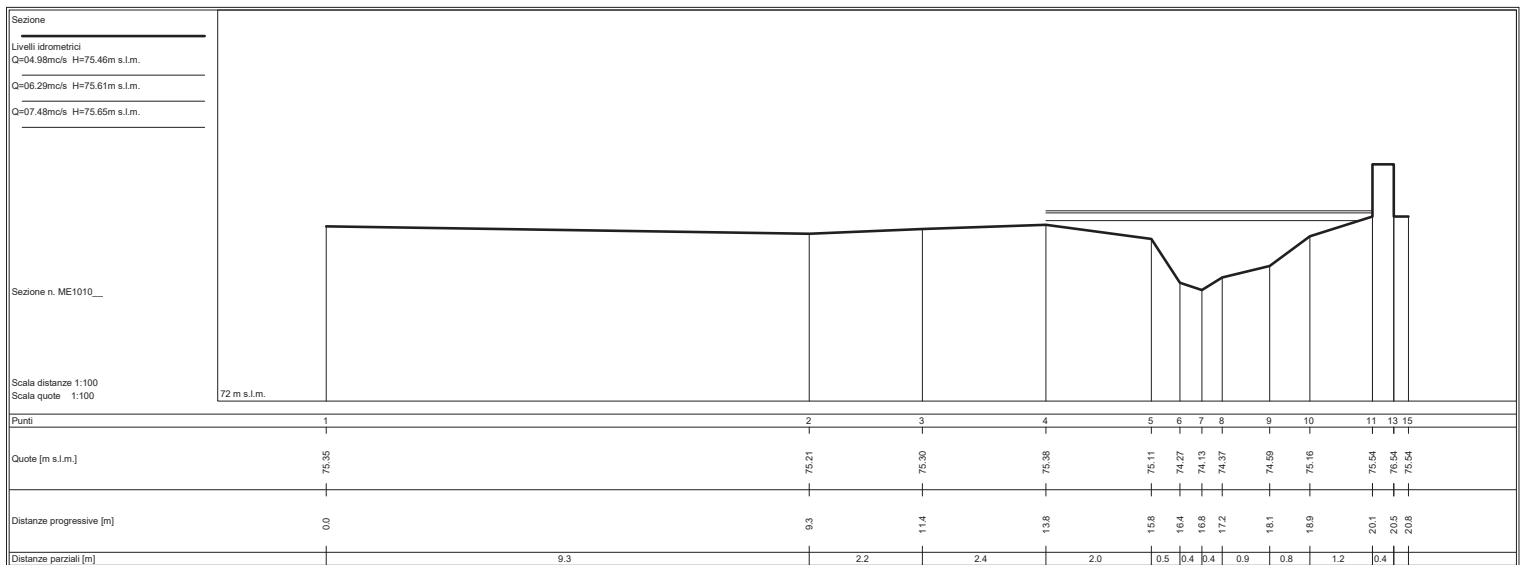
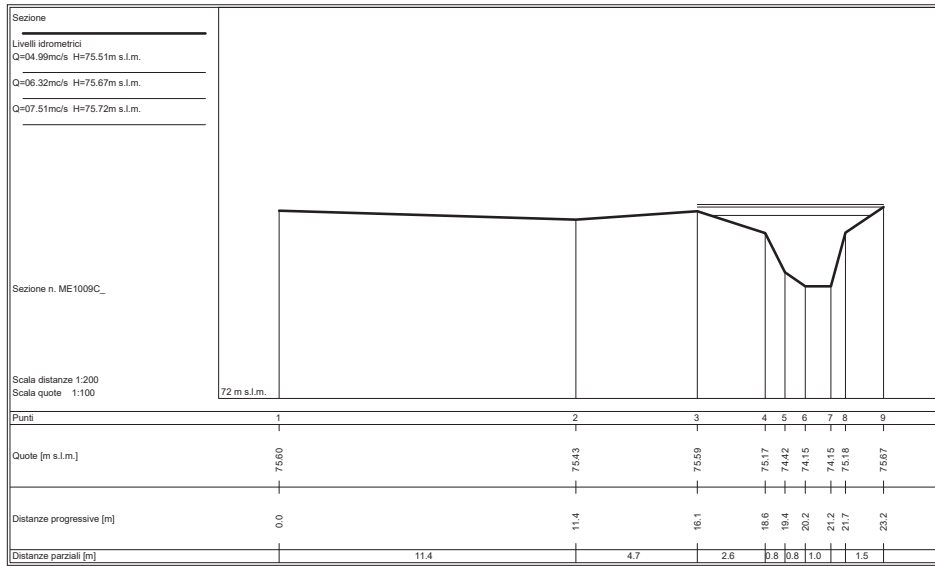

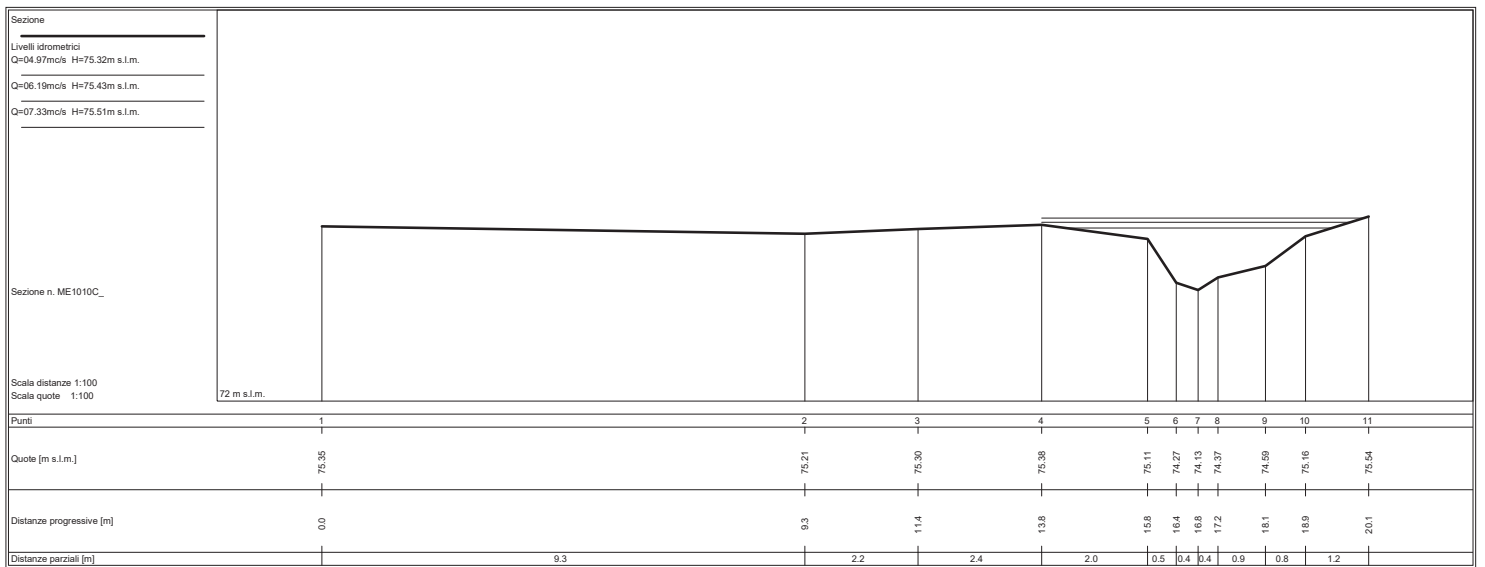
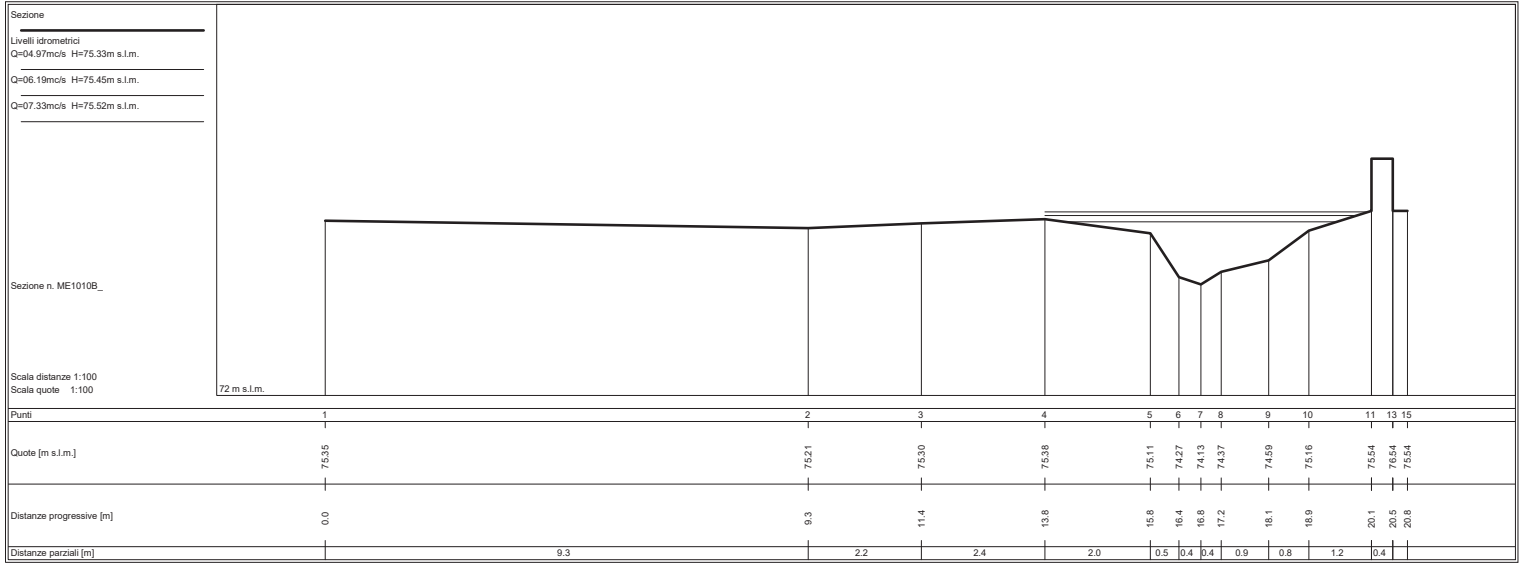

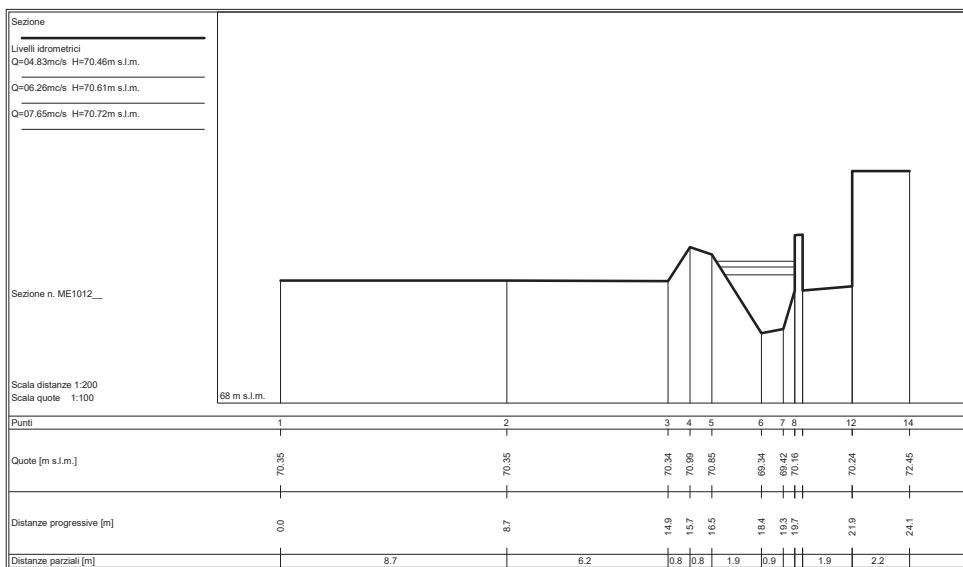
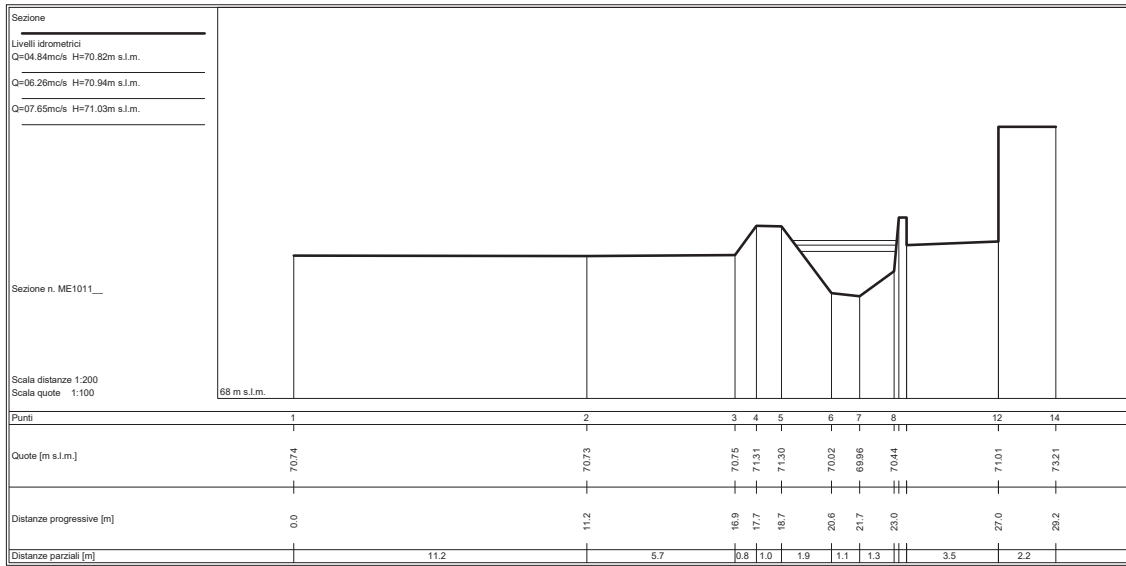

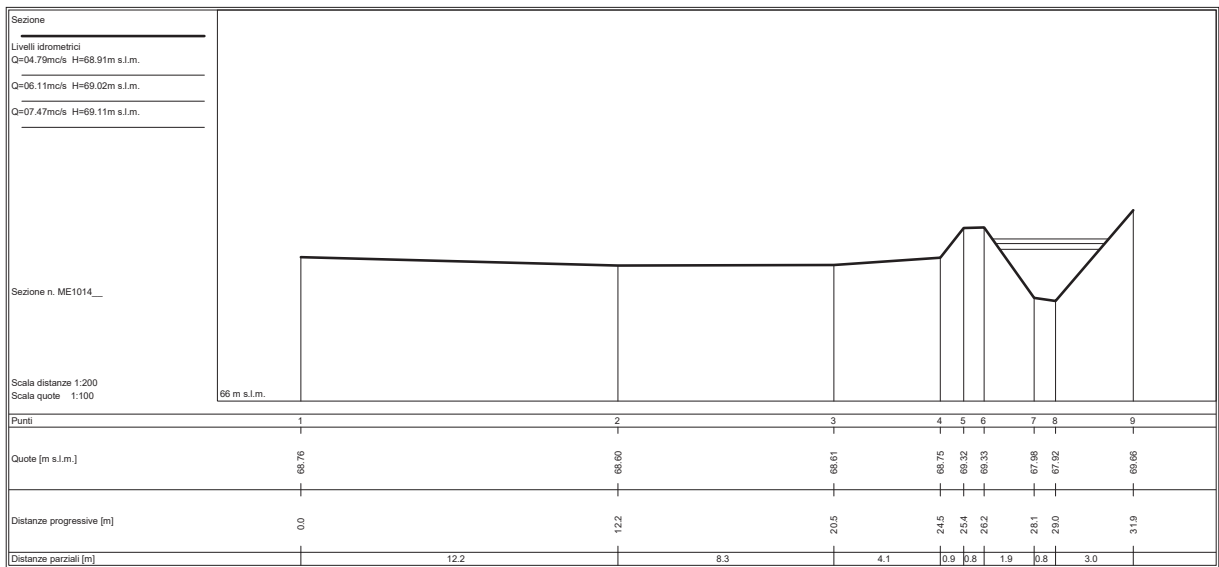
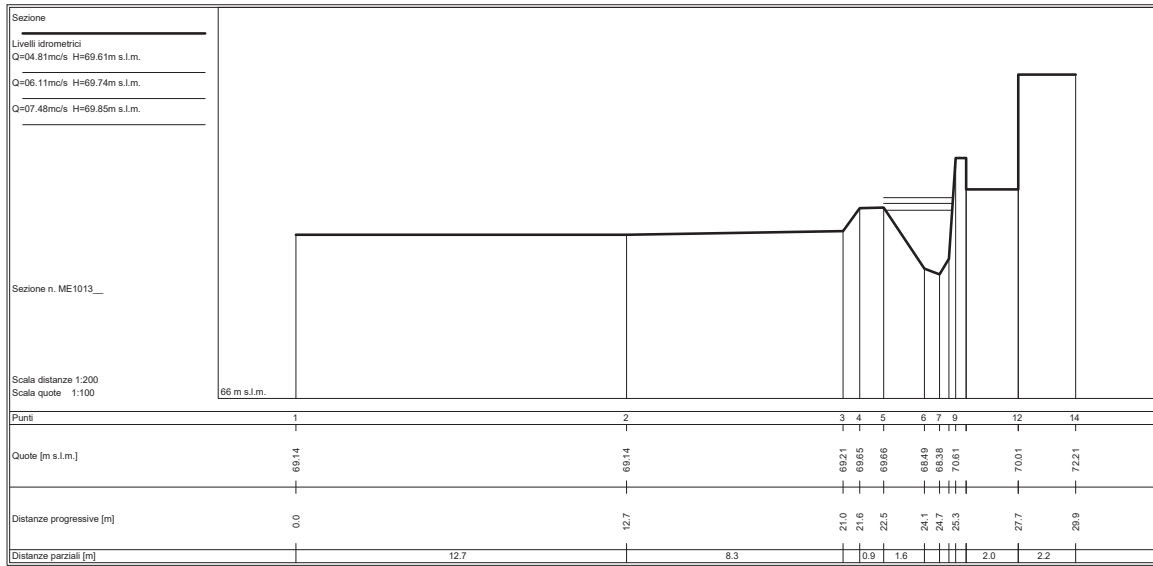

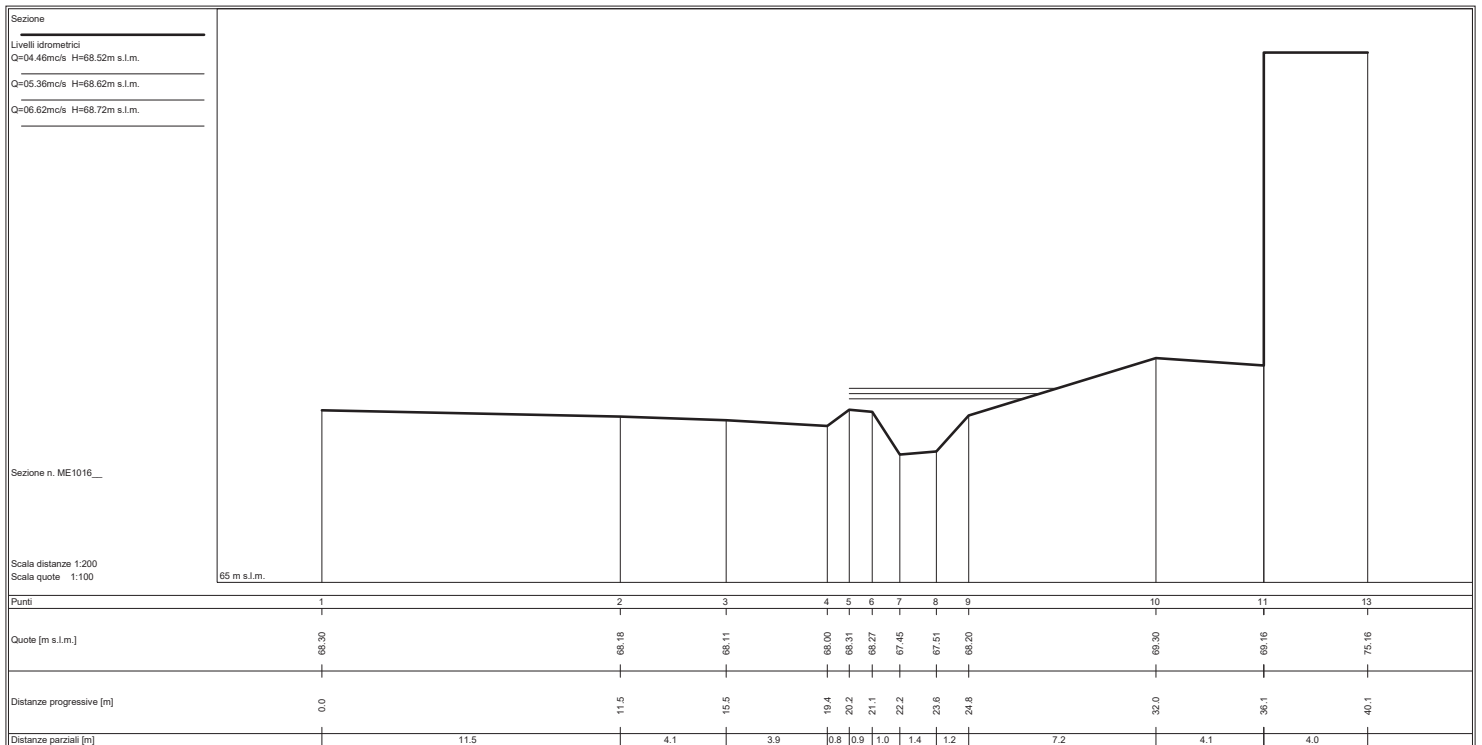
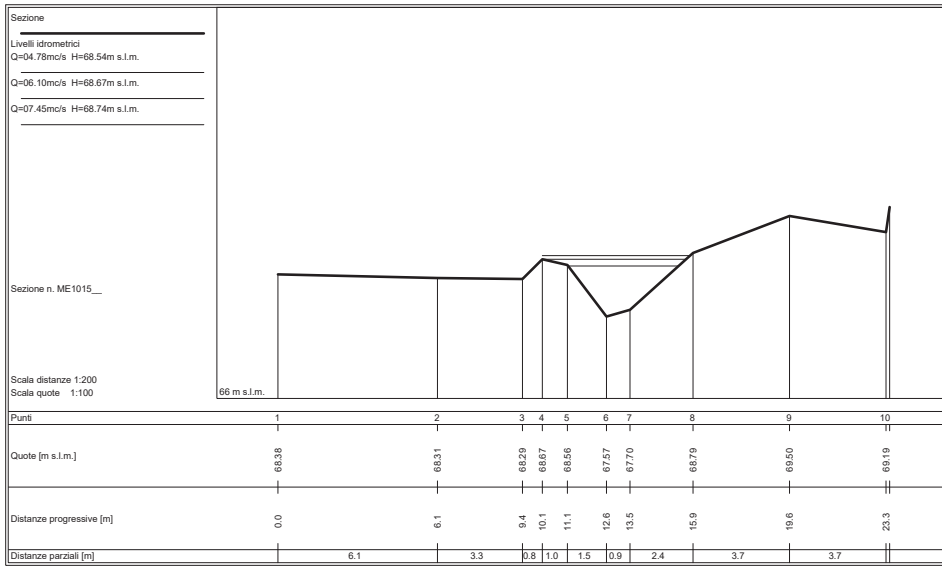



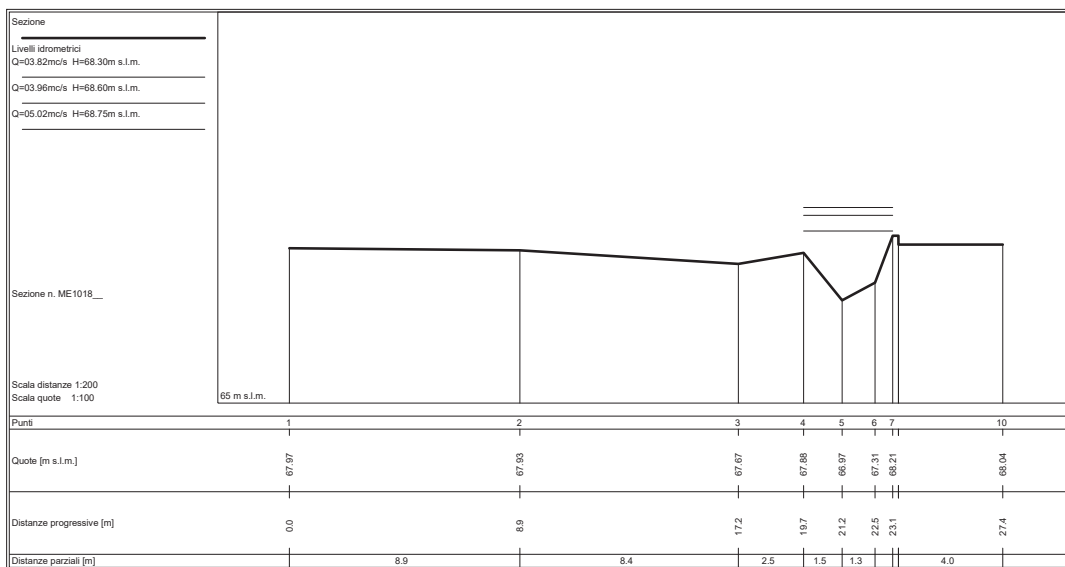
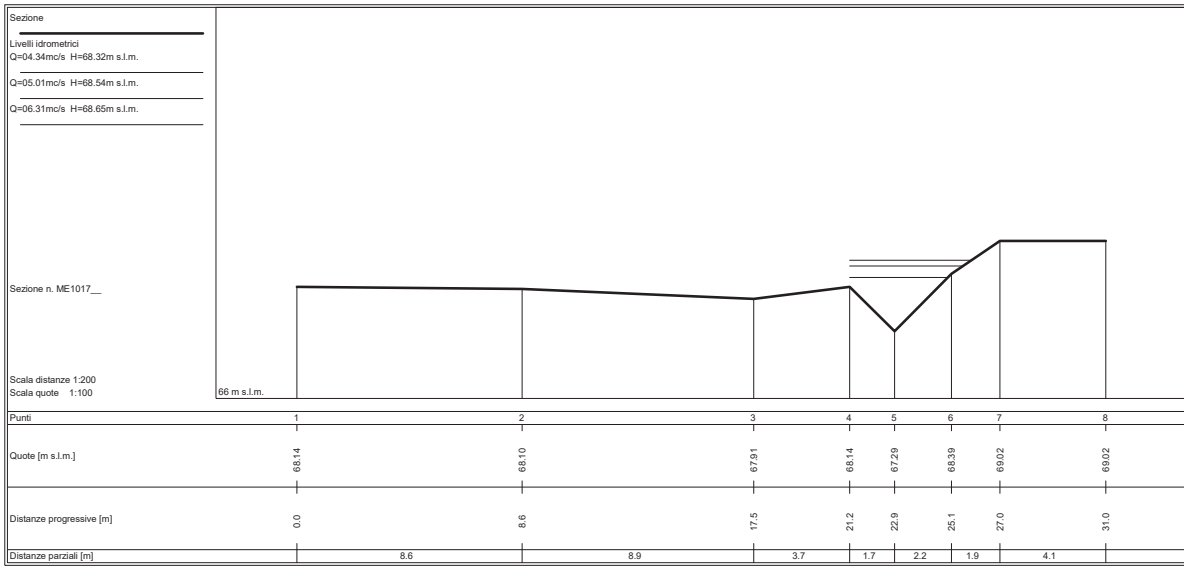

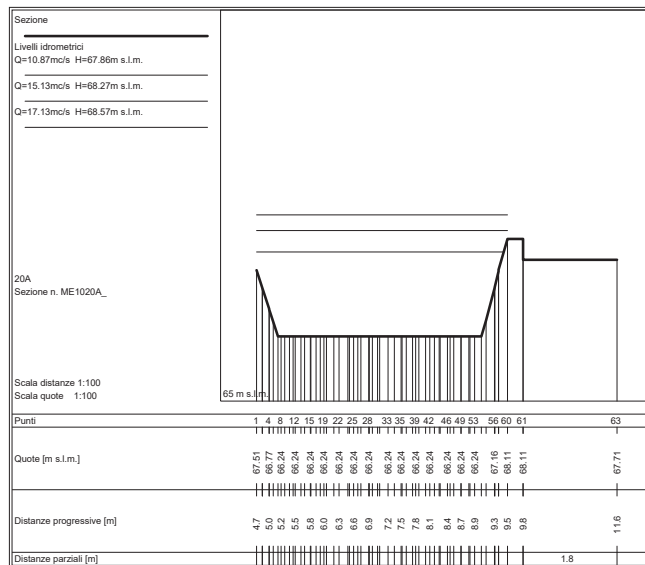
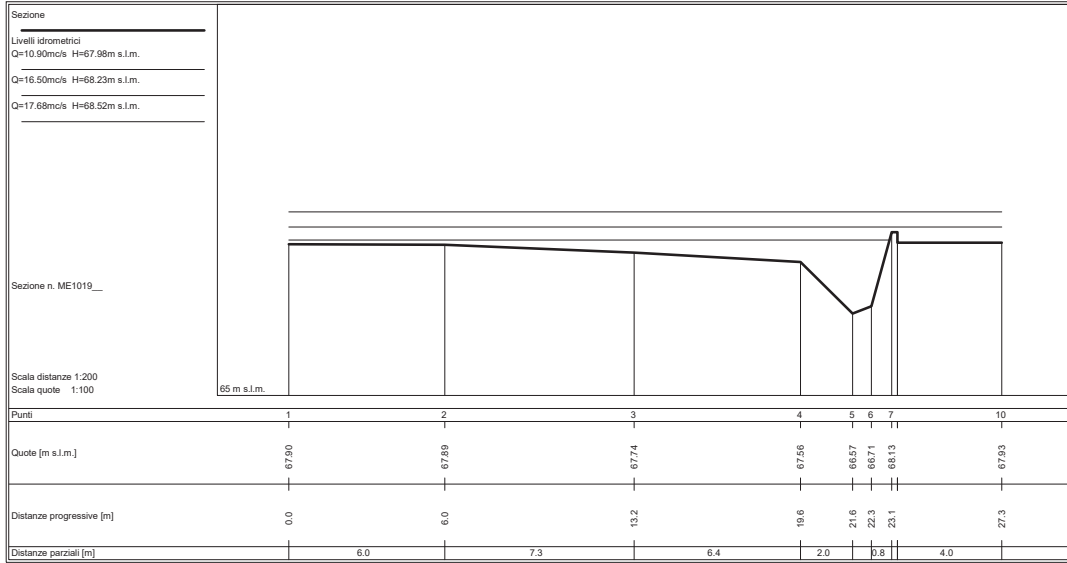

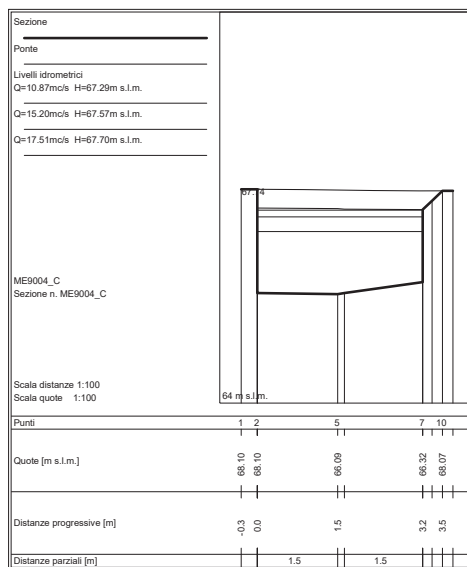
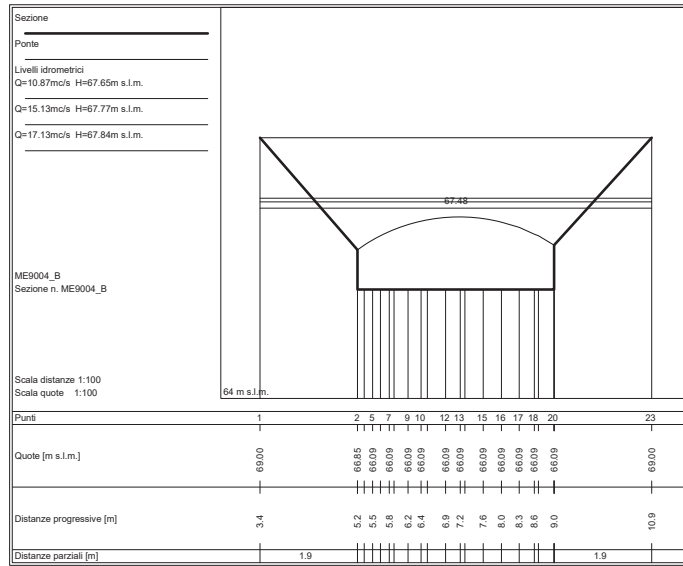

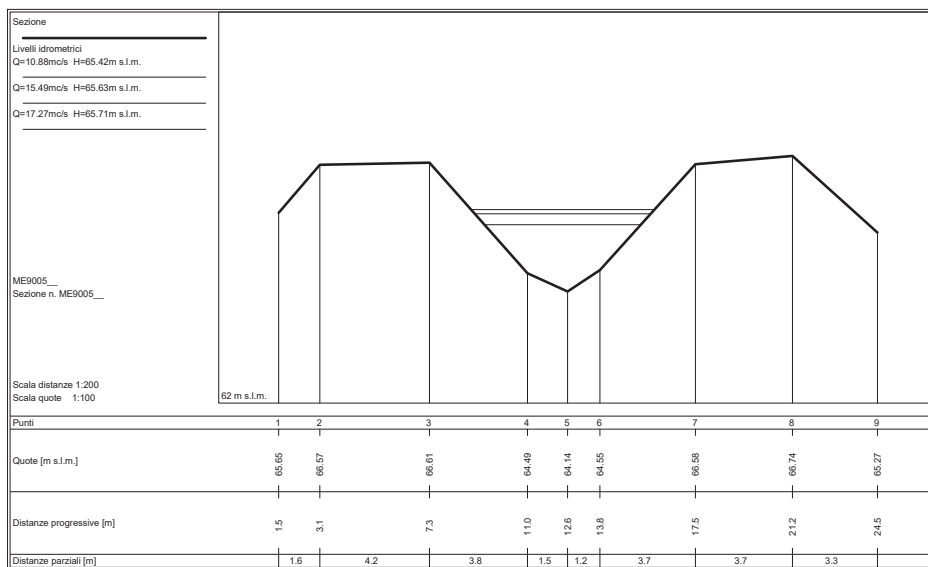
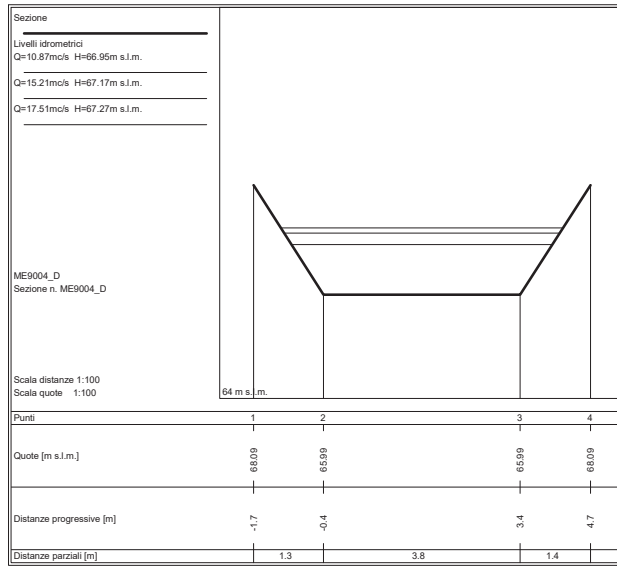

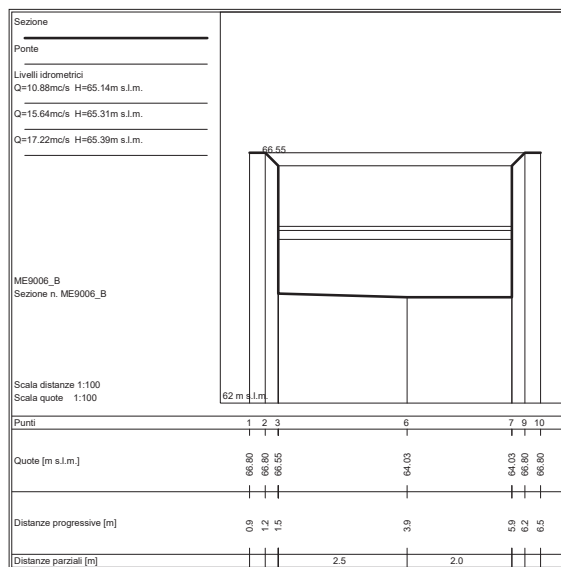
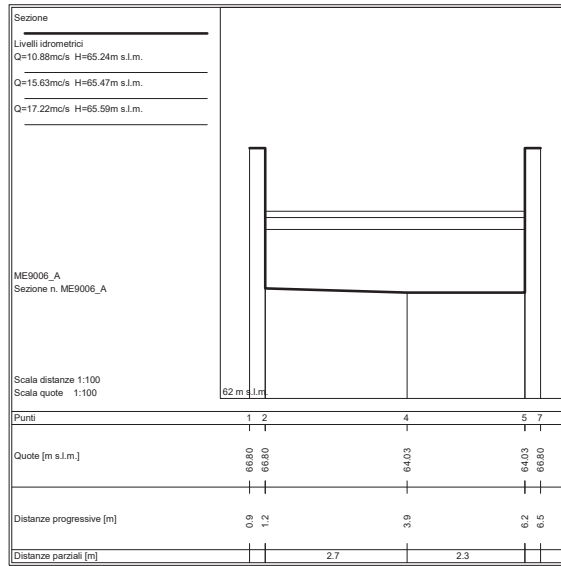

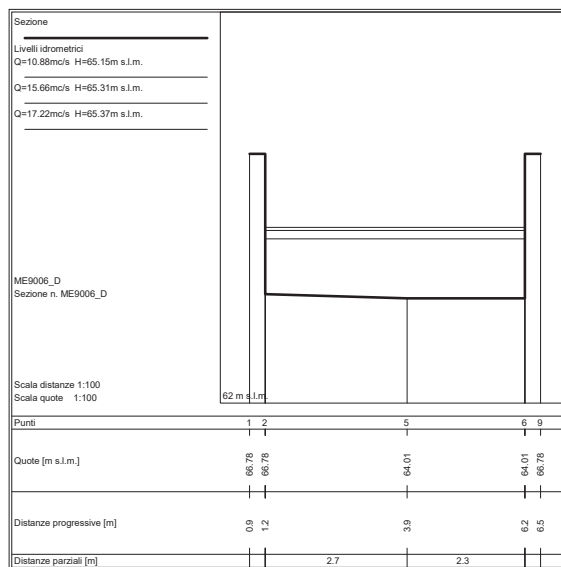
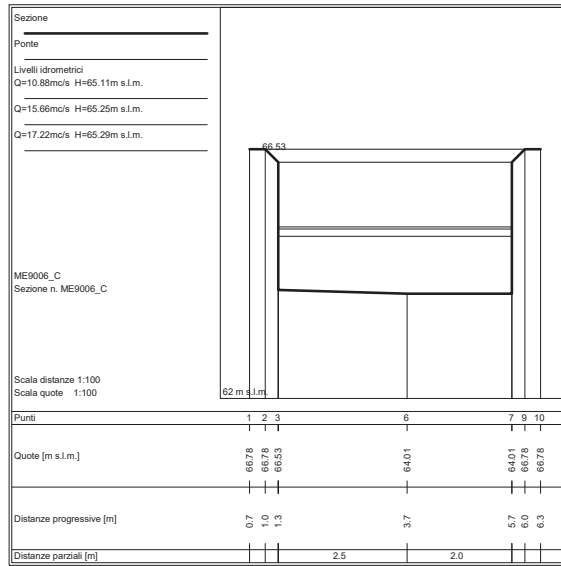

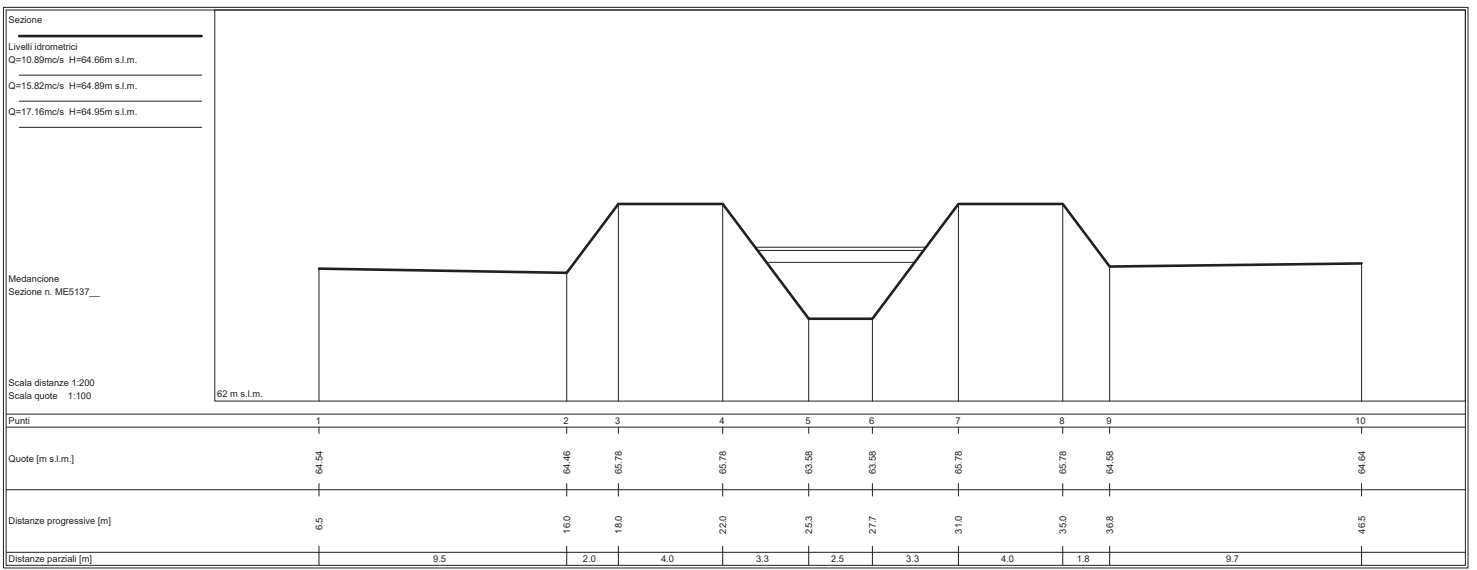
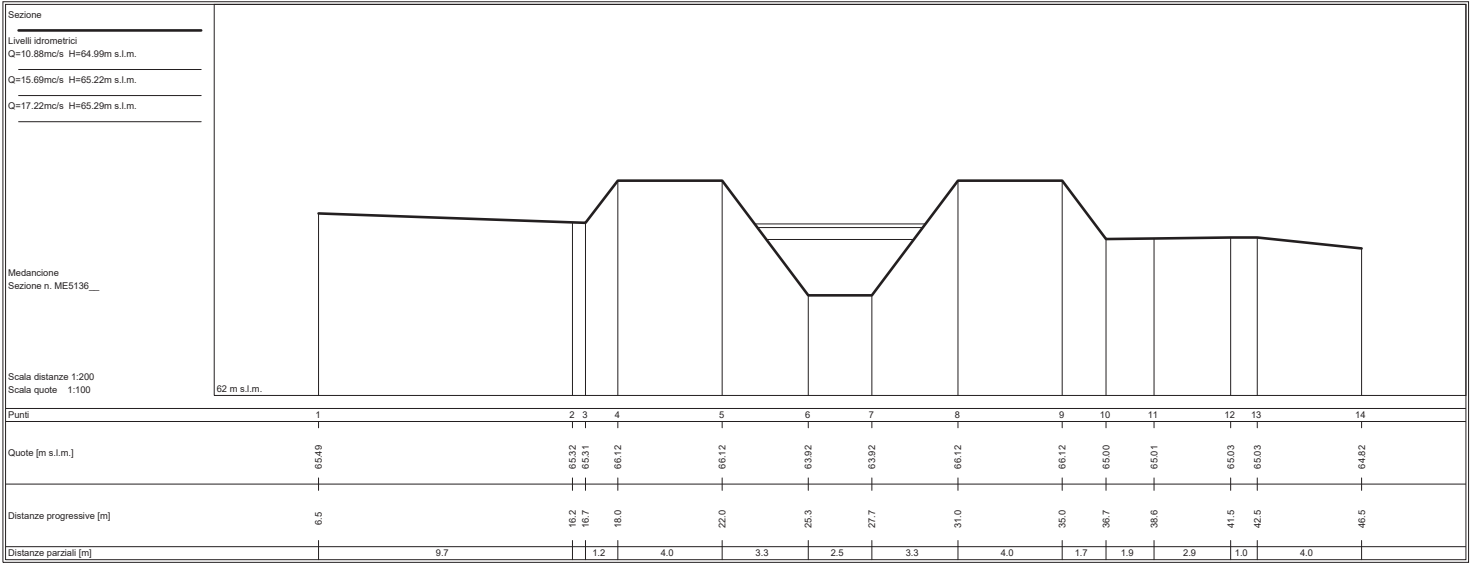

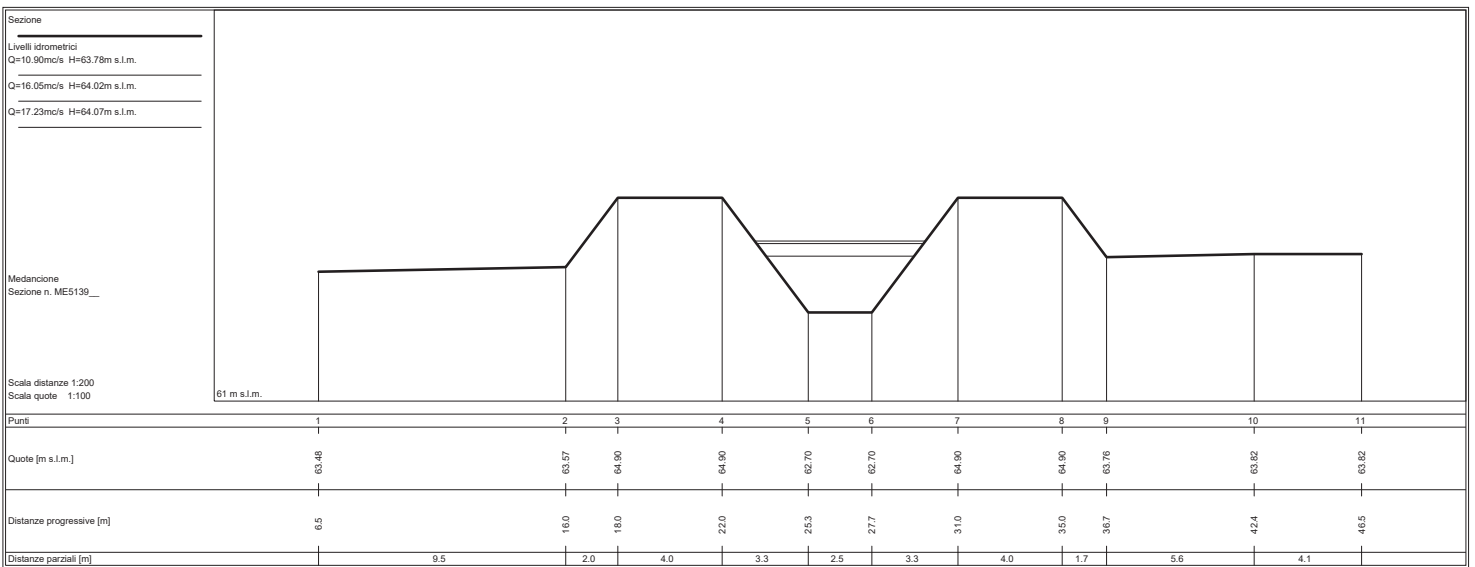
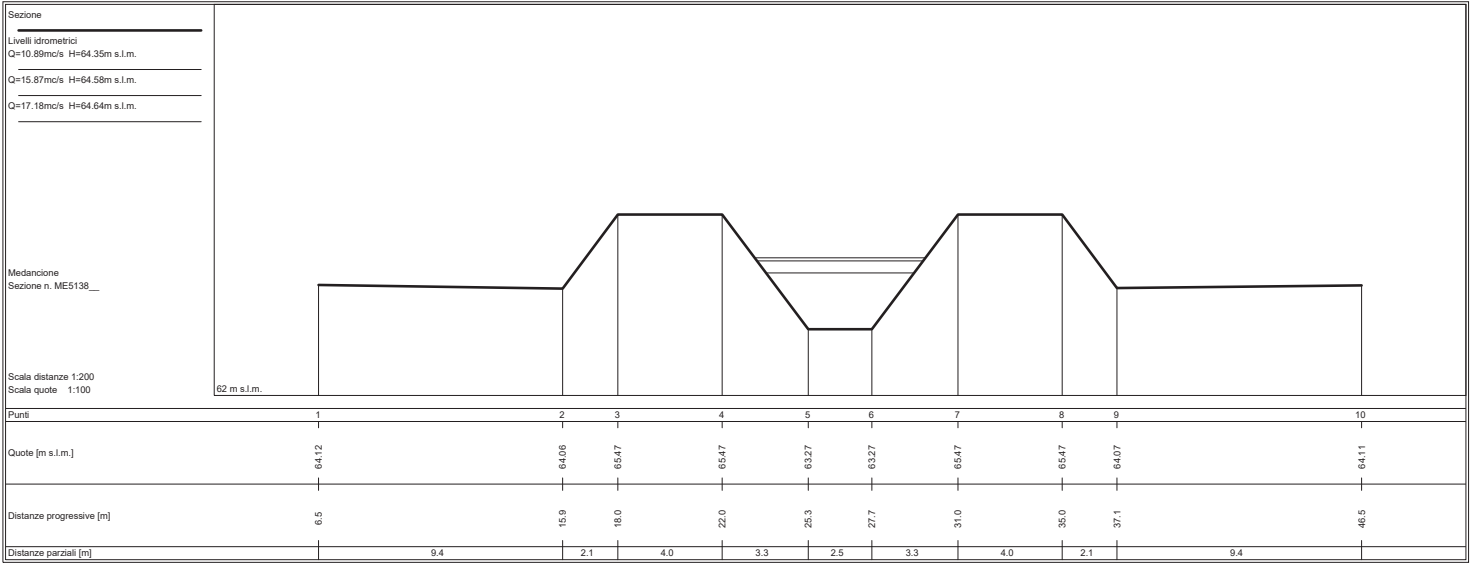



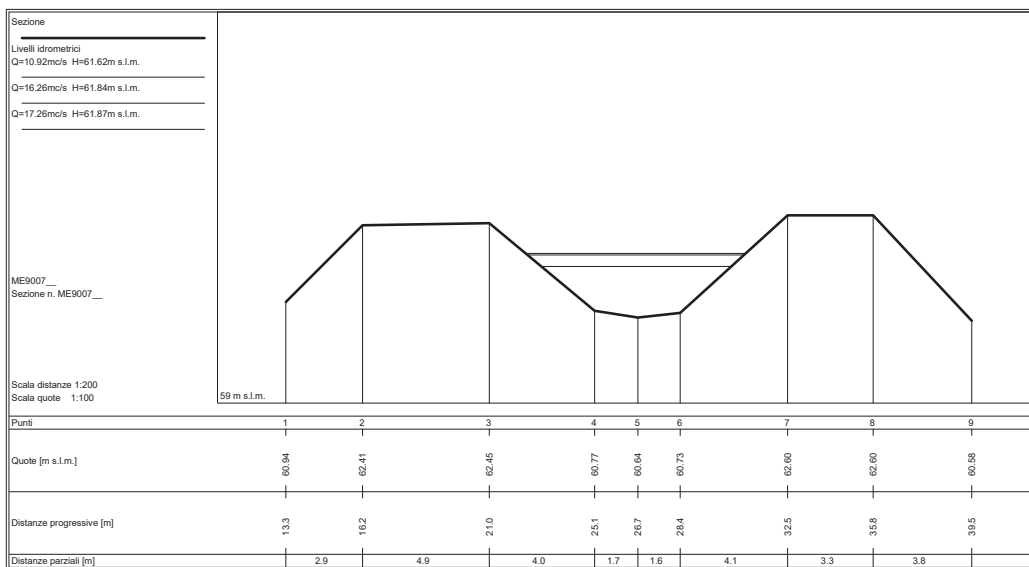
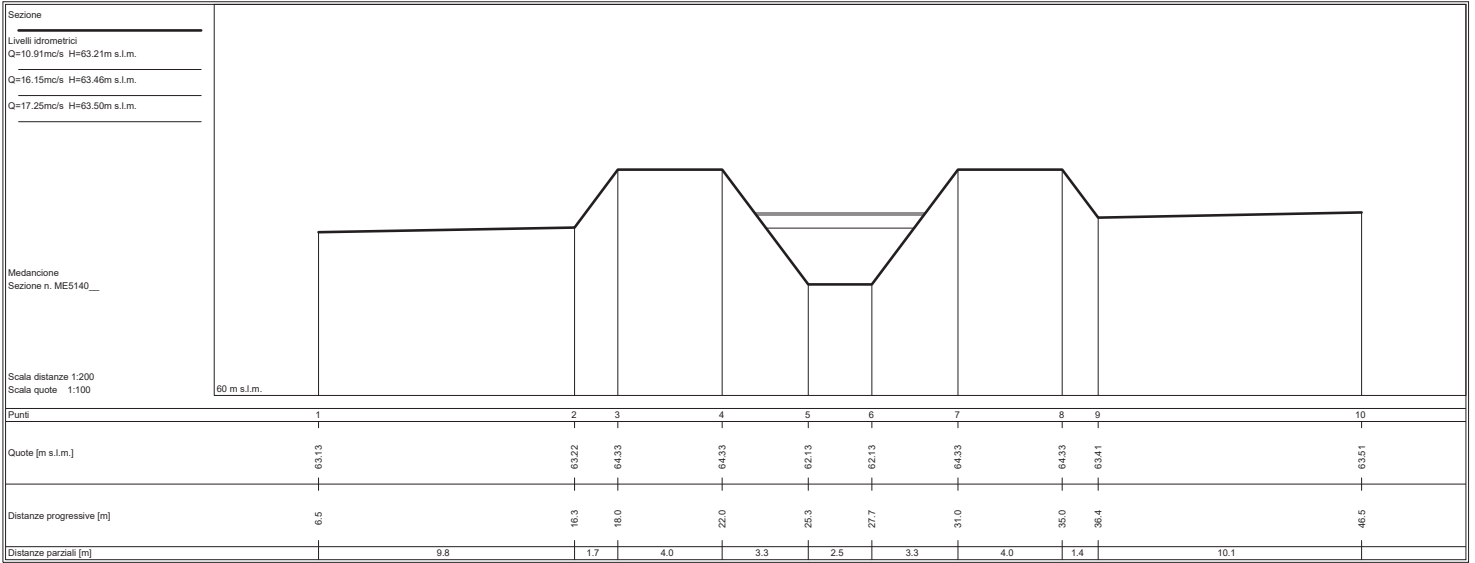

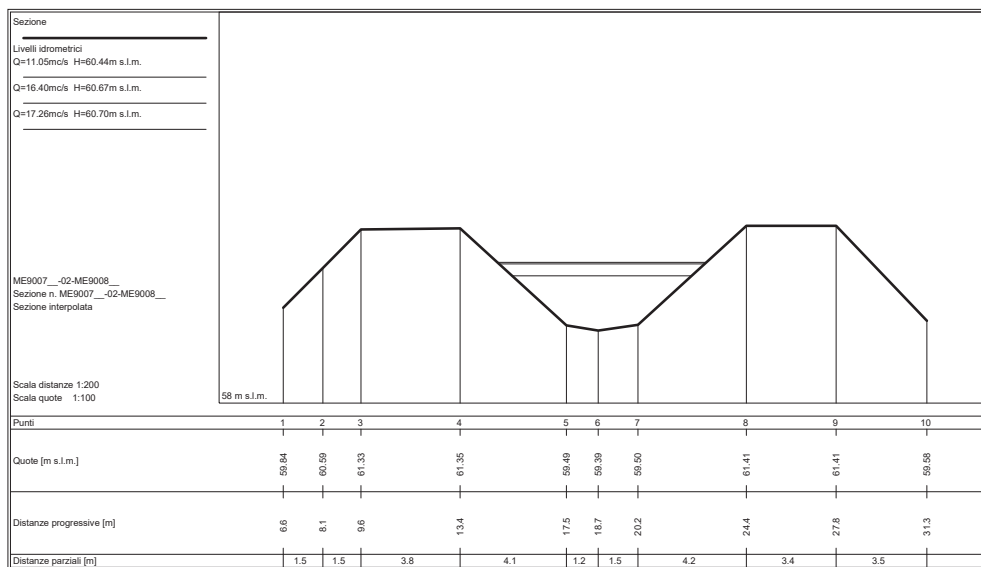
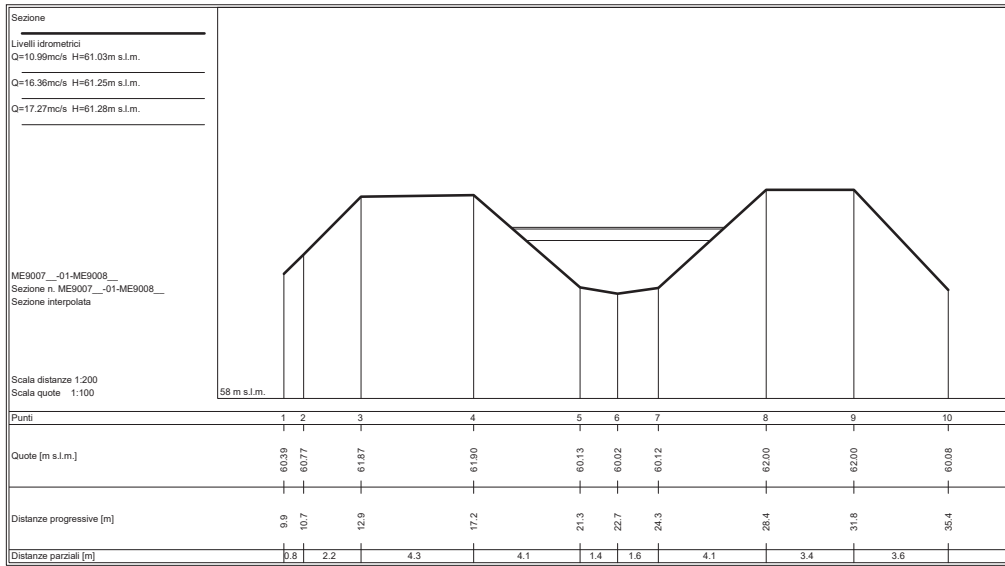

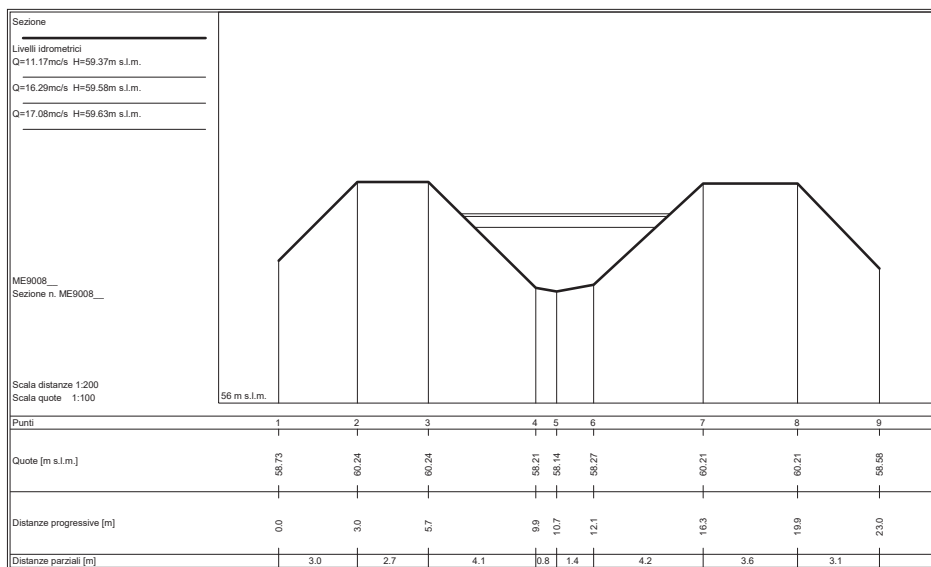
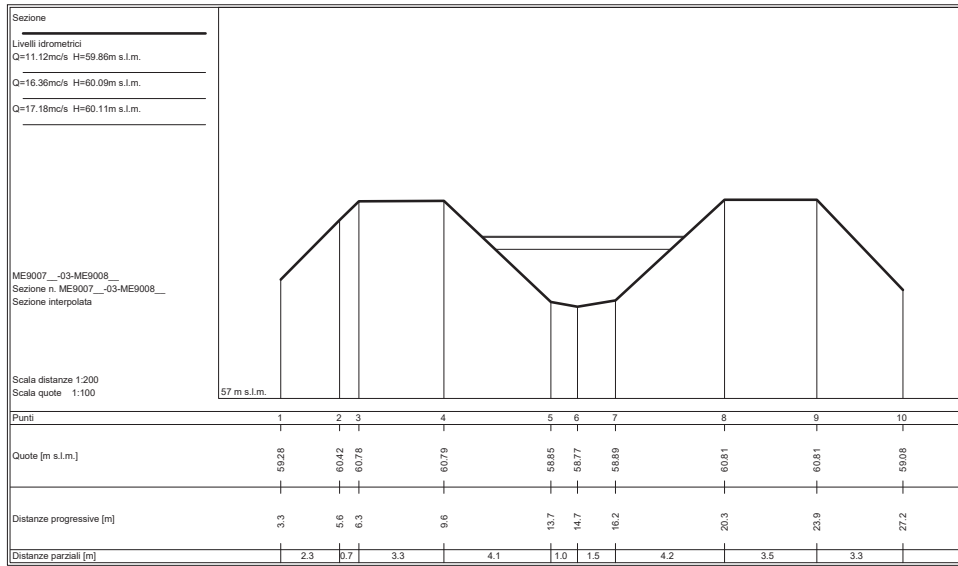

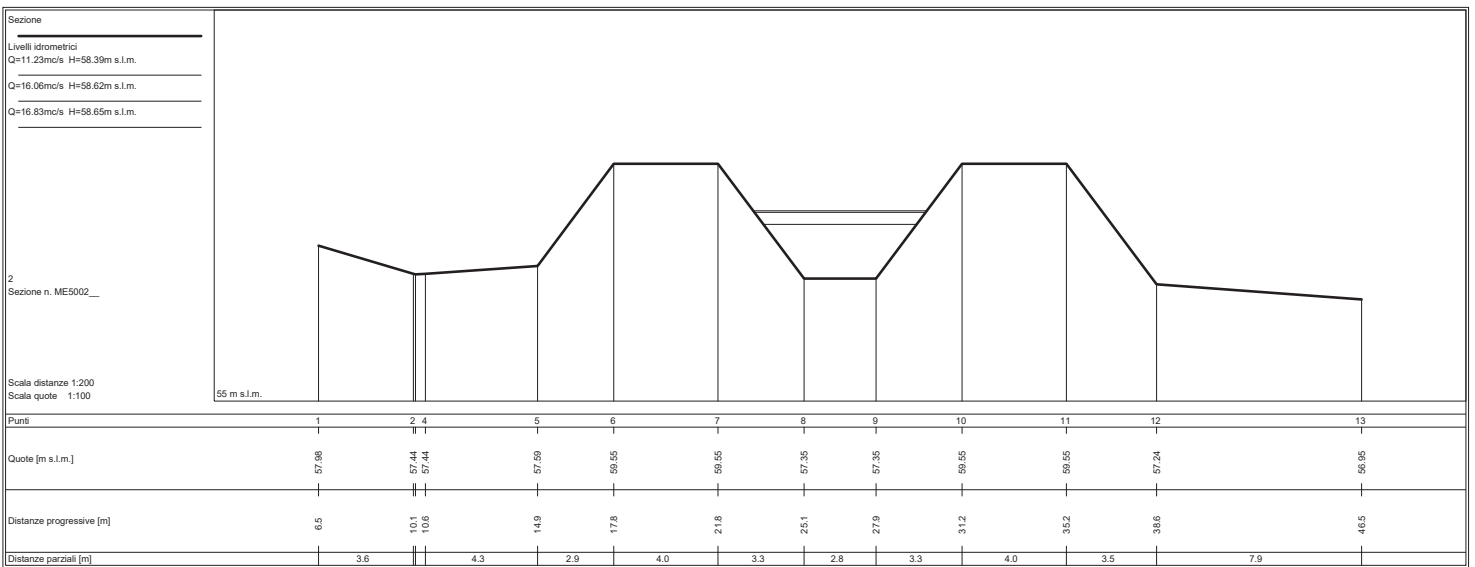
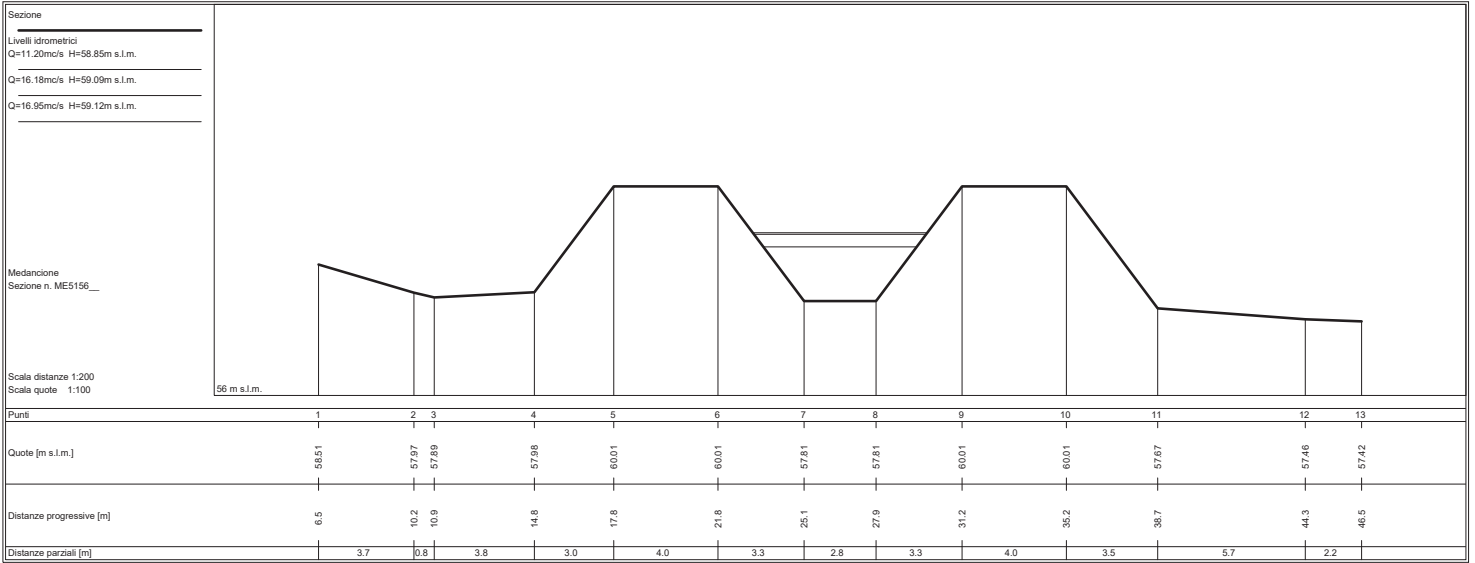

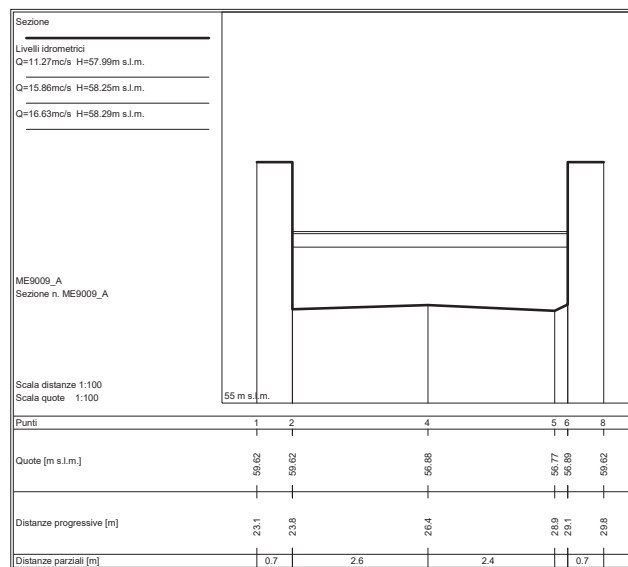
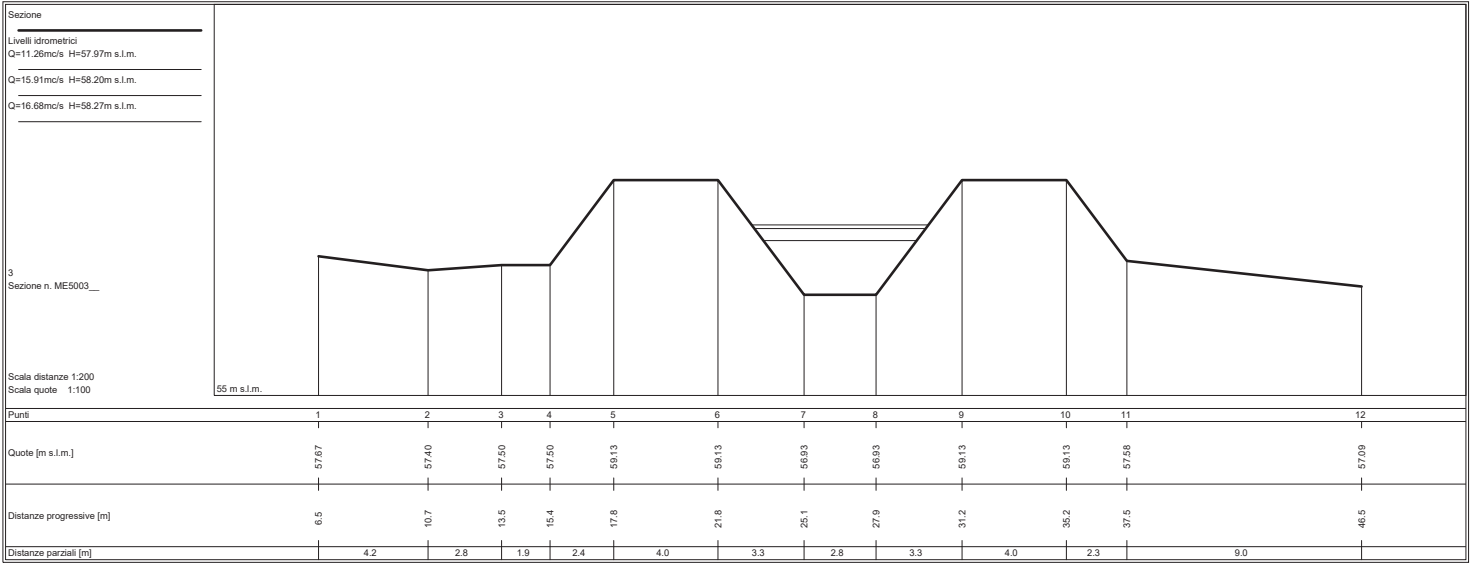

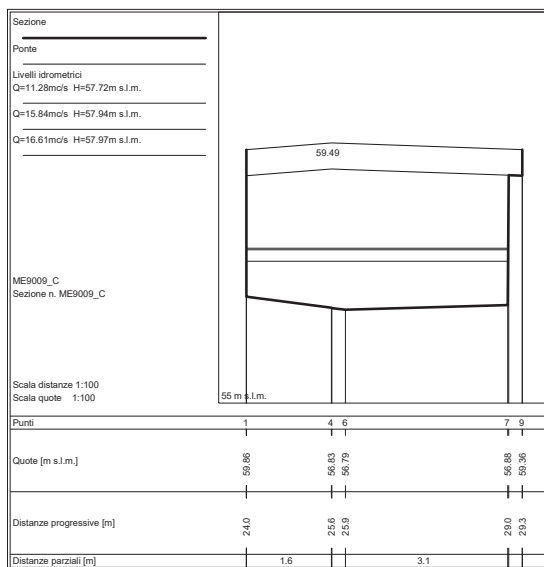
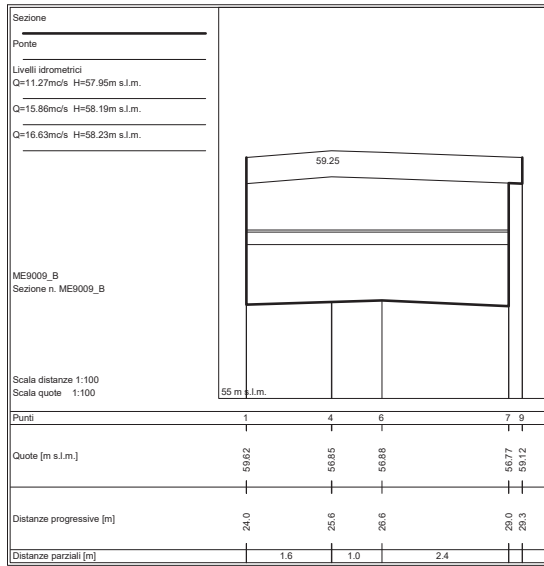

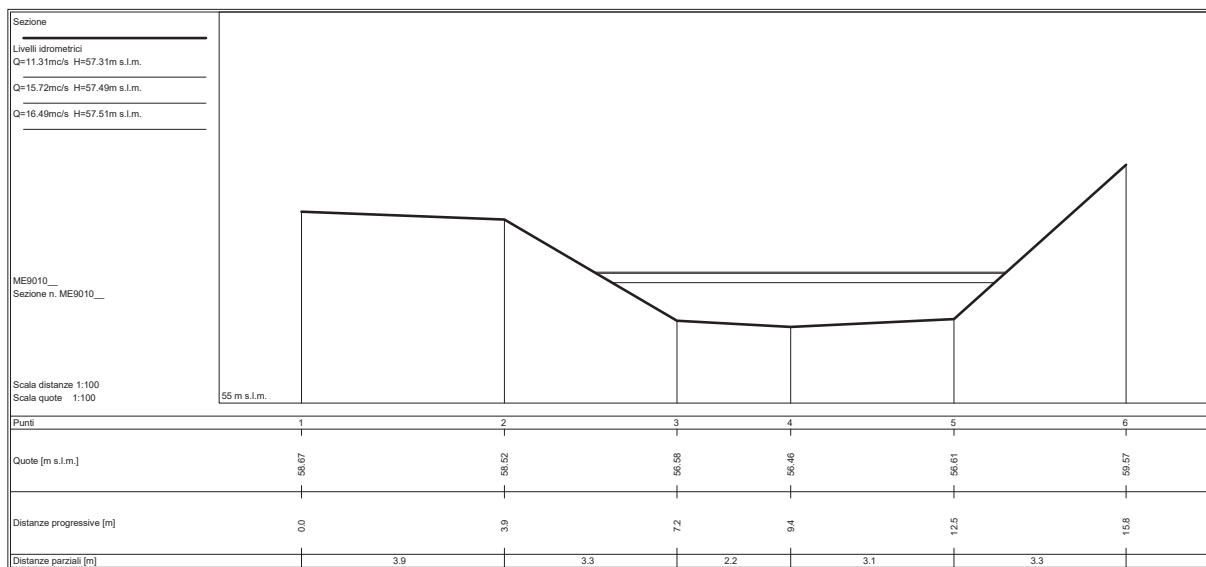
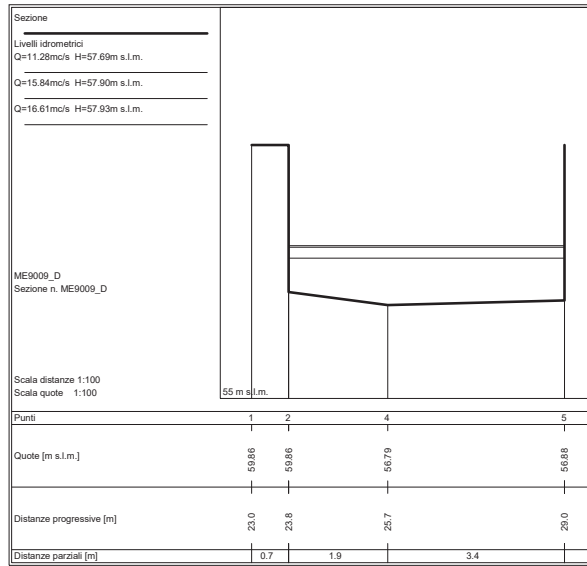

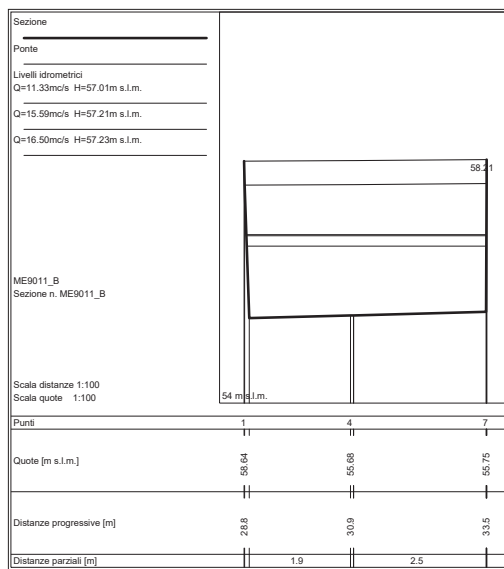
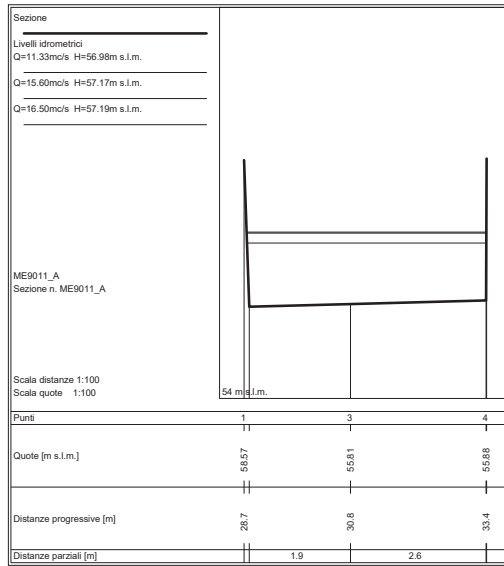



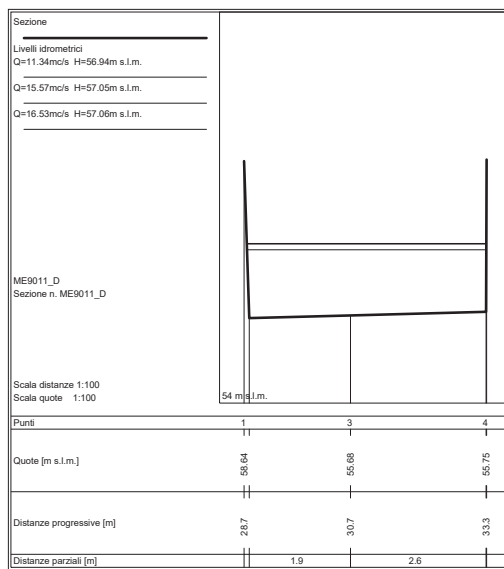
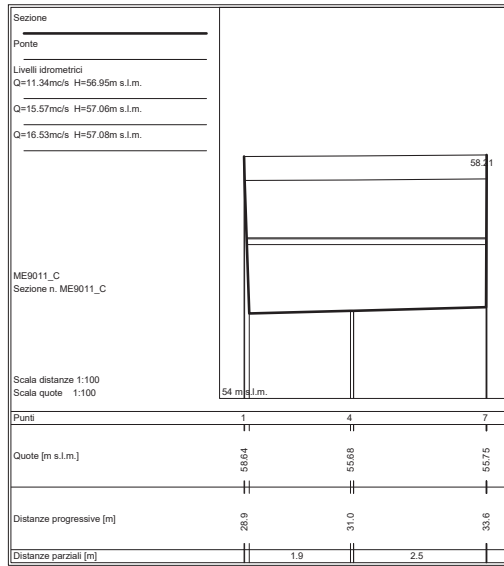

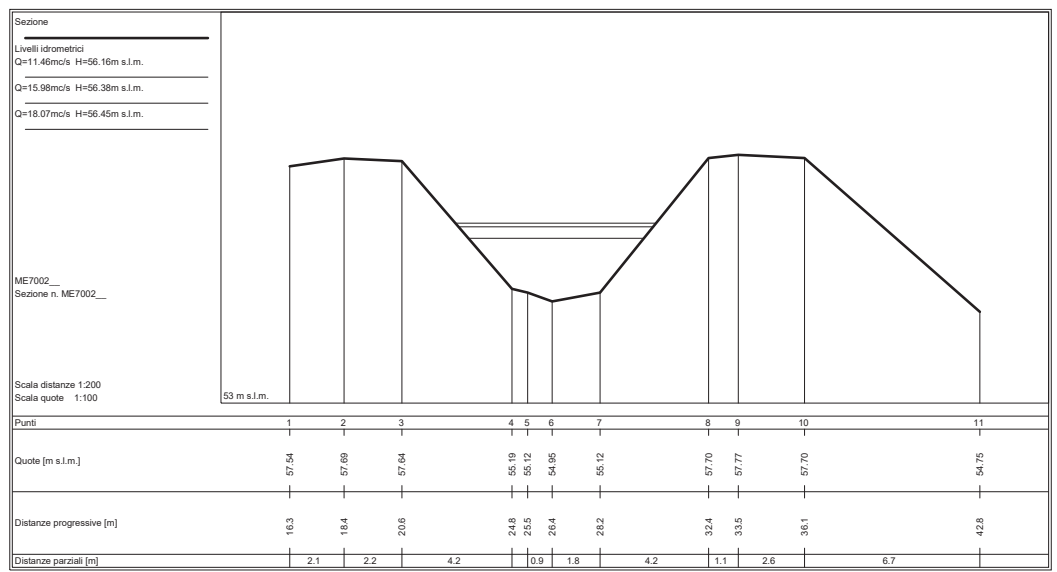
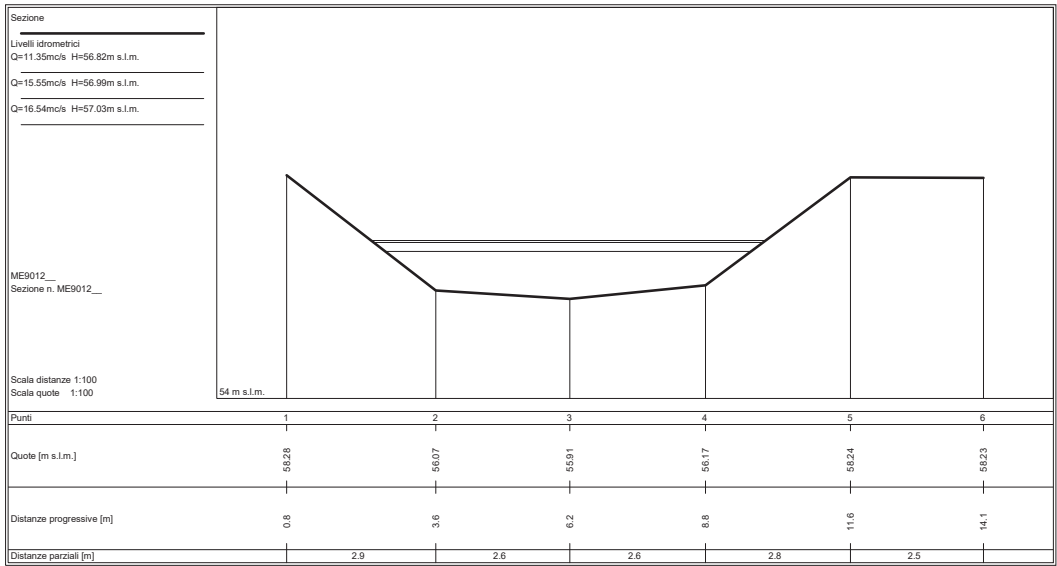

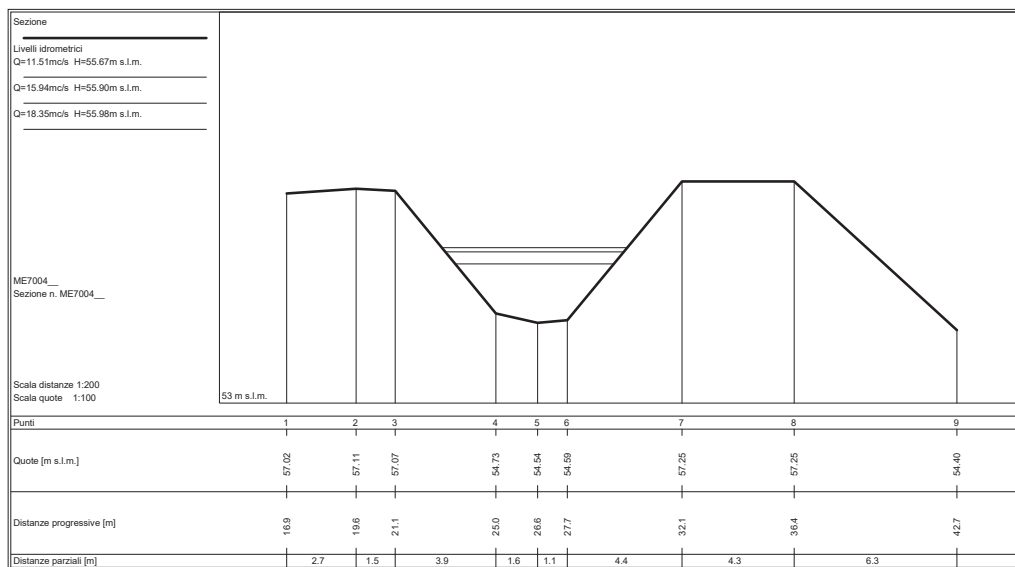
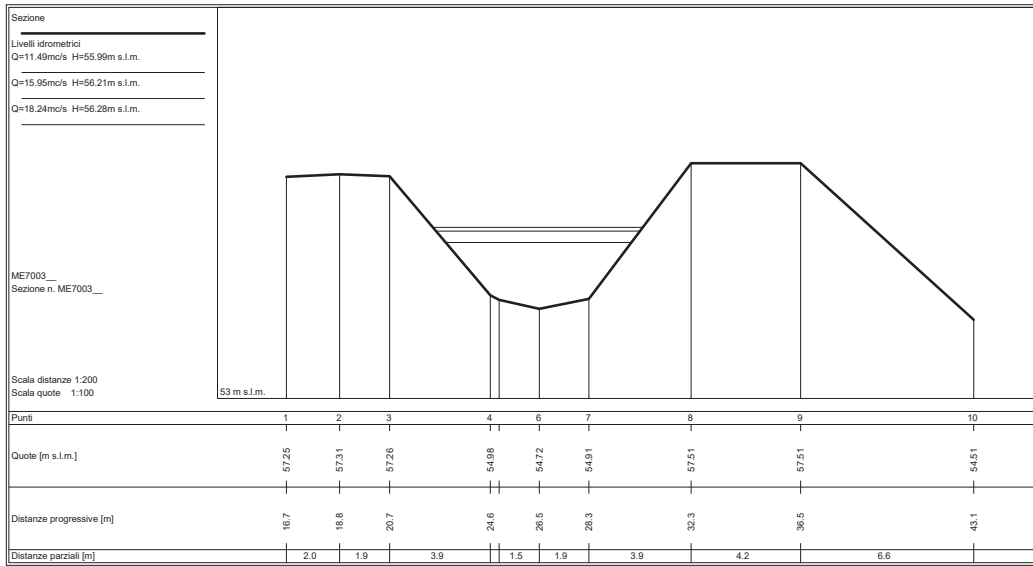

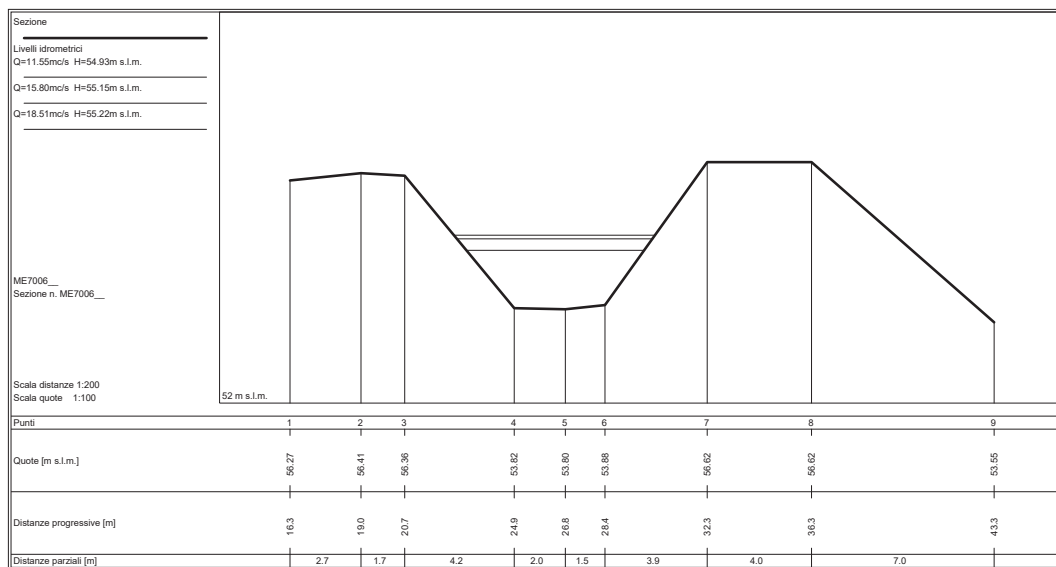
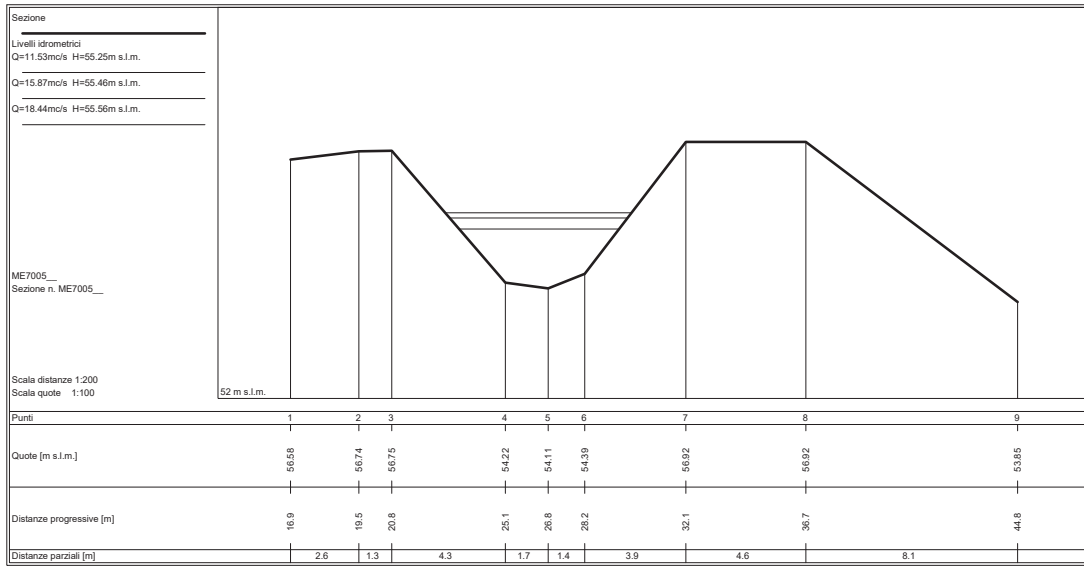

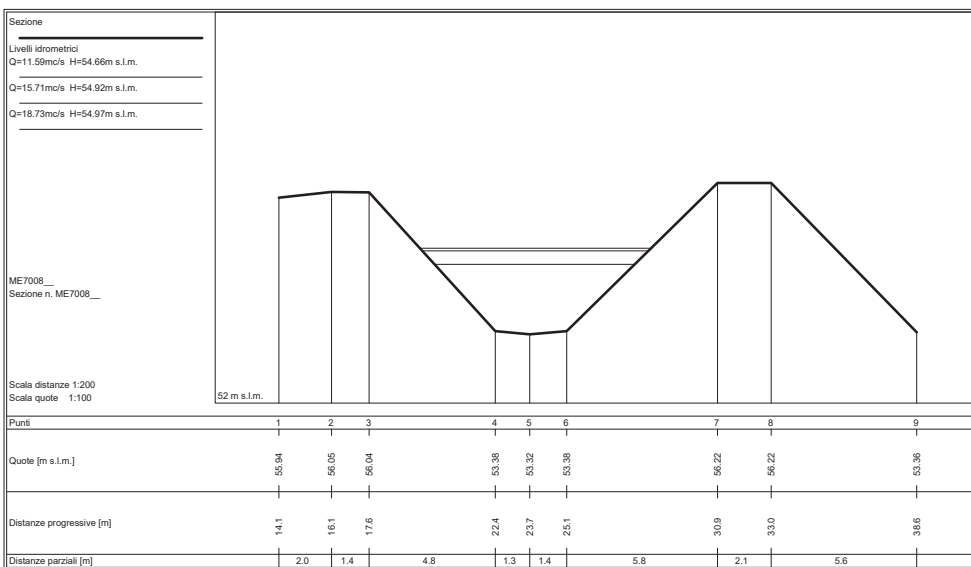
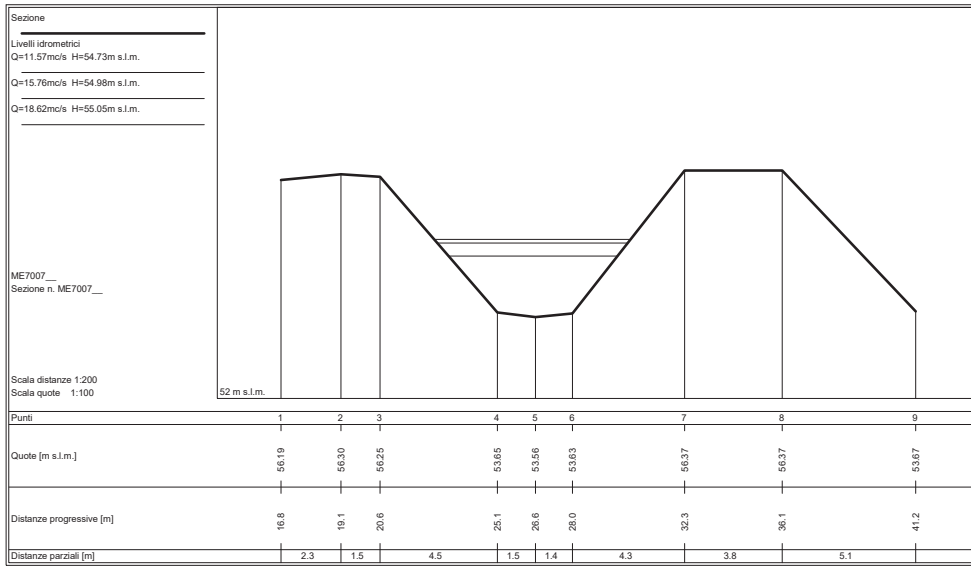

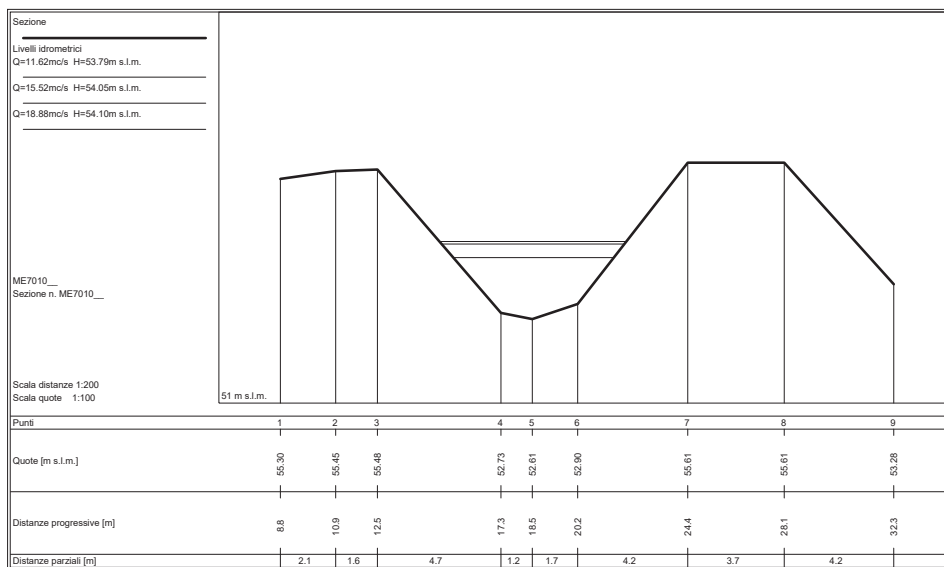
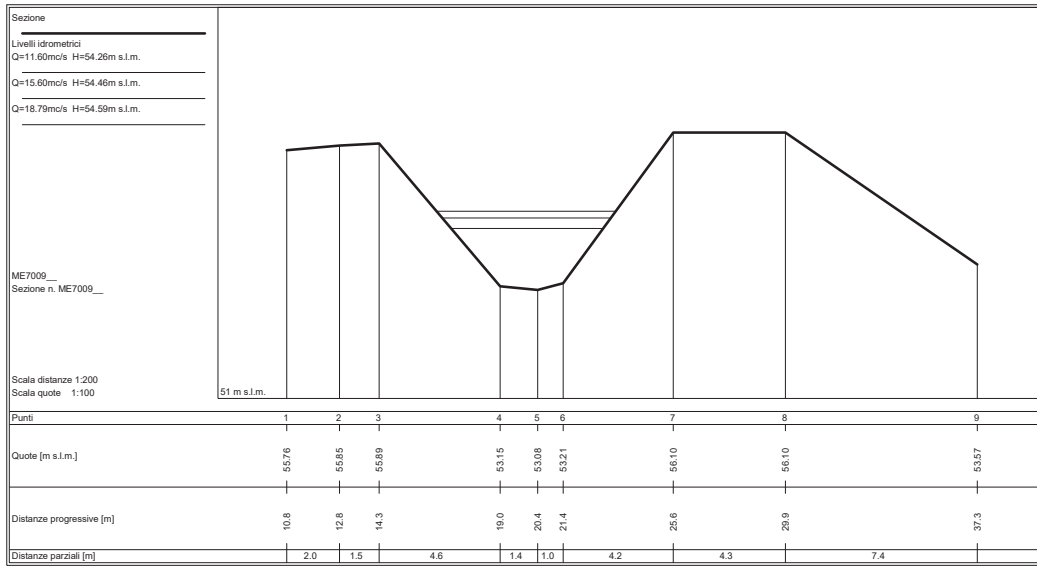

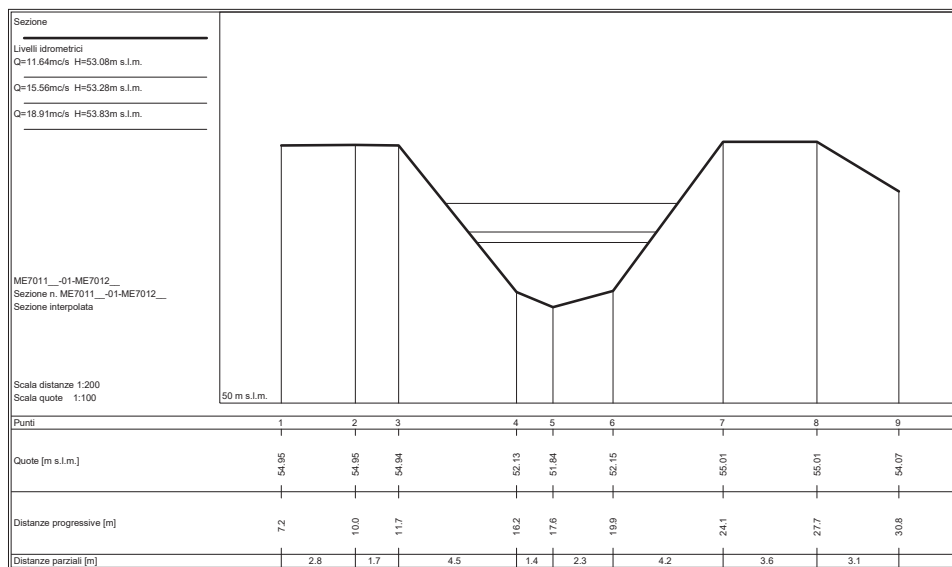
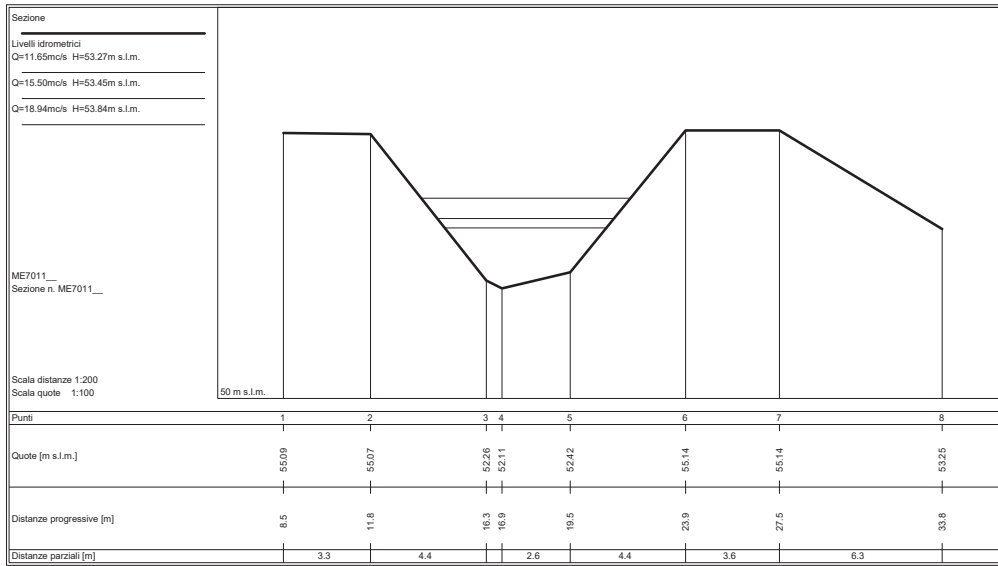

SEZIONI FLUVIALI  
FOSSO MENDACIONE - TRATTO 1



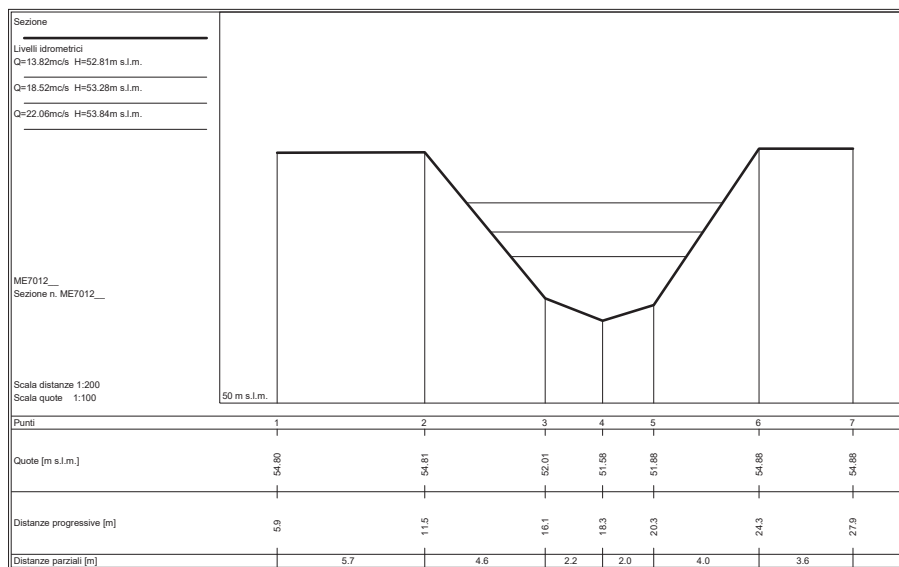
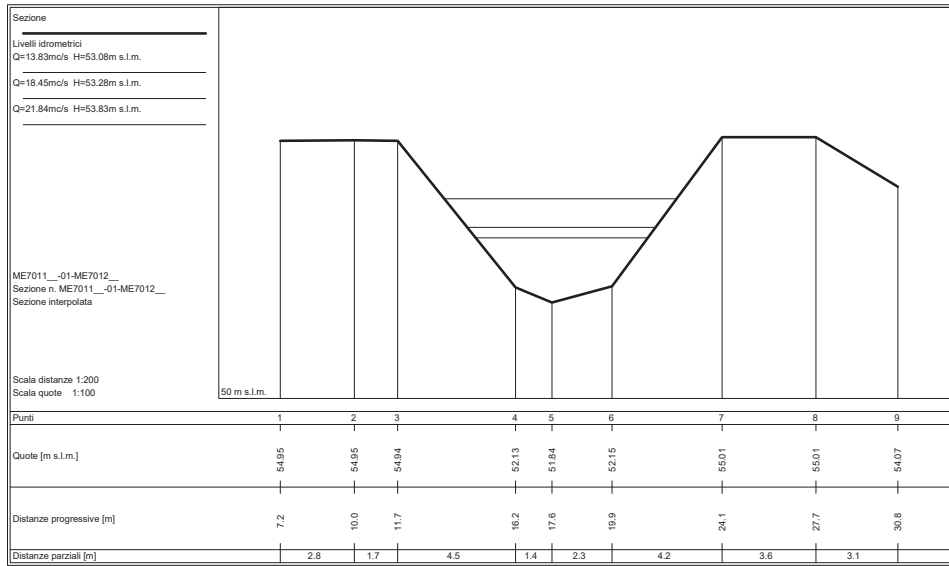

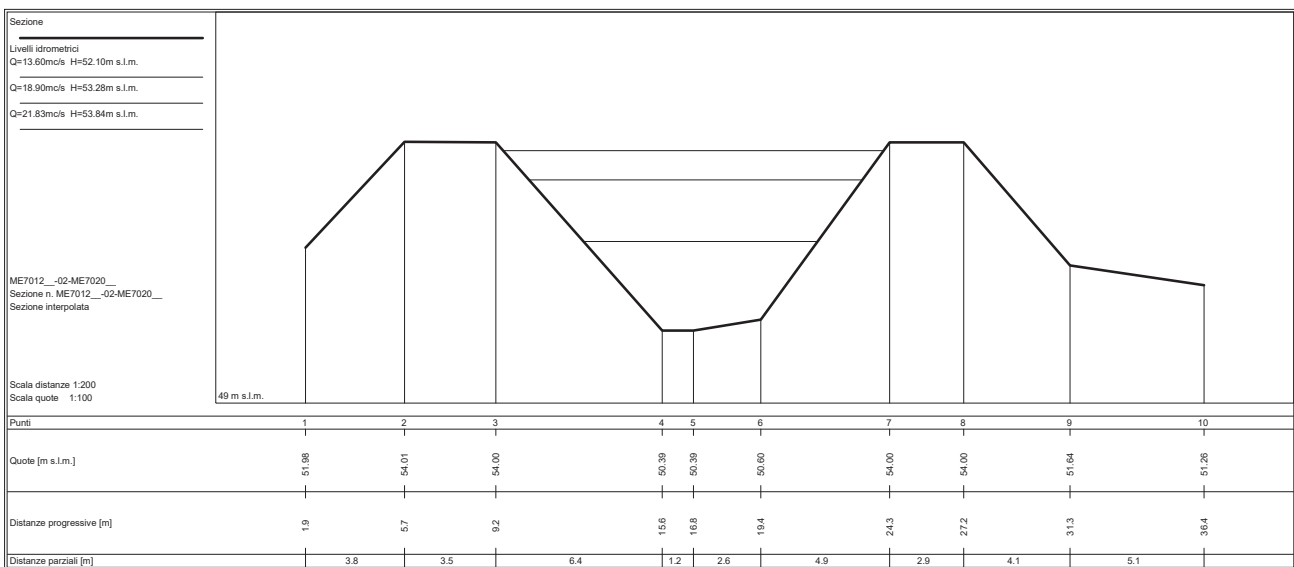
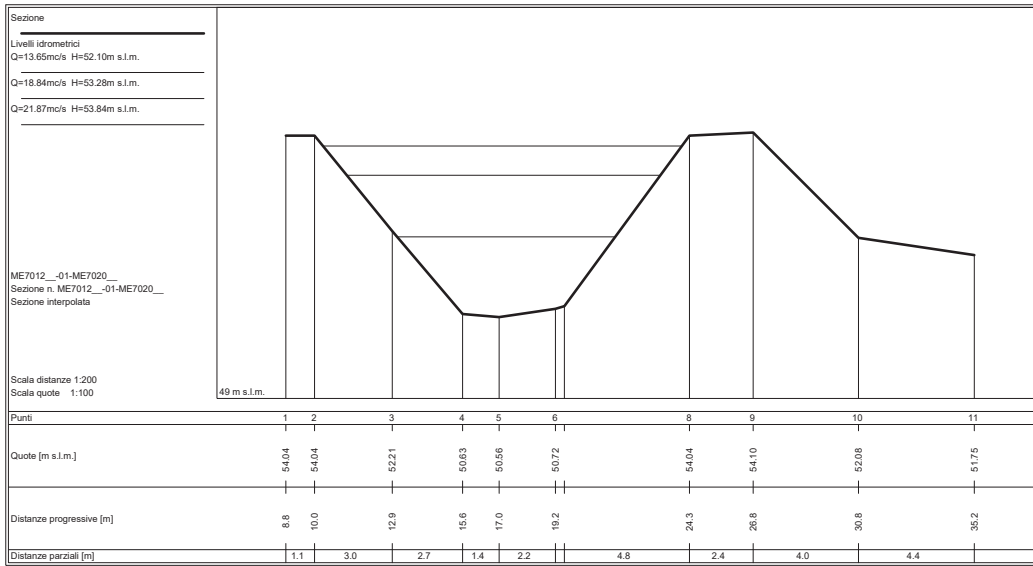

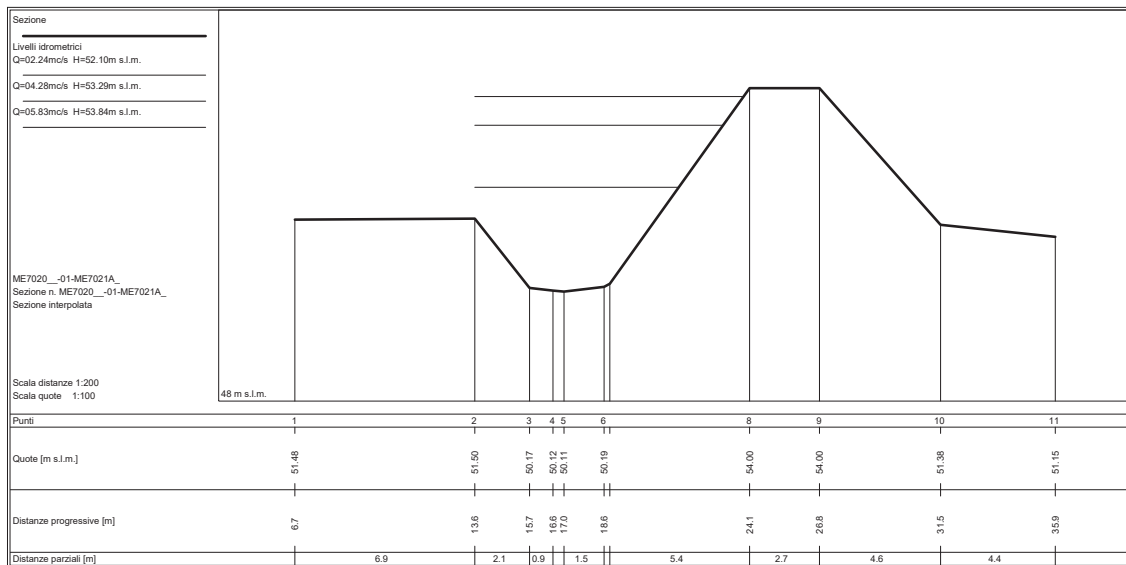
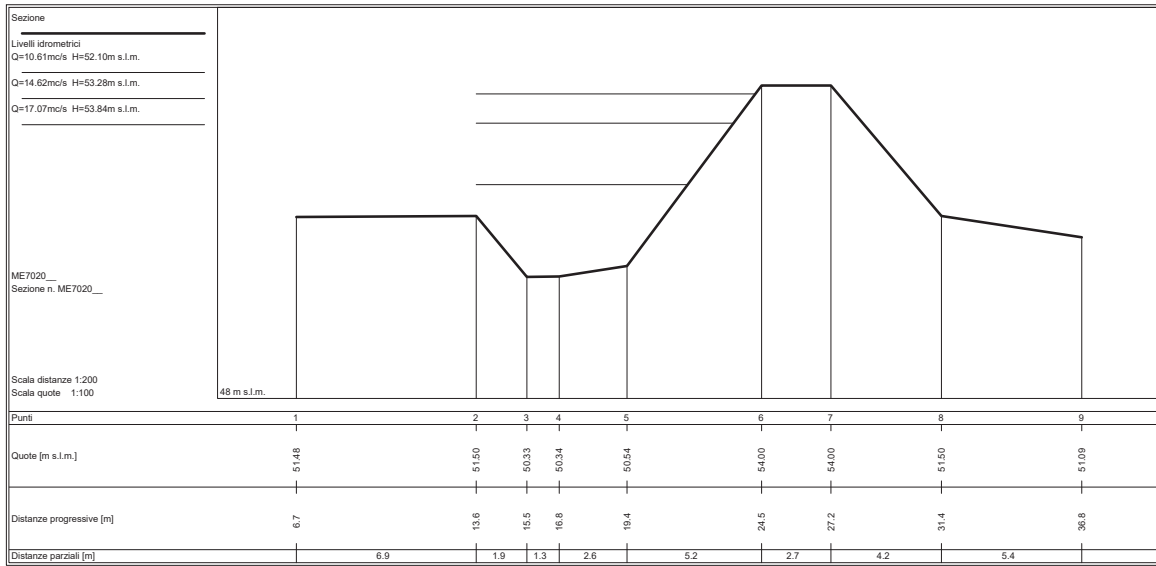

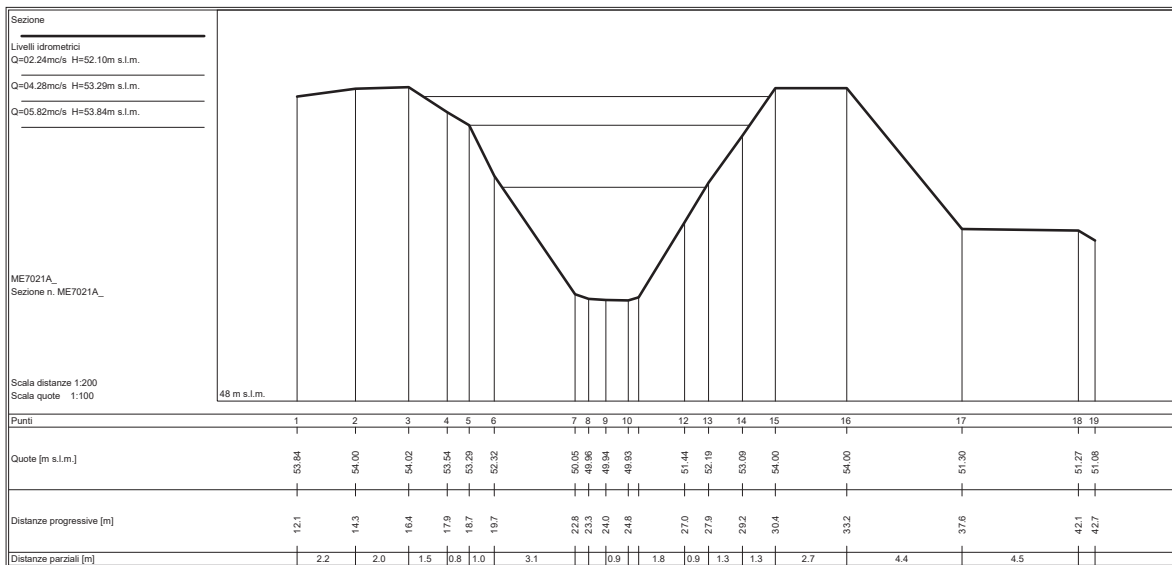
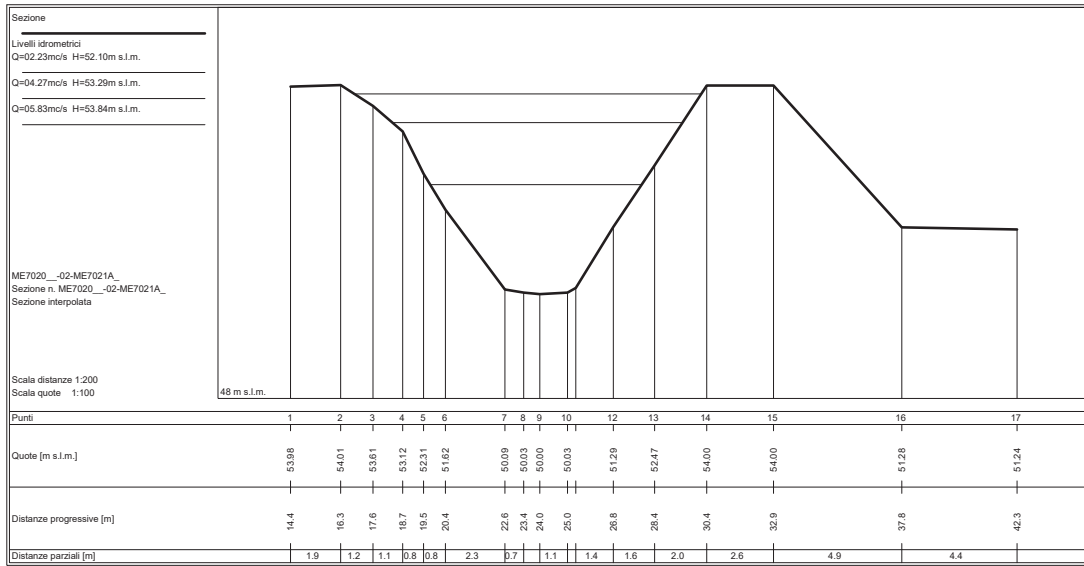

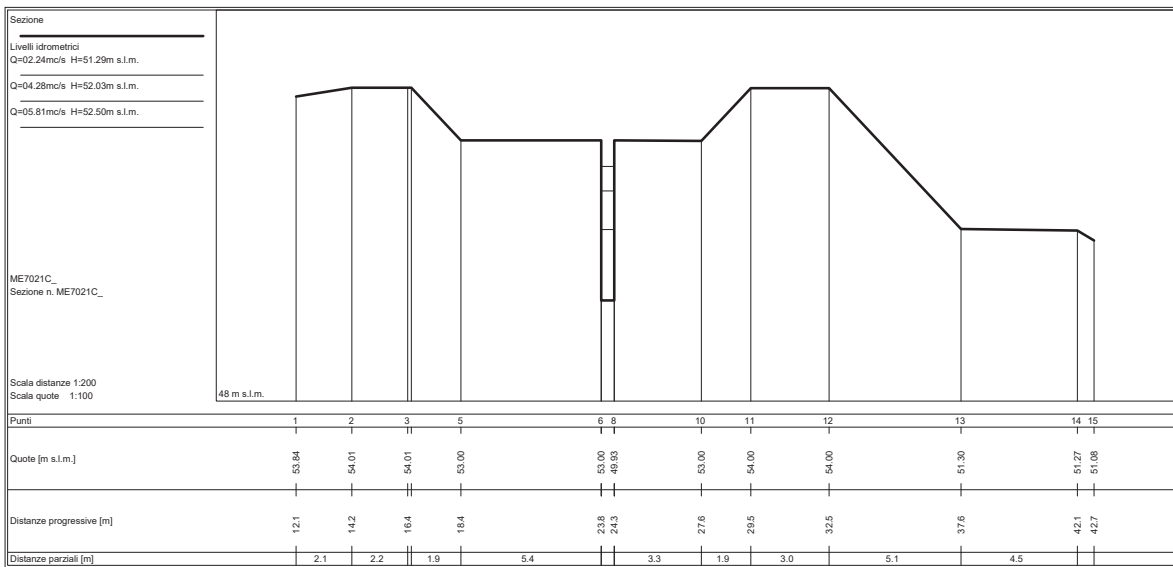
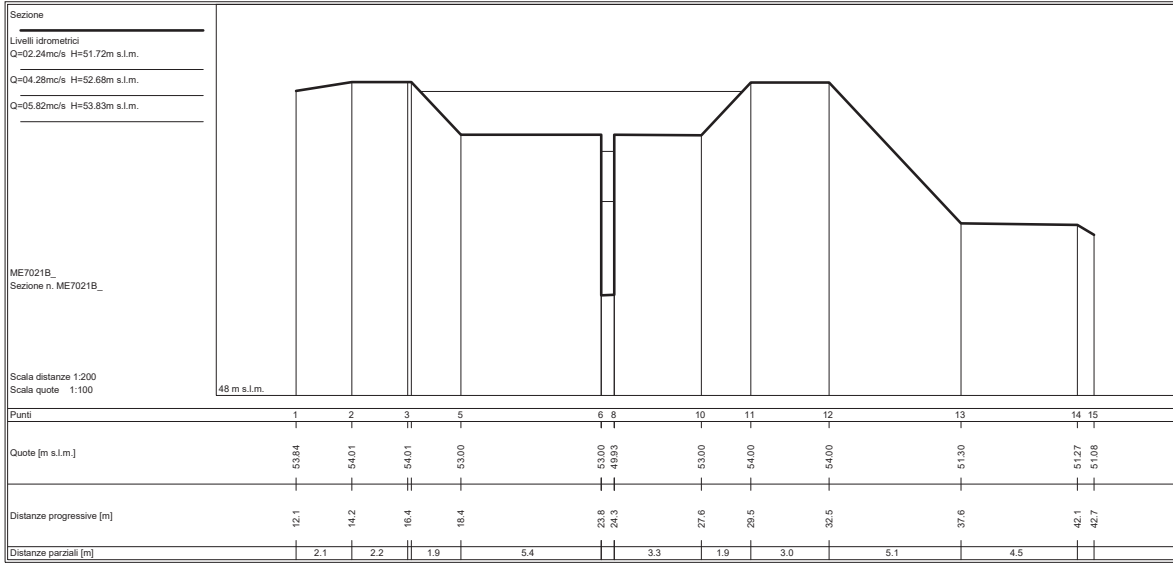

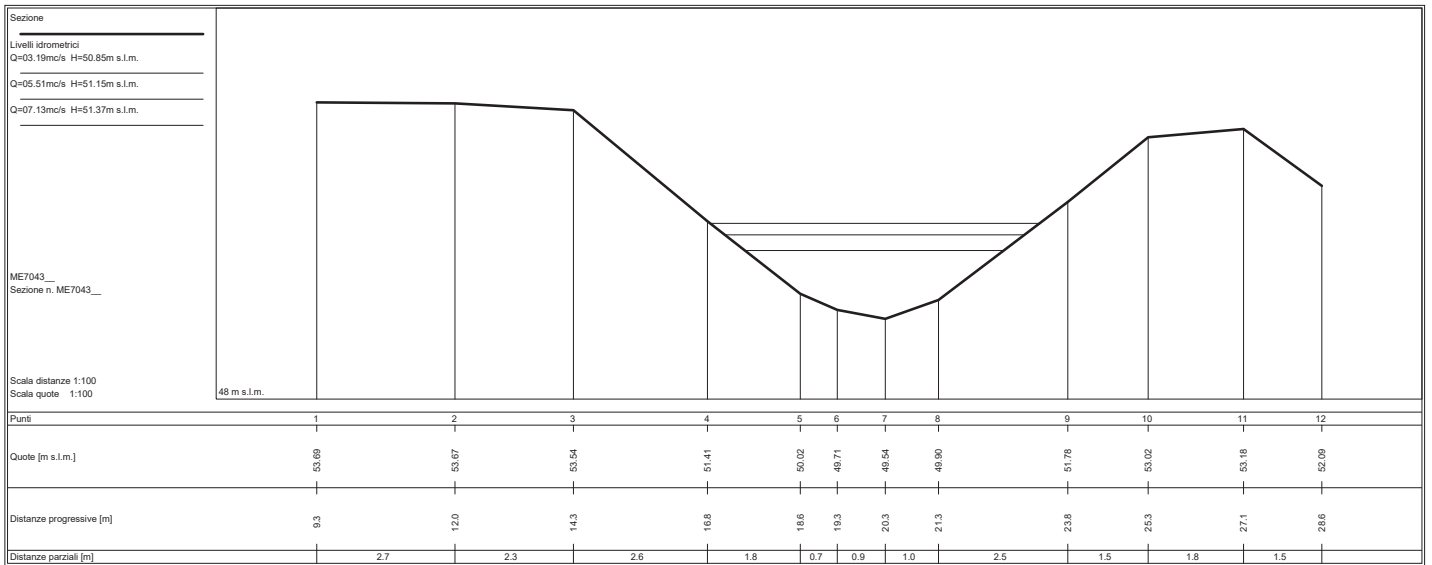
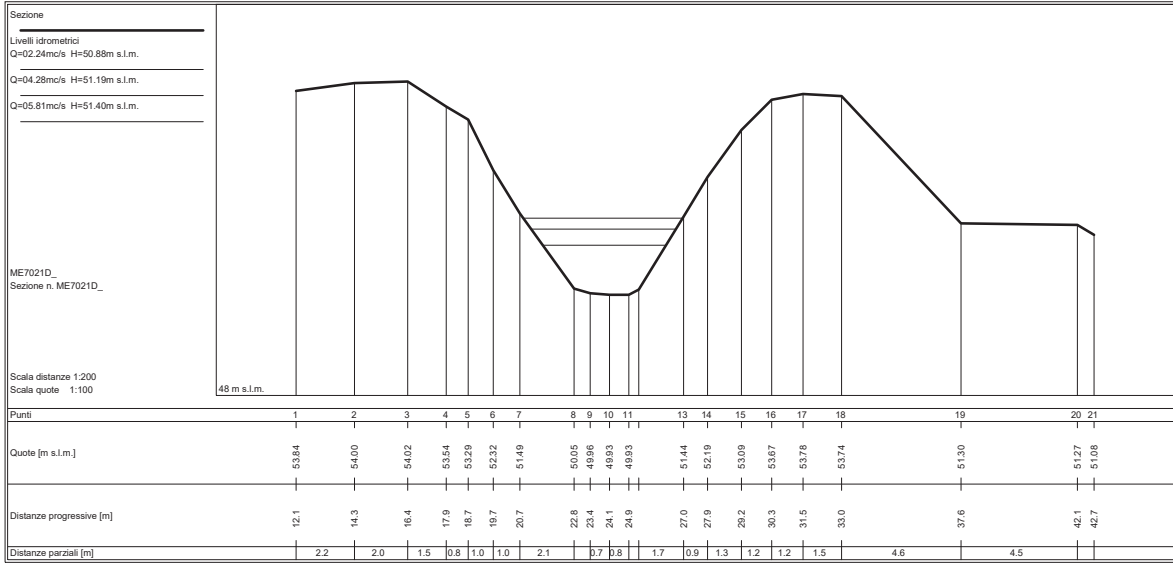

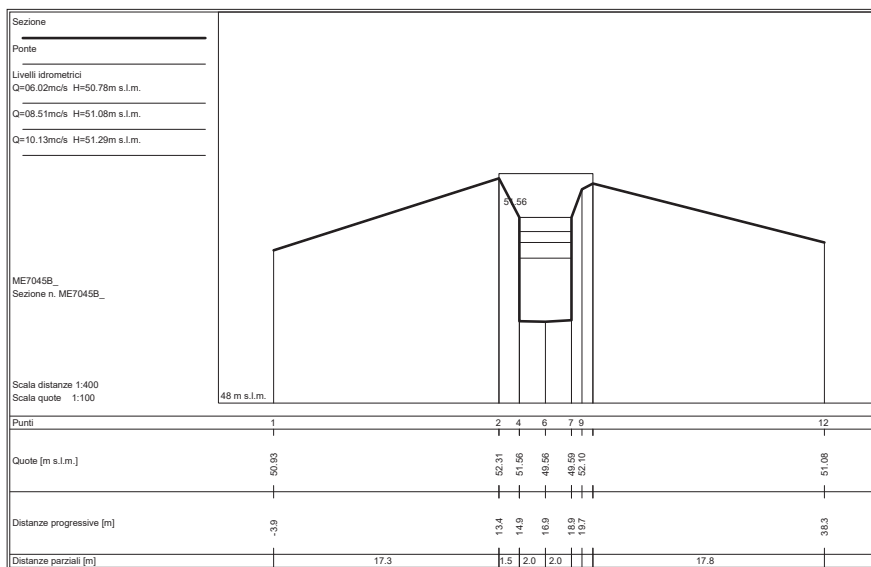
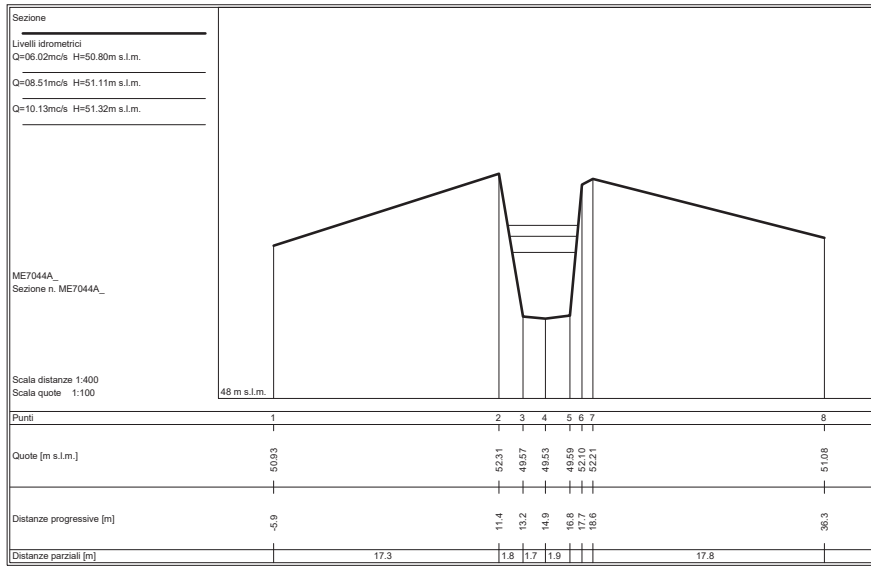

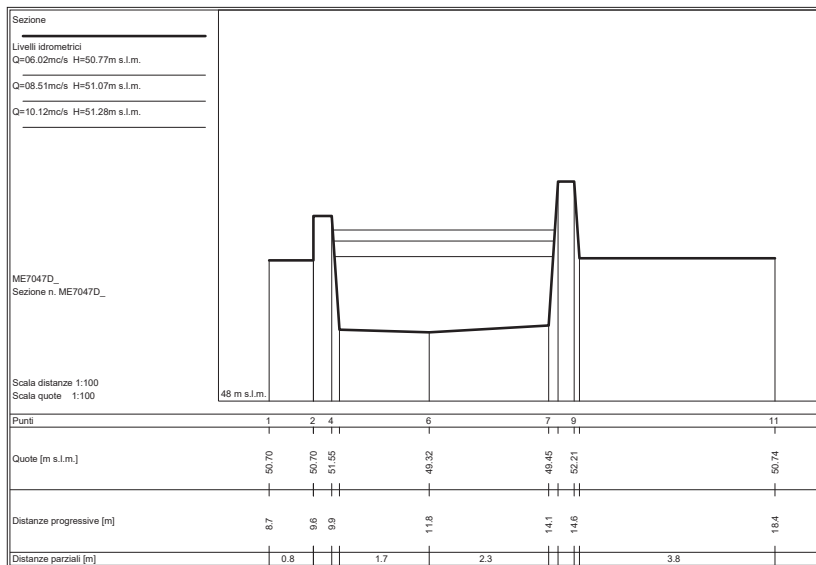
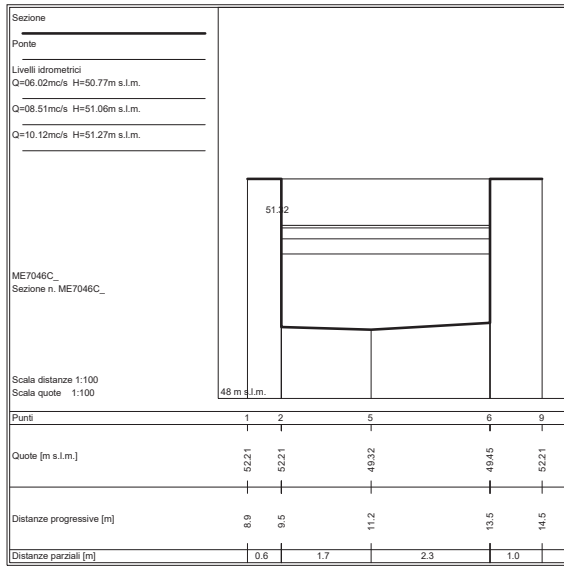



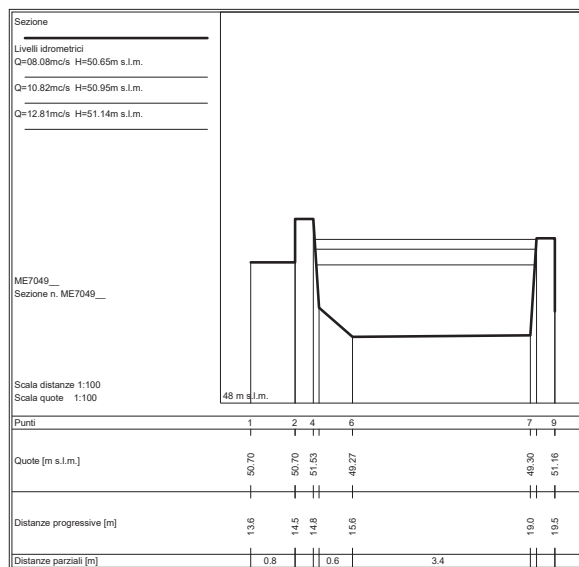
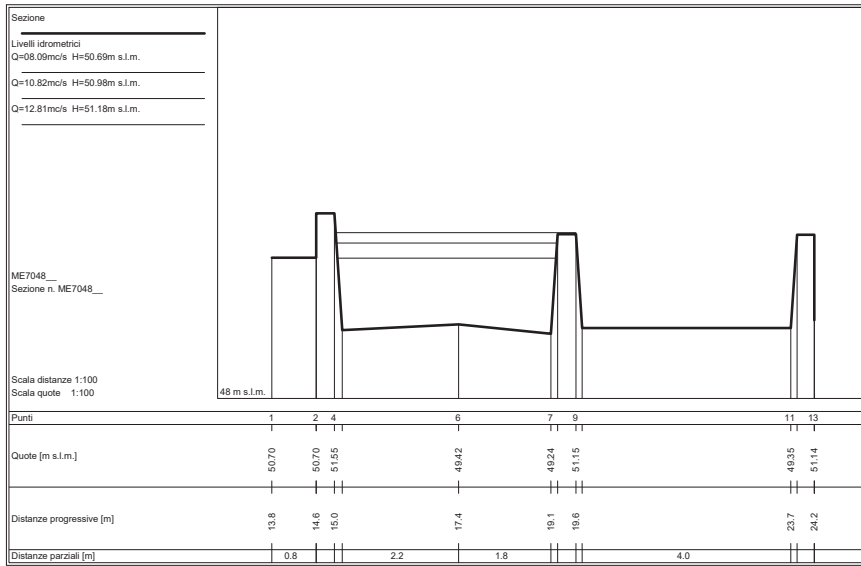

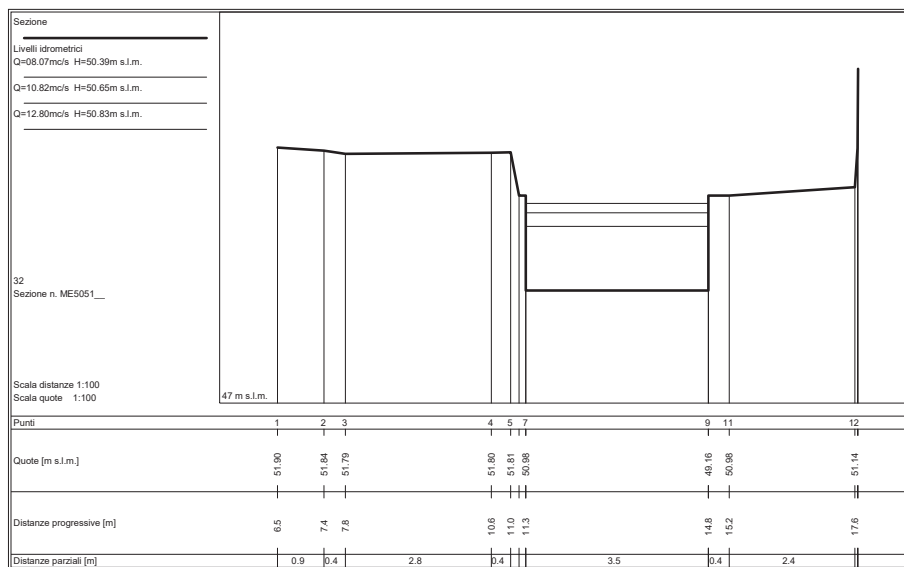
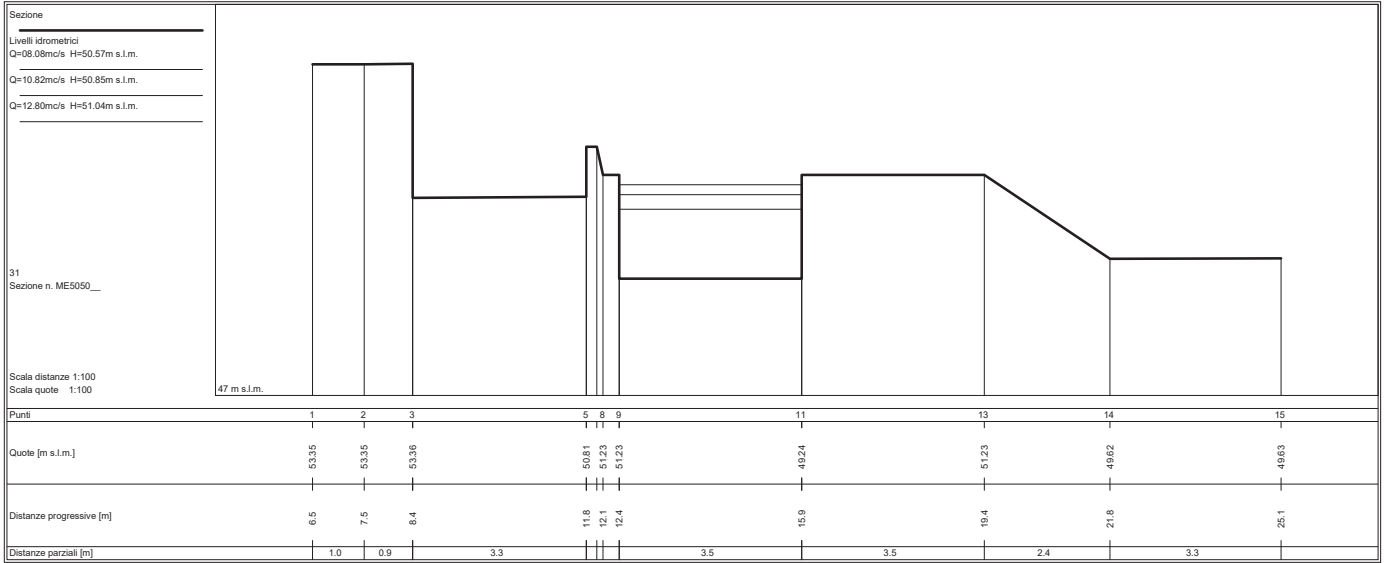

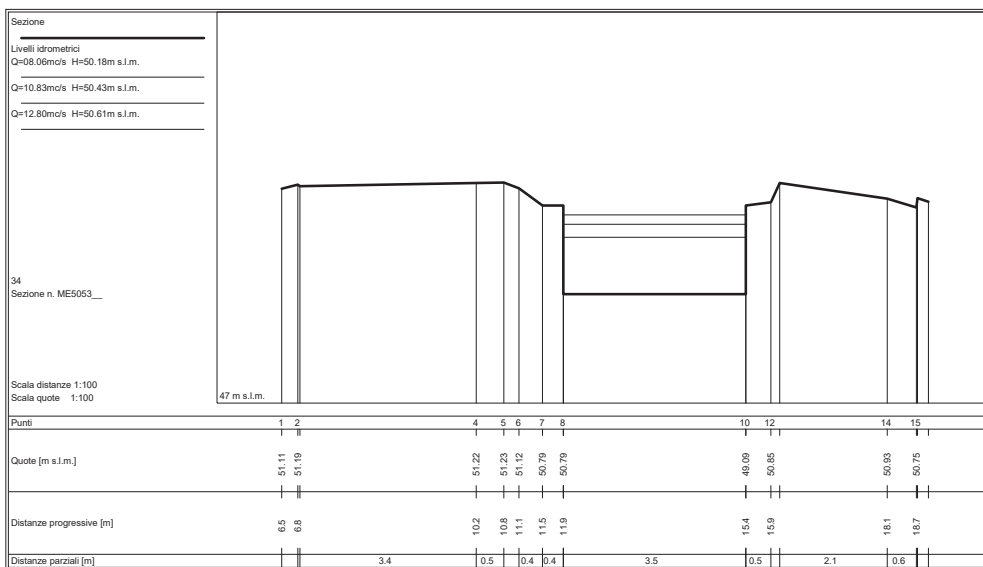
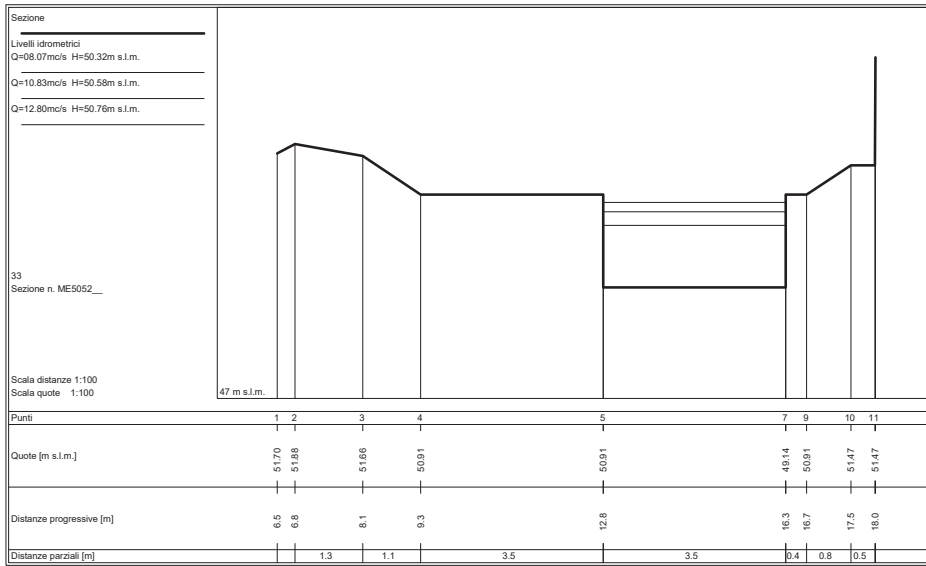

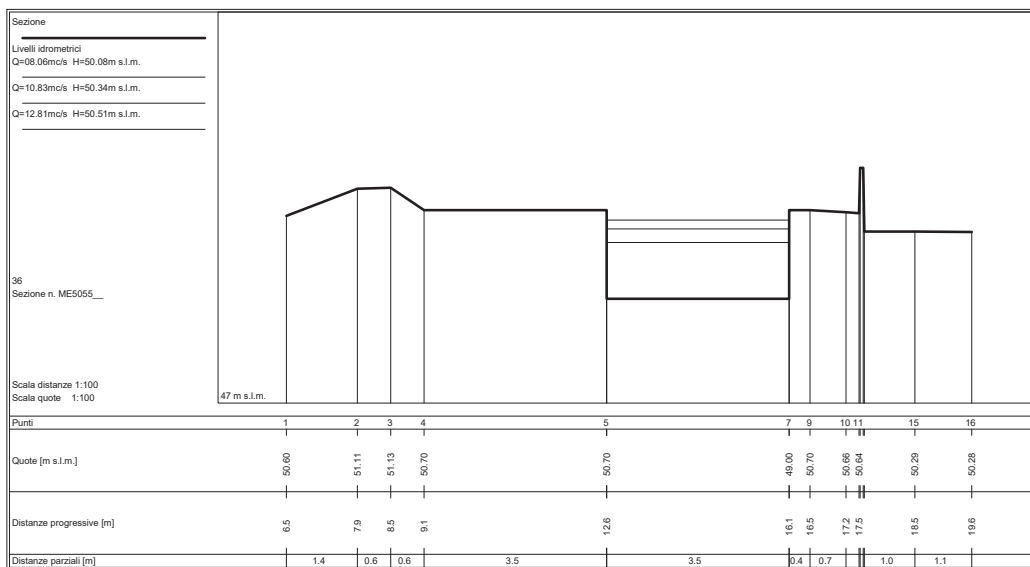
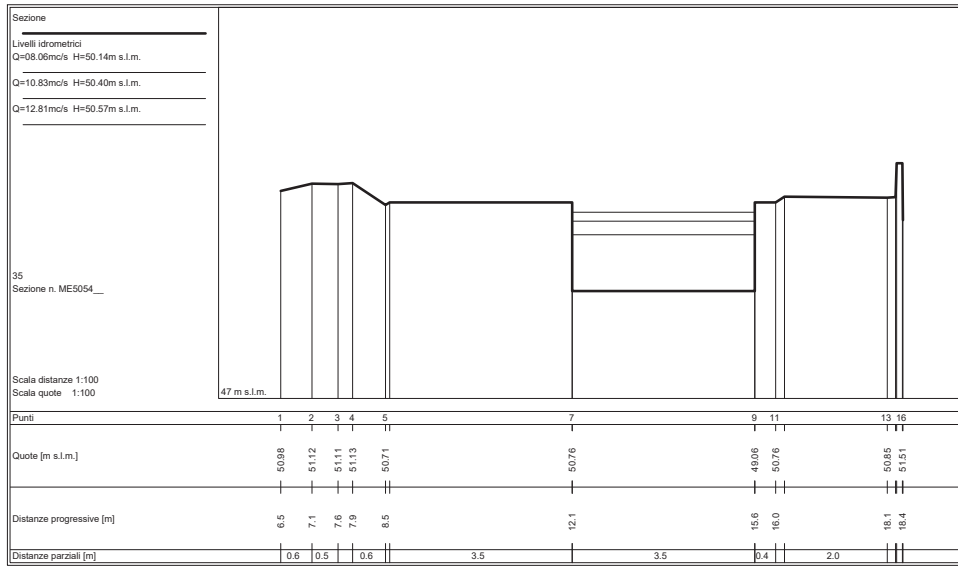

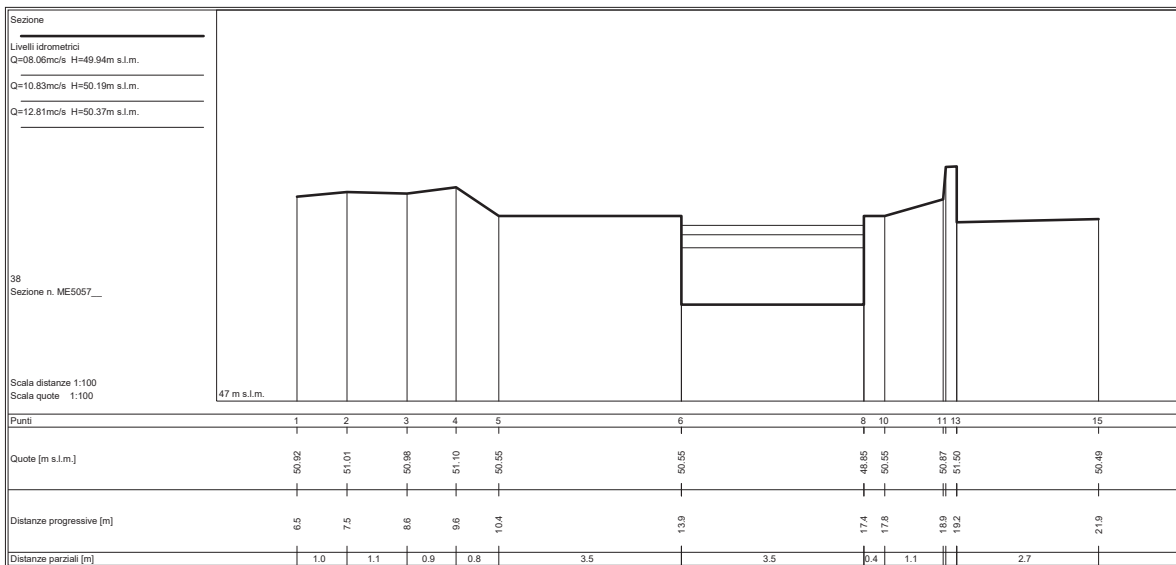
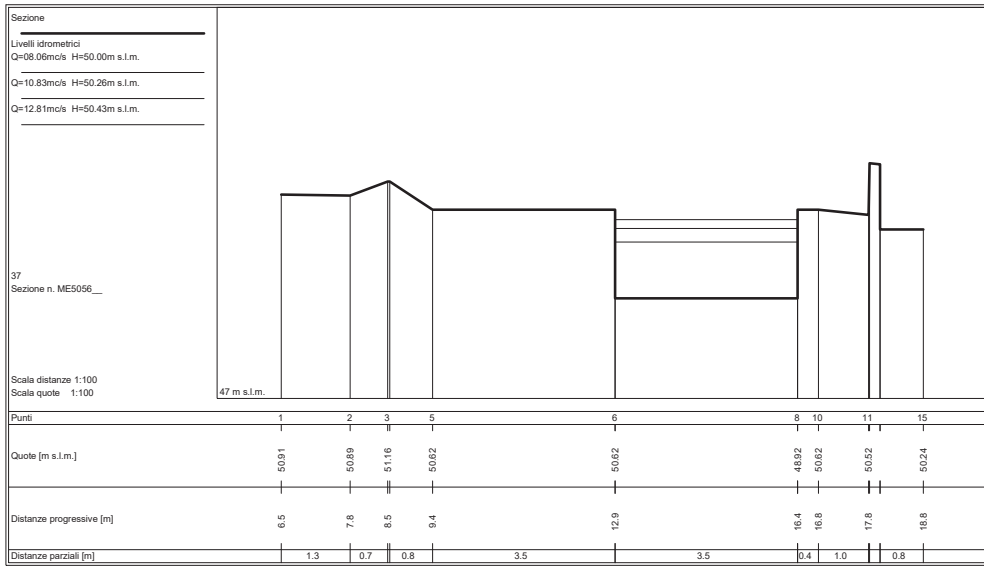

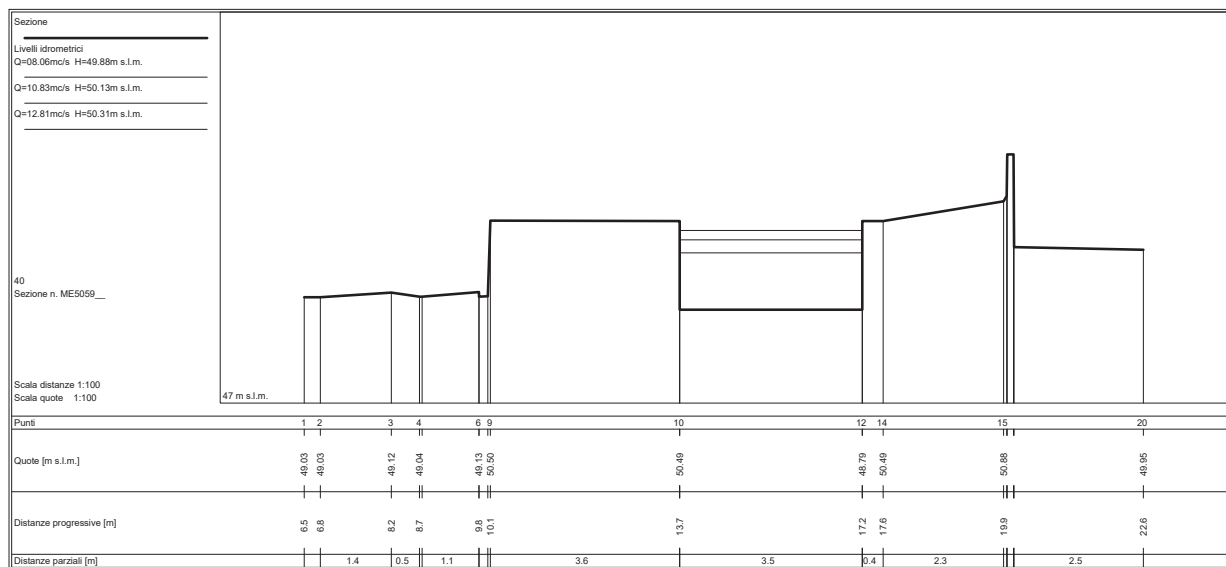
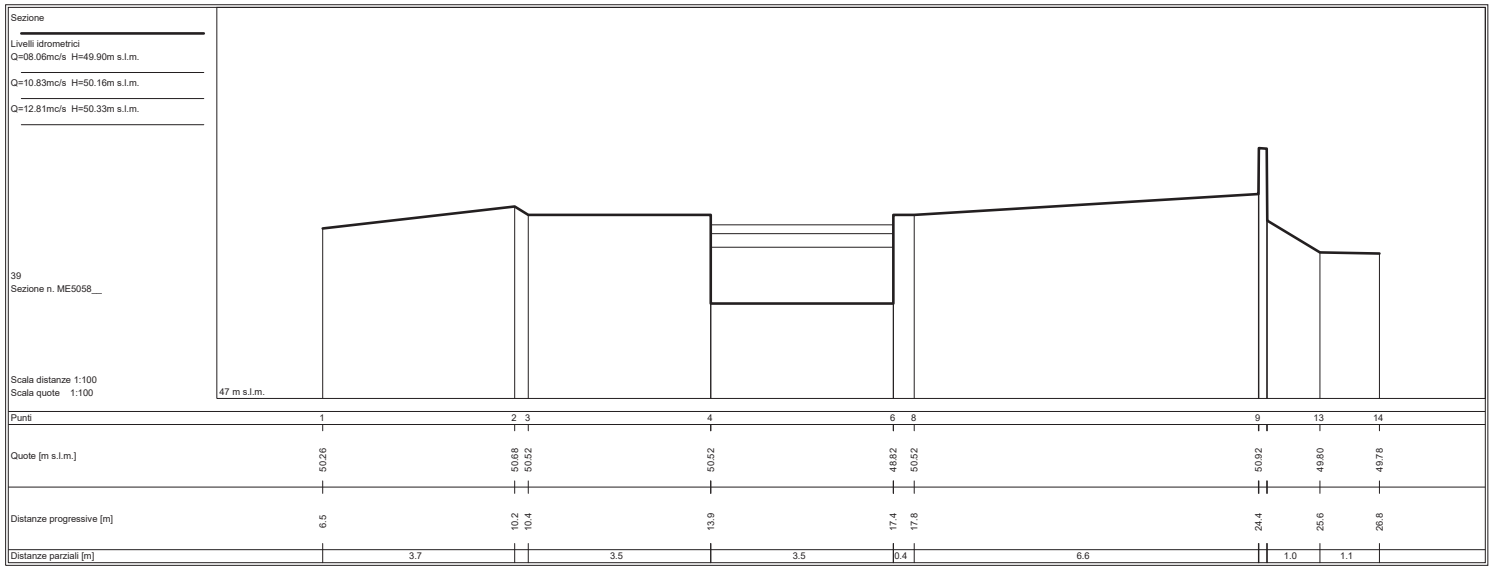

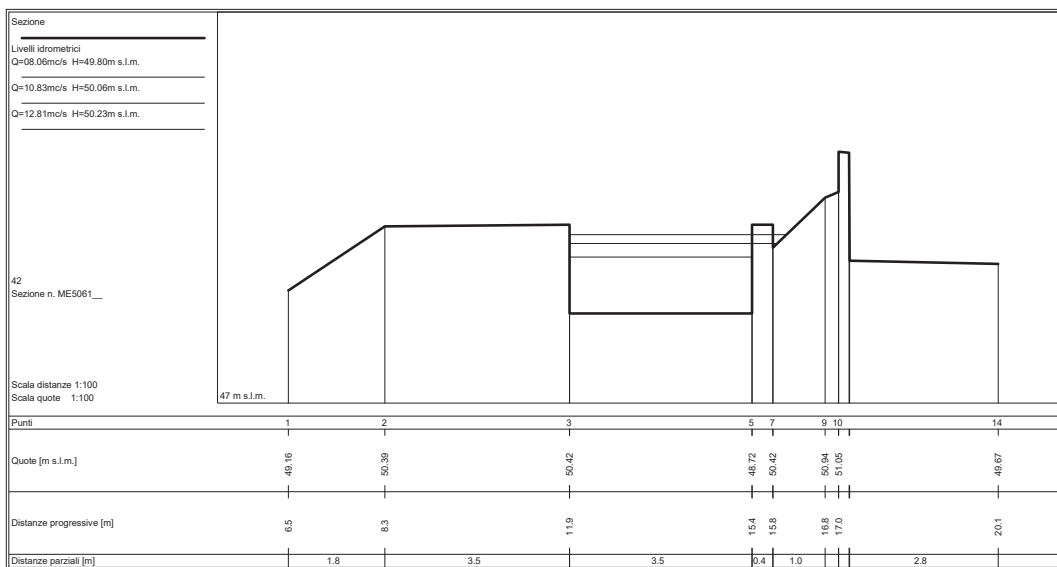
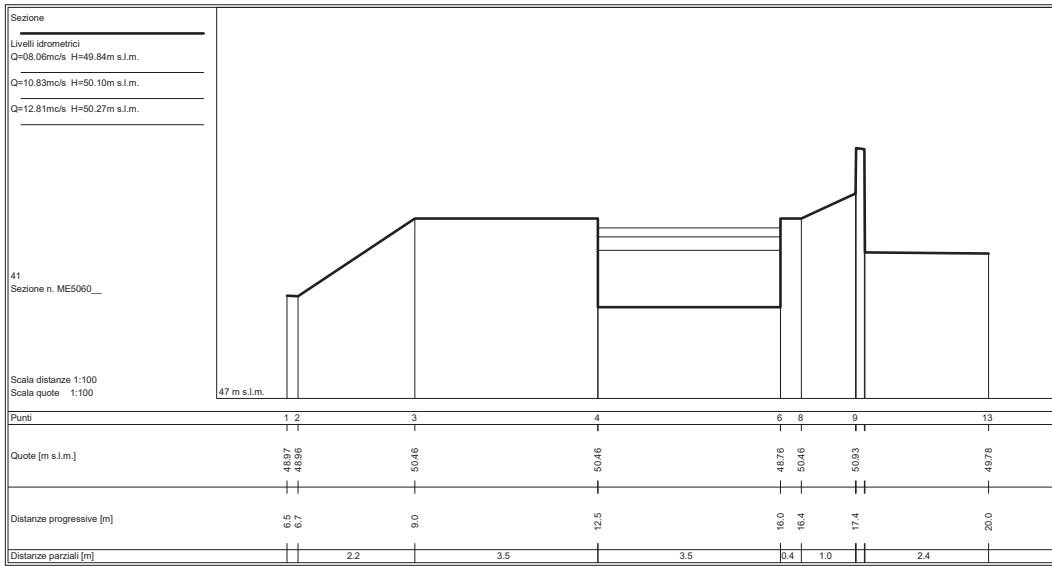

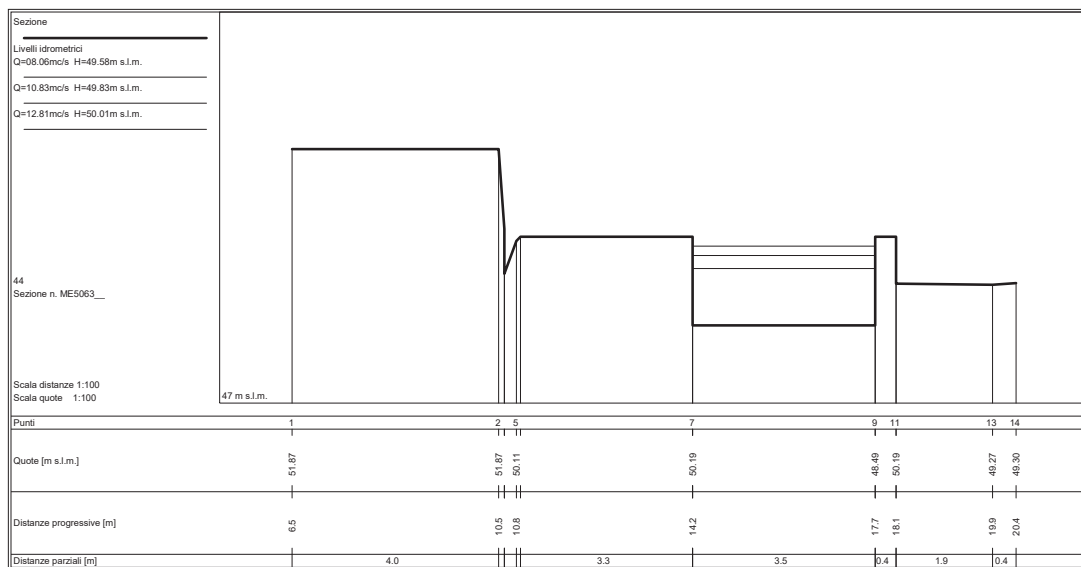
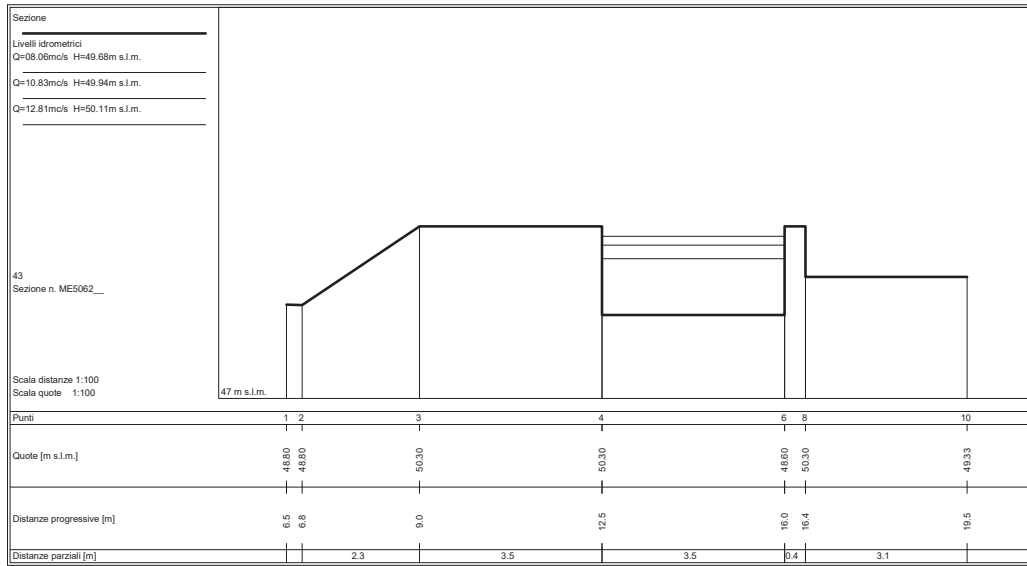



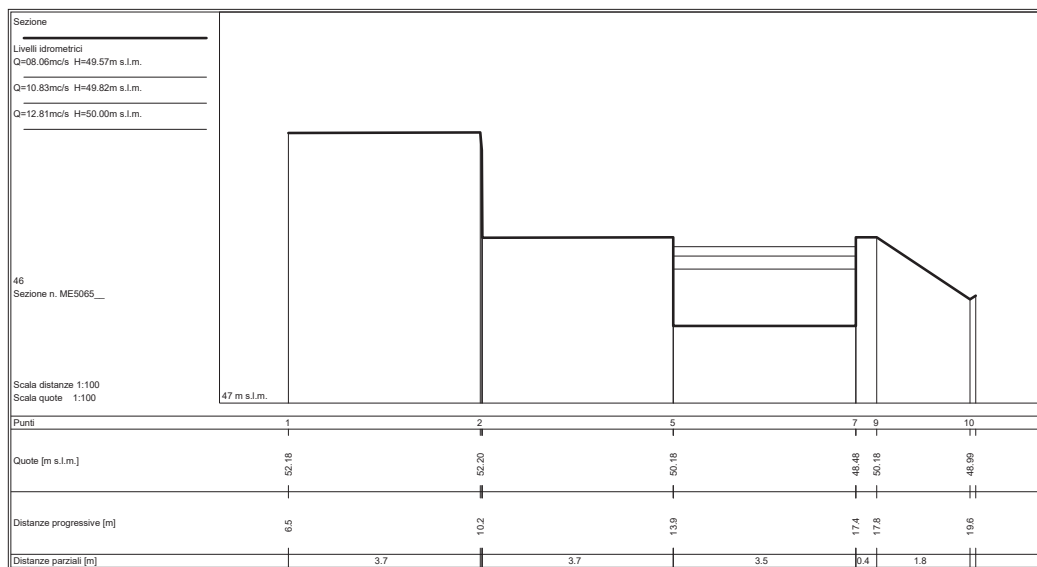
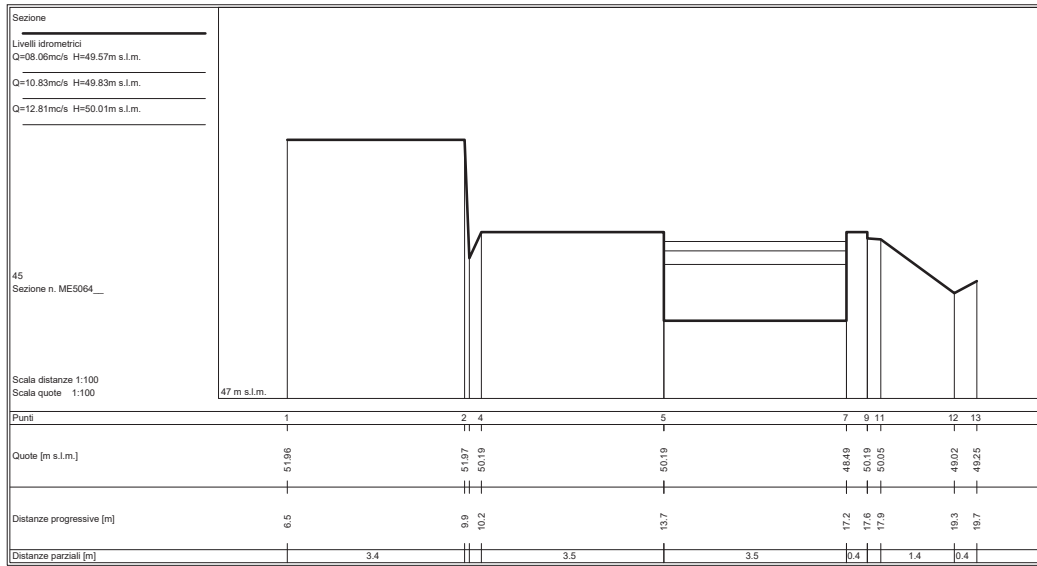

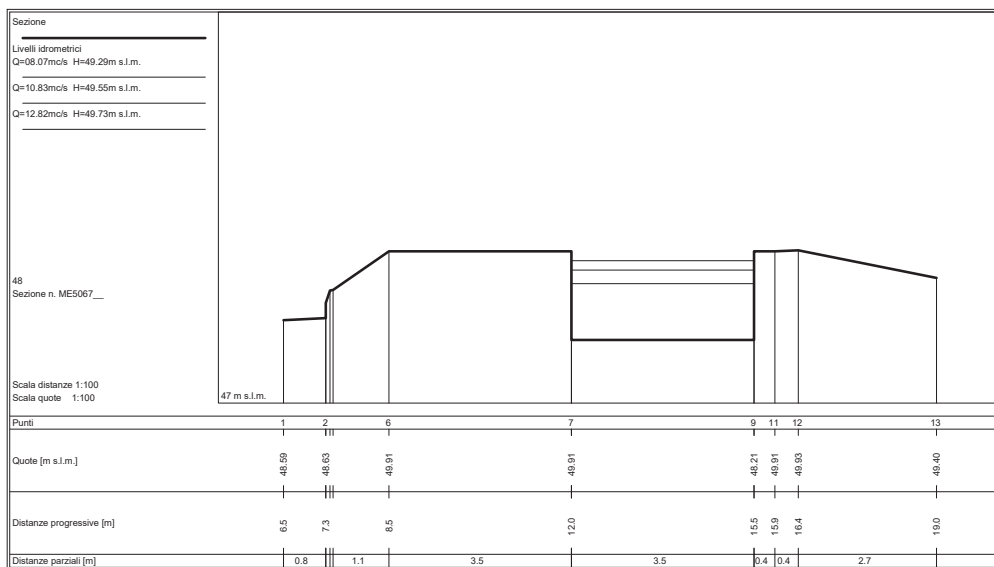
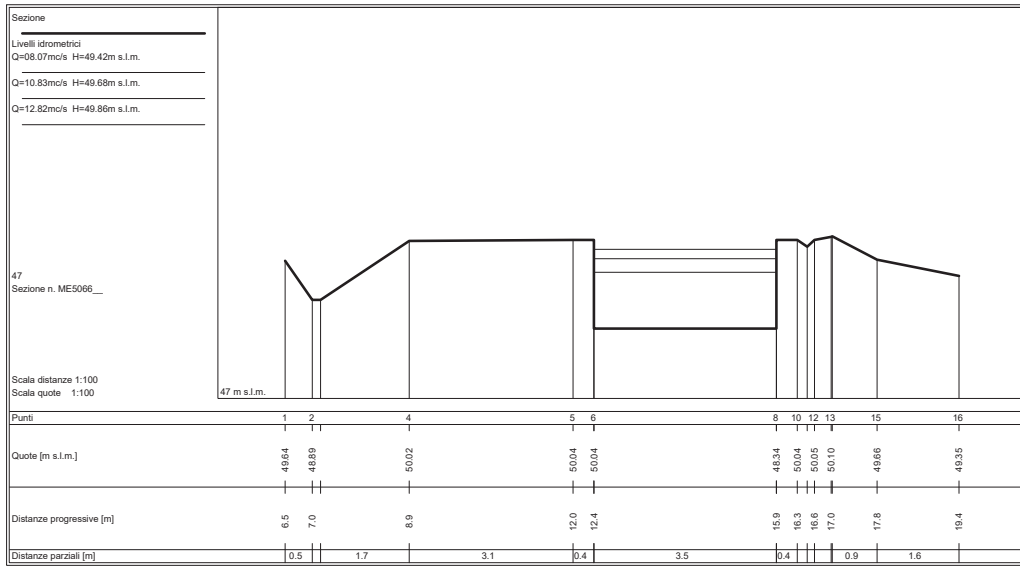

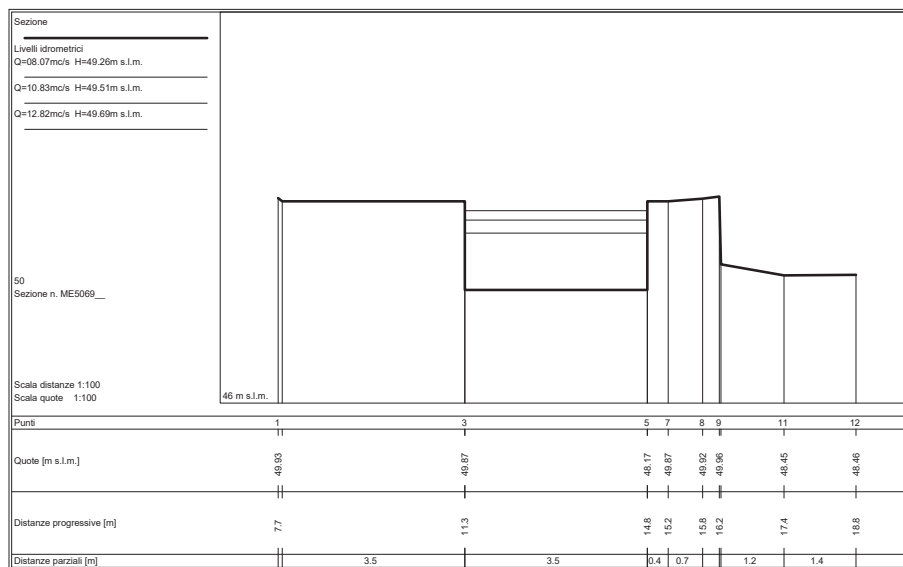
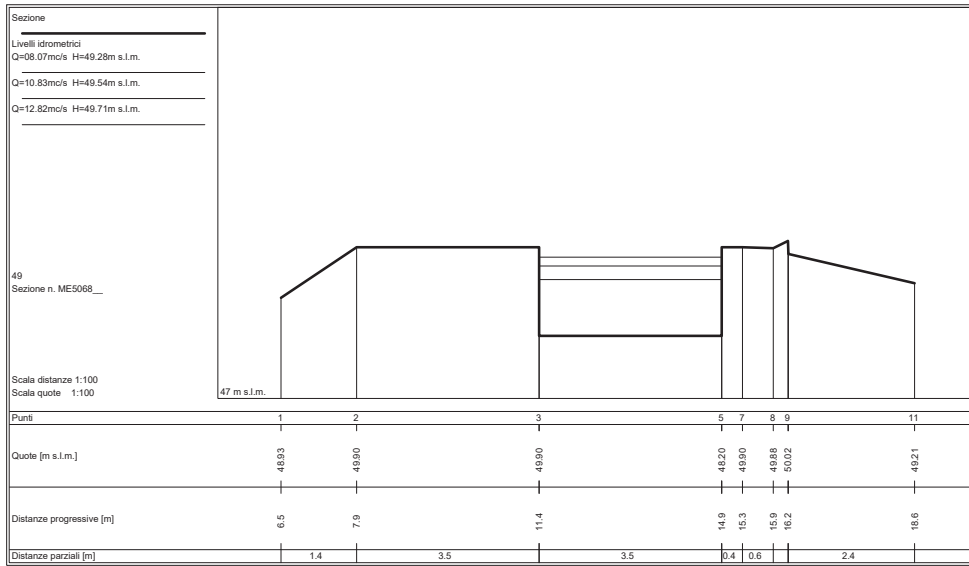

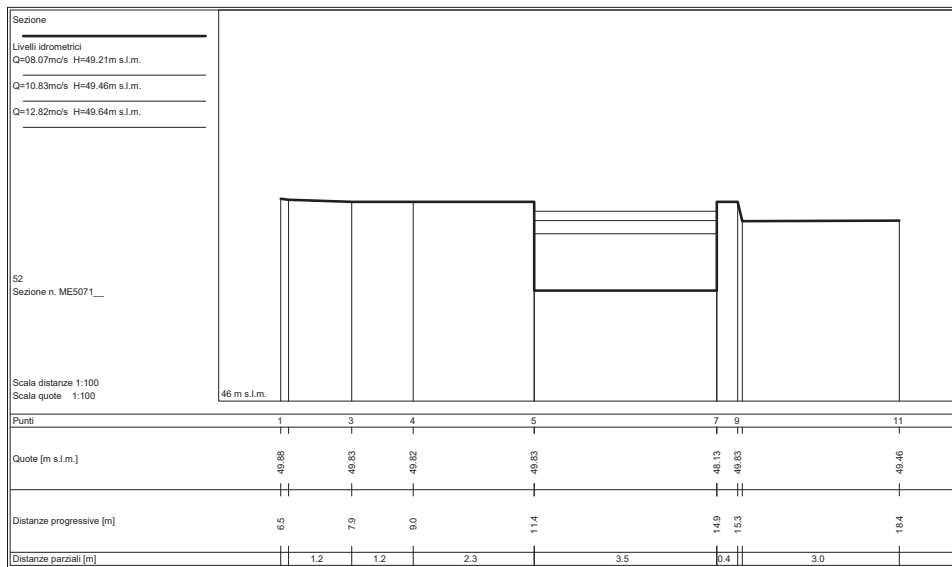
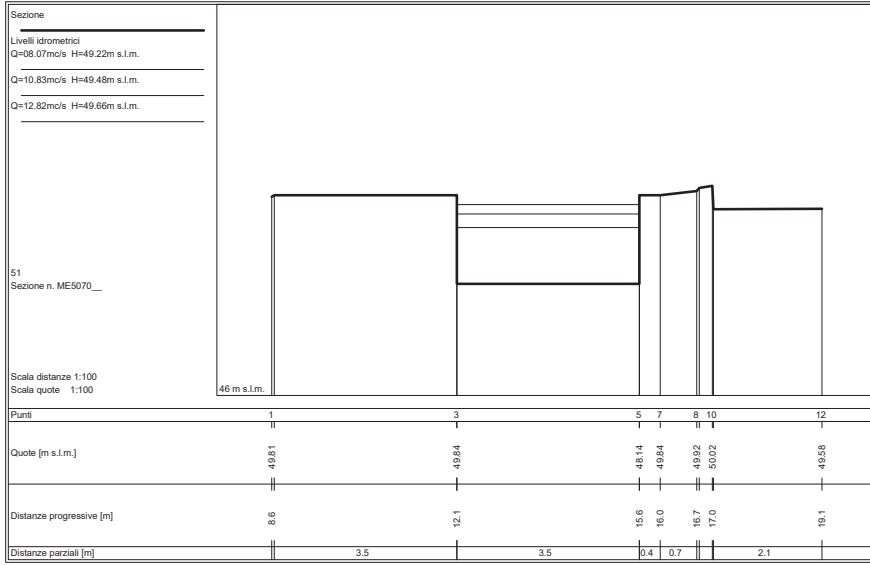

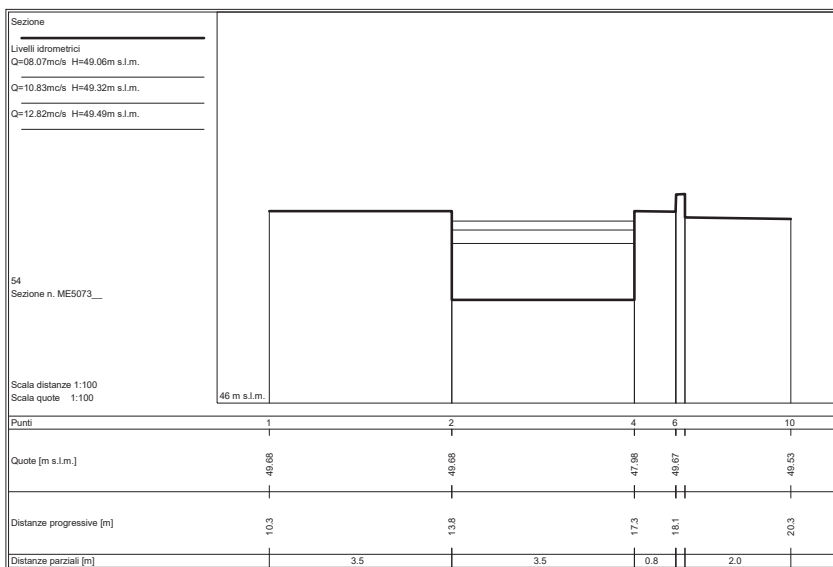
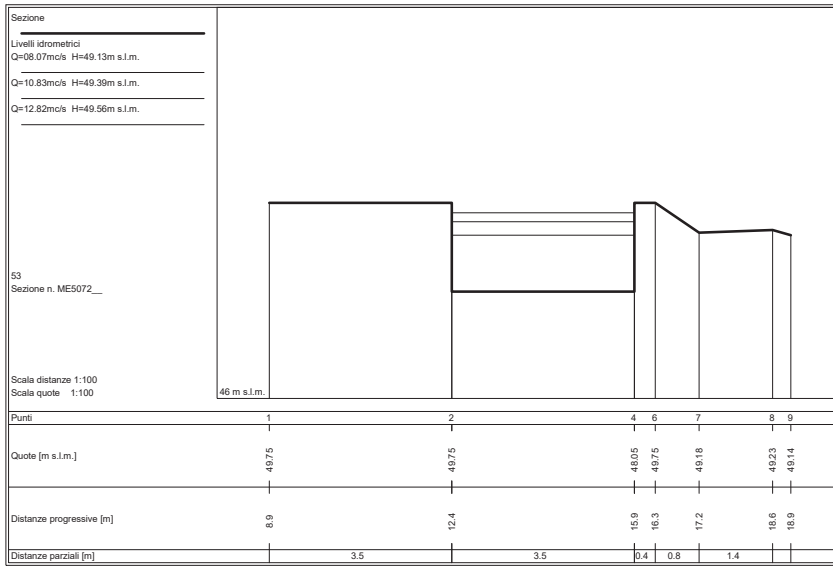

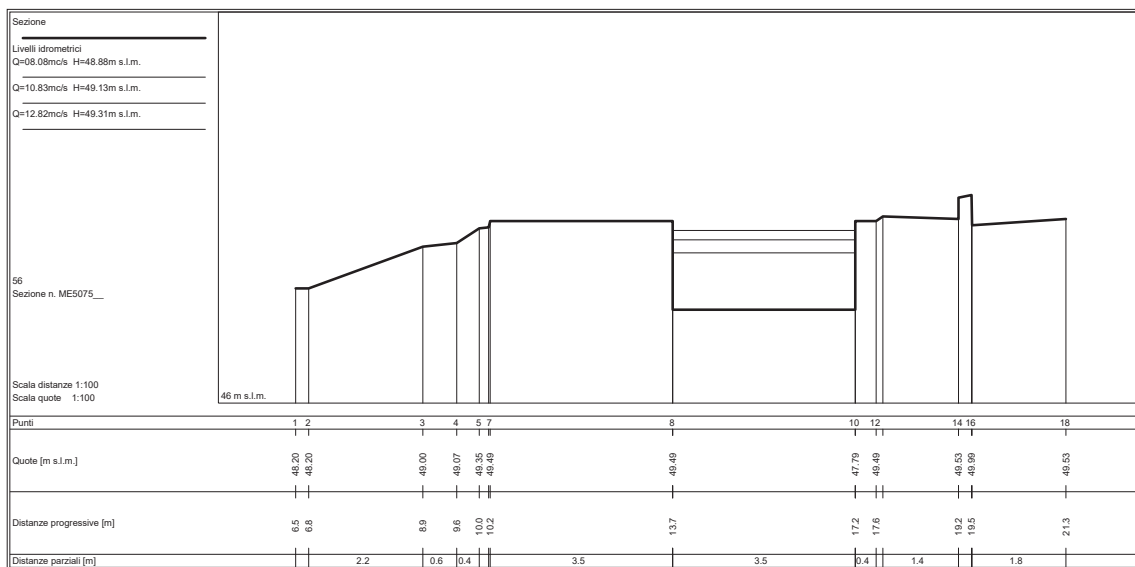
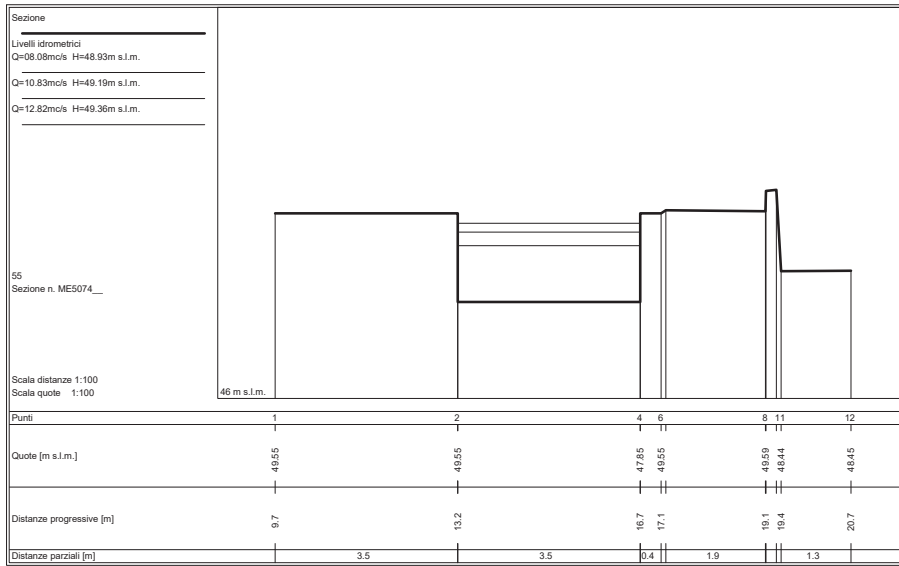

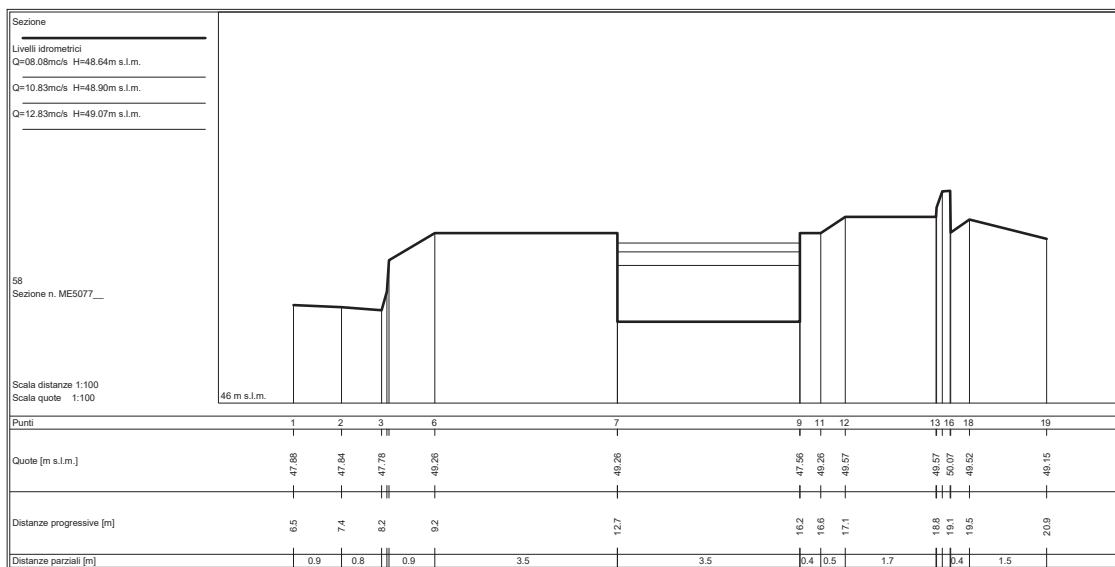
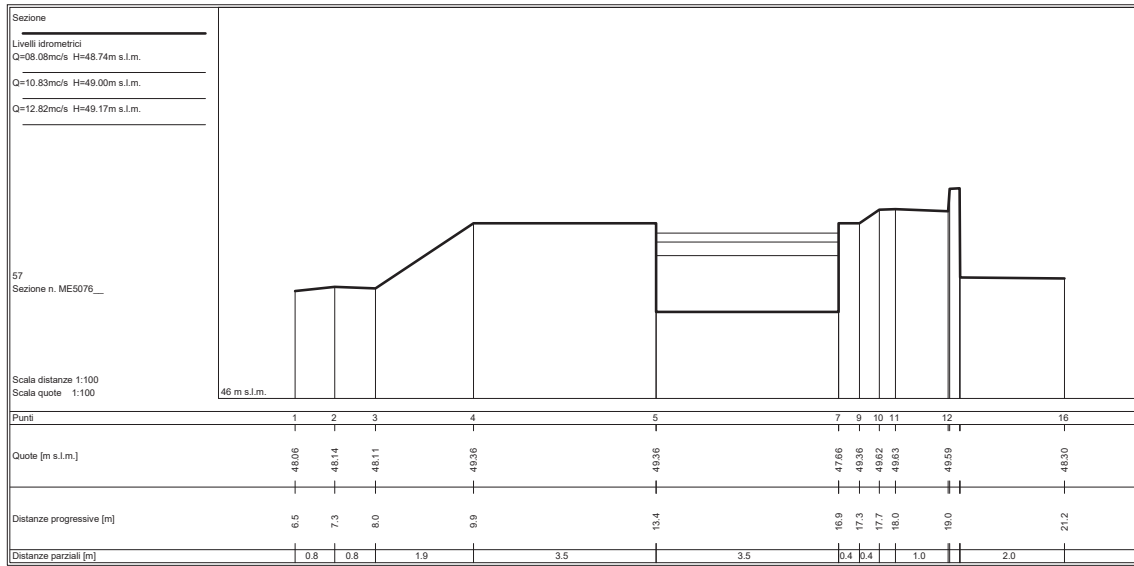

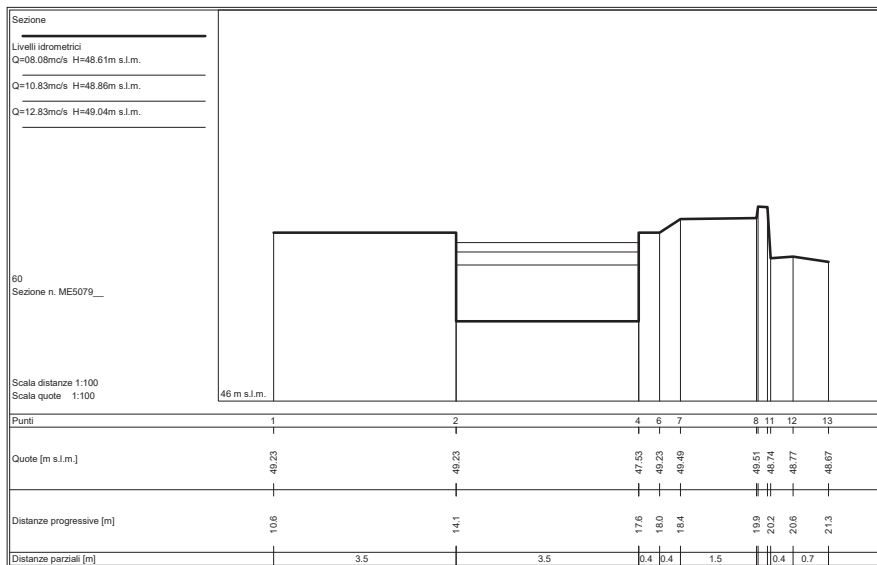
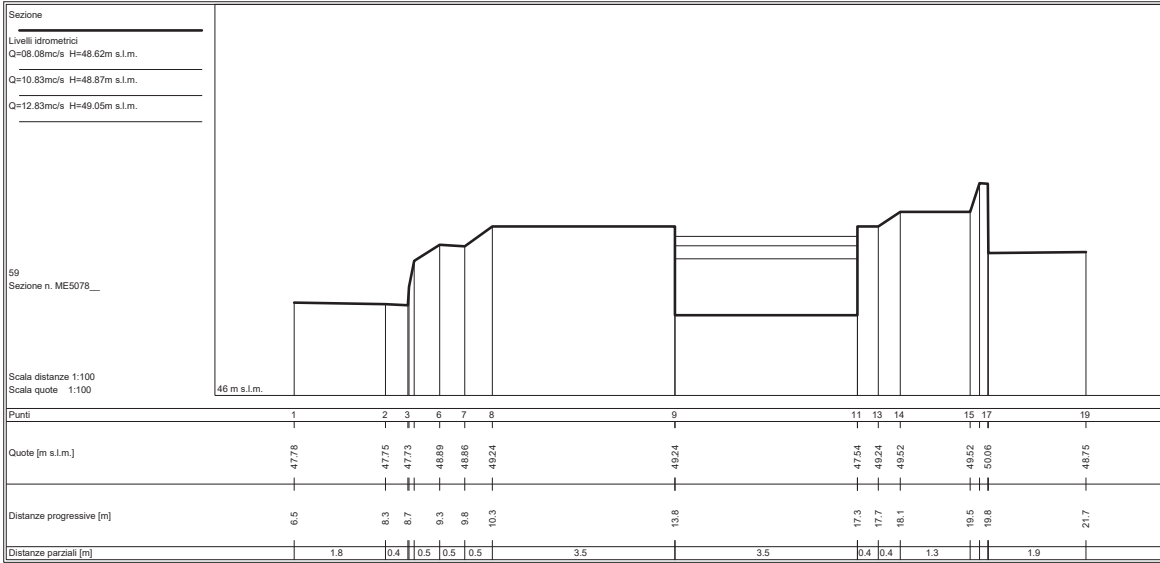



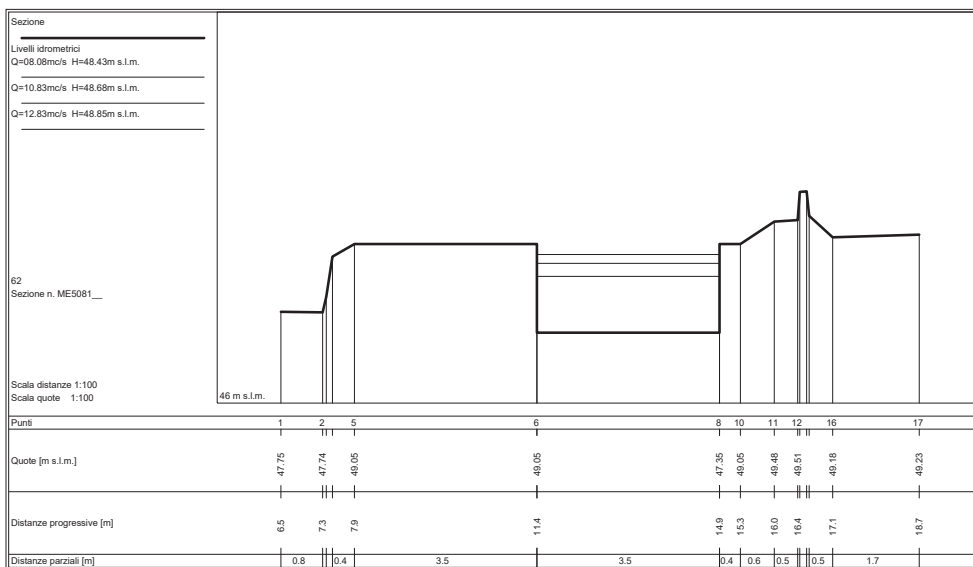
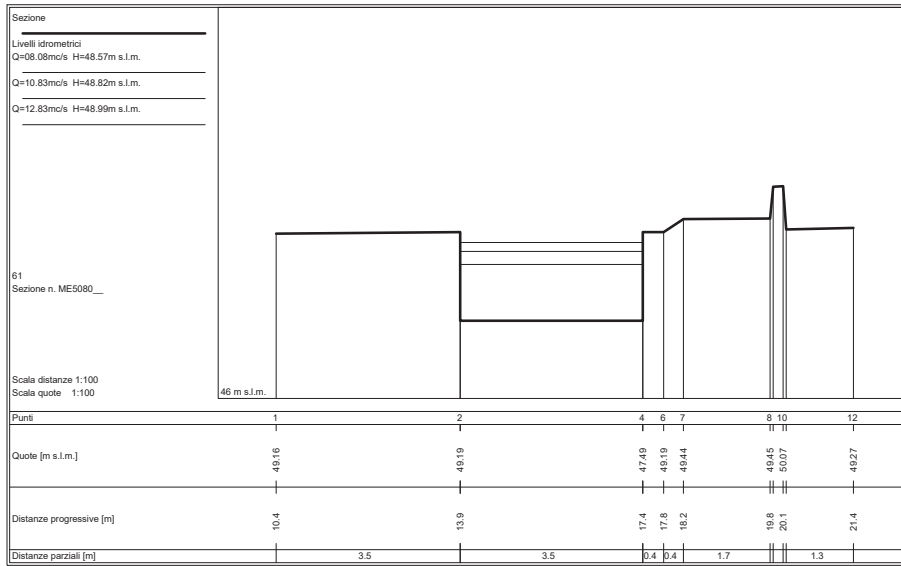

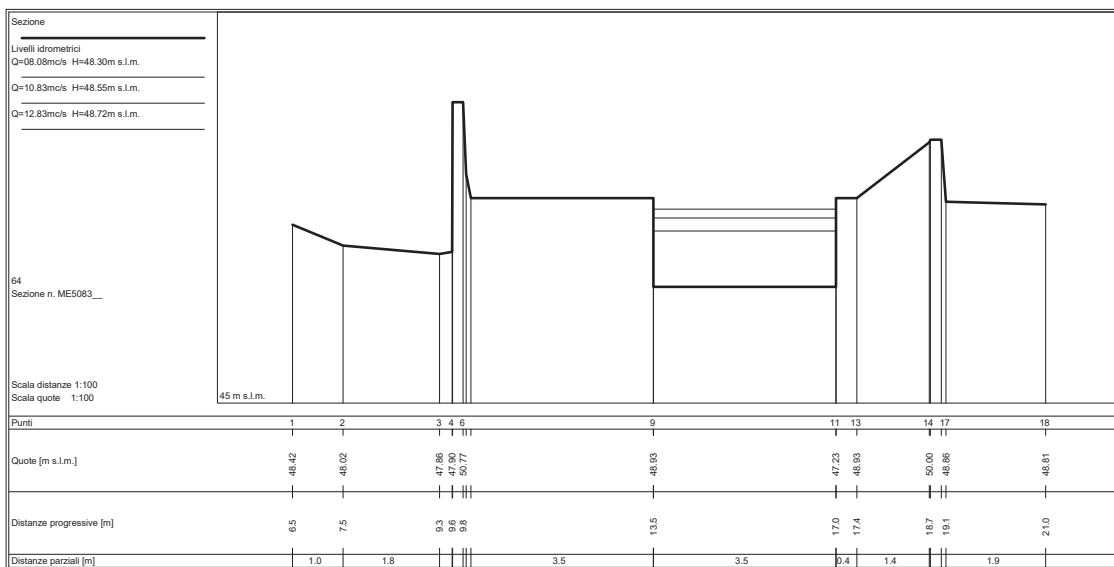
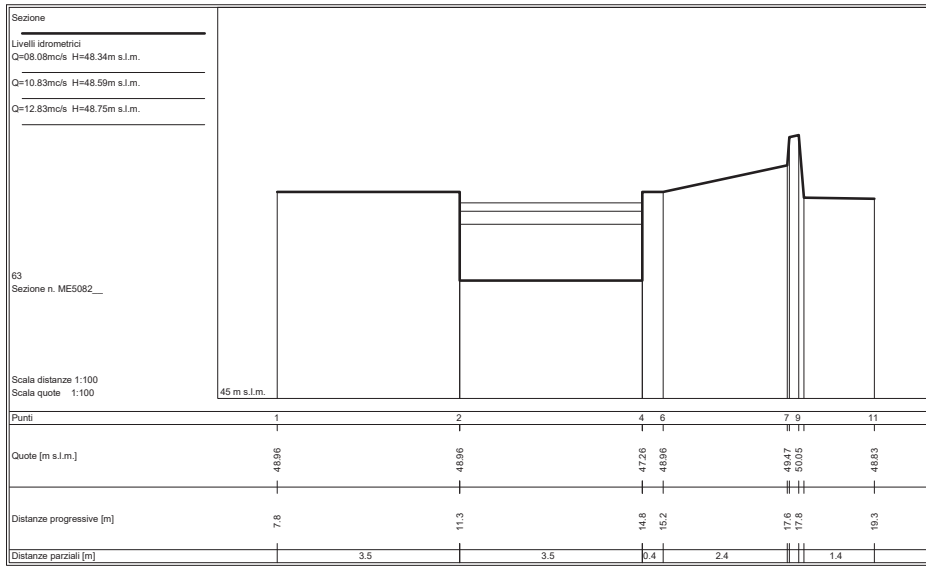

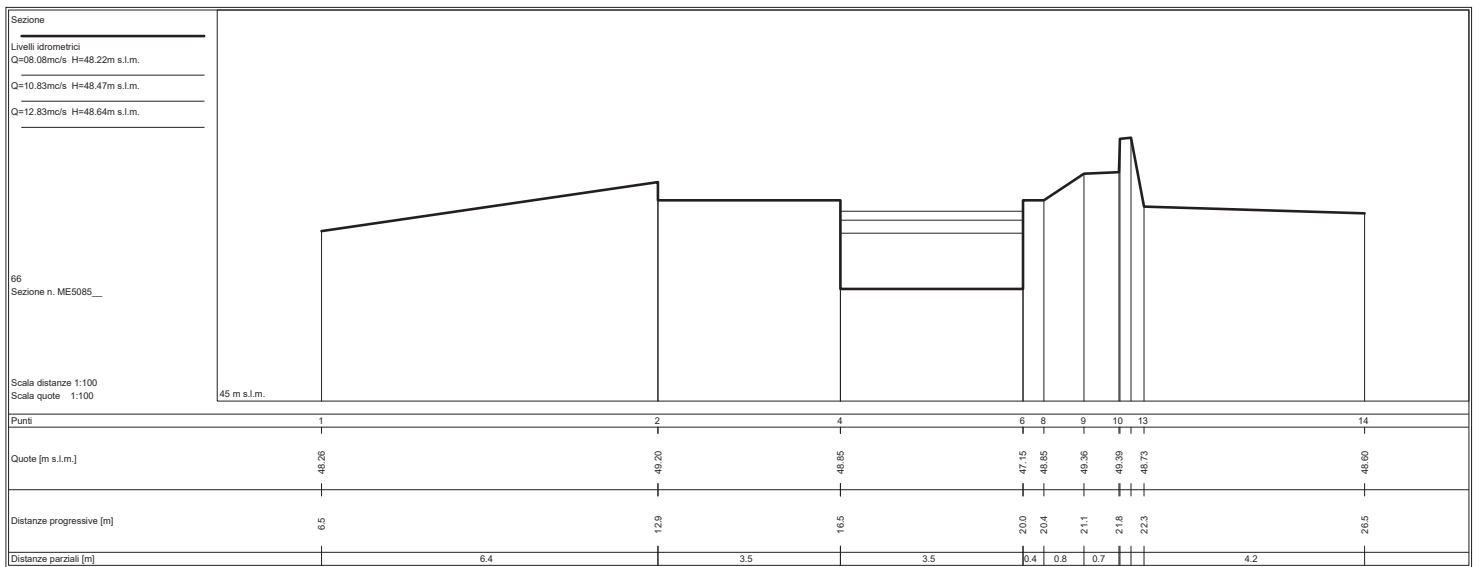
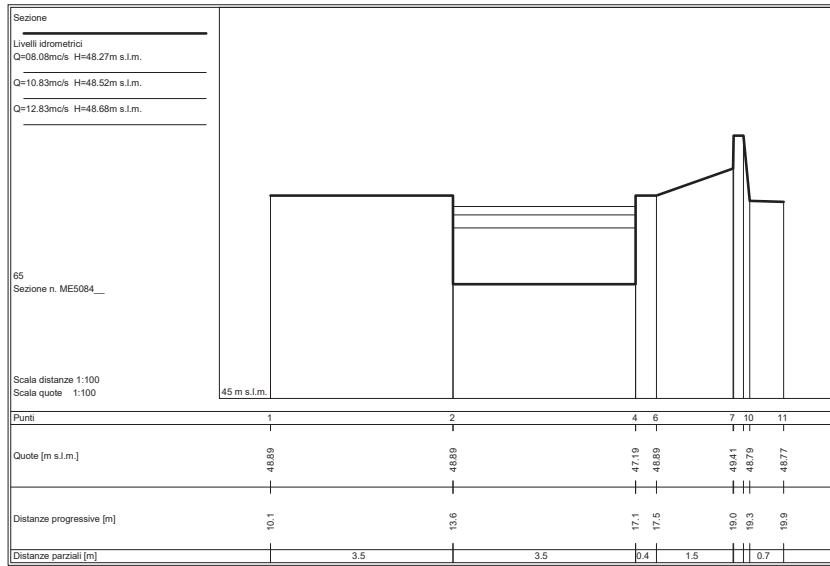

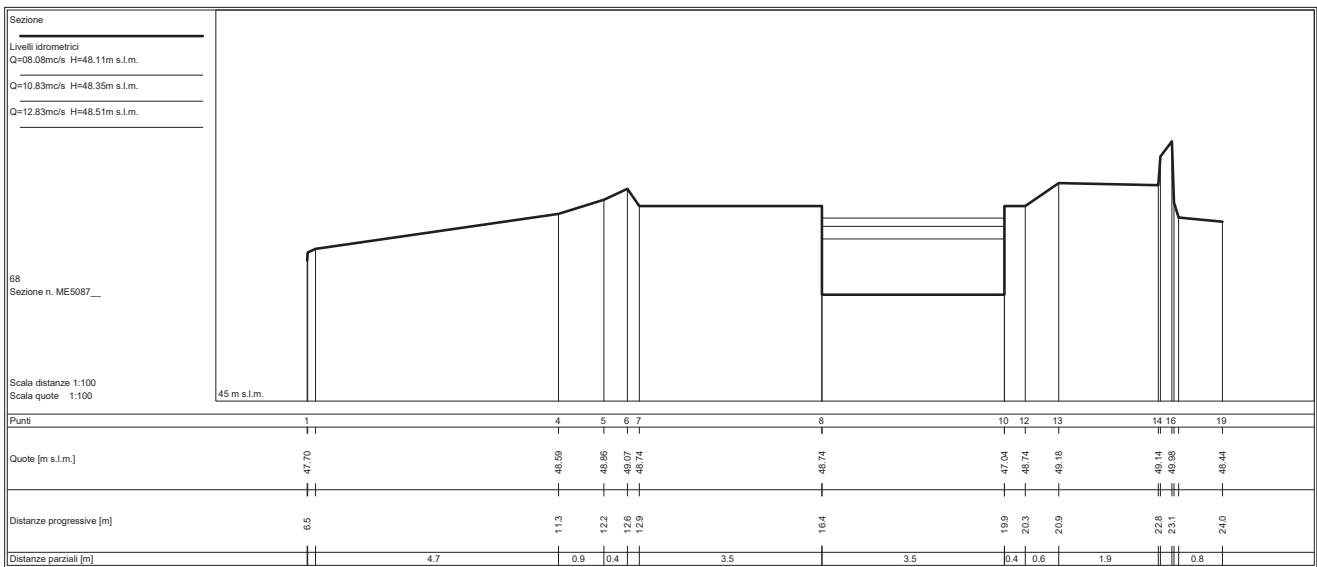
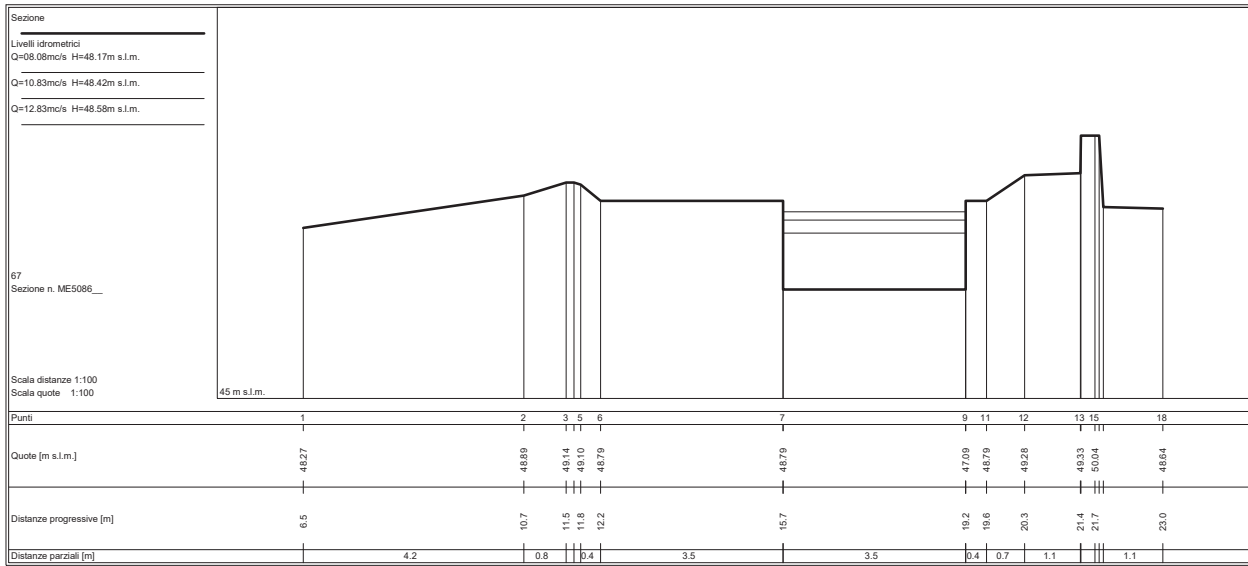

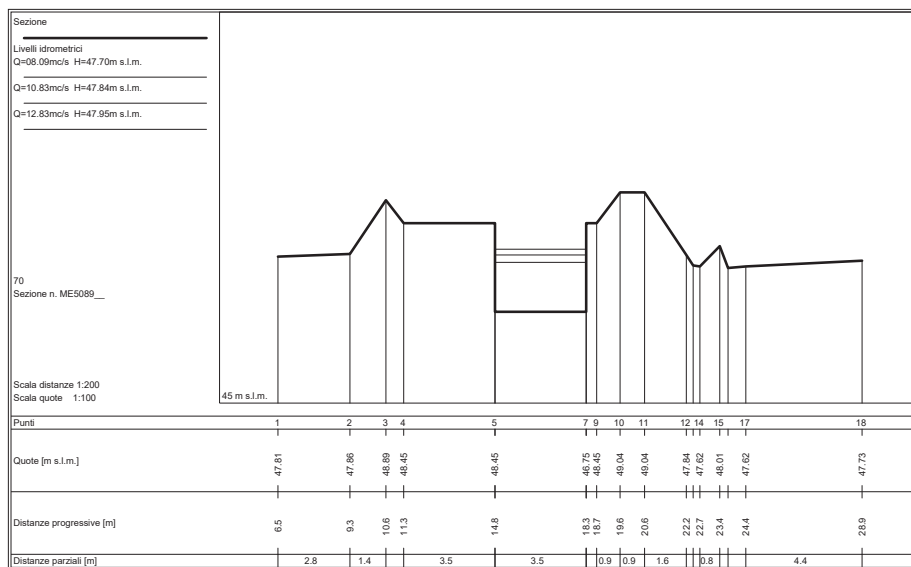
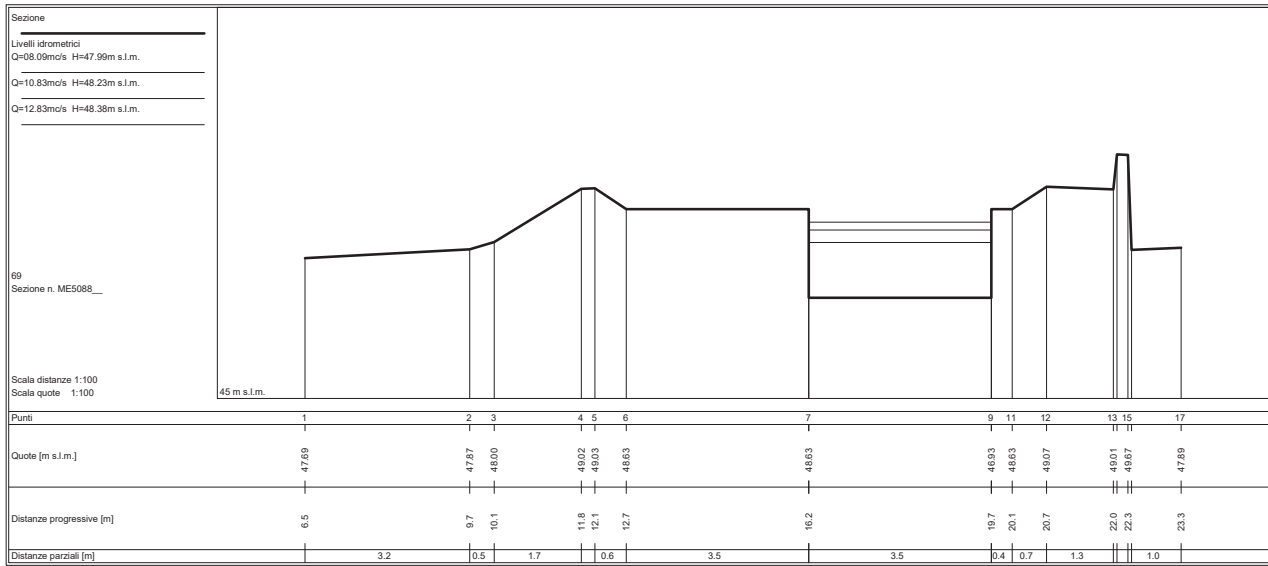

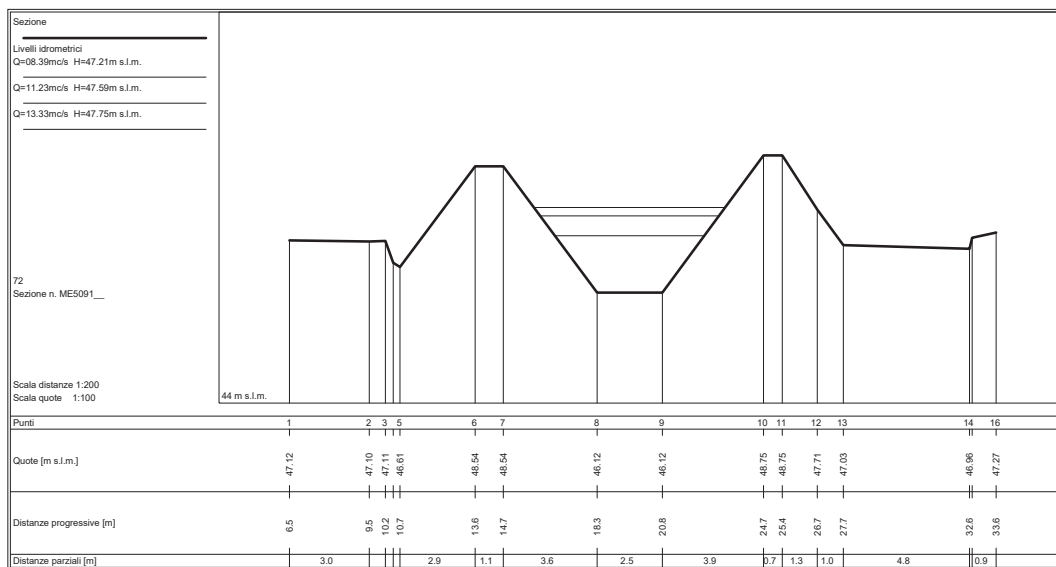
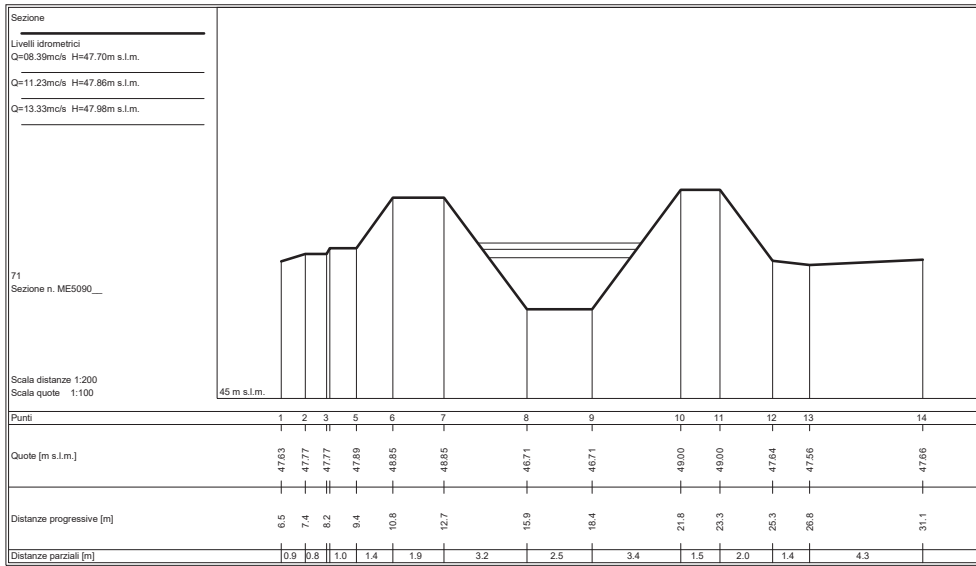

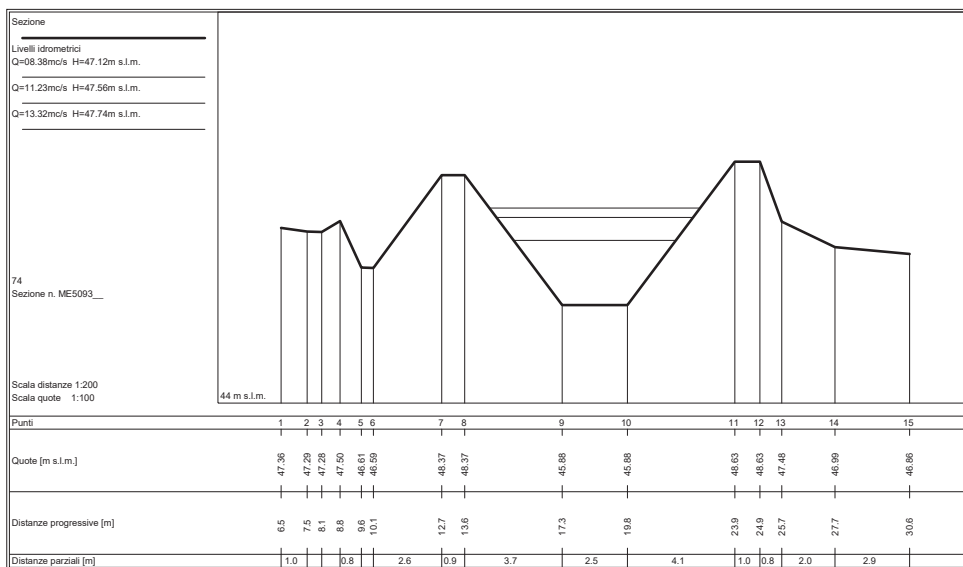
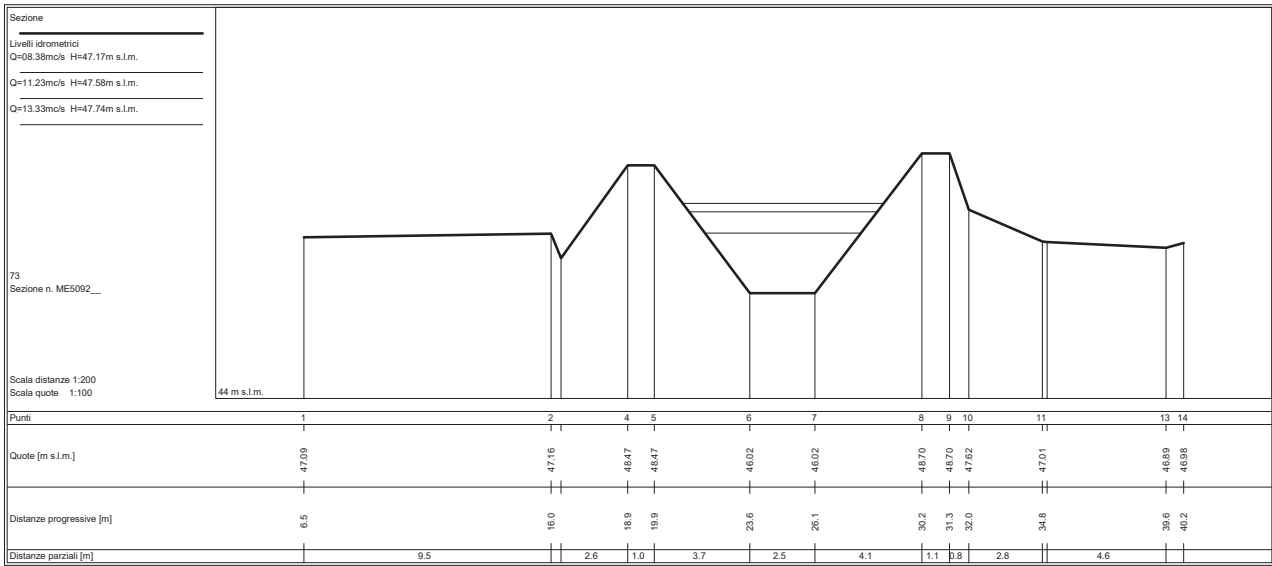

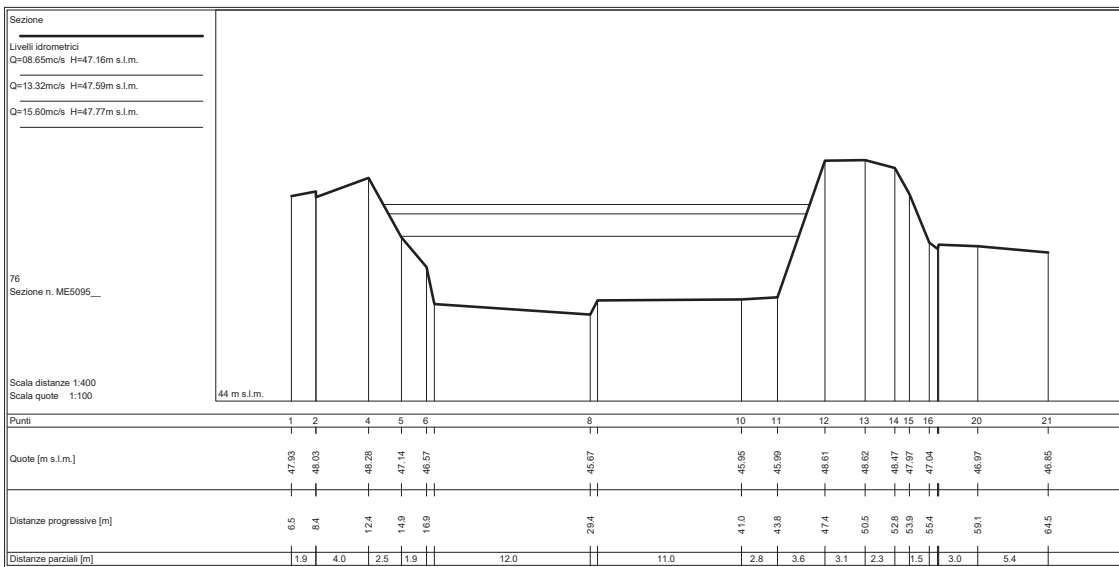
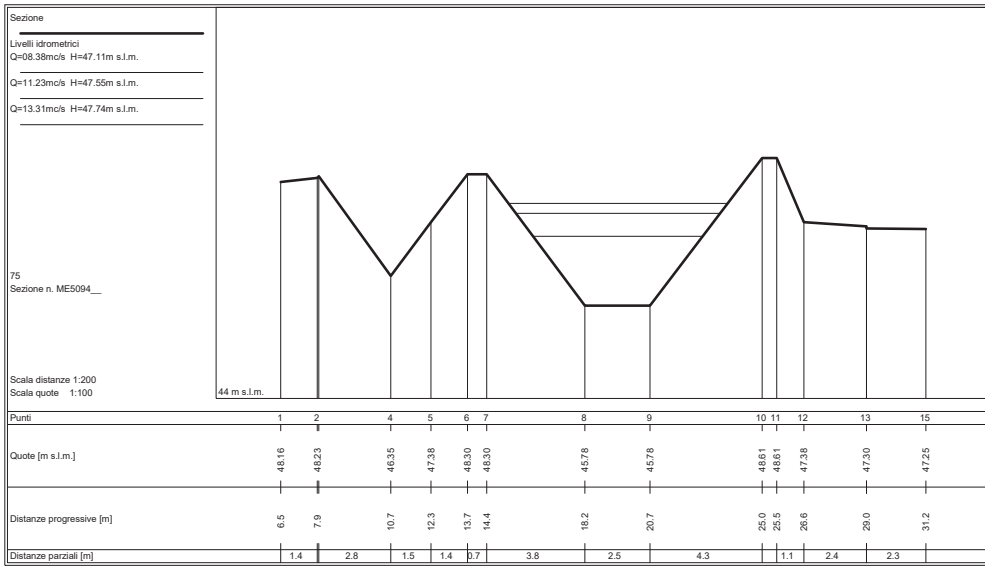



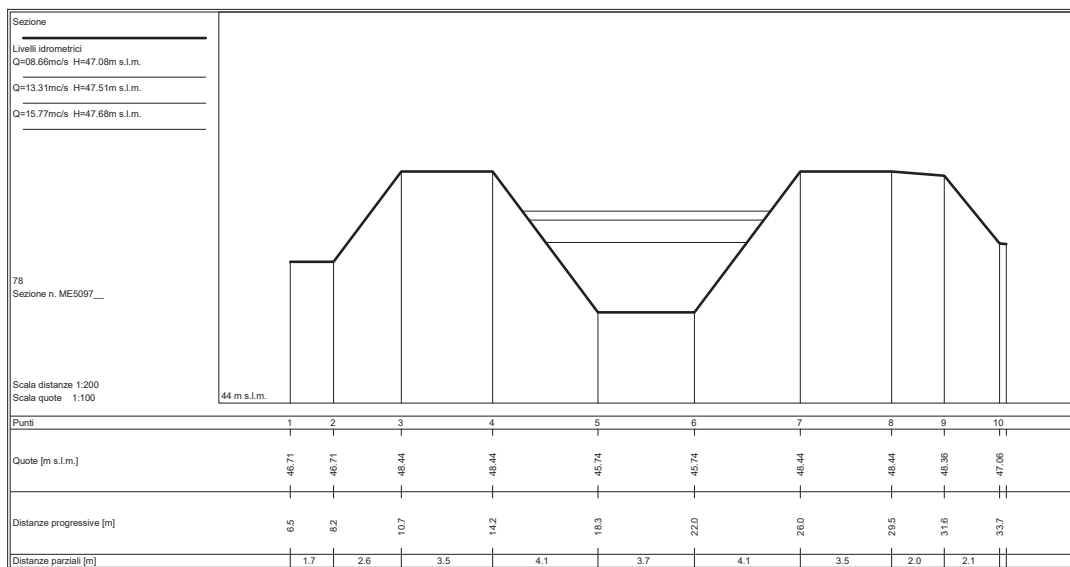
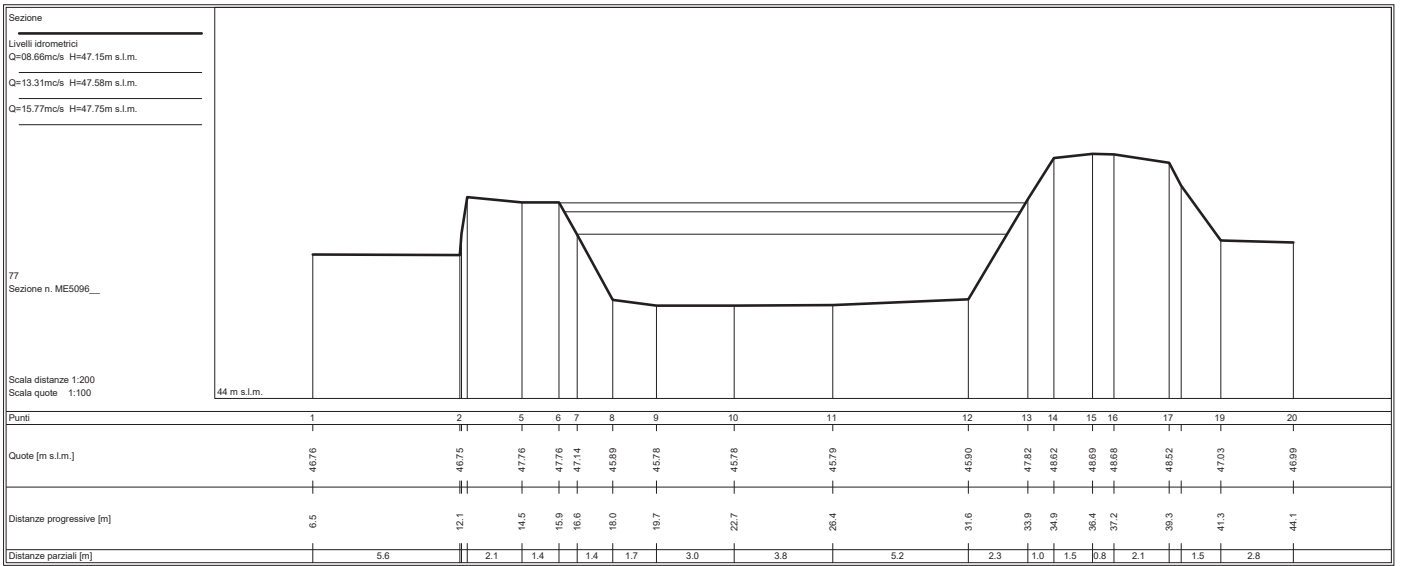

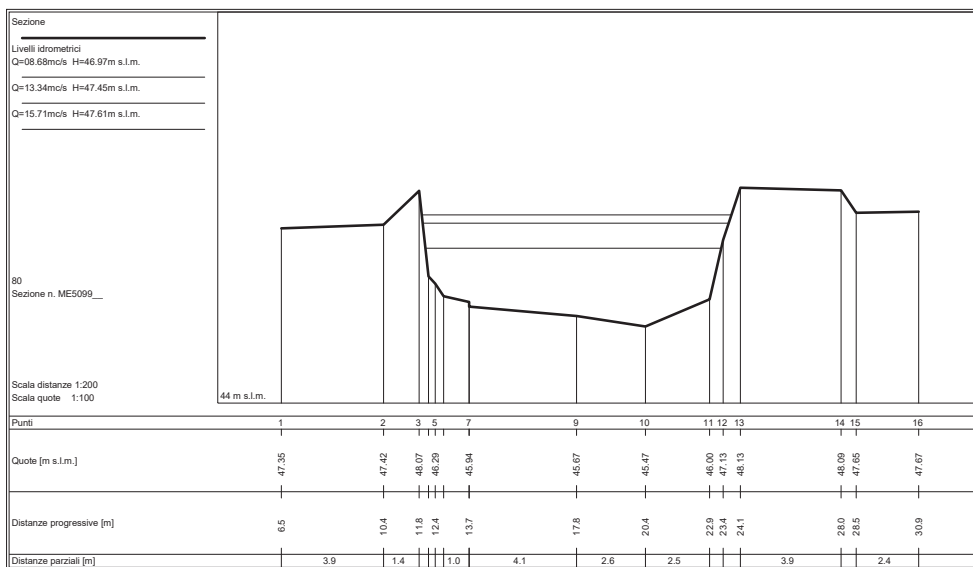
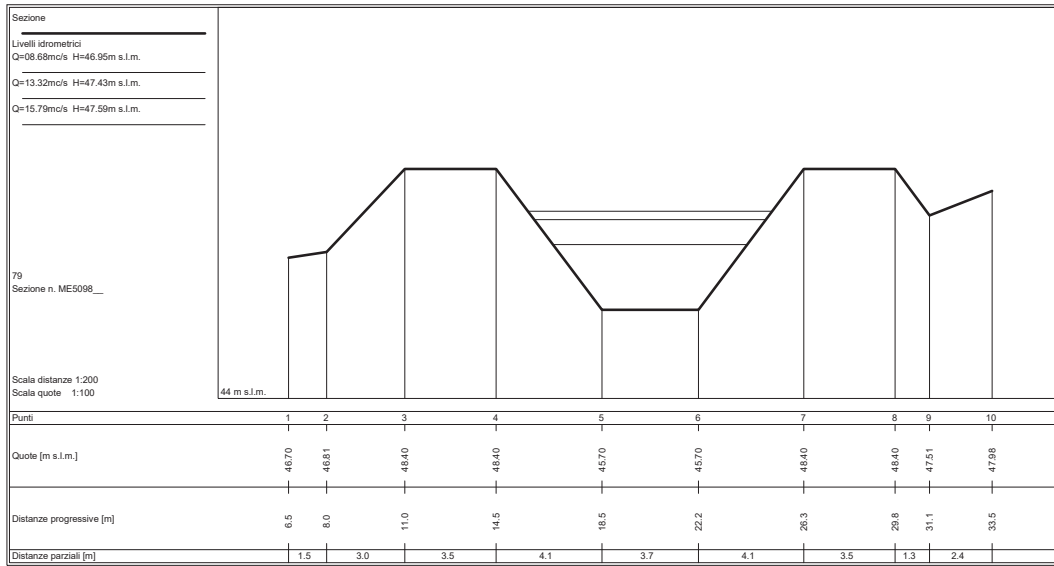

Sezione  
 Livelli idrometrici  
 Q=08.68mcls H=46.94m s.l.m.  
 Q=13.35mcls H=47.41m s.l.m.  
 Q=15.69mcls H=47.56m s.l.m.

803A  
 Sezione n. MES100A\_

Scala distanze 1:400  
 Scala quote 1:100

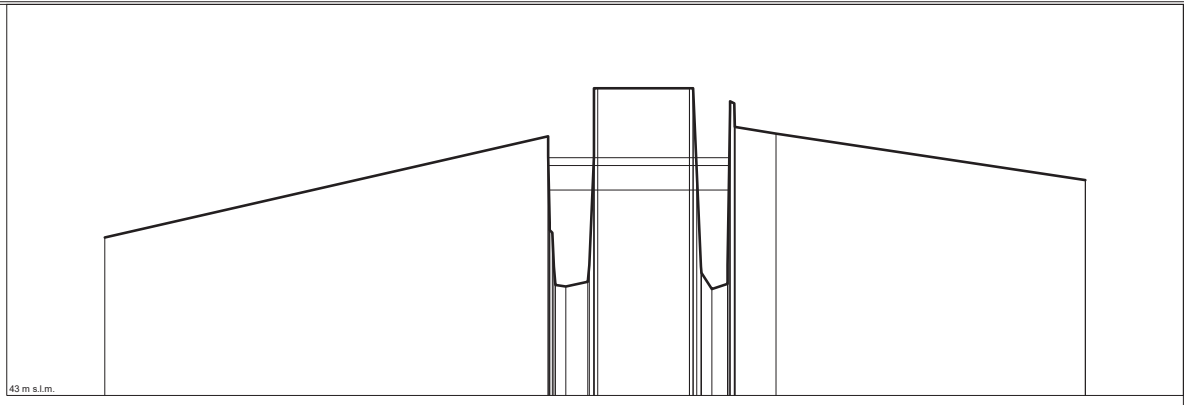

Punti	1	2	9	10	16	23	24	33	34
Quote [m s.l.m.]	46.03	47.97	45.09	45.18	48.89	45.04	45.14	48.02	47.13
Distanze progressive [m]	6.0	40.0	41.4	43.0	50.8	52.6	53.8	57.5	81.2
Distanze parziali [m]		34.0	1.7		7.0		3.2	23.7	

SEZIONI FLUVIALI  
FOSSO MENDACIONE - TRATTO 2

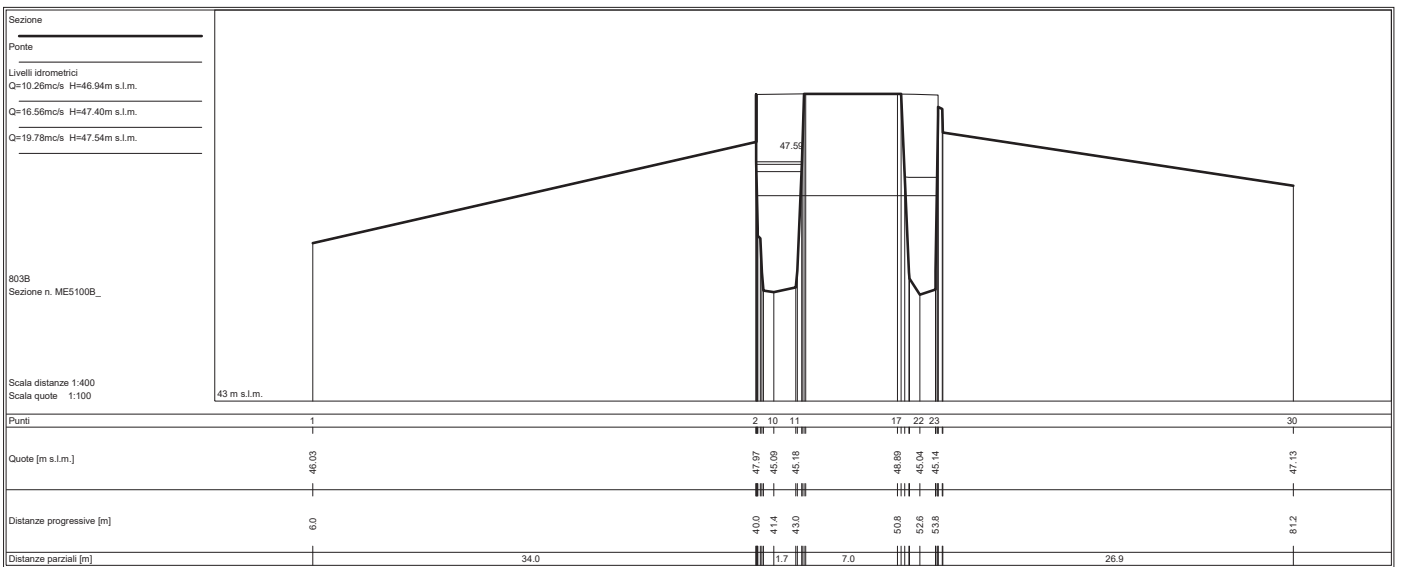
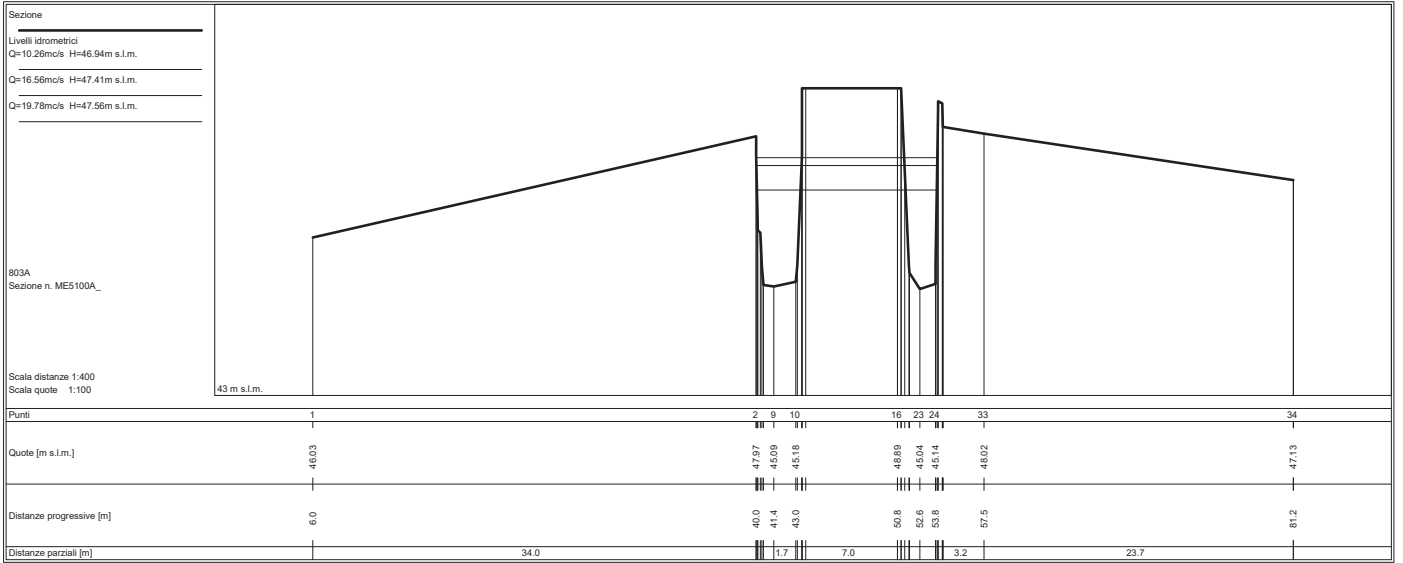

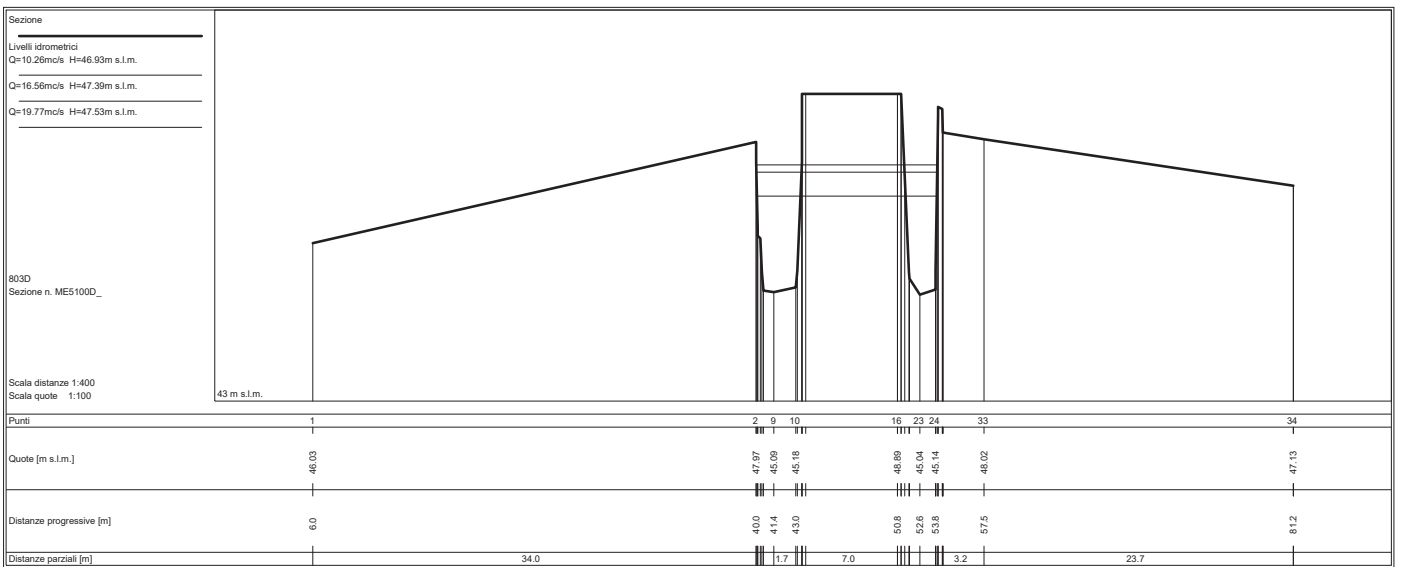
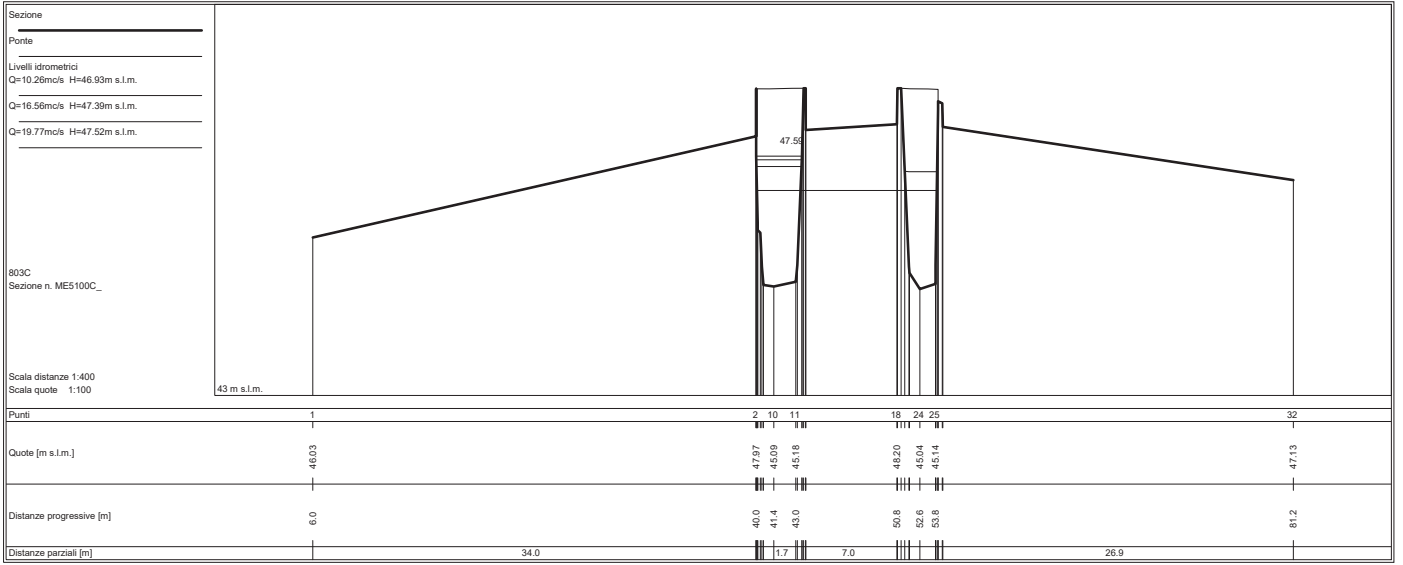

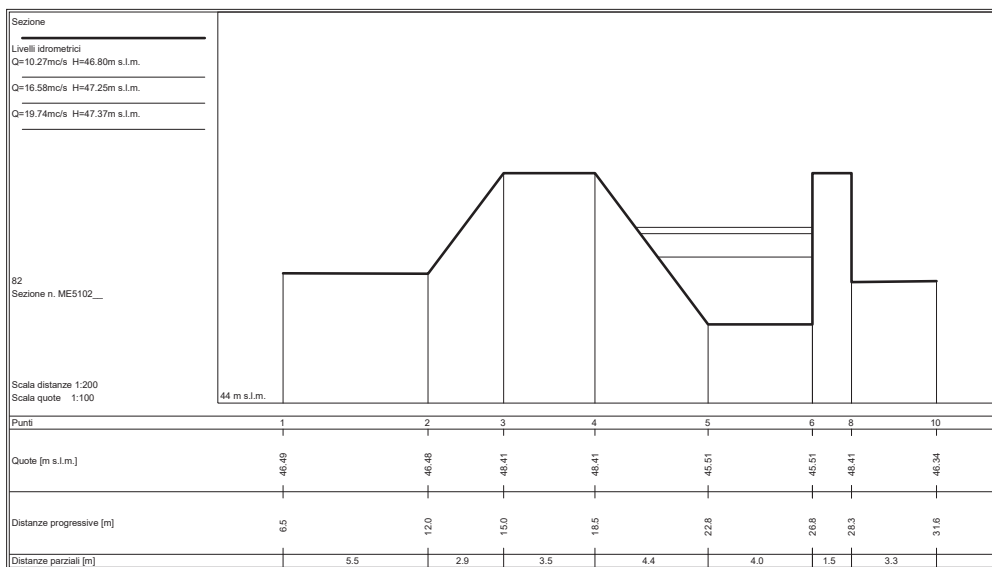
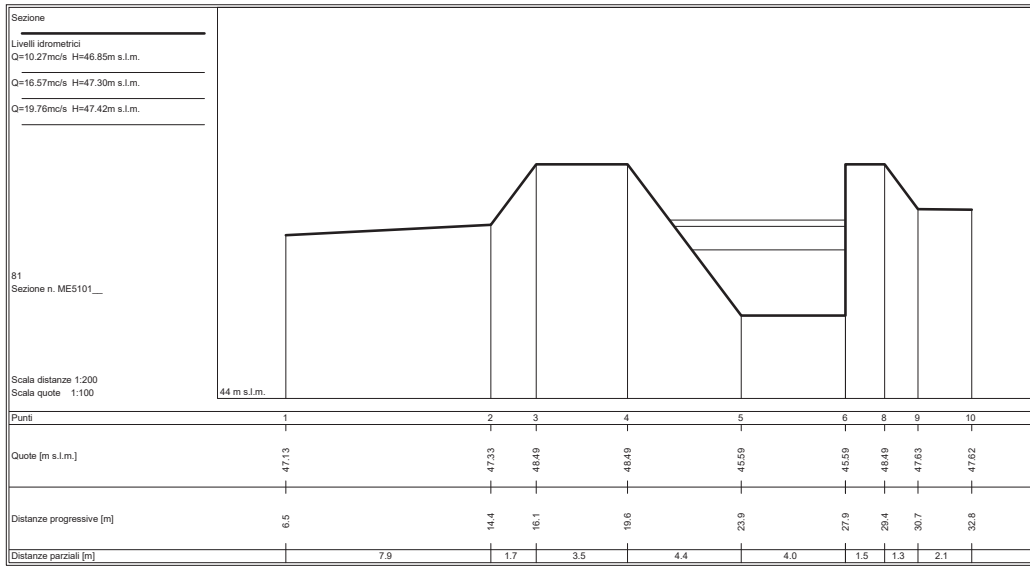

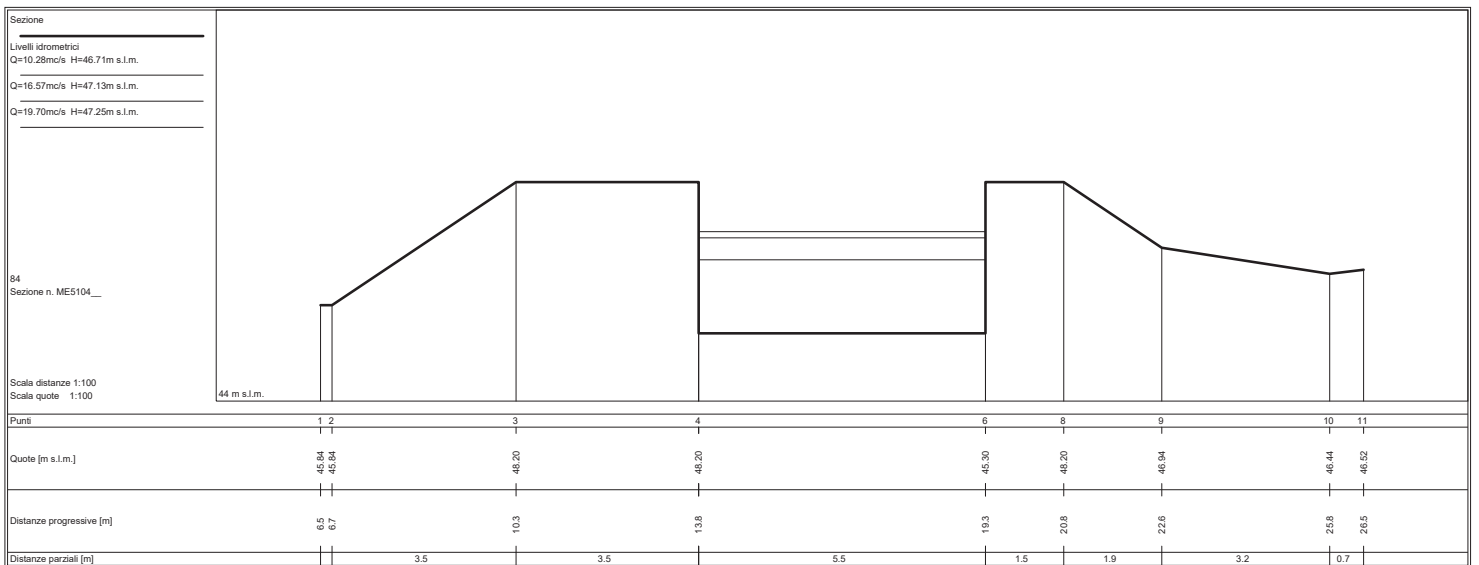
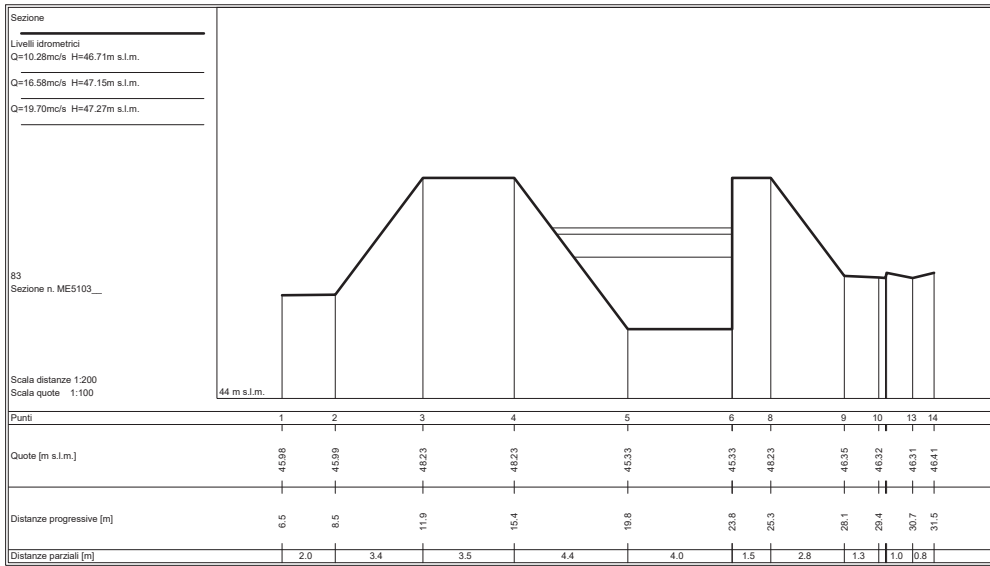



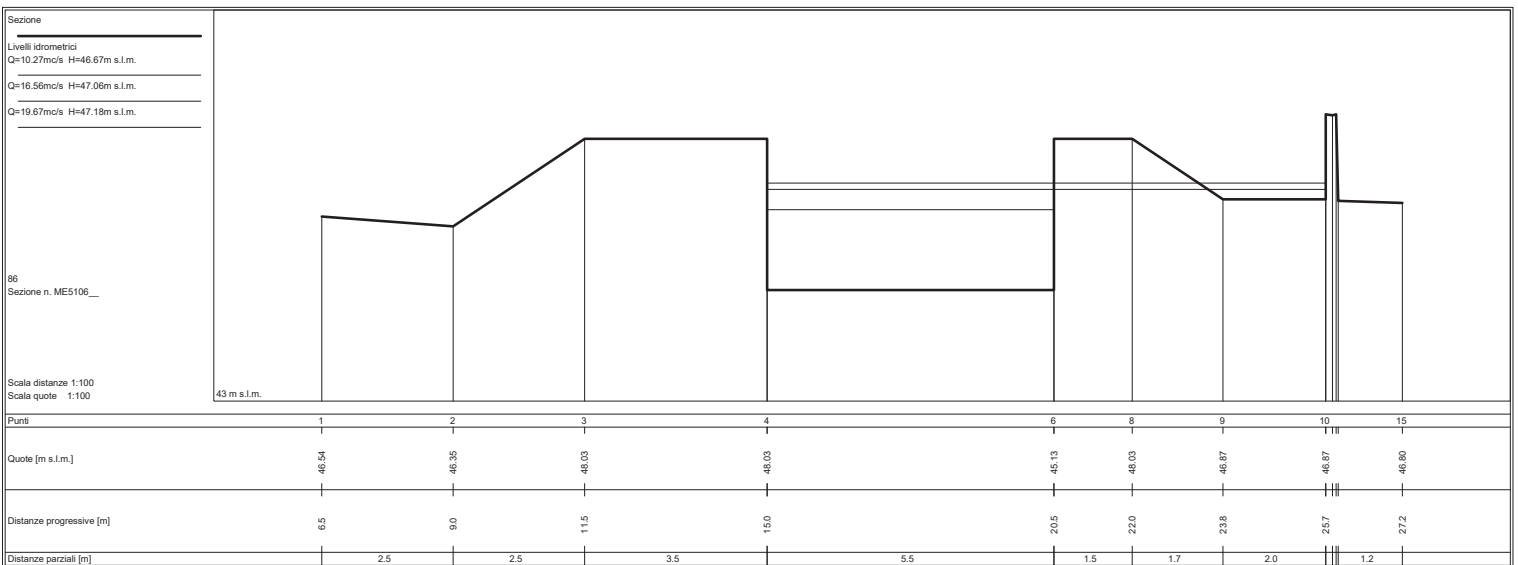
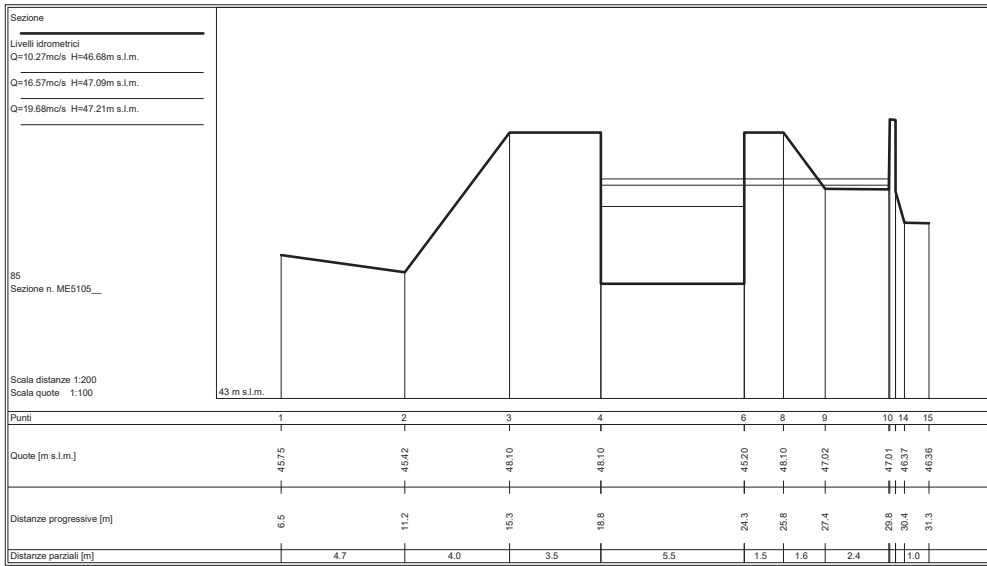

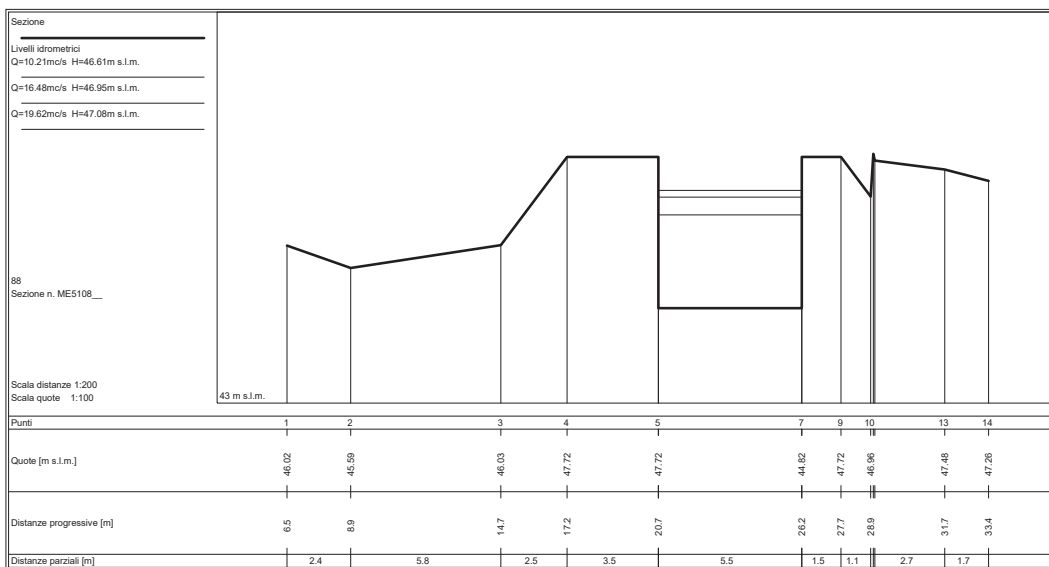
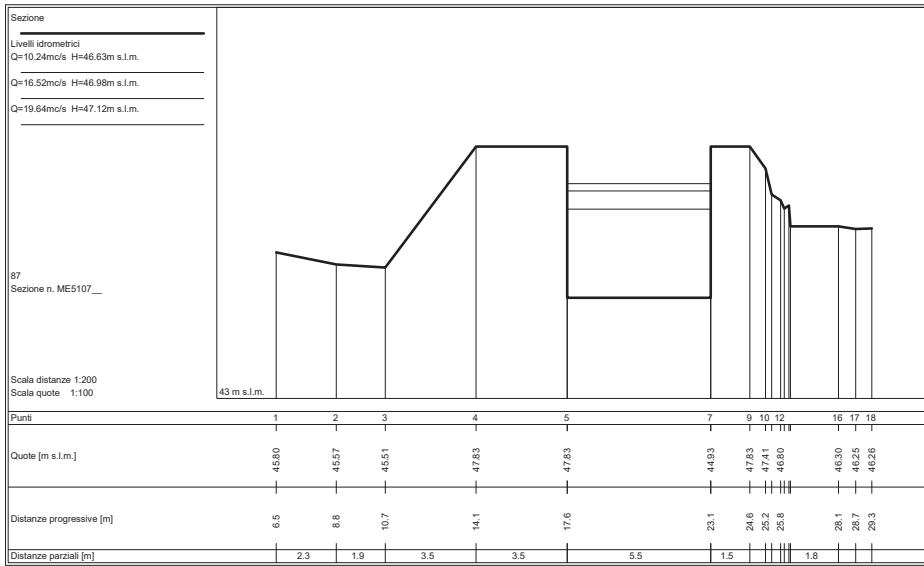

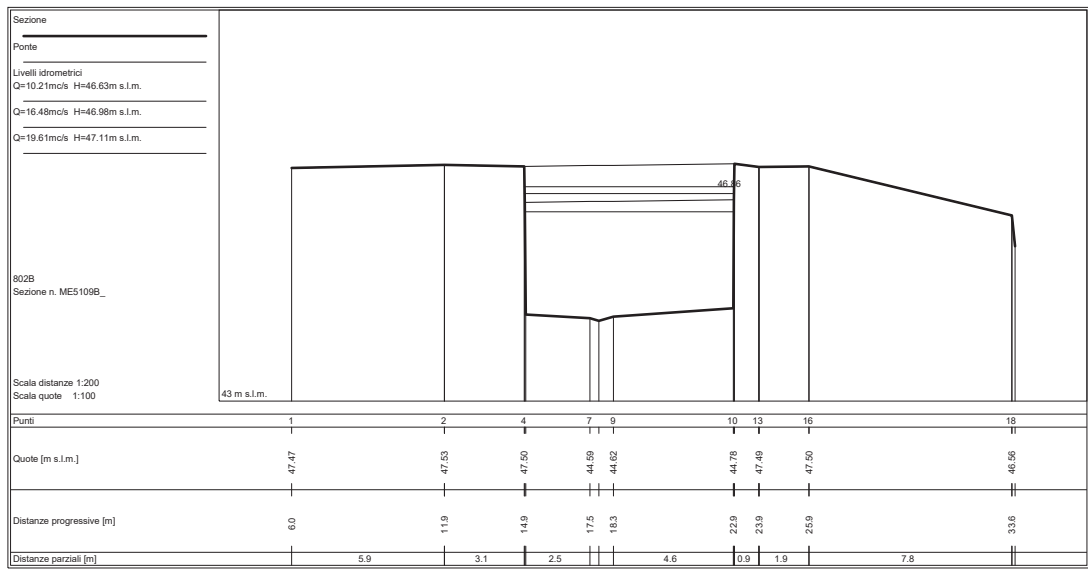
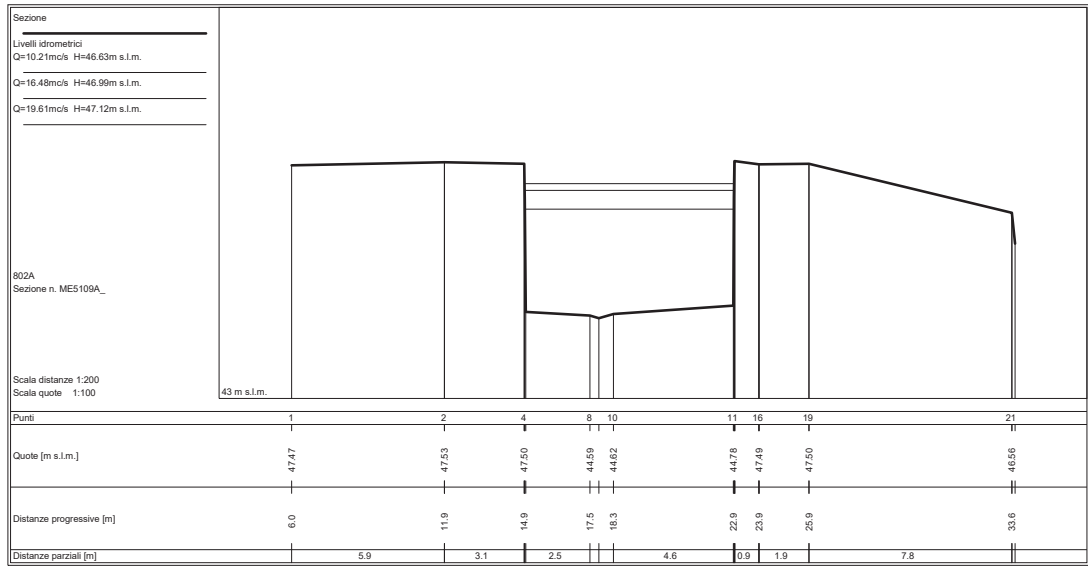

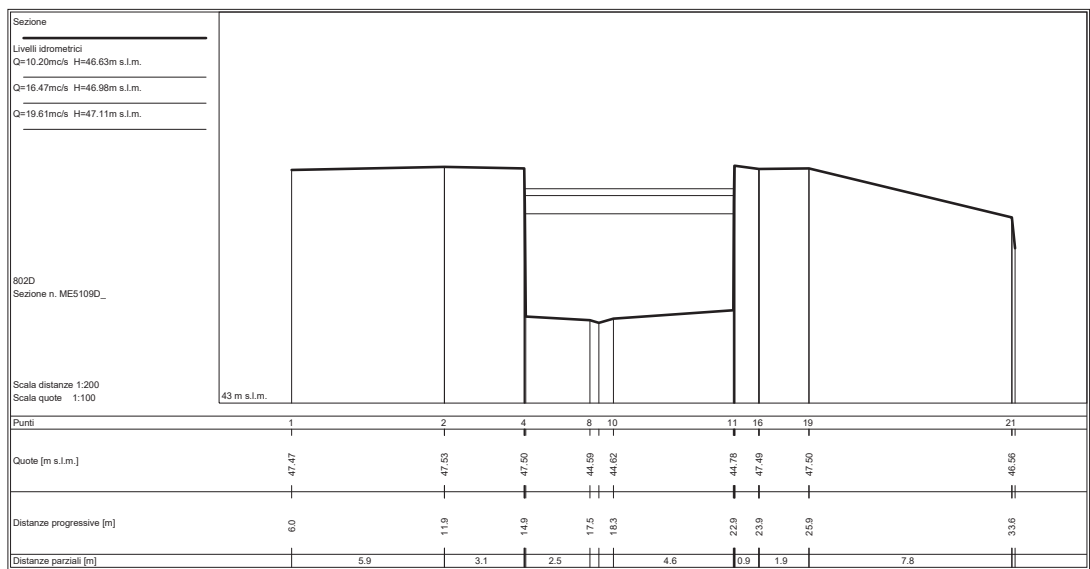
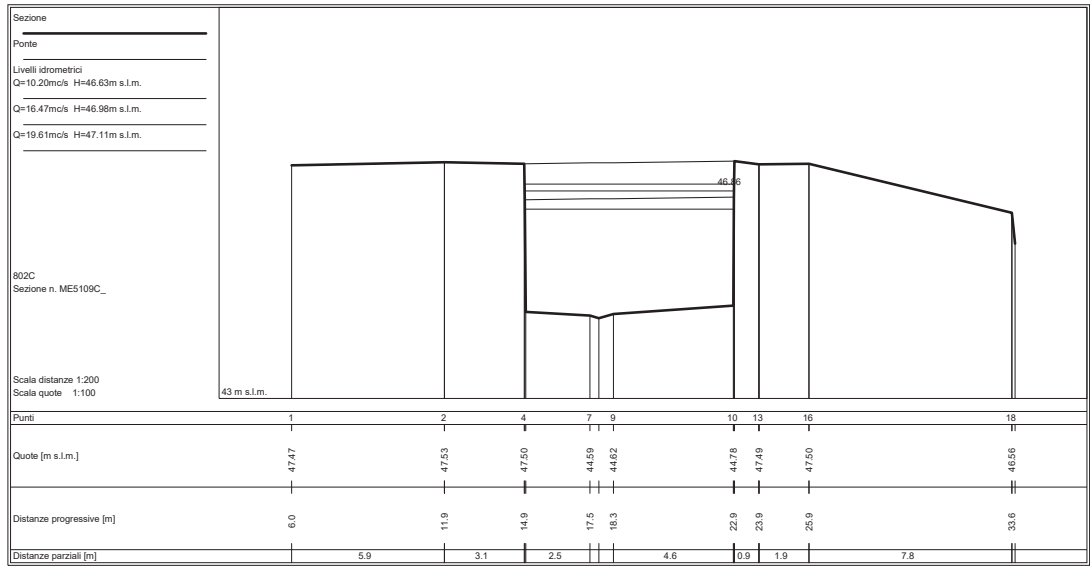

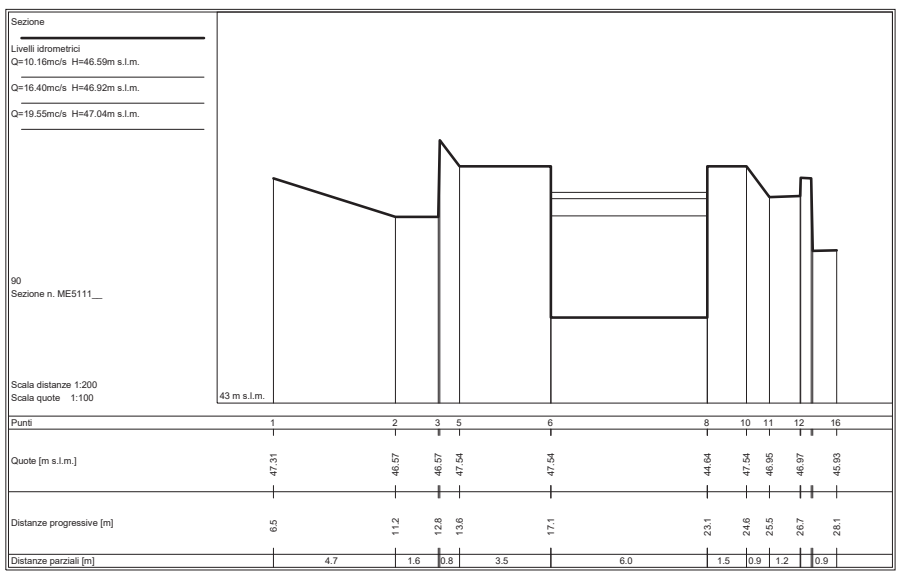
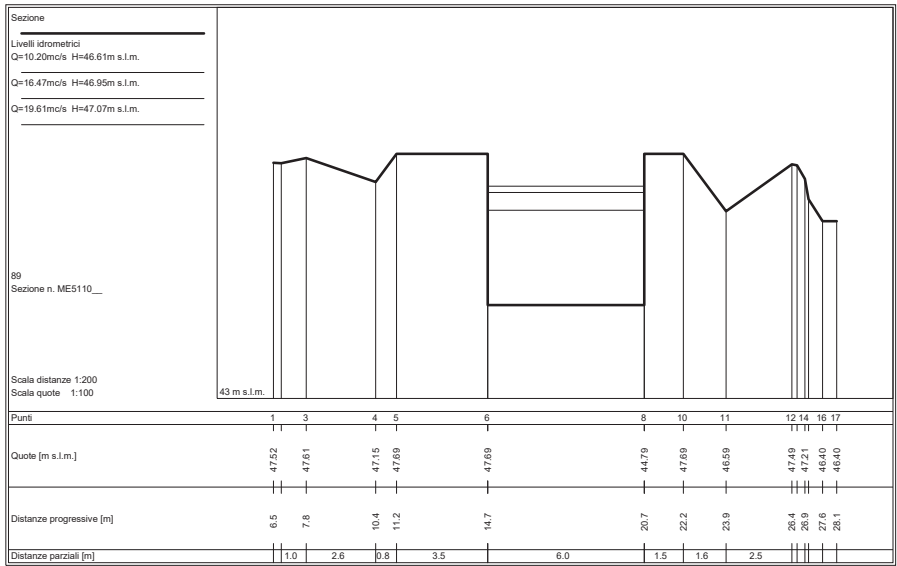

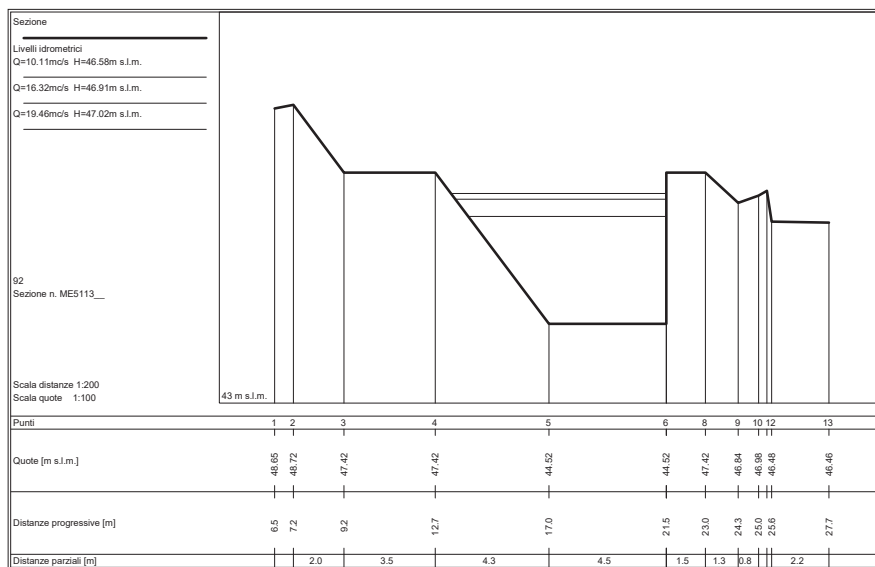
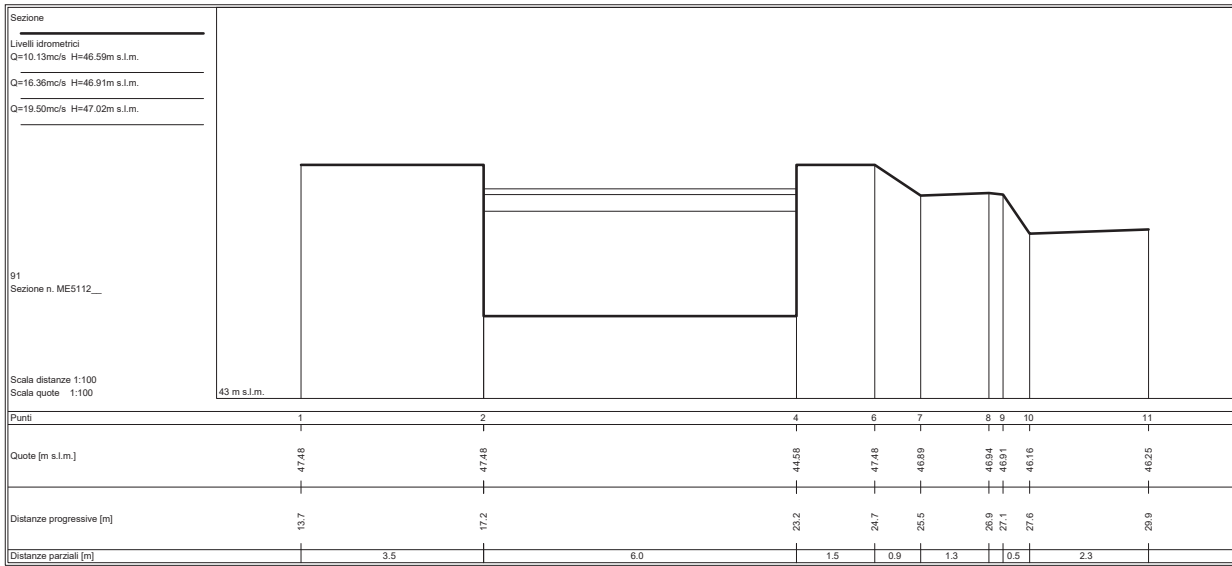

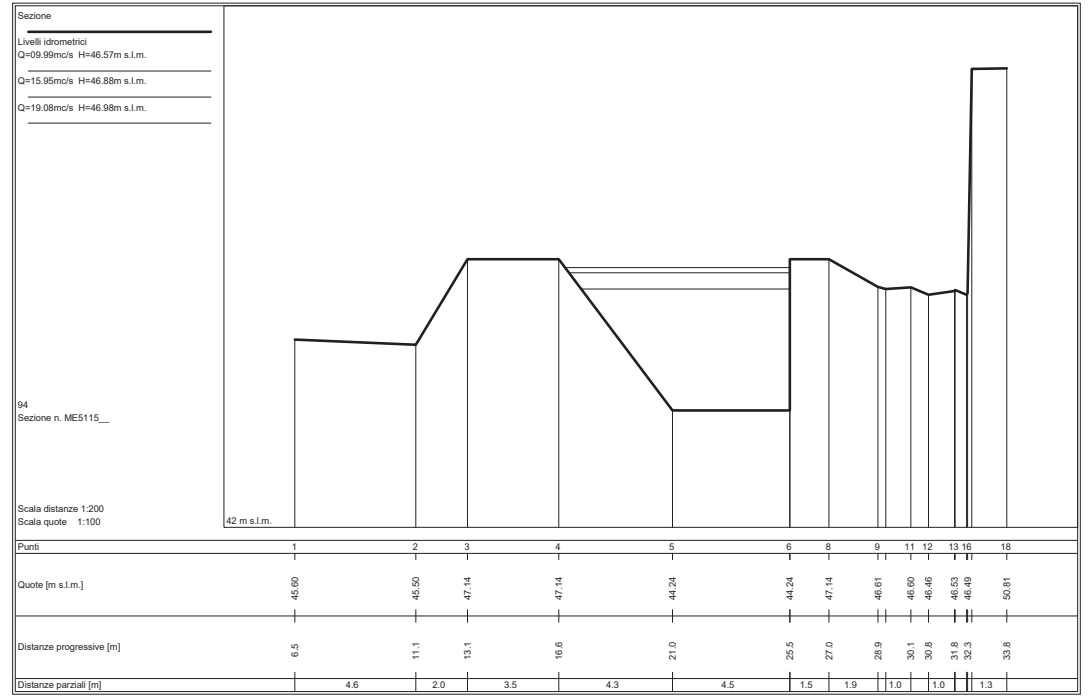
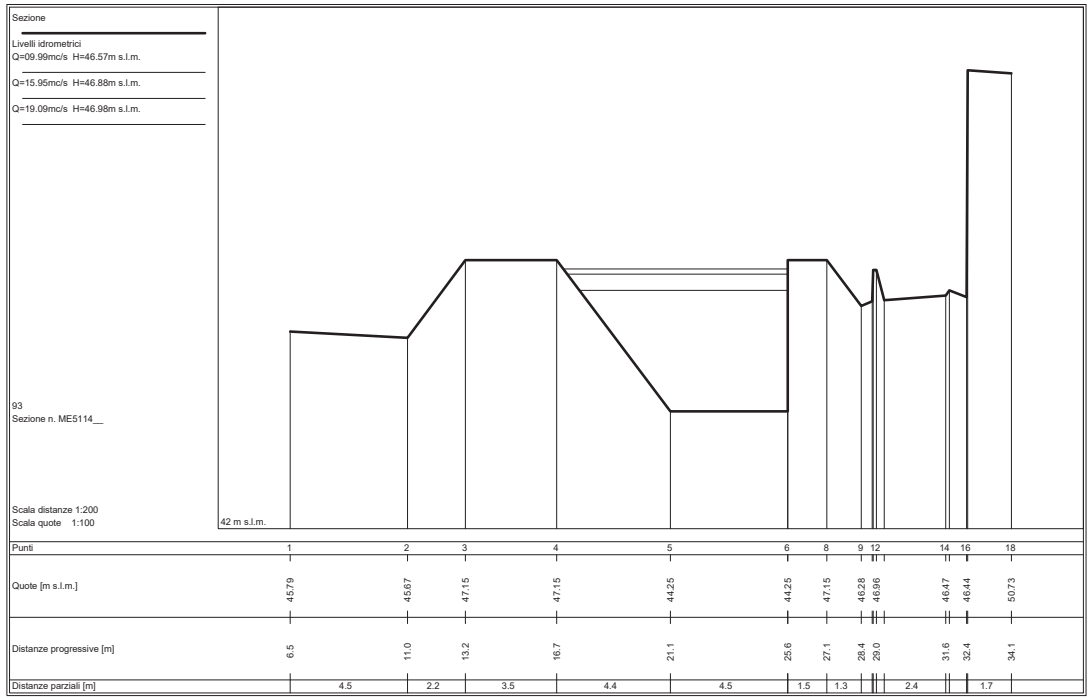

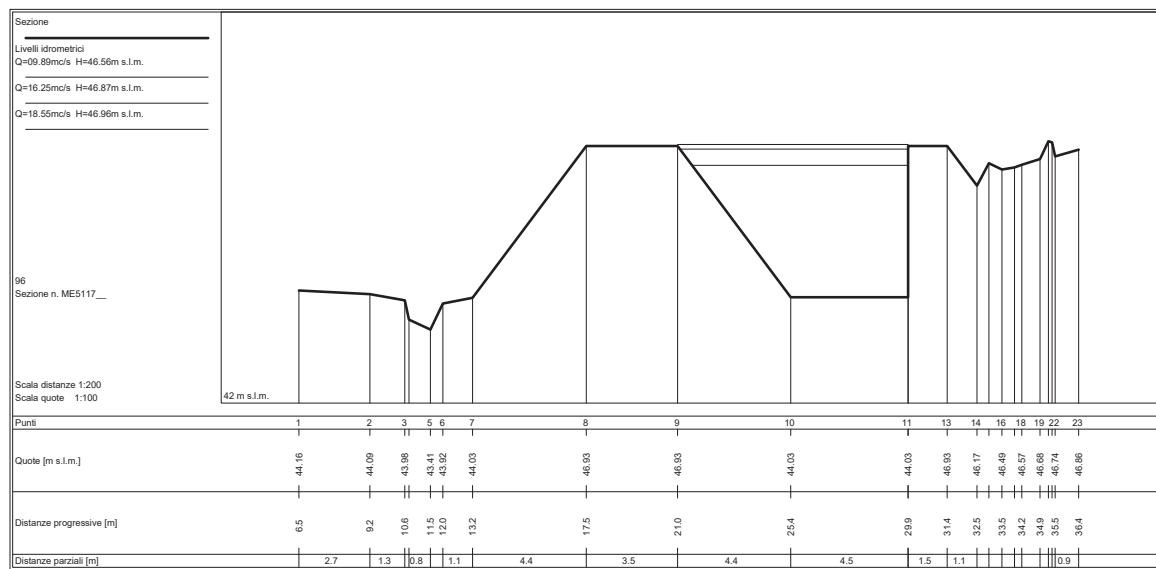
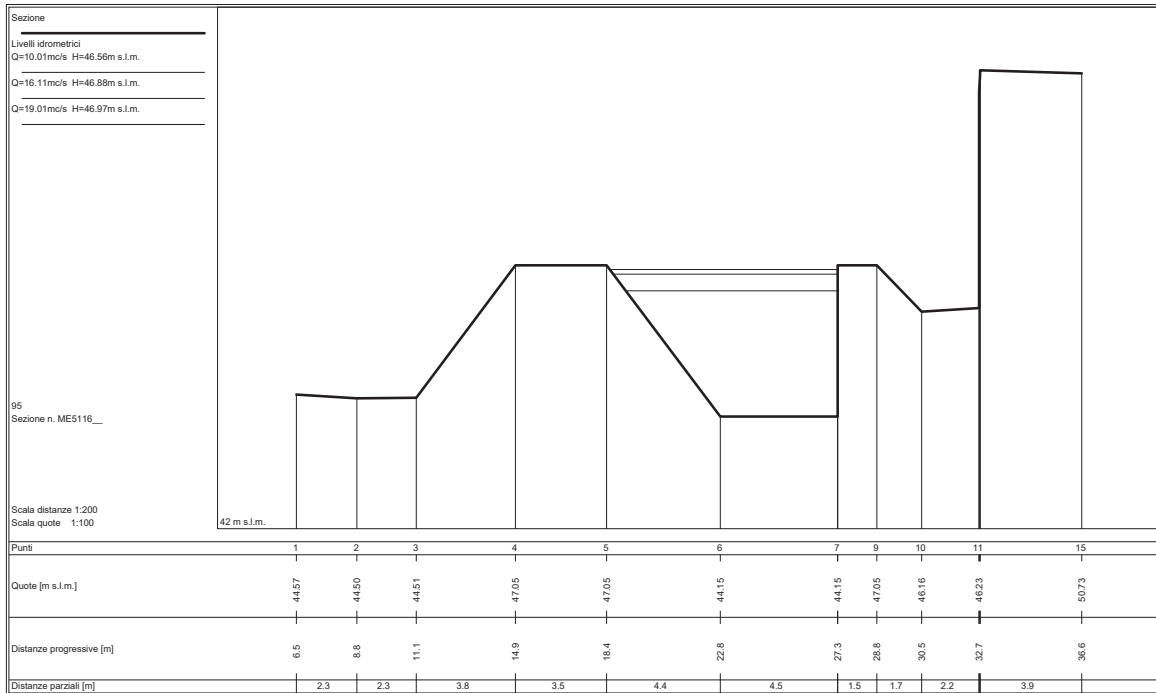



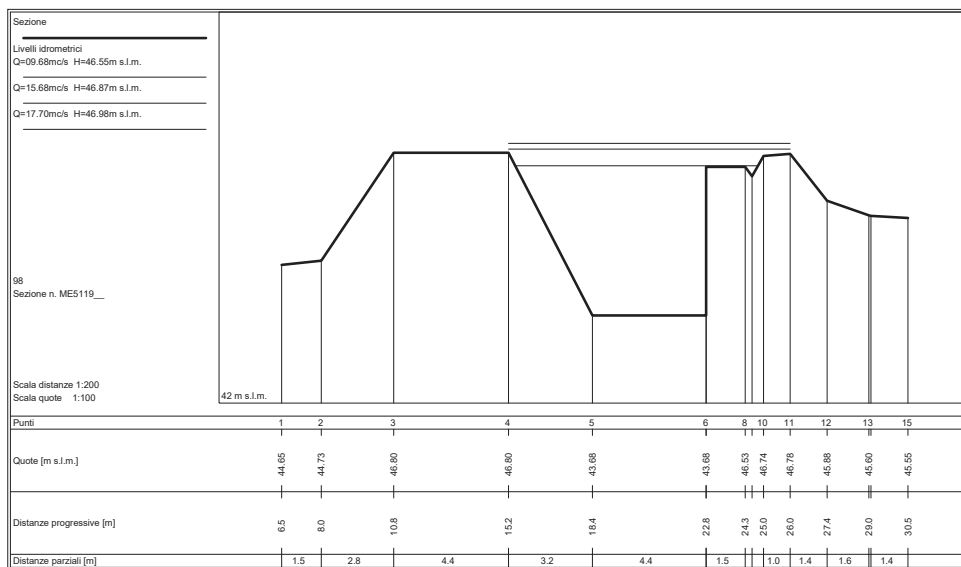
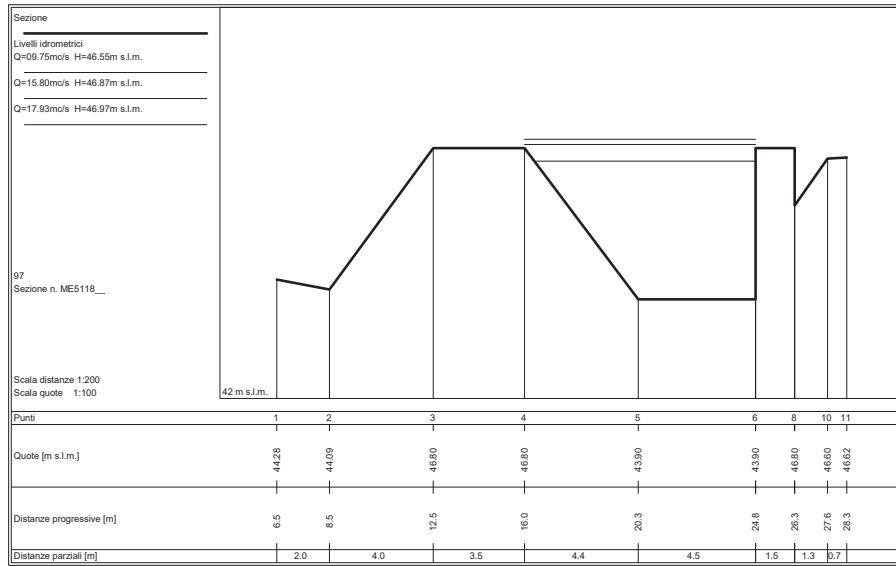

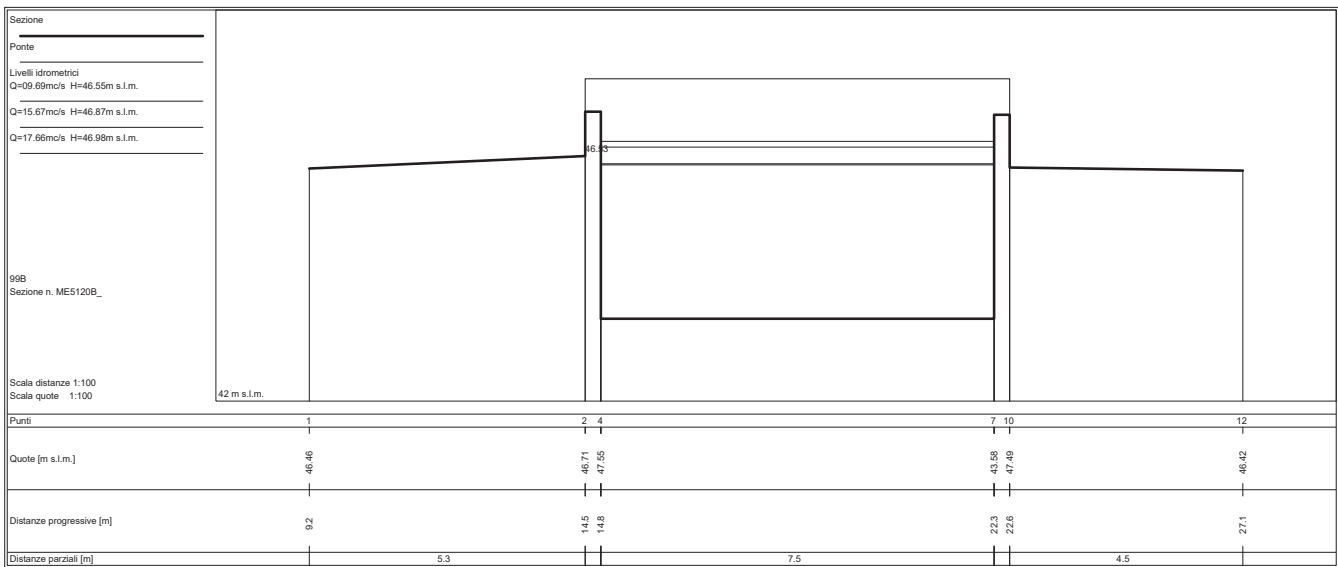
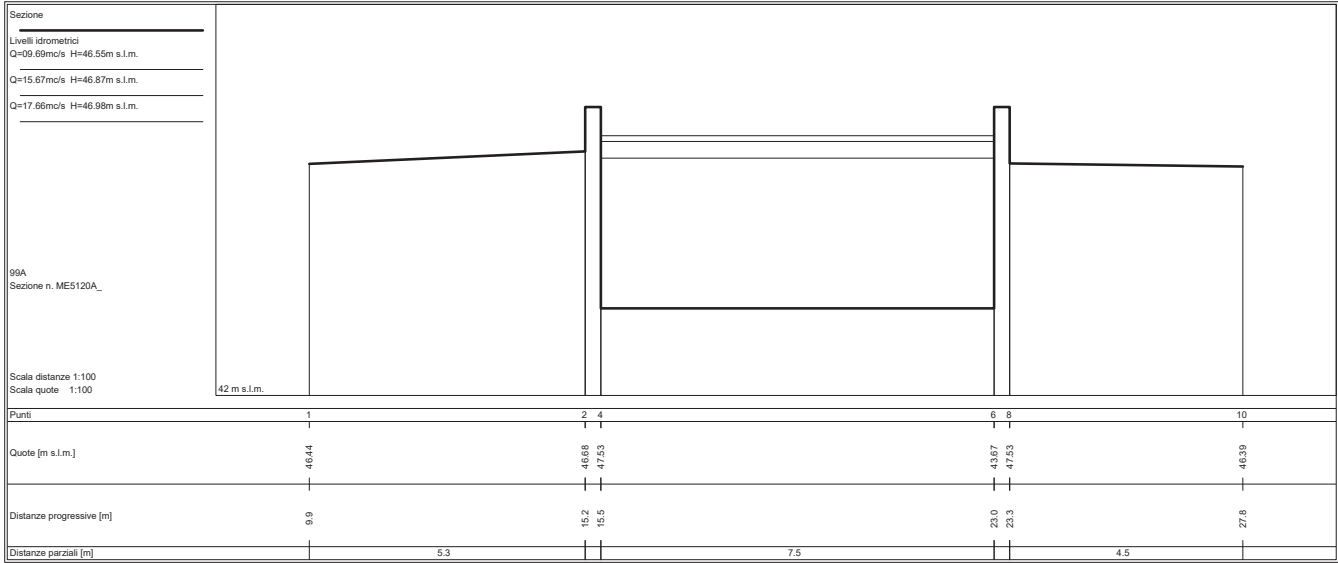

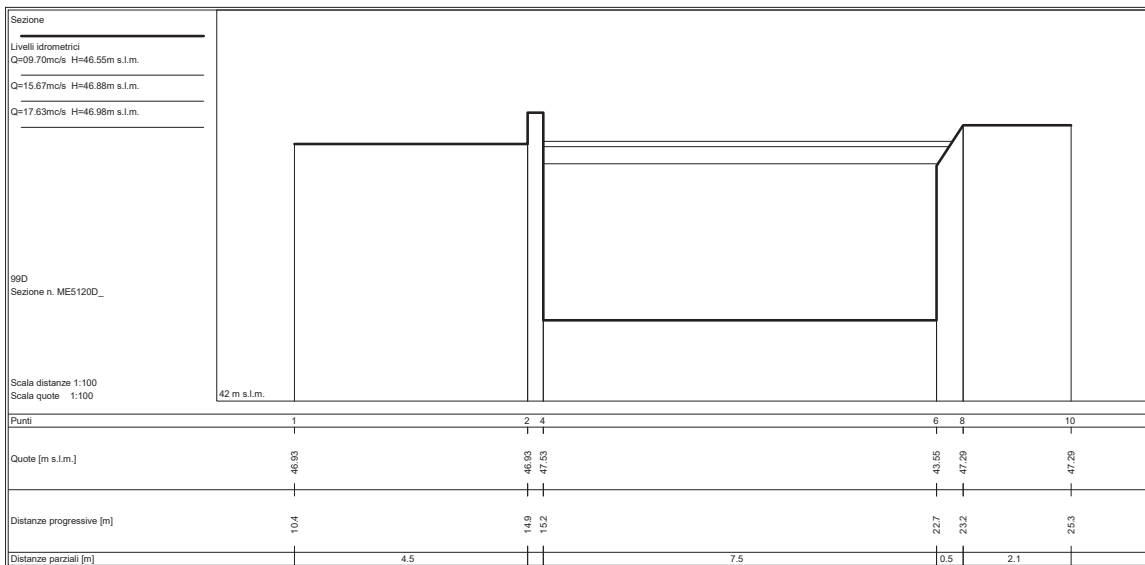
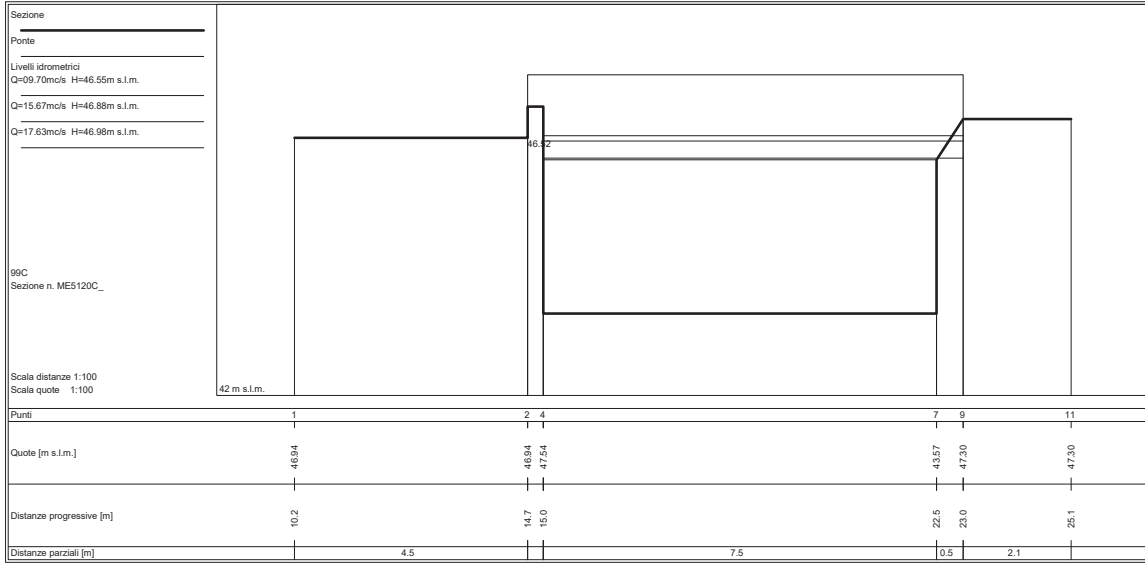

SEZIONI FLUVIALI  
FOSSO MENDACIONE - TRATTO 3

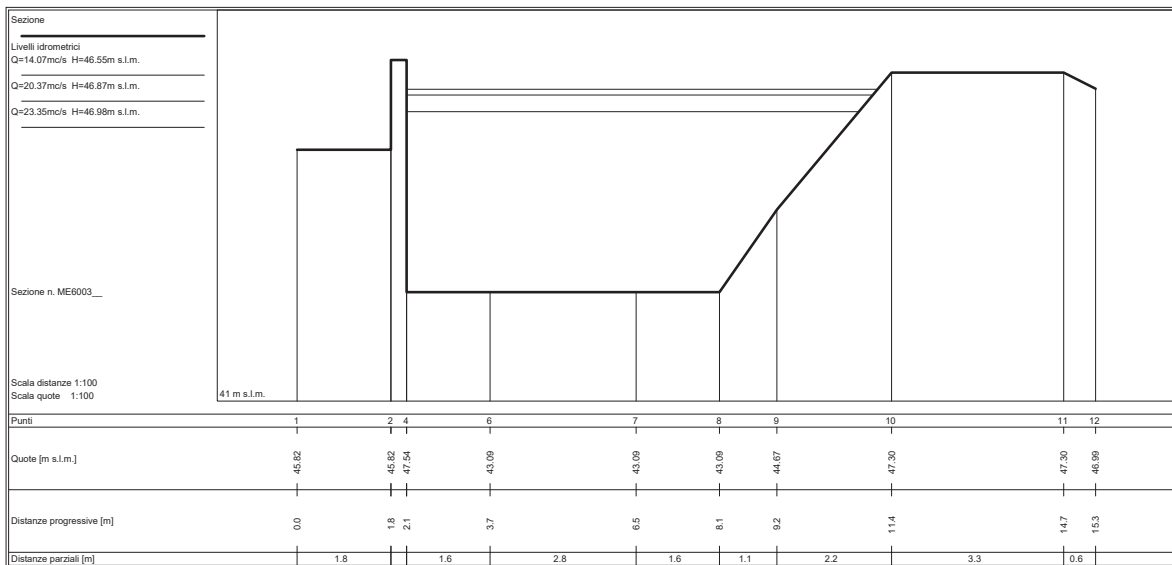
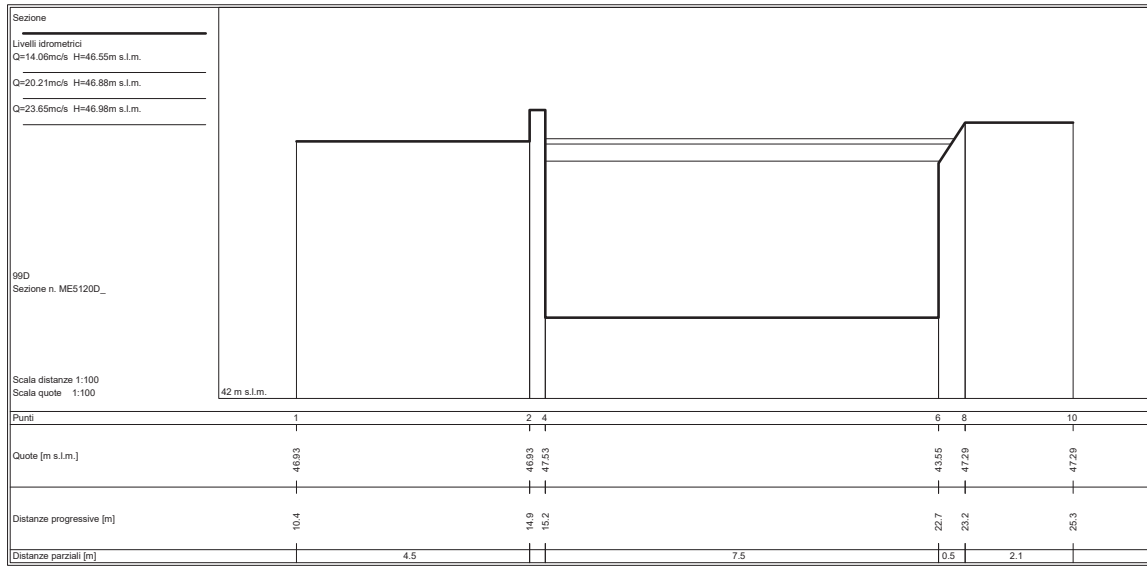

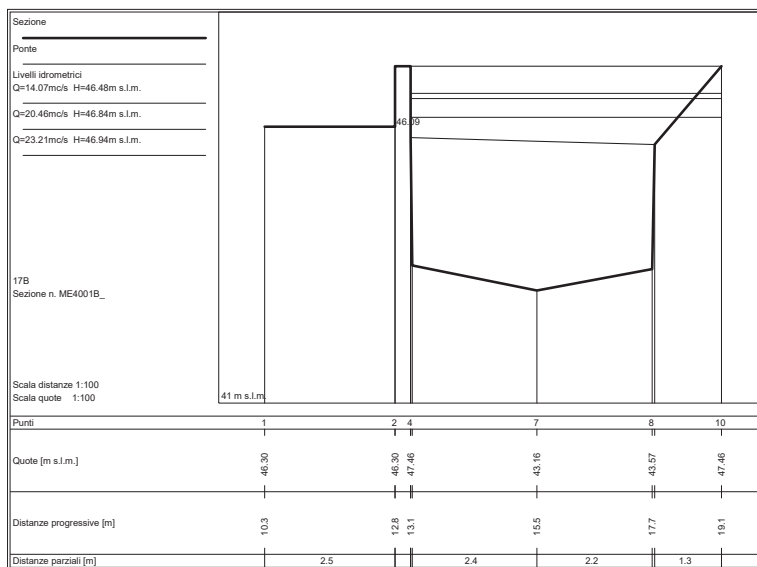
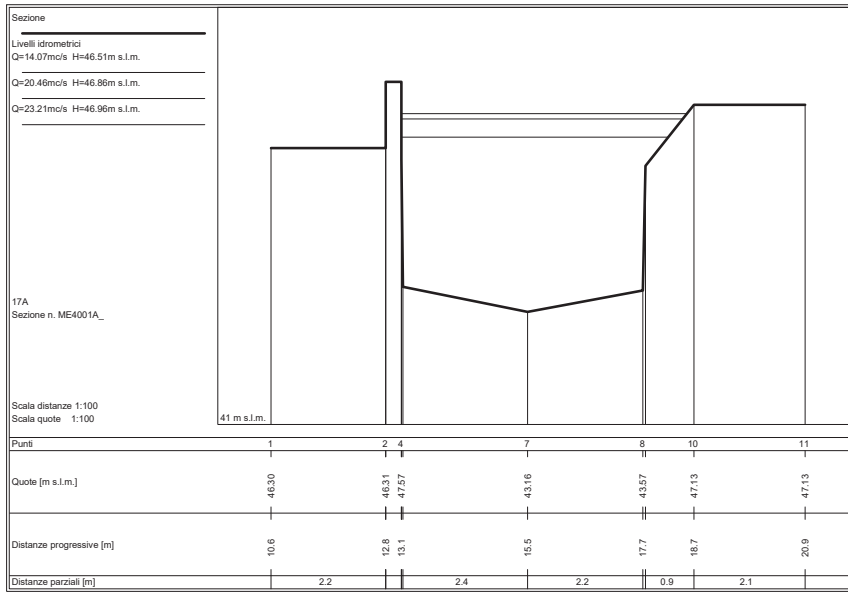

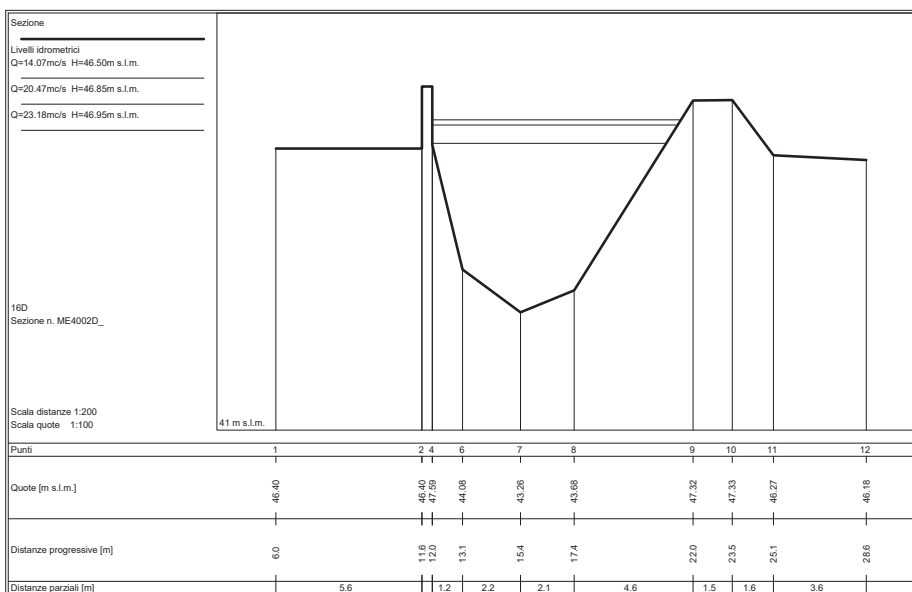
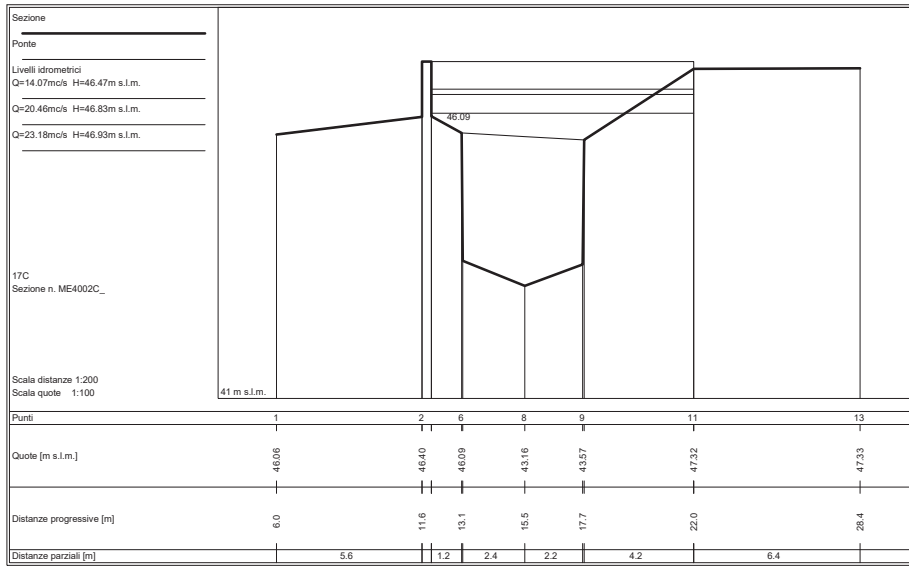

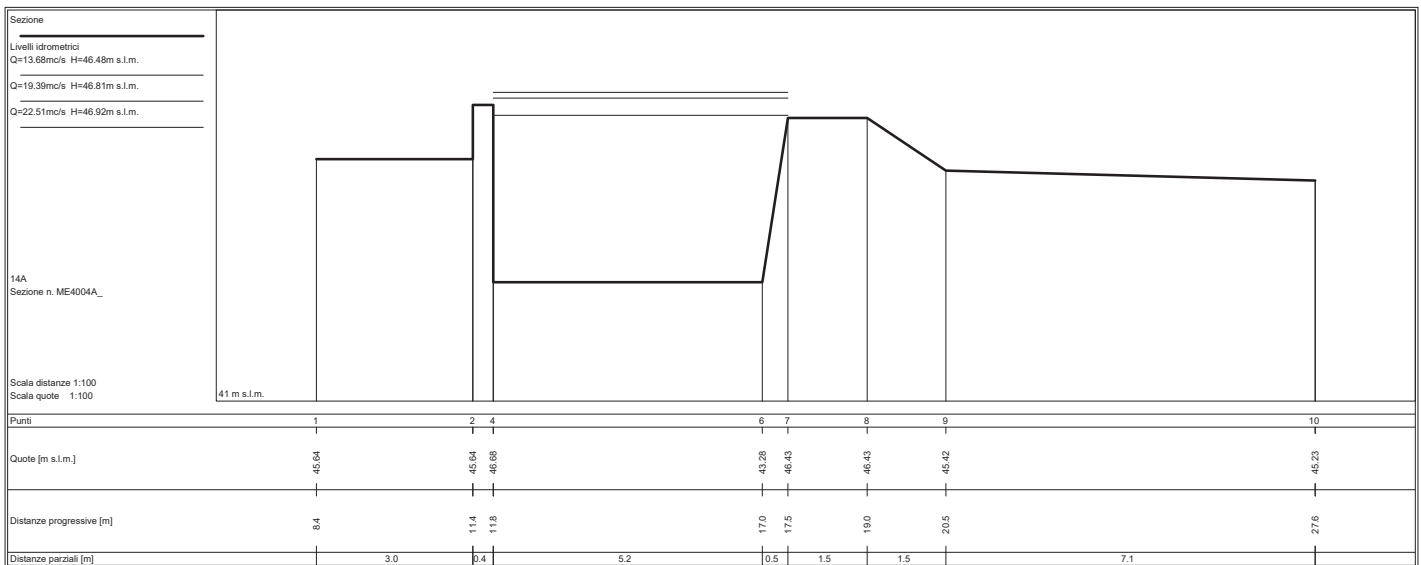
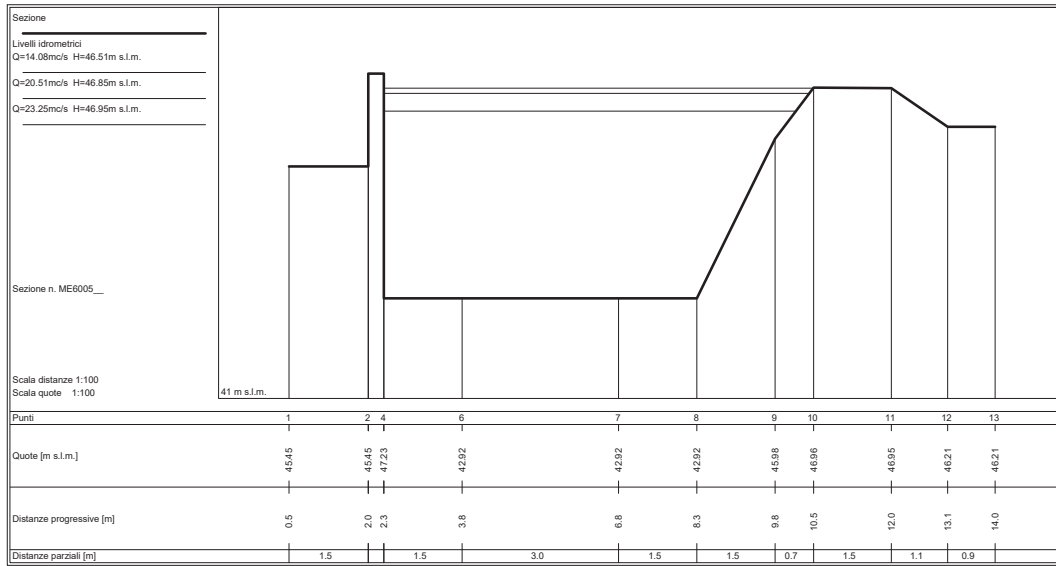



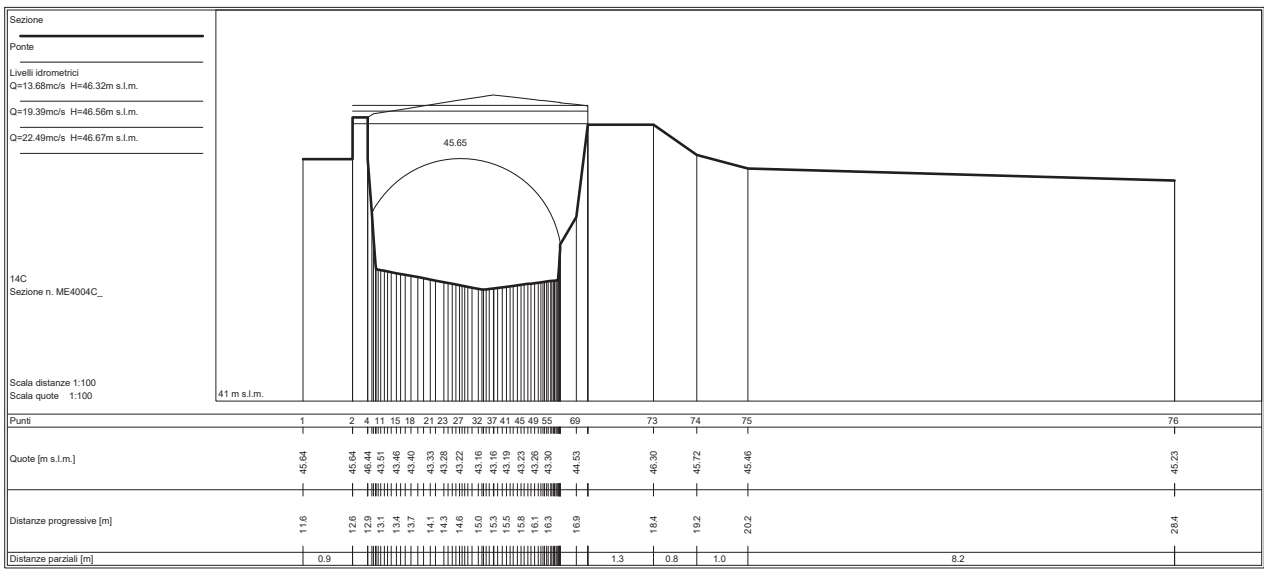
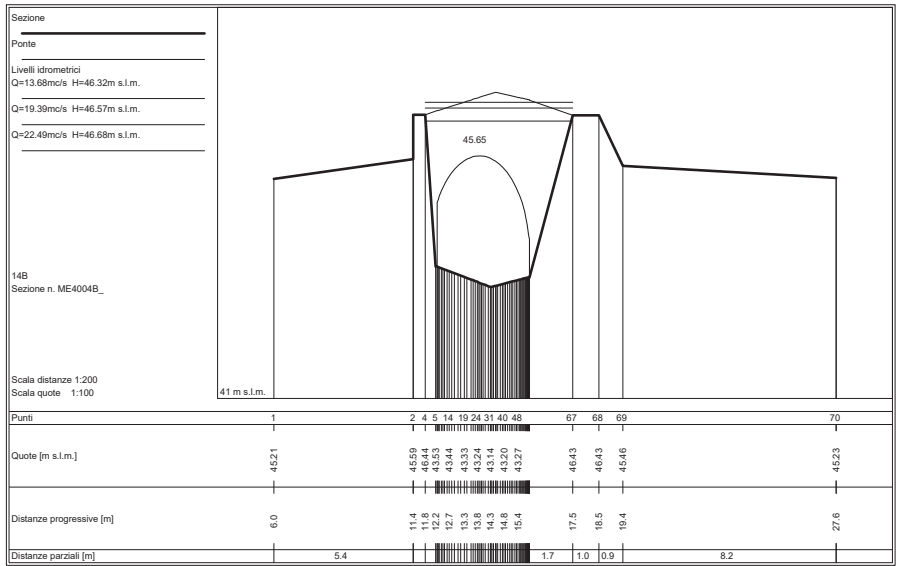

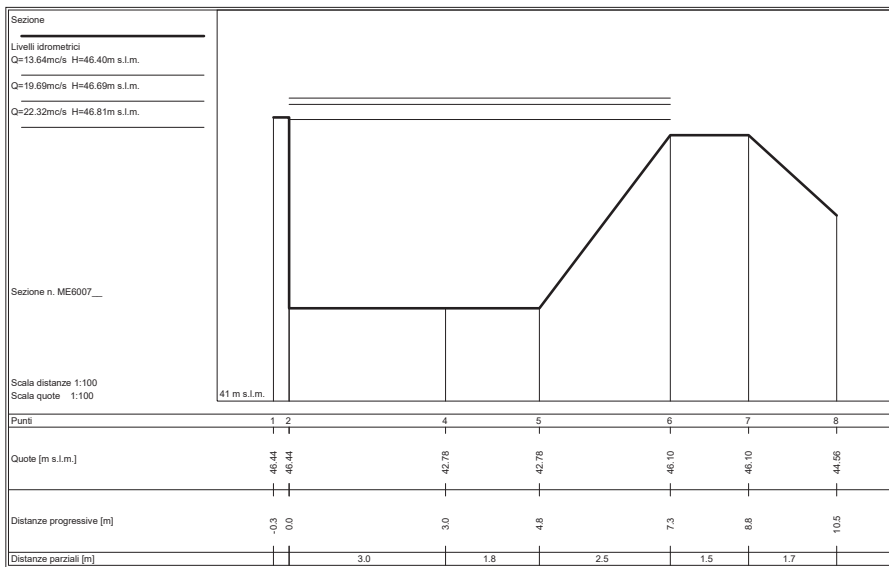
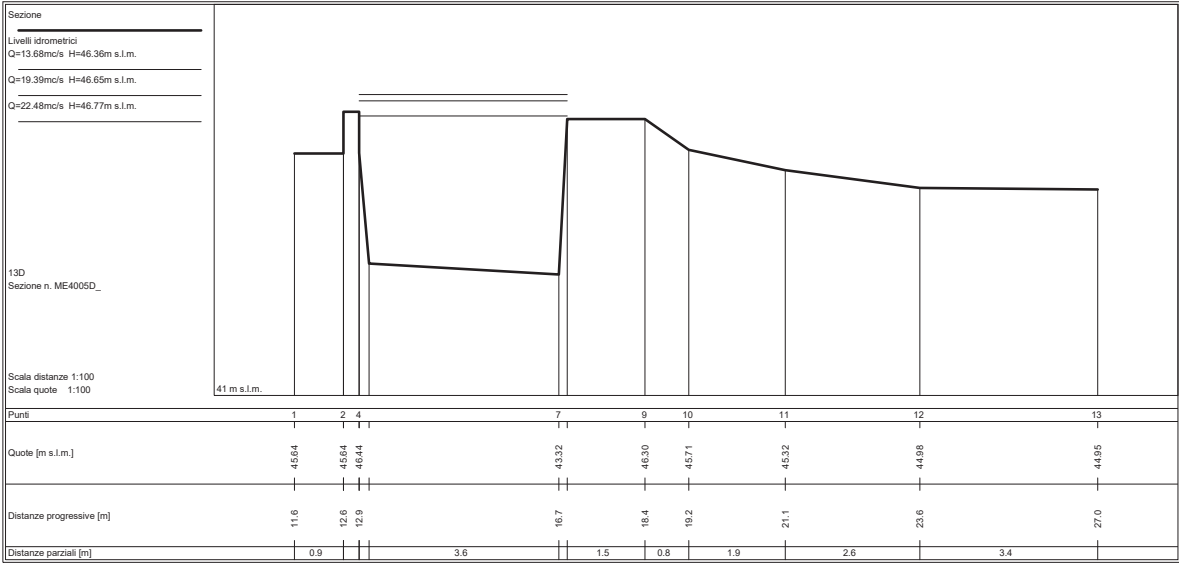

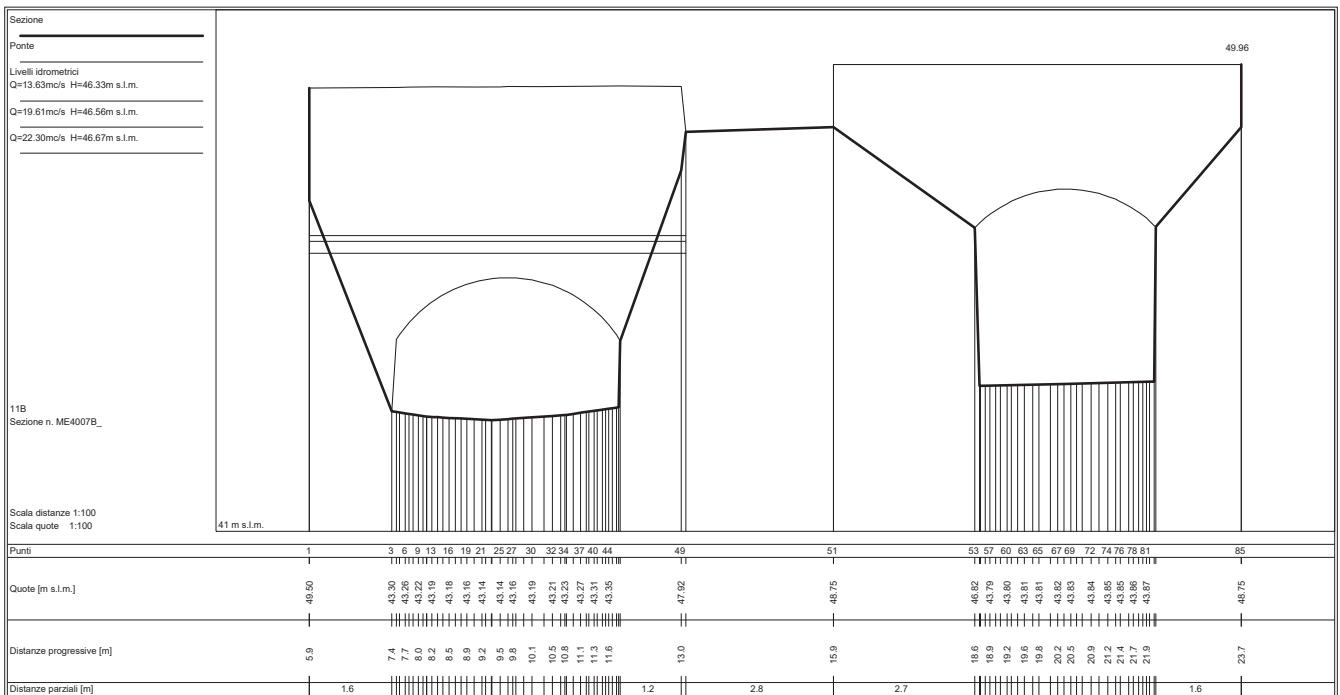
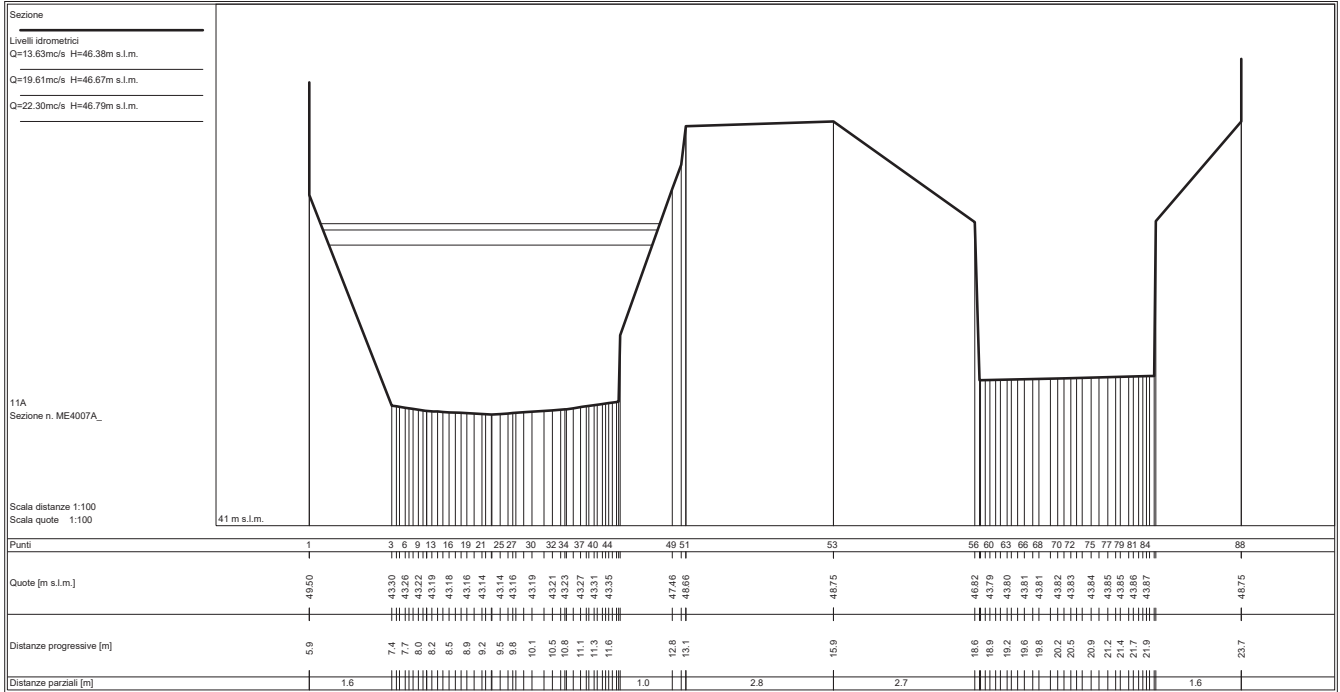

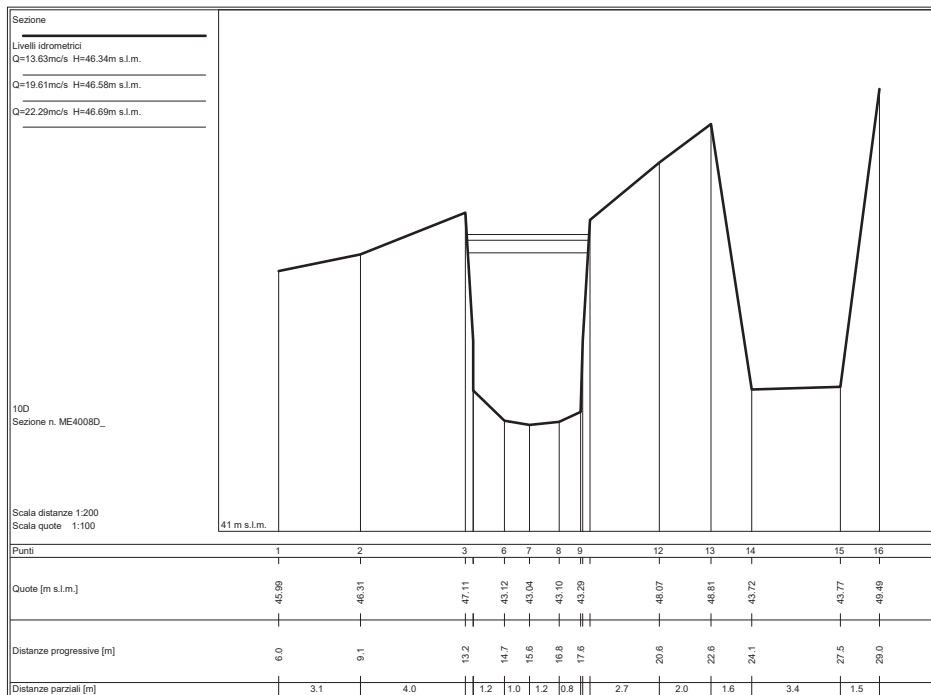
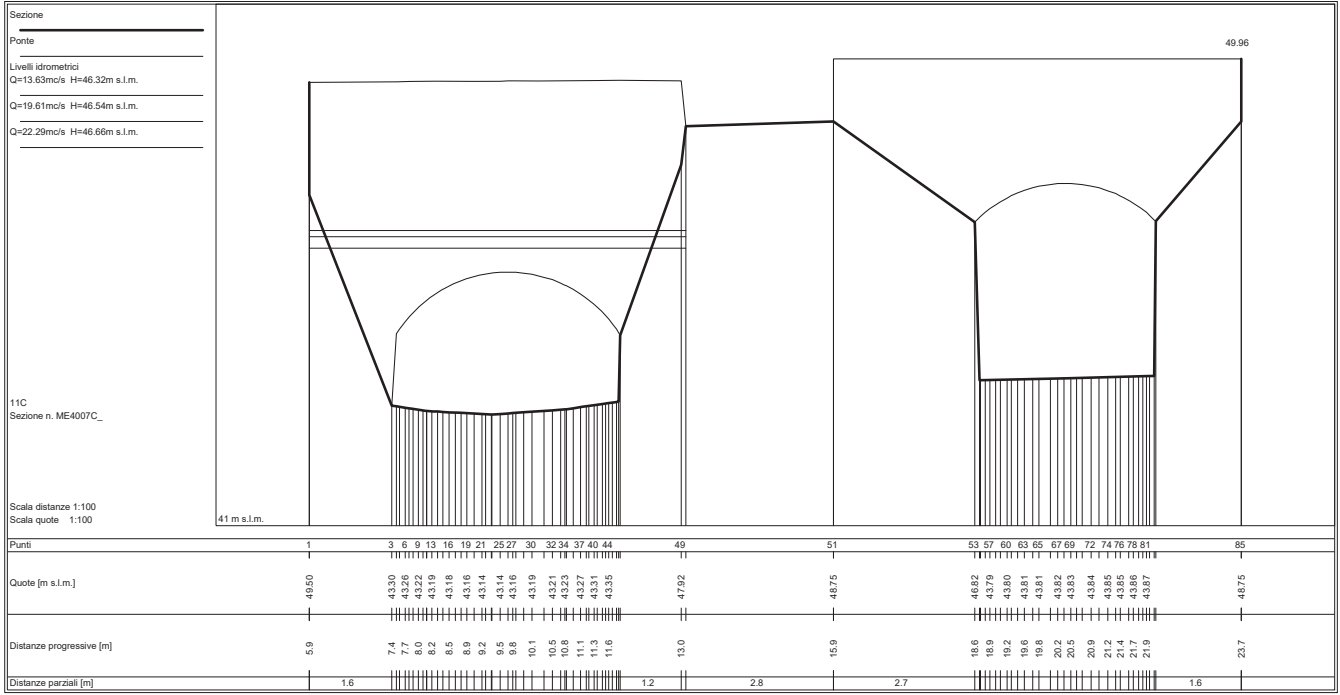

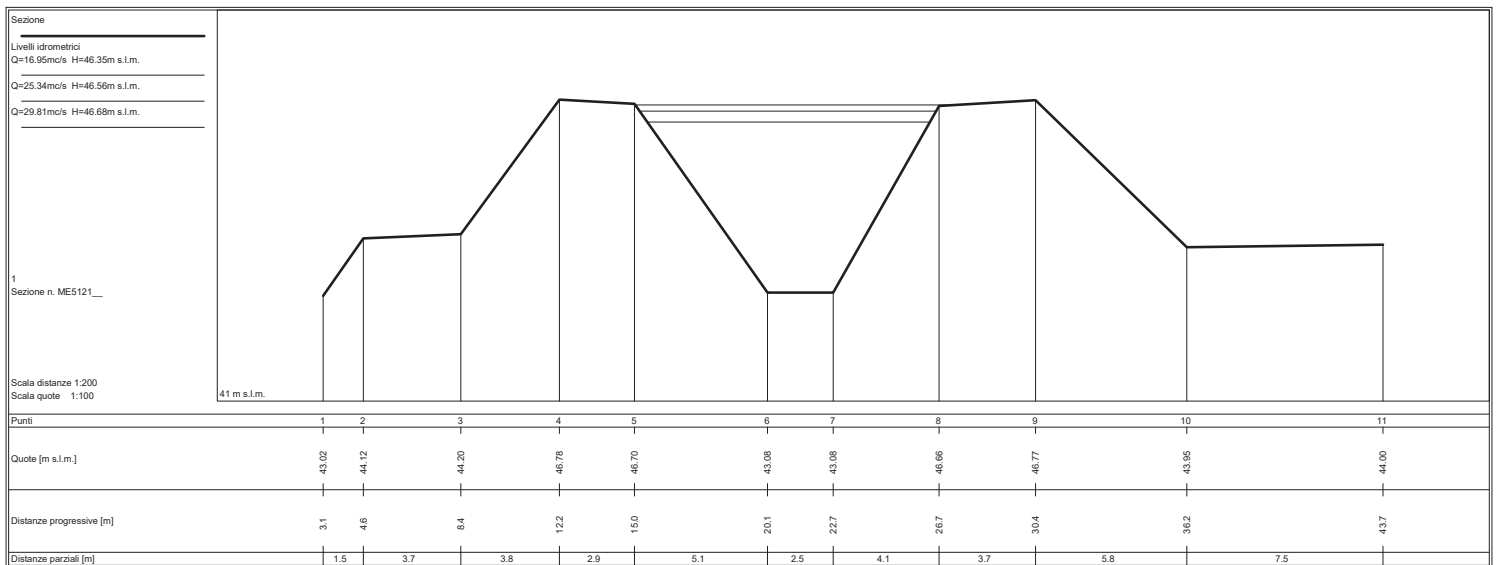
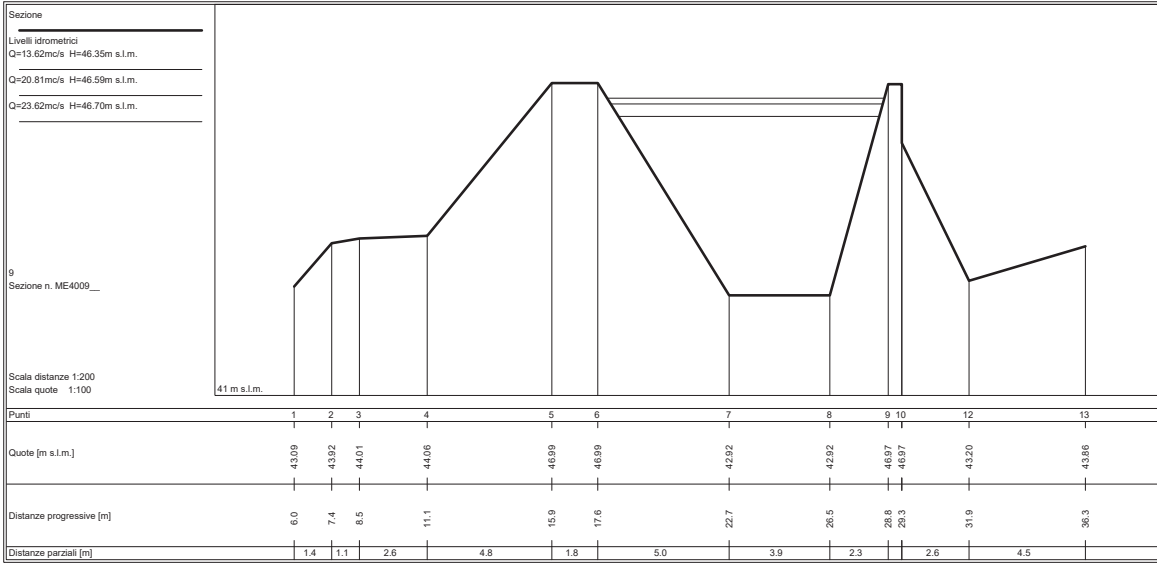

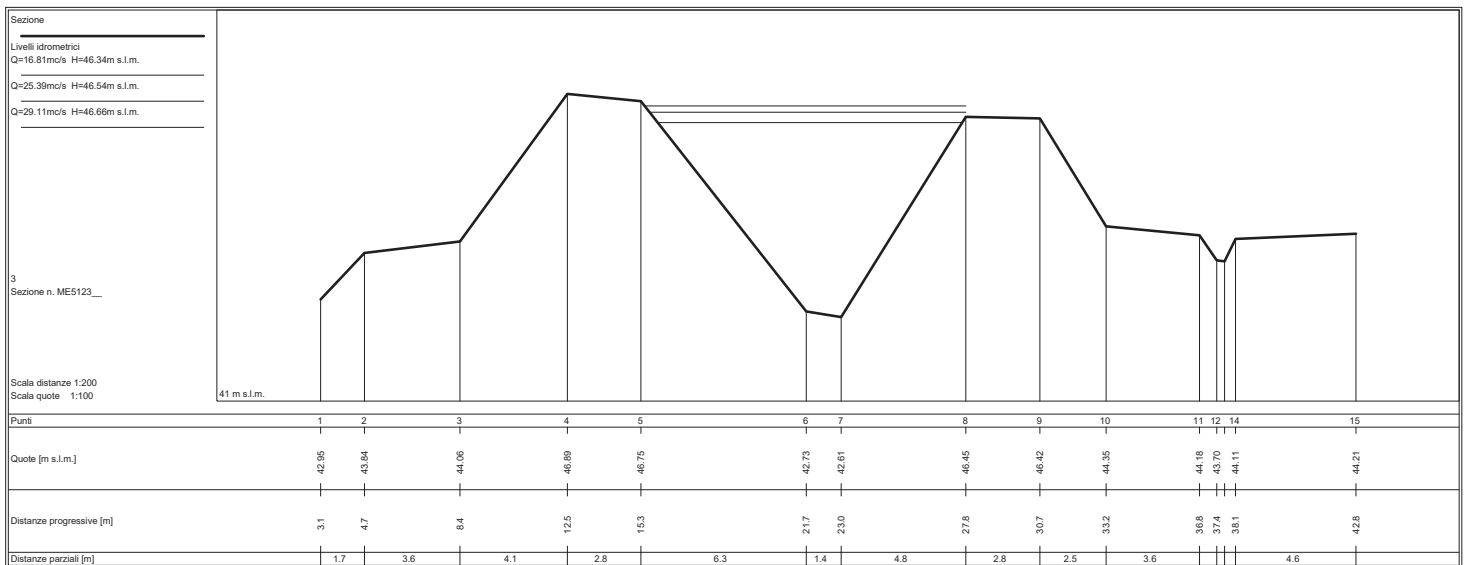
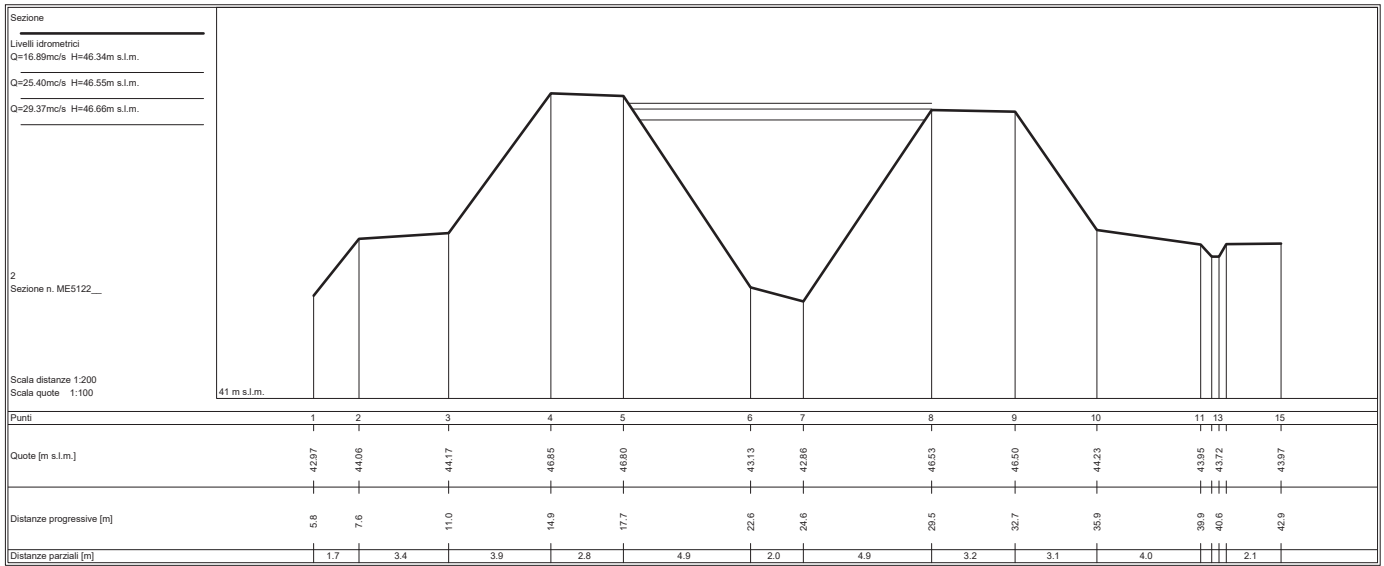

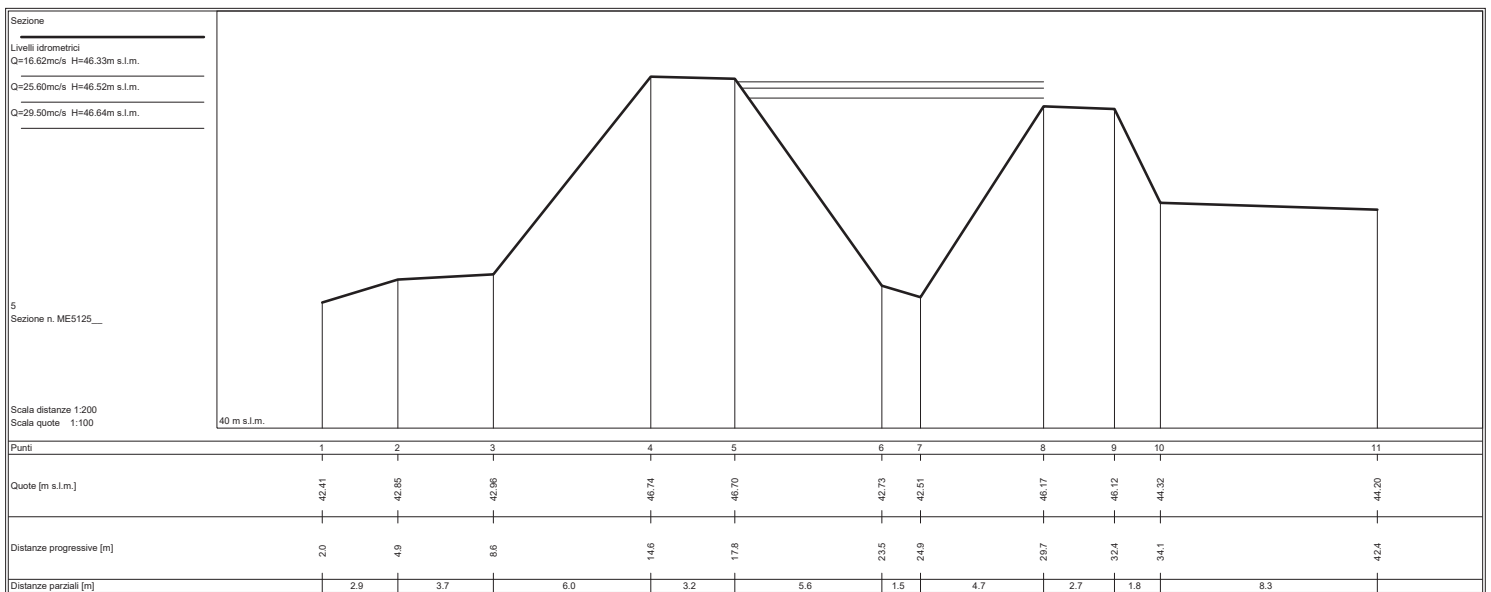
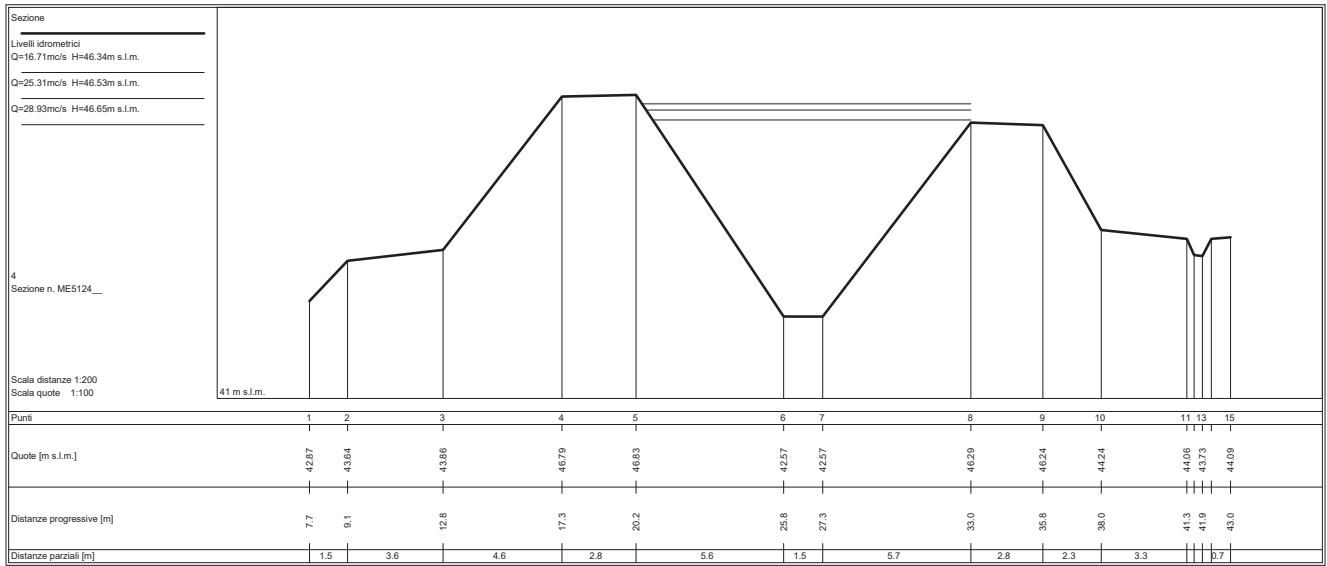

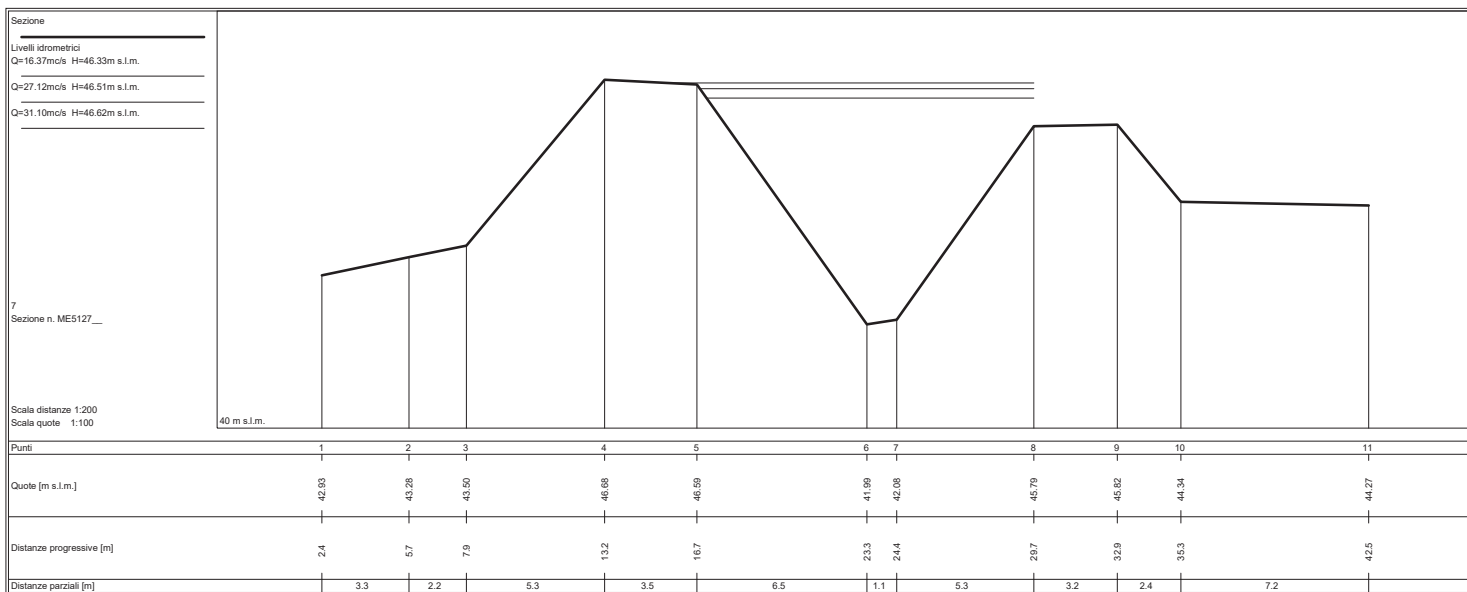
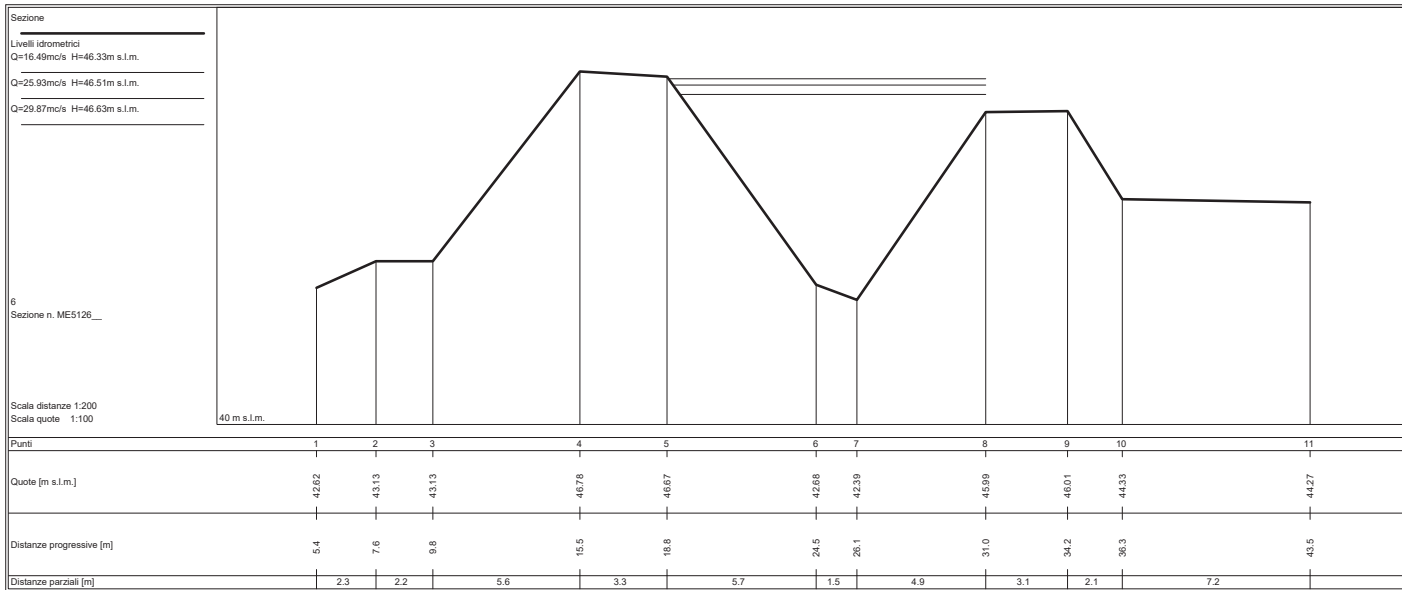



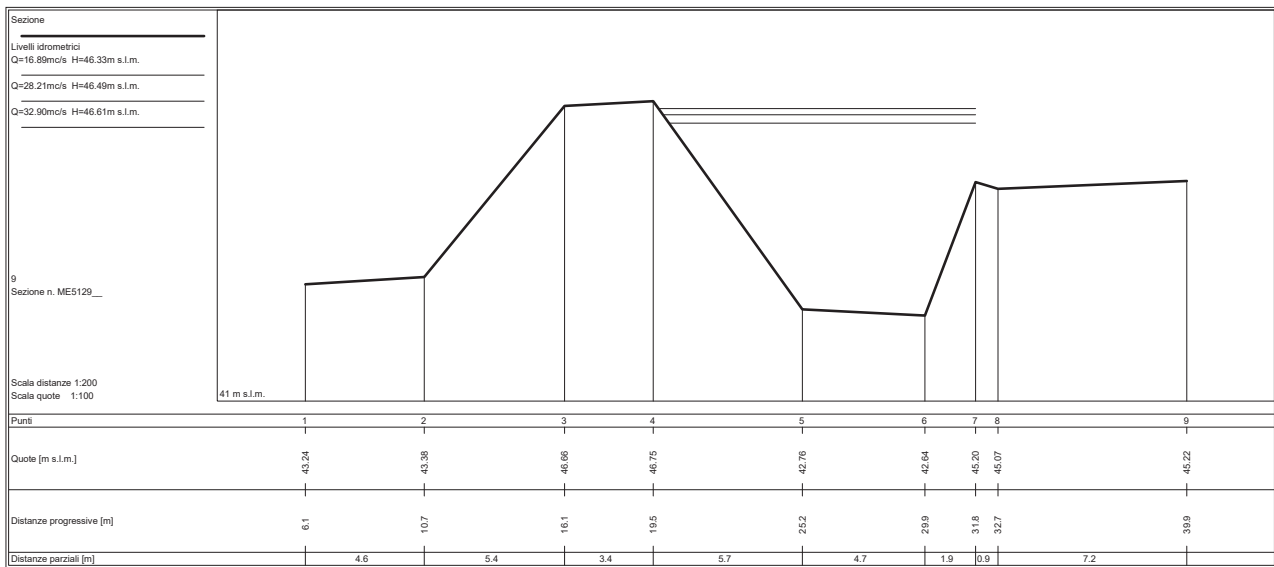
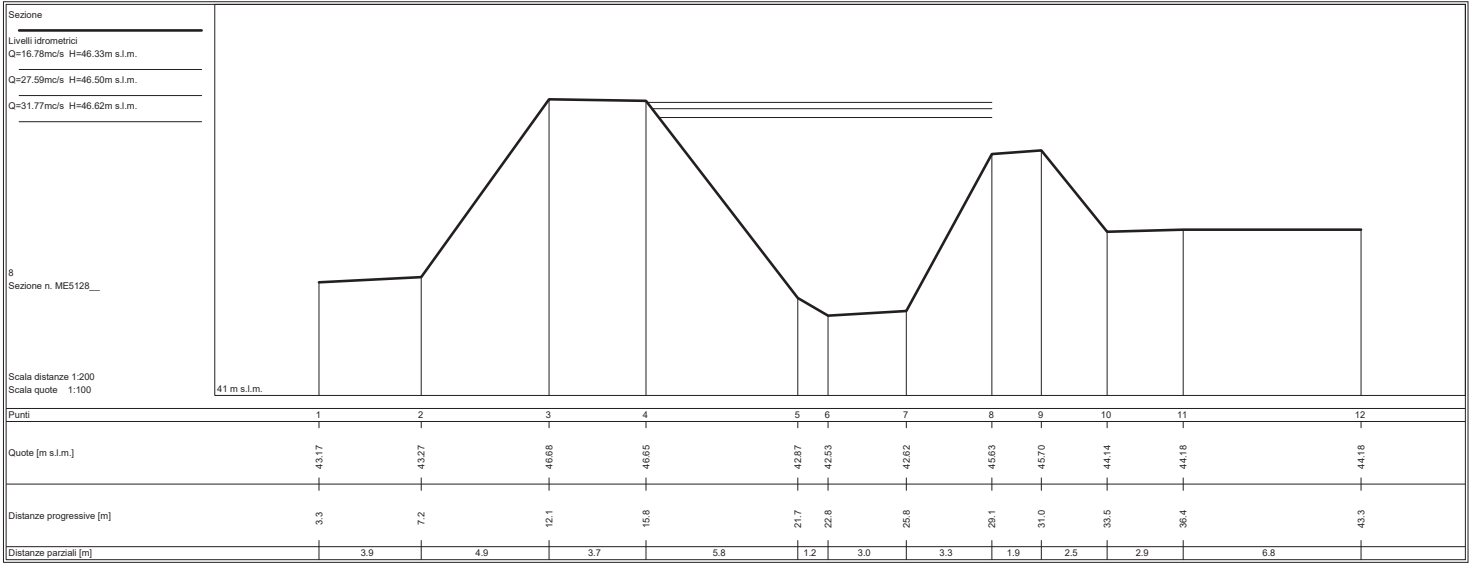

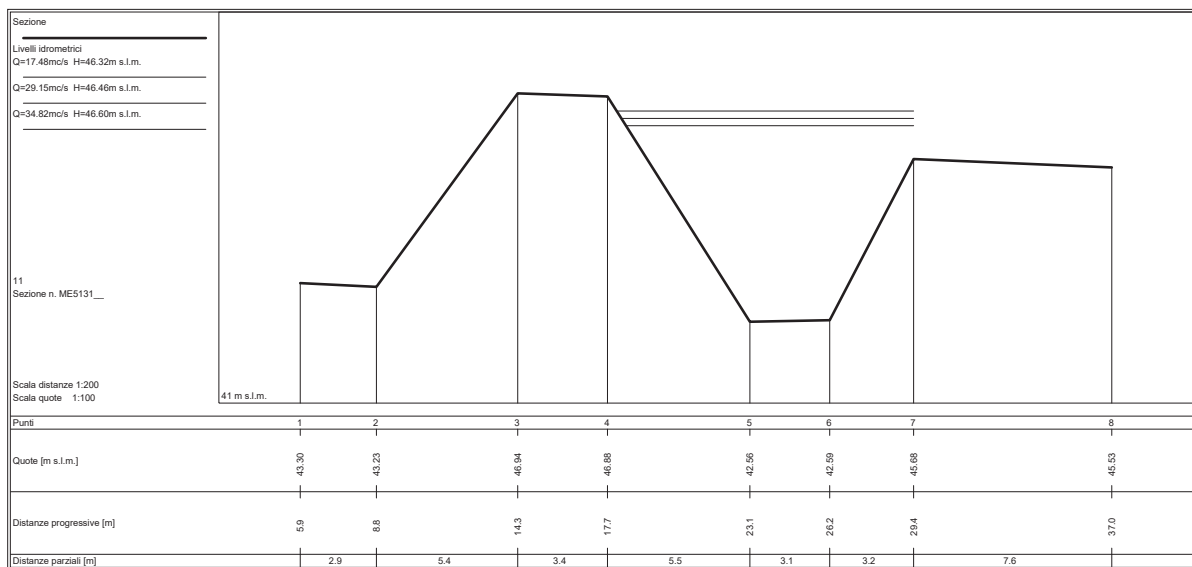
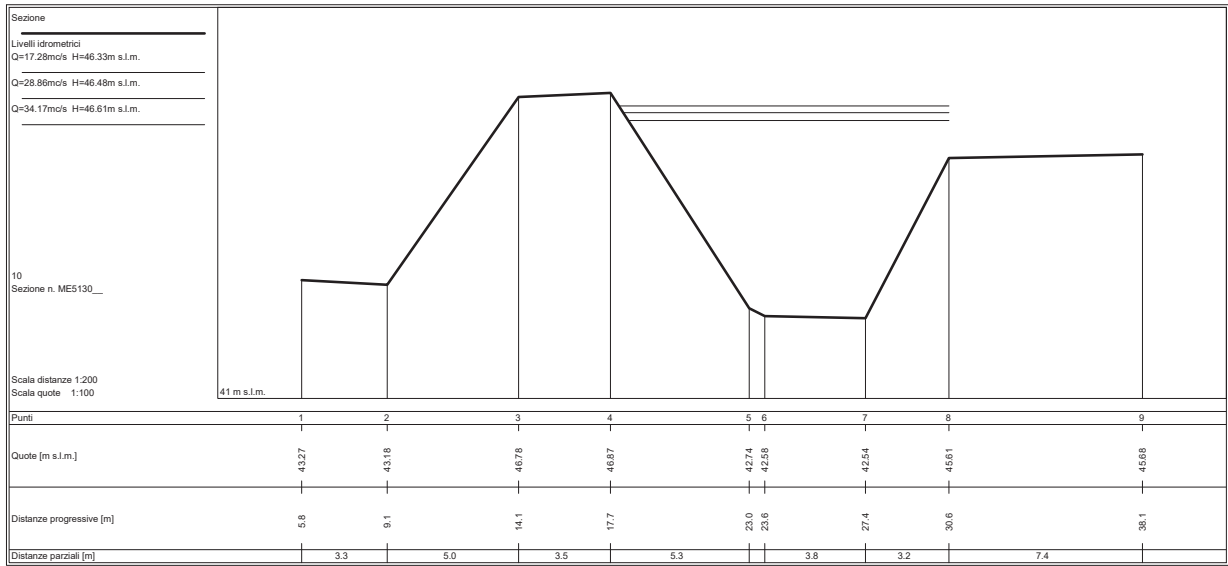

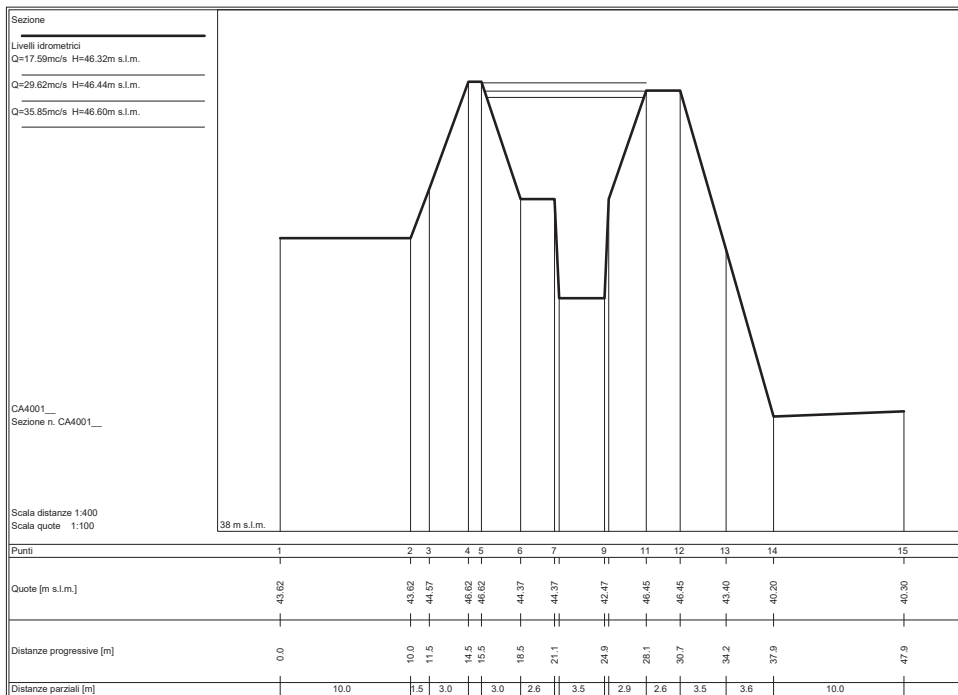
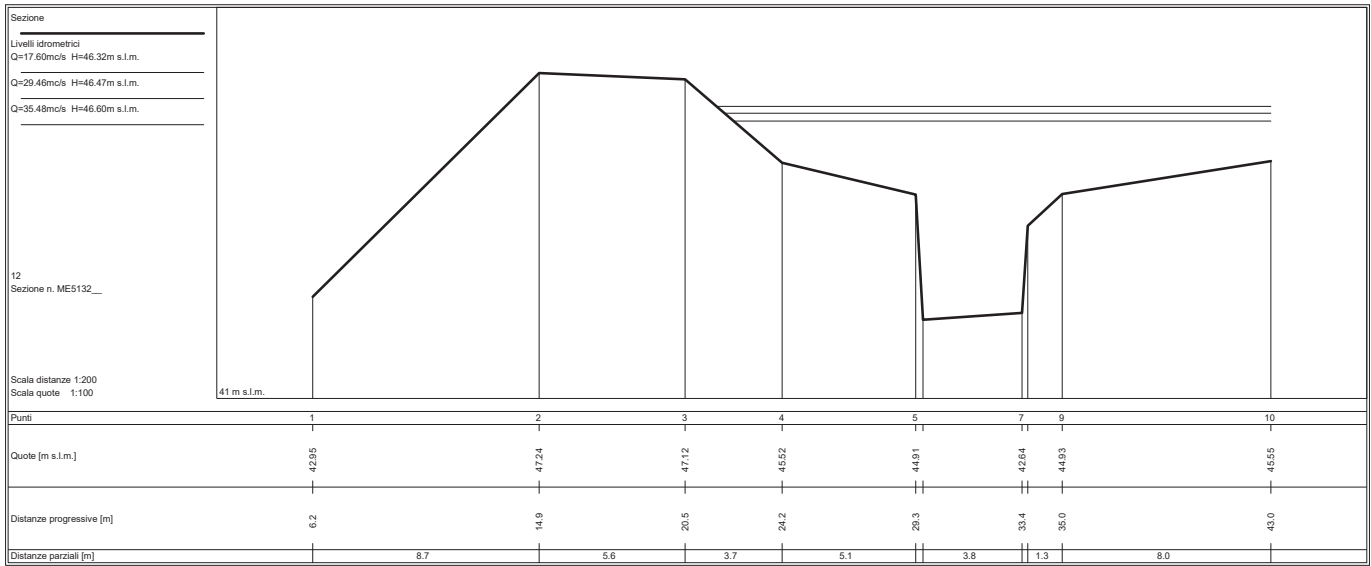

SEZIONI FLUVIALI  
FOSSO POLTROVA

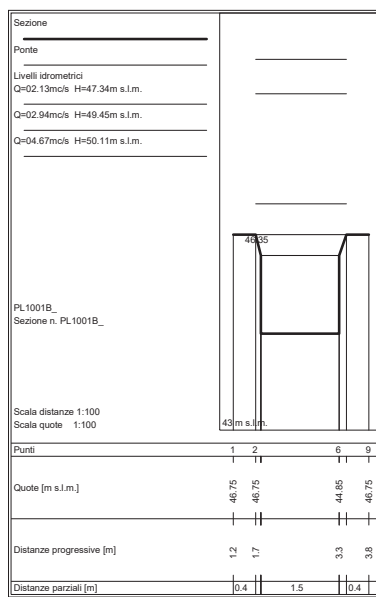
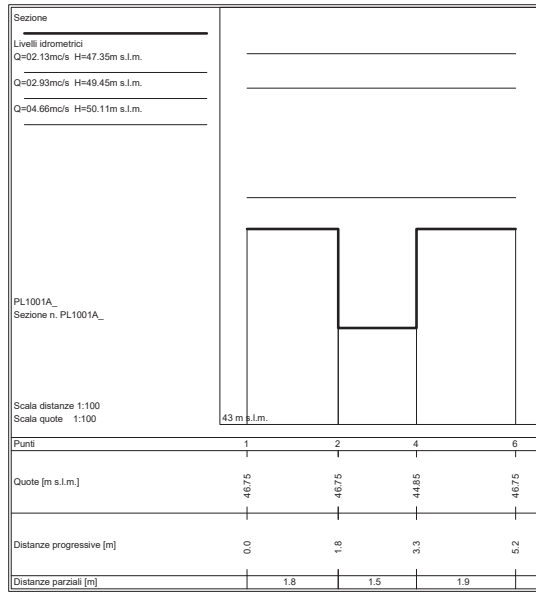

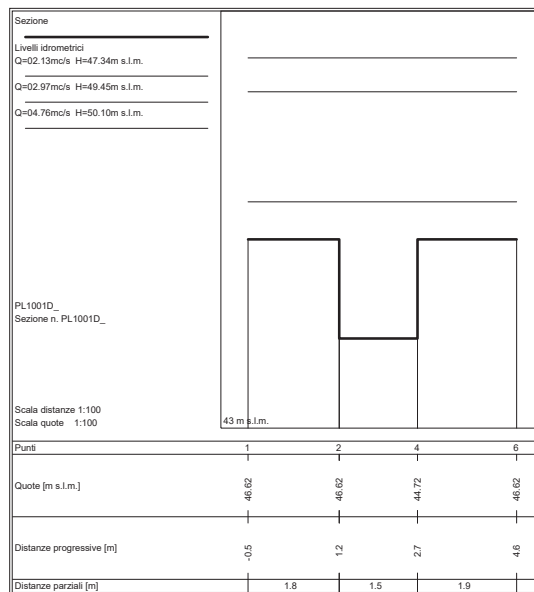
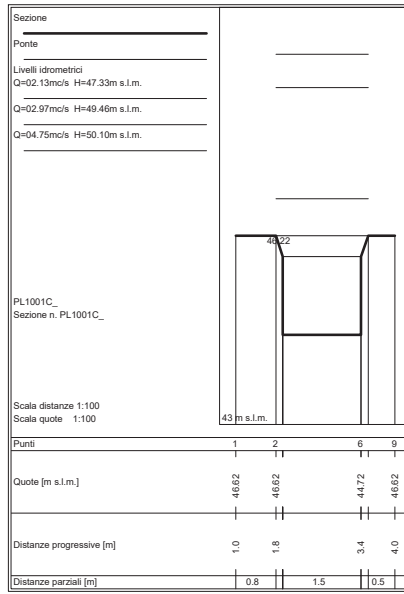

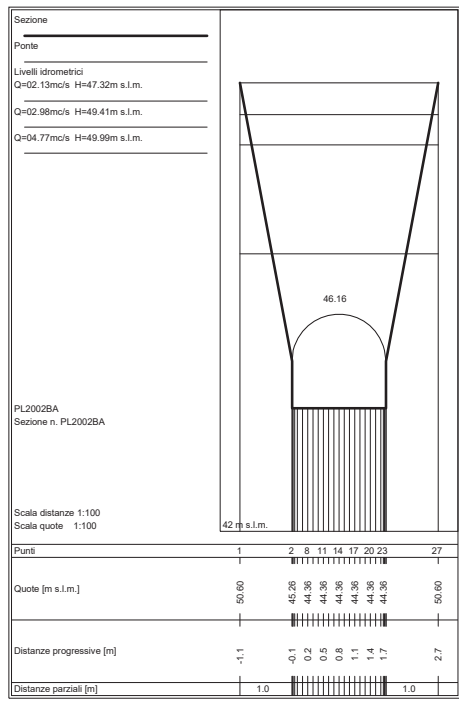
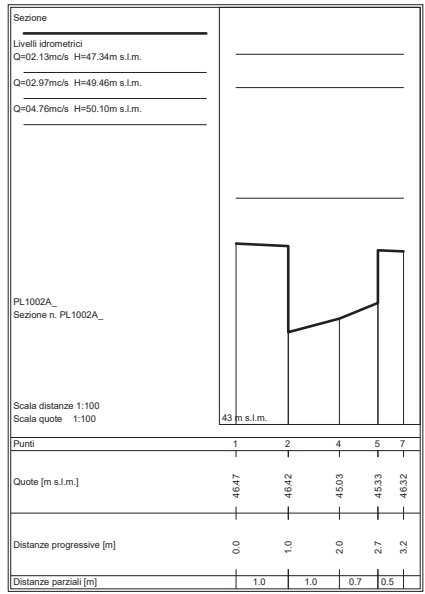

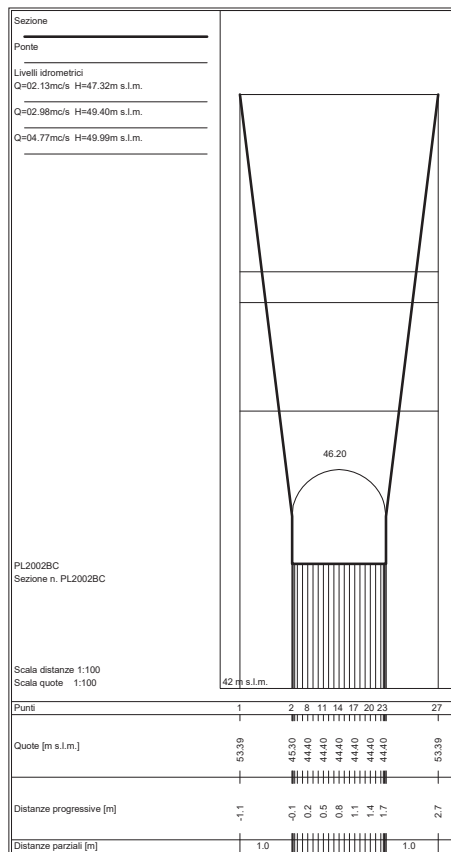
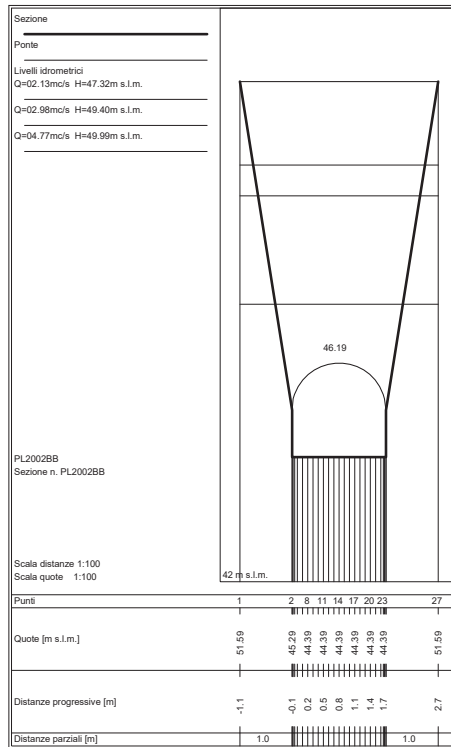



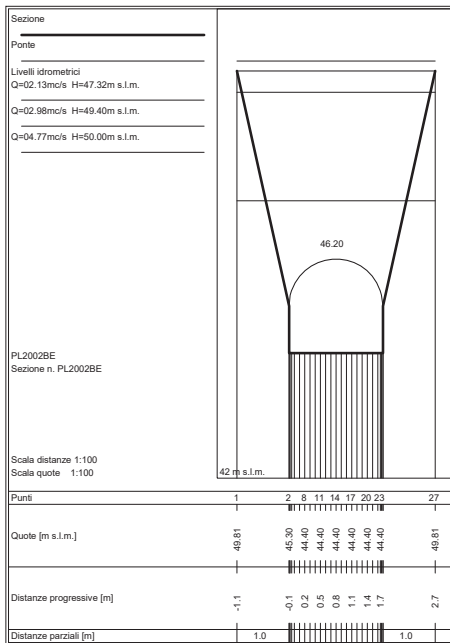
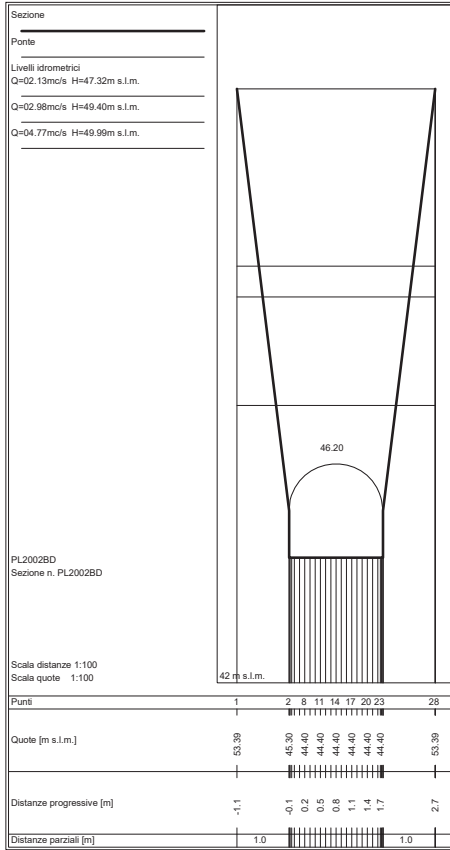

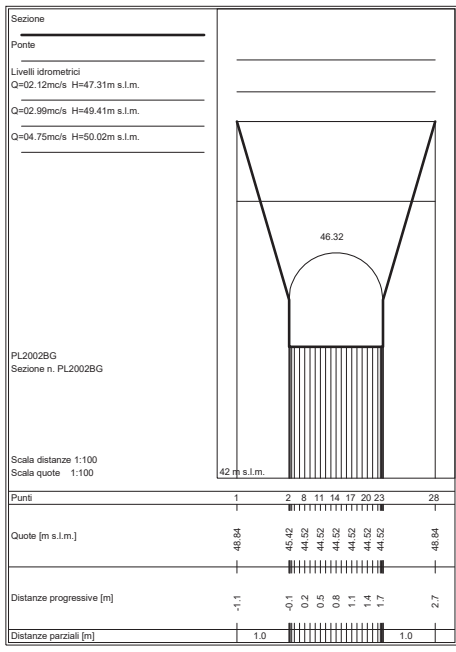
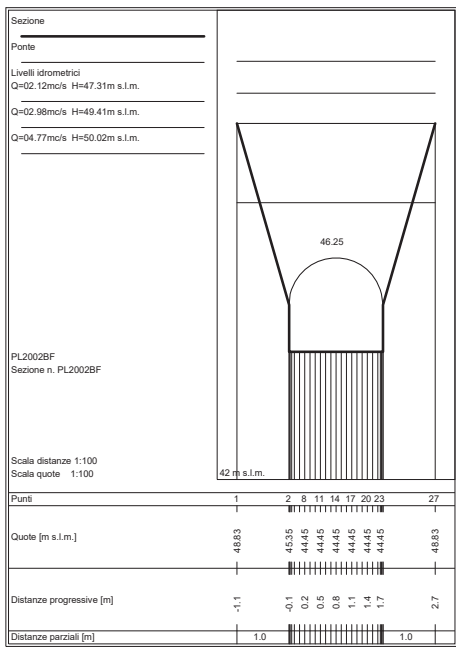

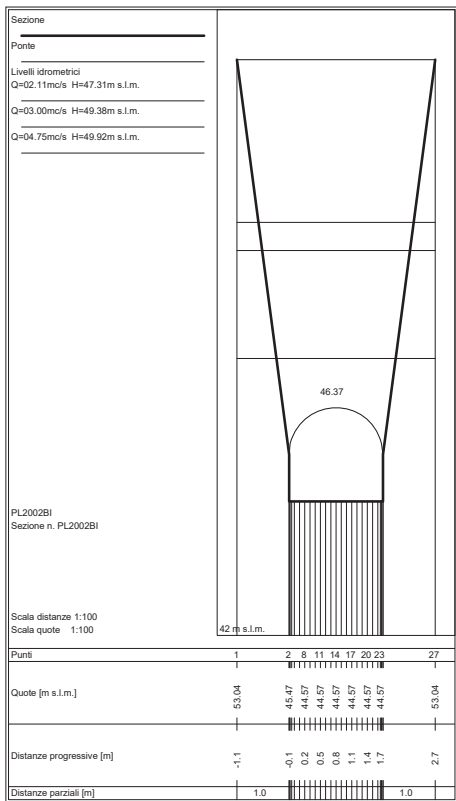
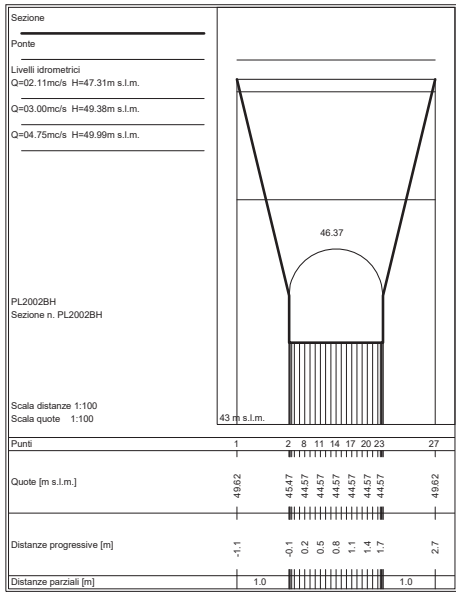

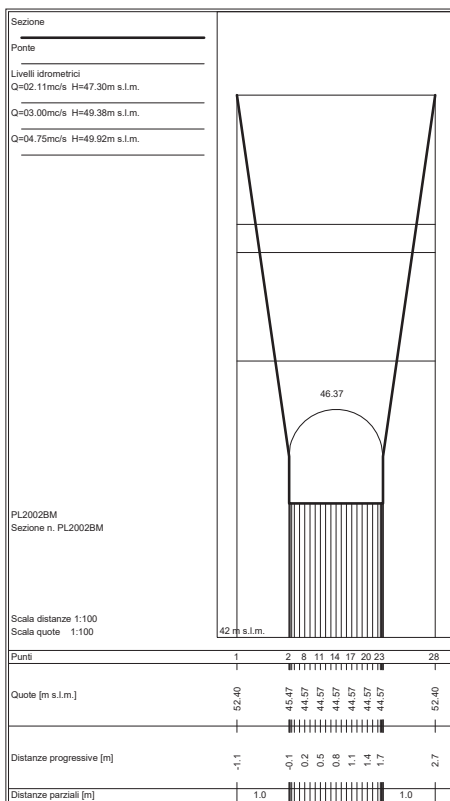
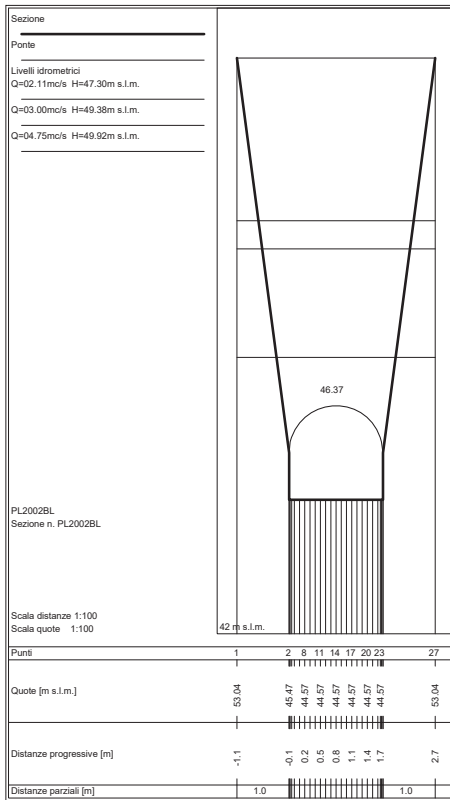

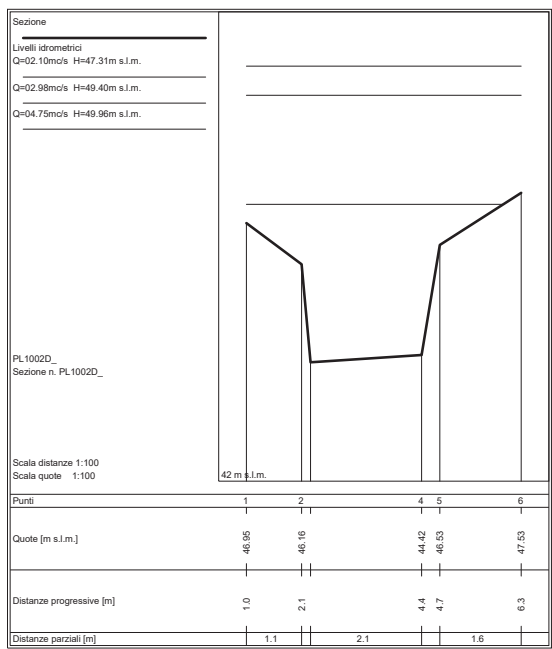
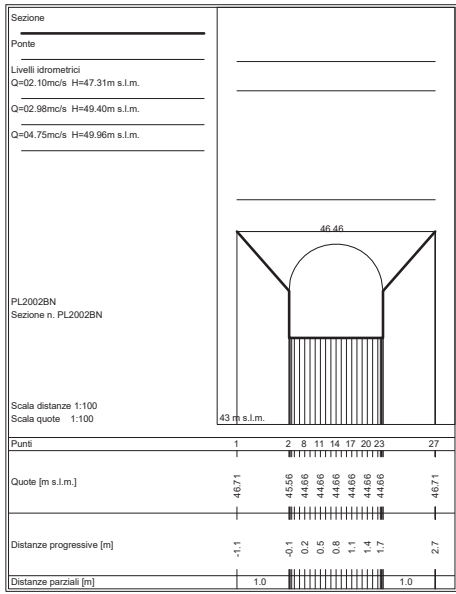

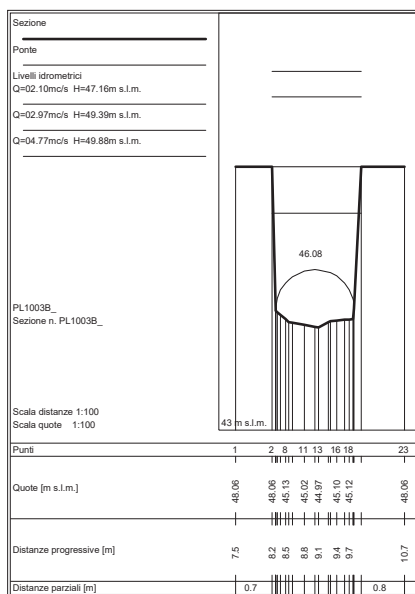
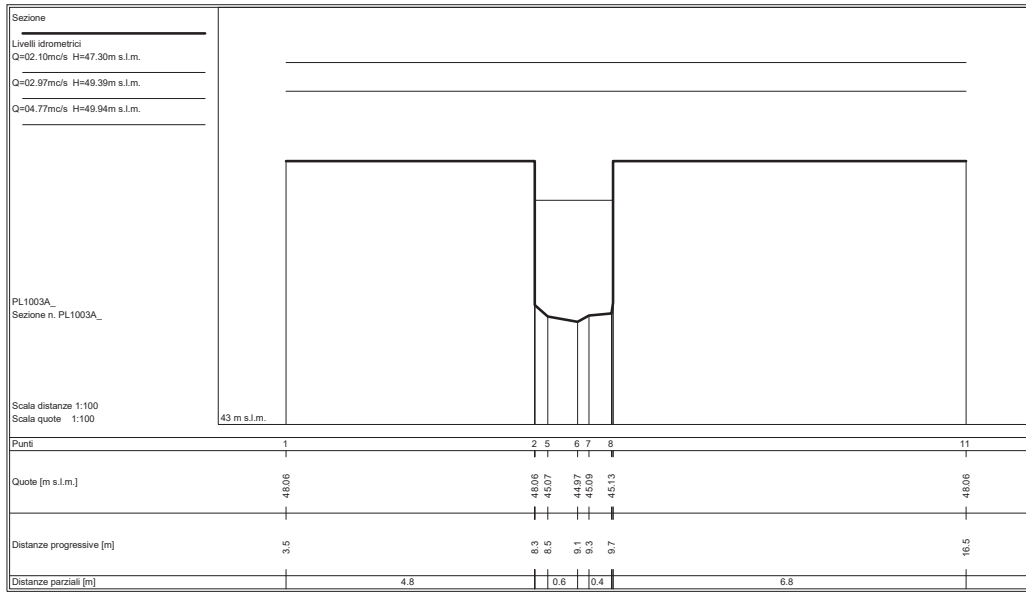

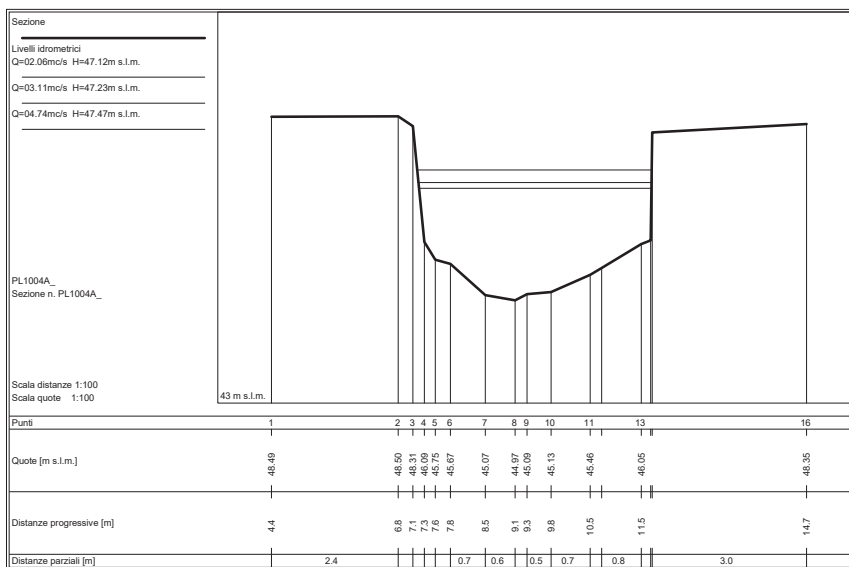
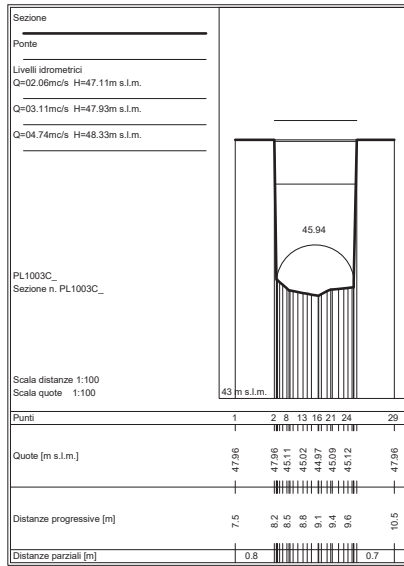

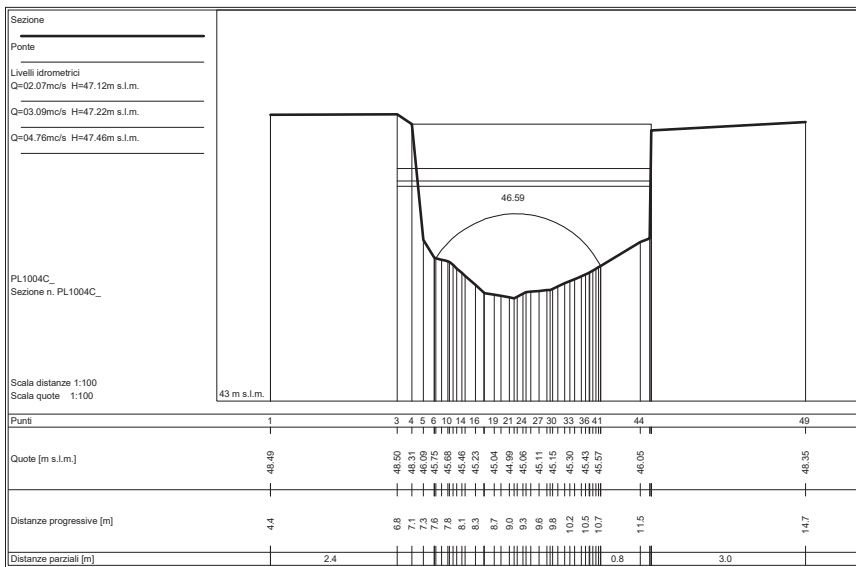
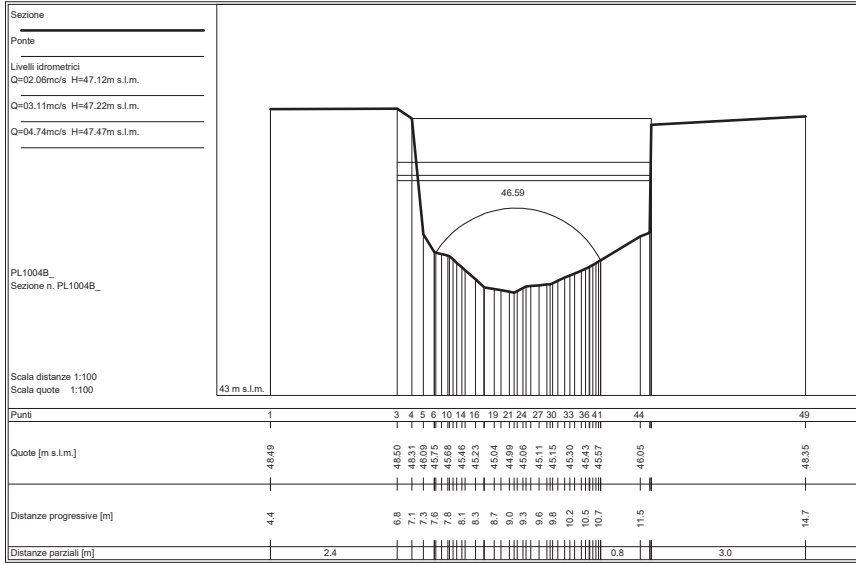



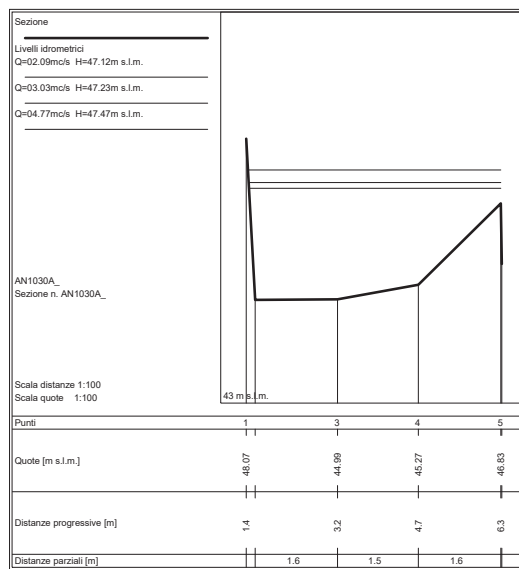
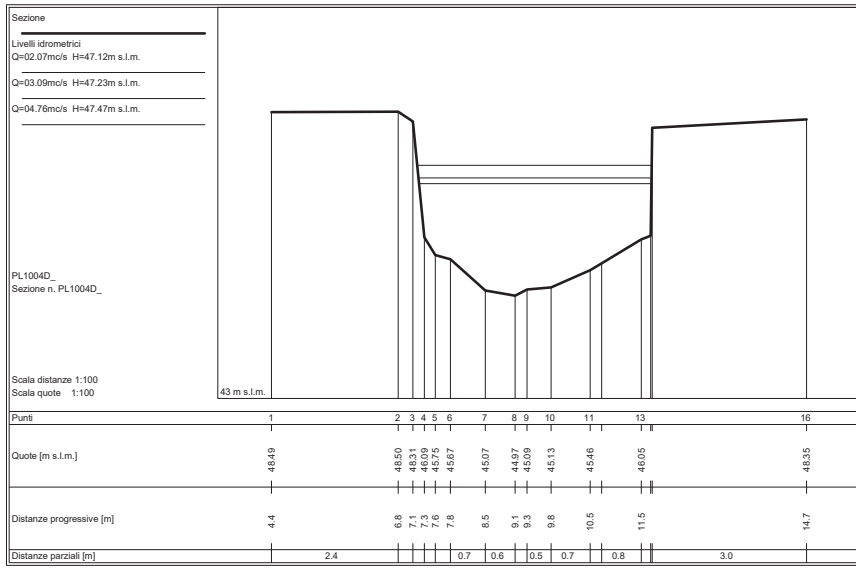

SEZIONI FLUVIALI  
FOSSO SELVAVECCHIA

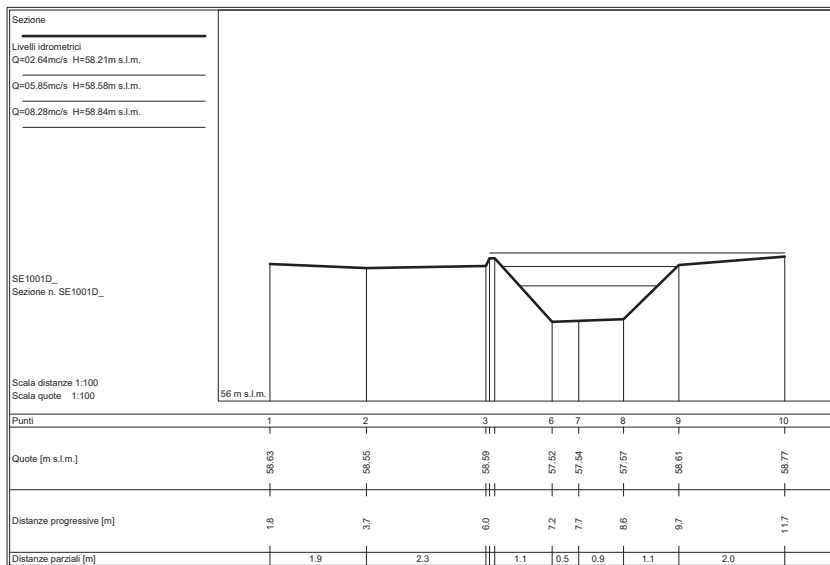
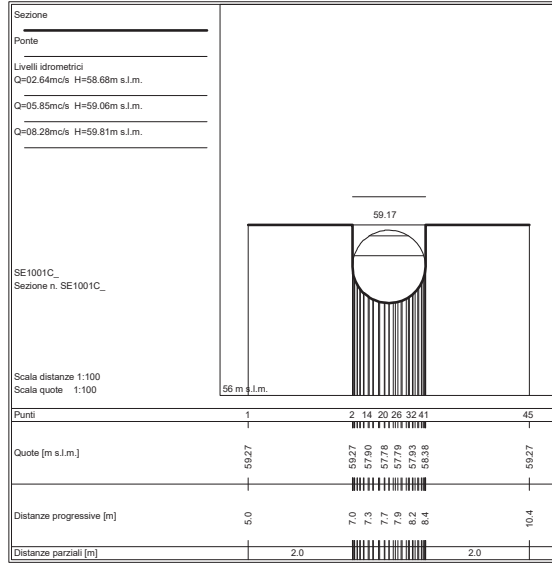

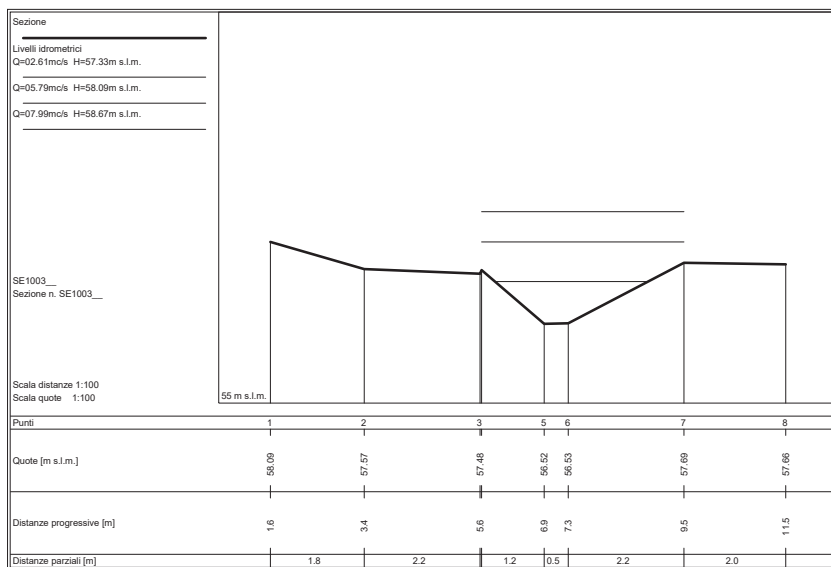
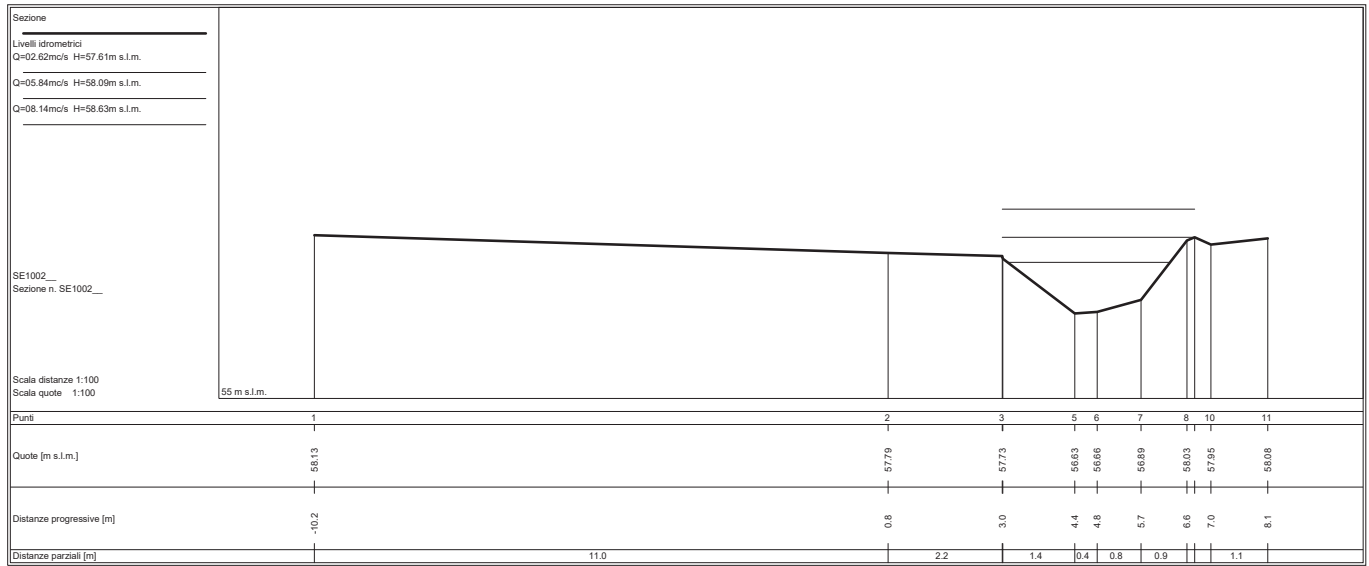

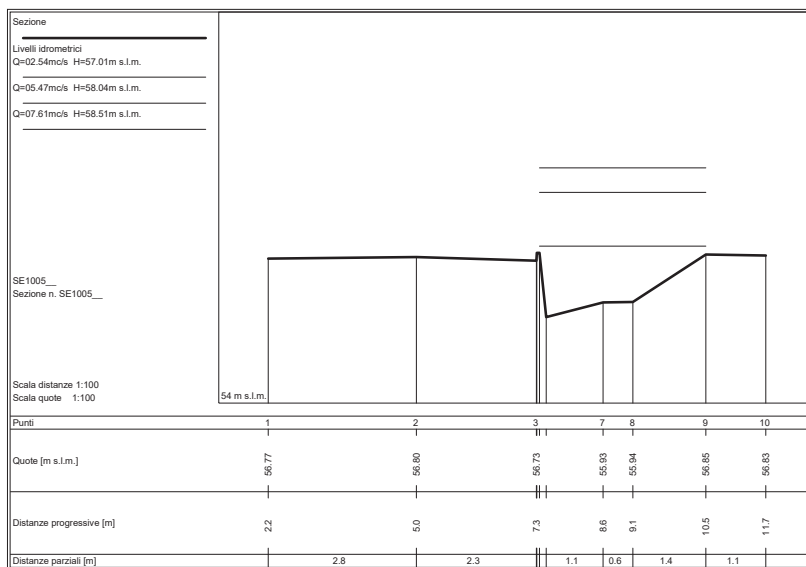
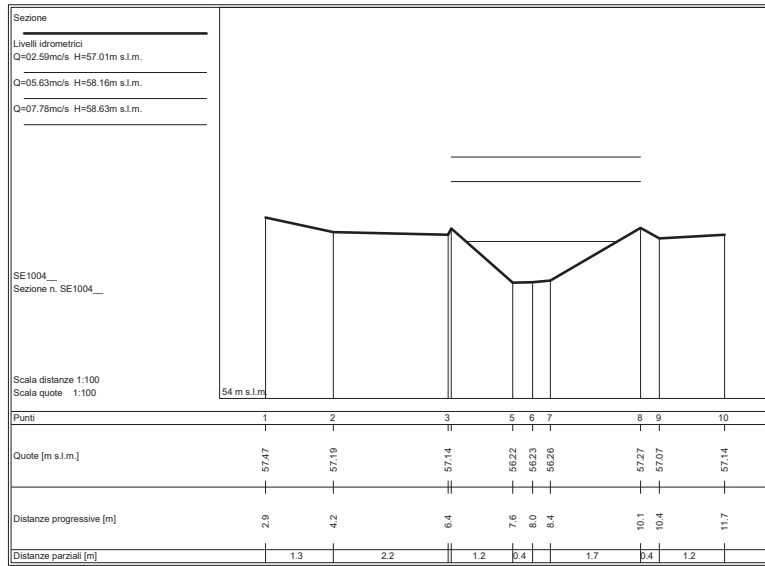

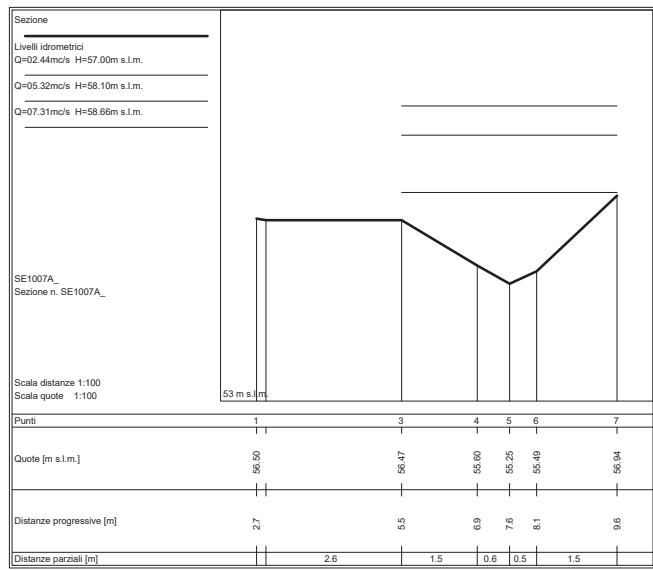
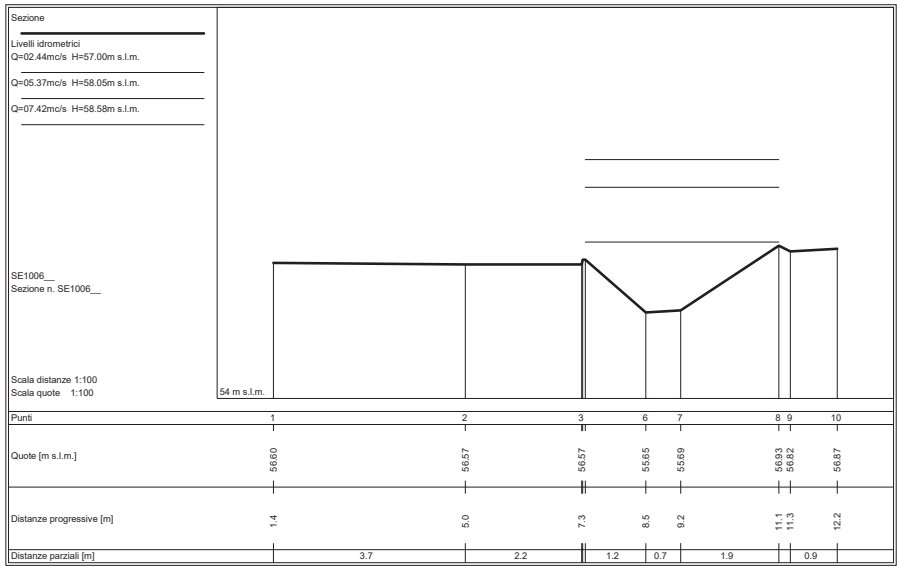

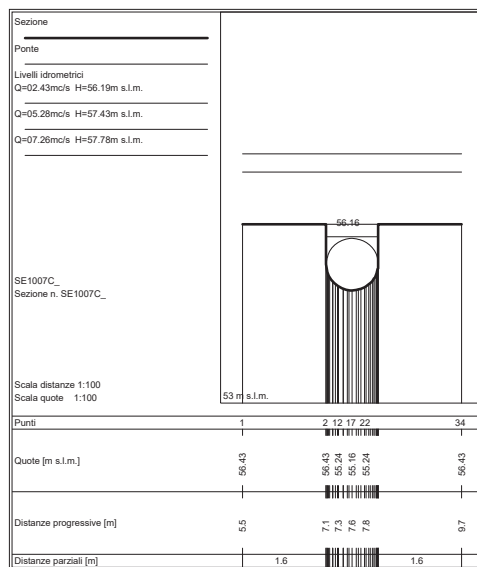
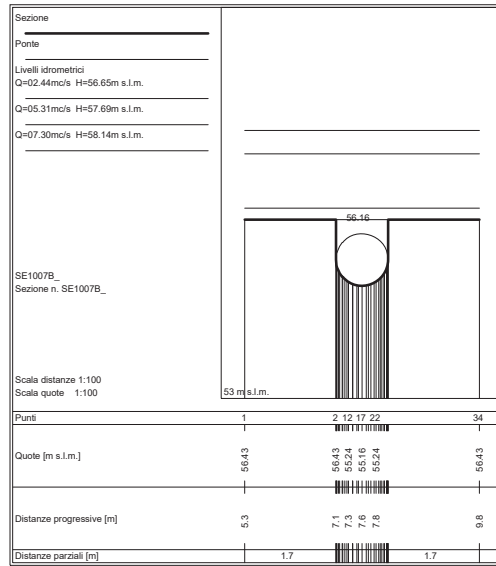

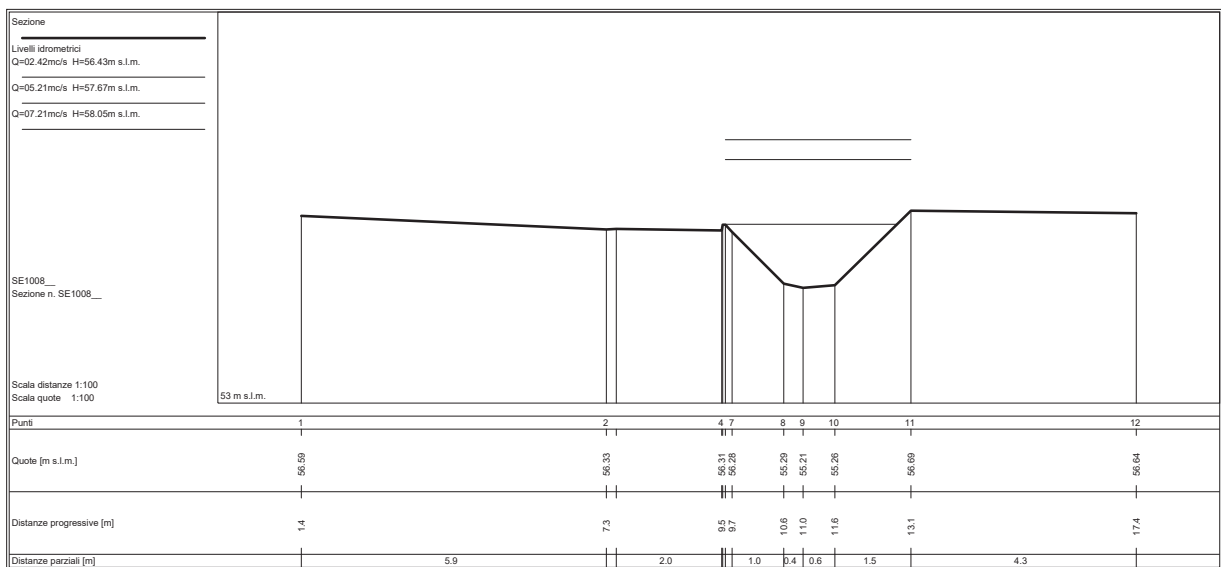
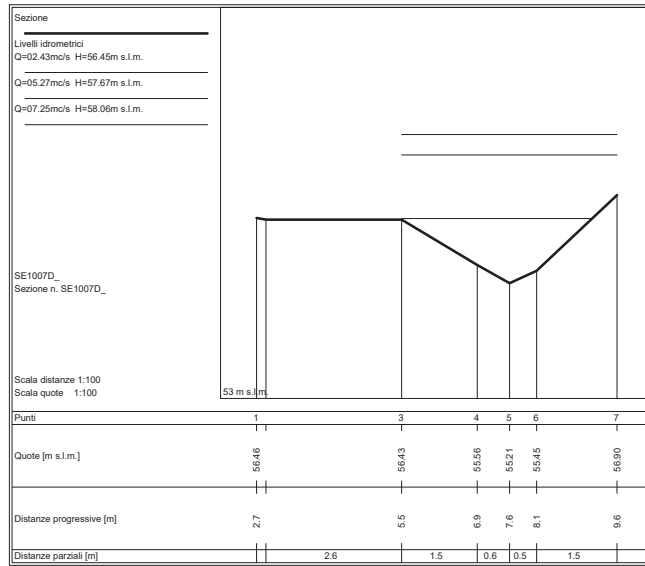



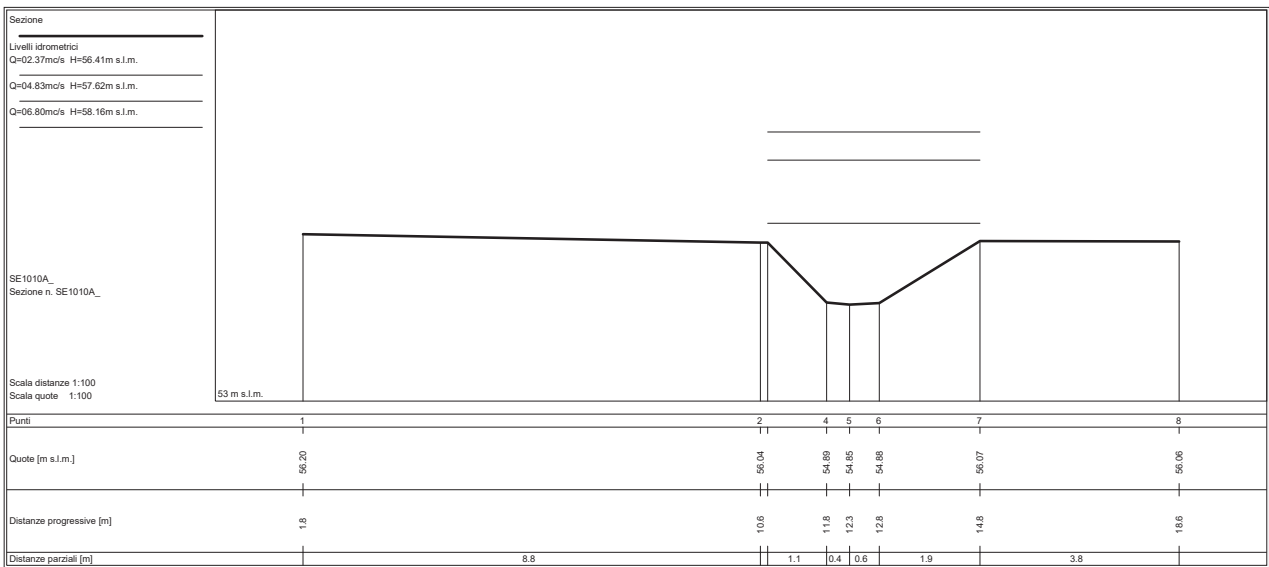
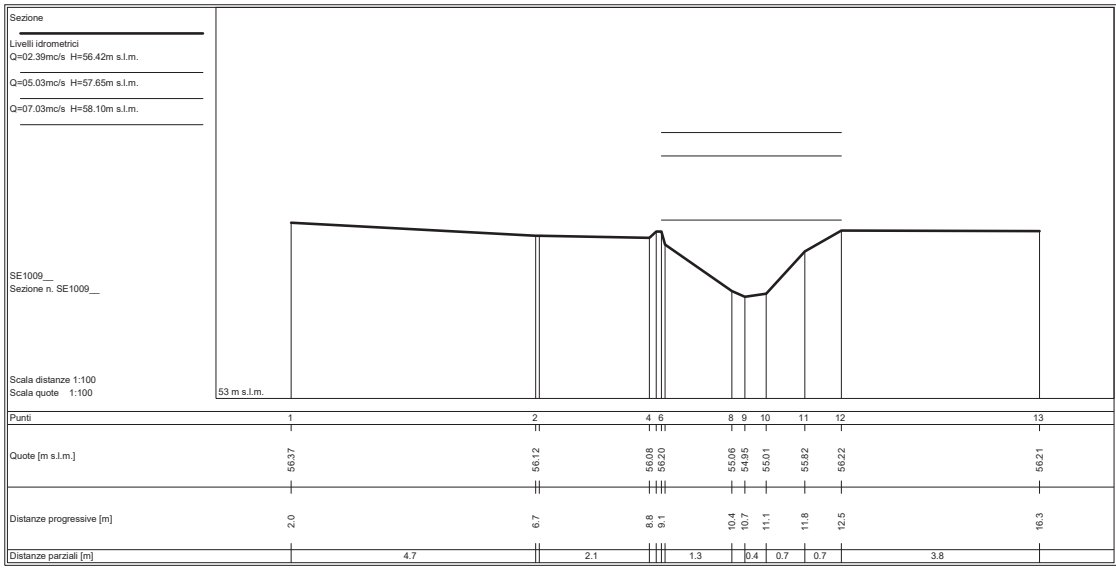

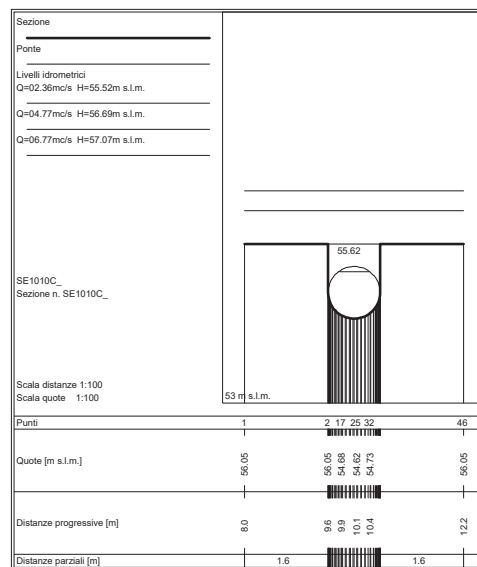
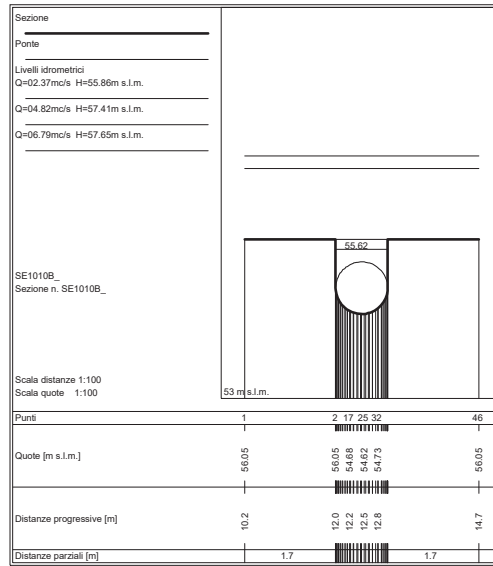

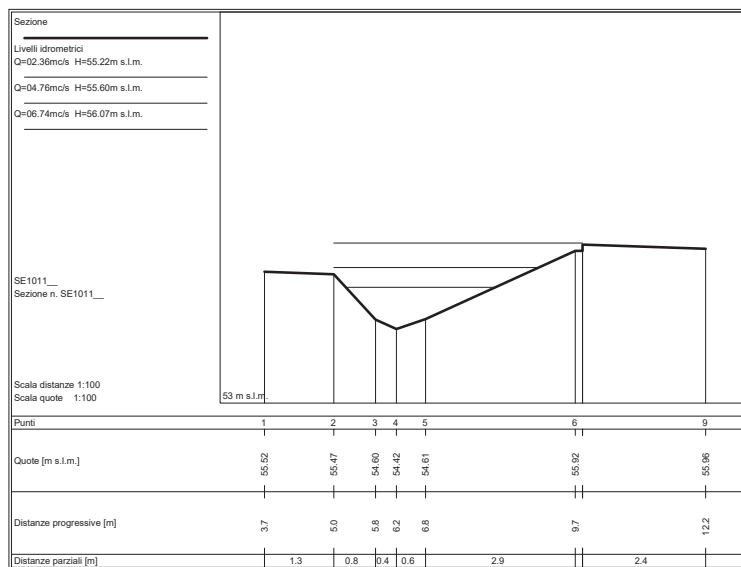
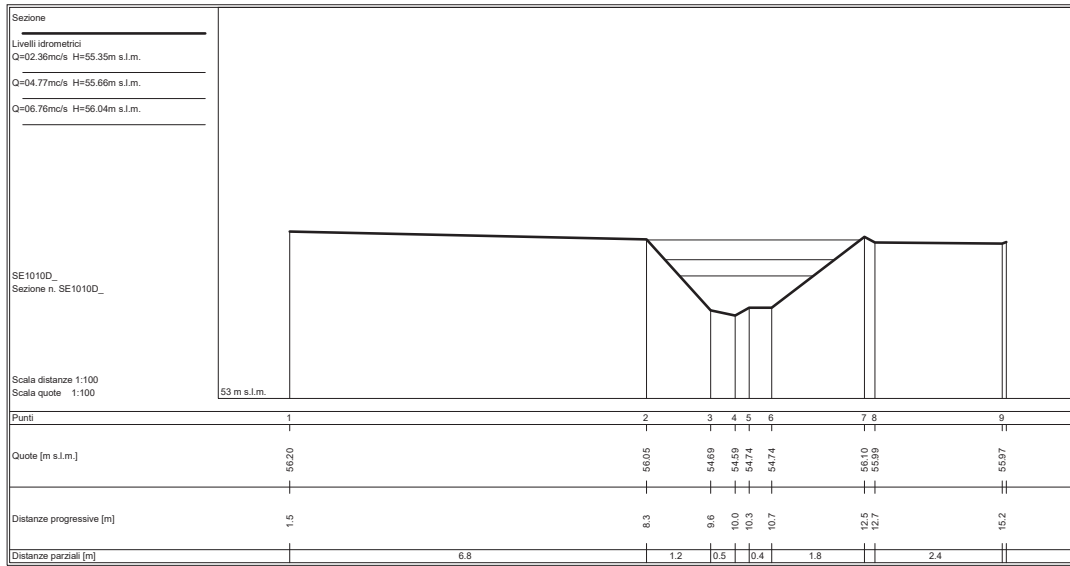

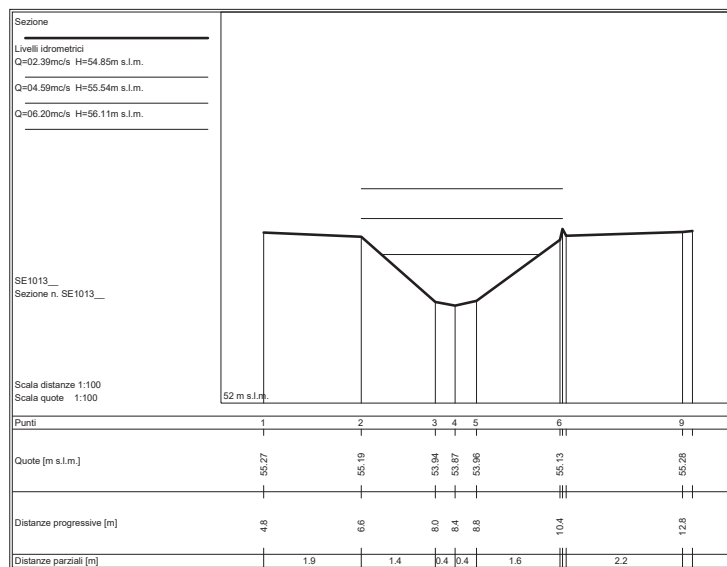
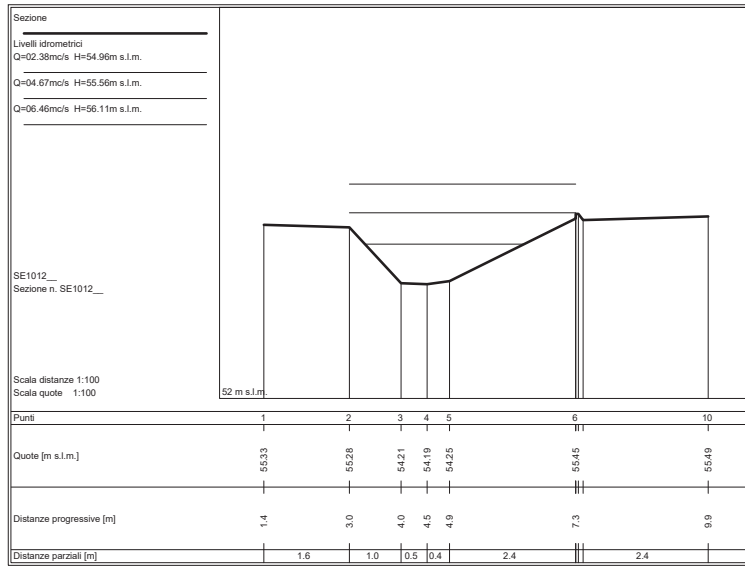

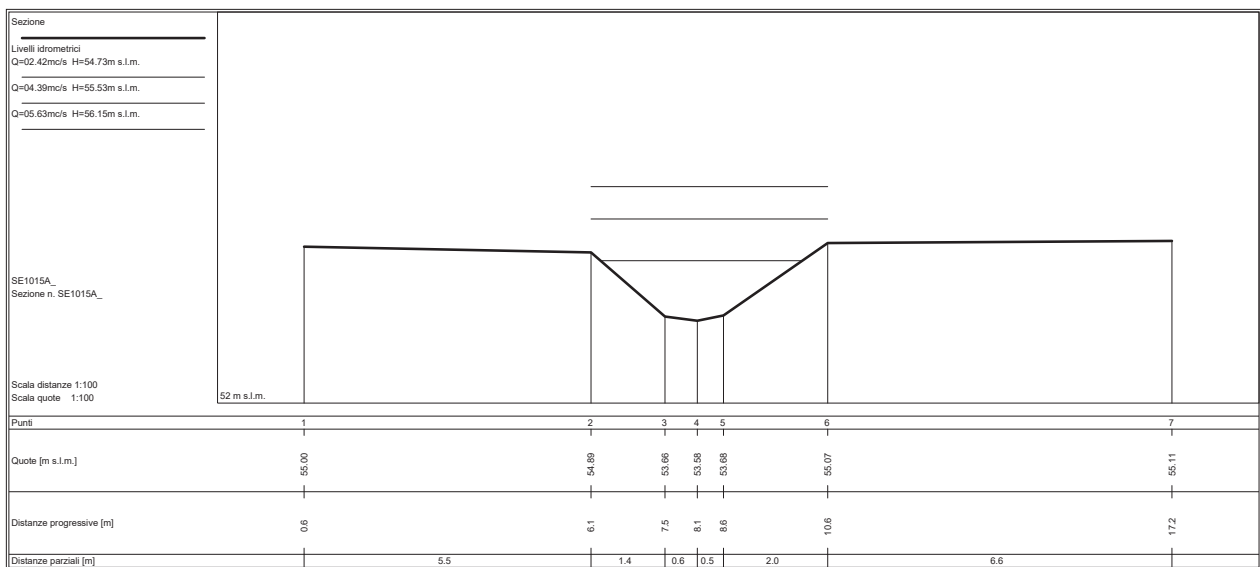
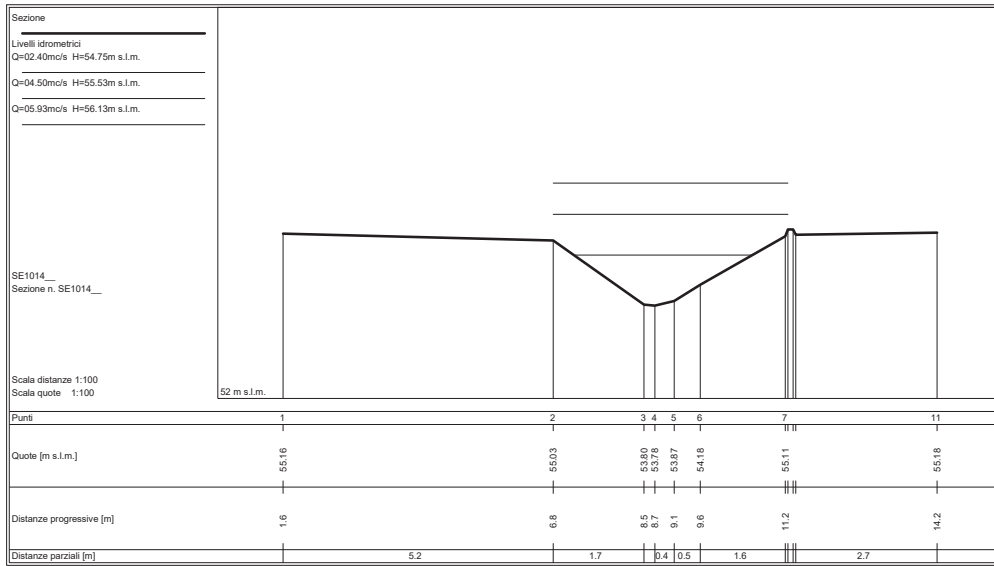

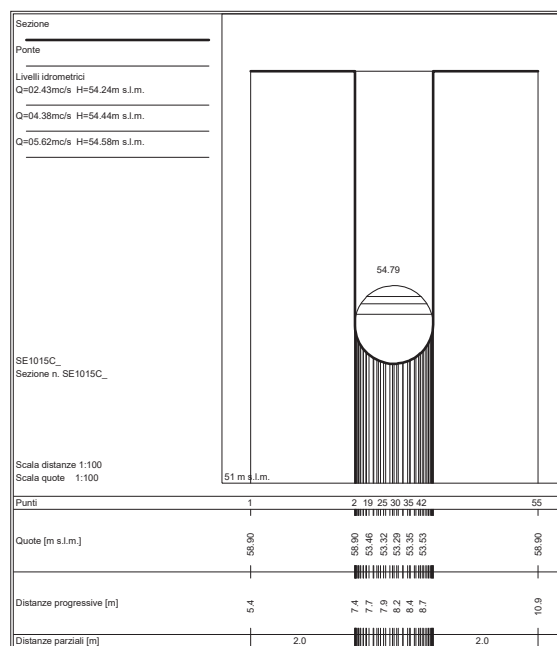
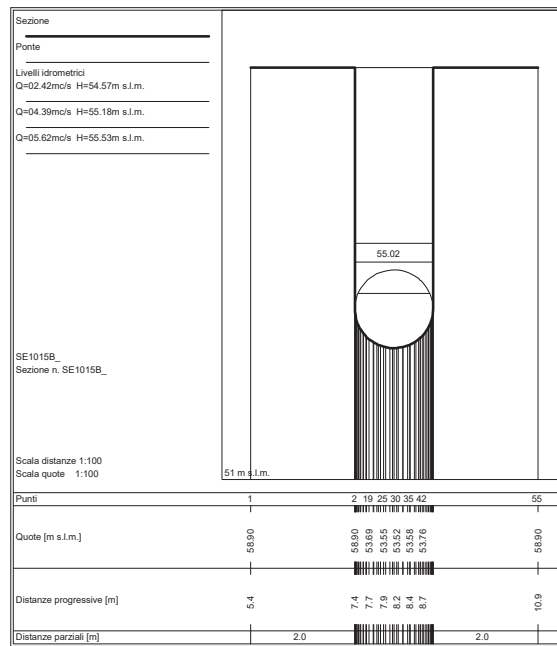

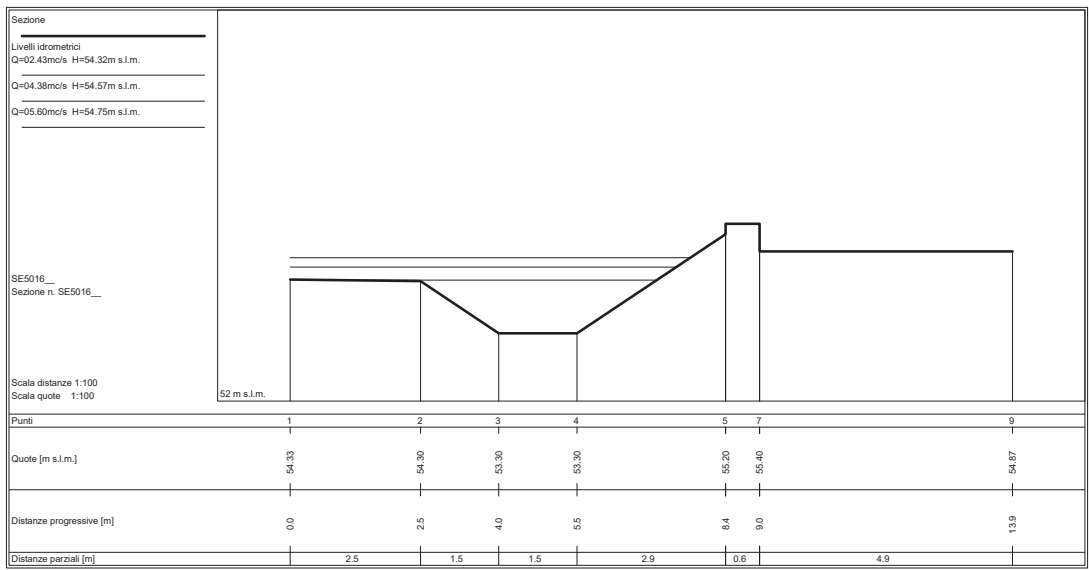
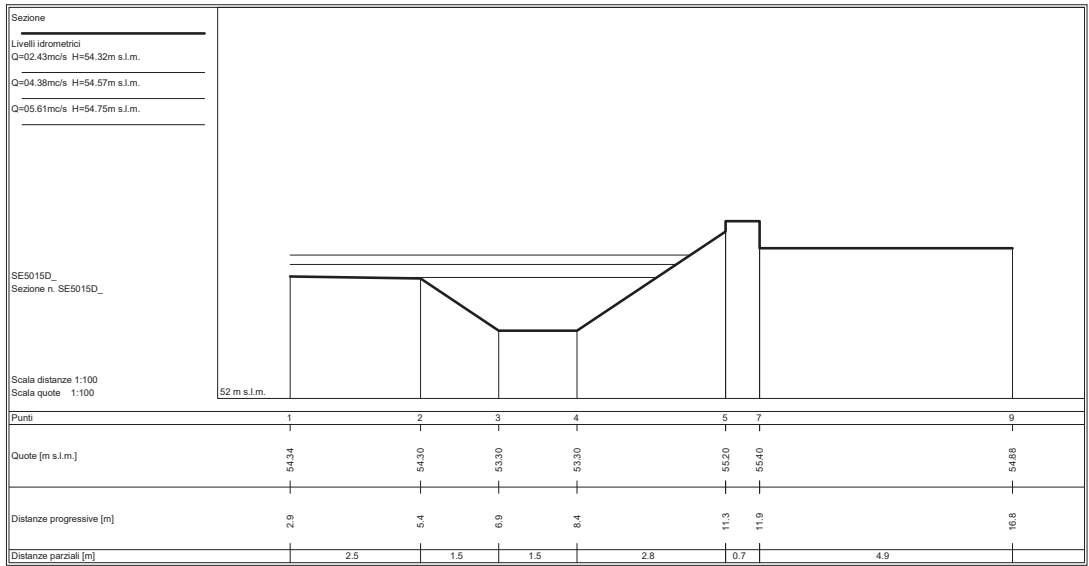

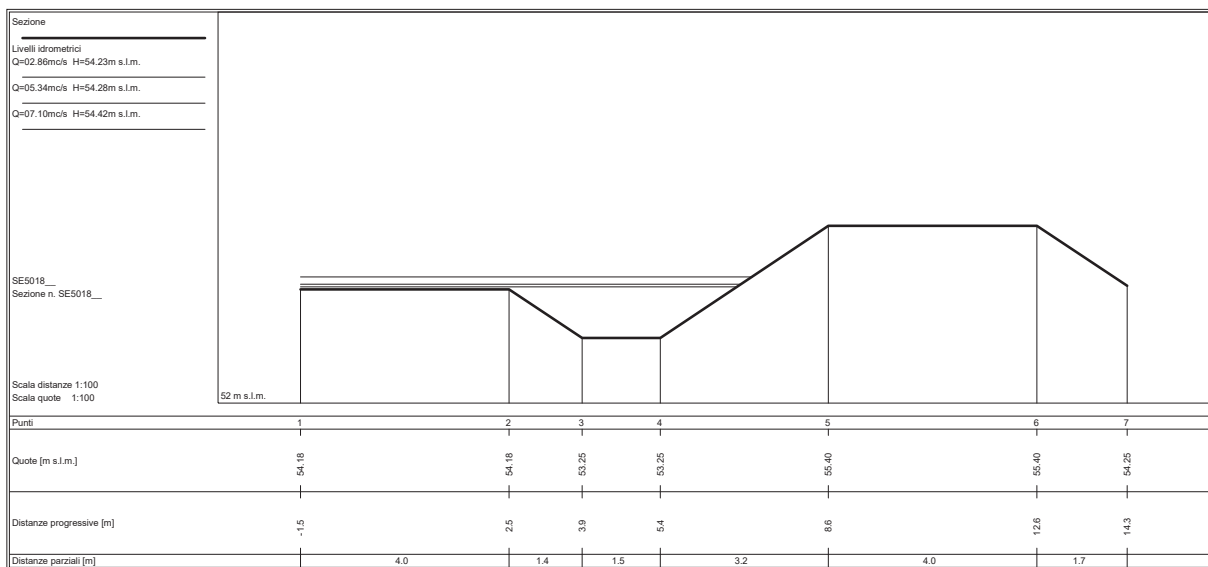
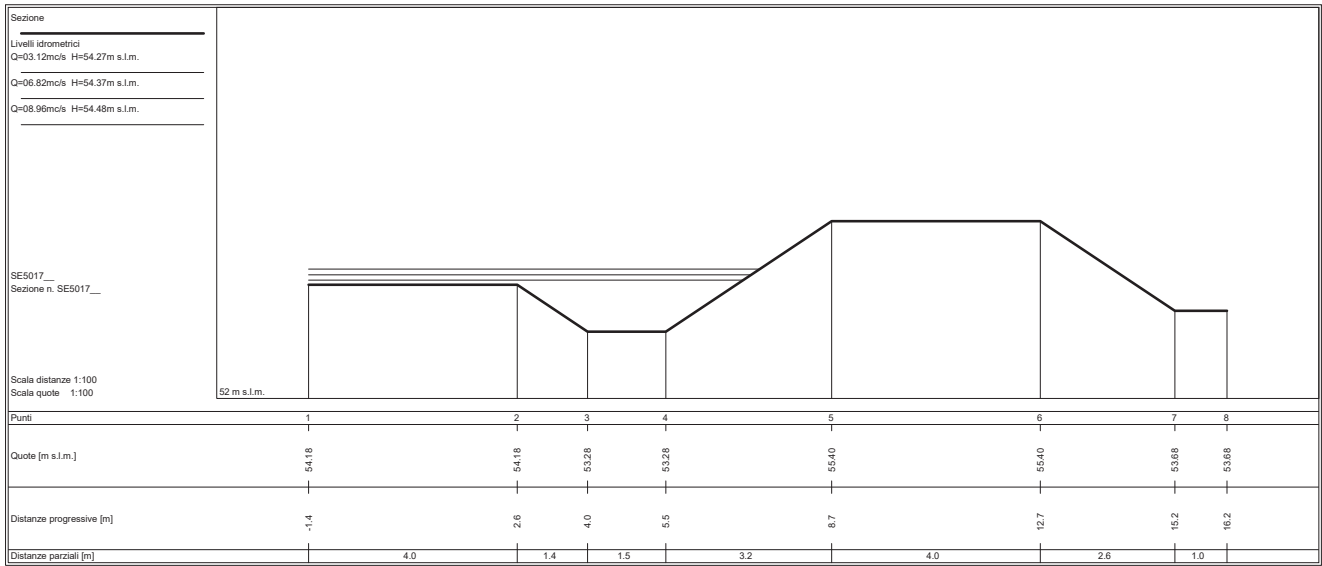



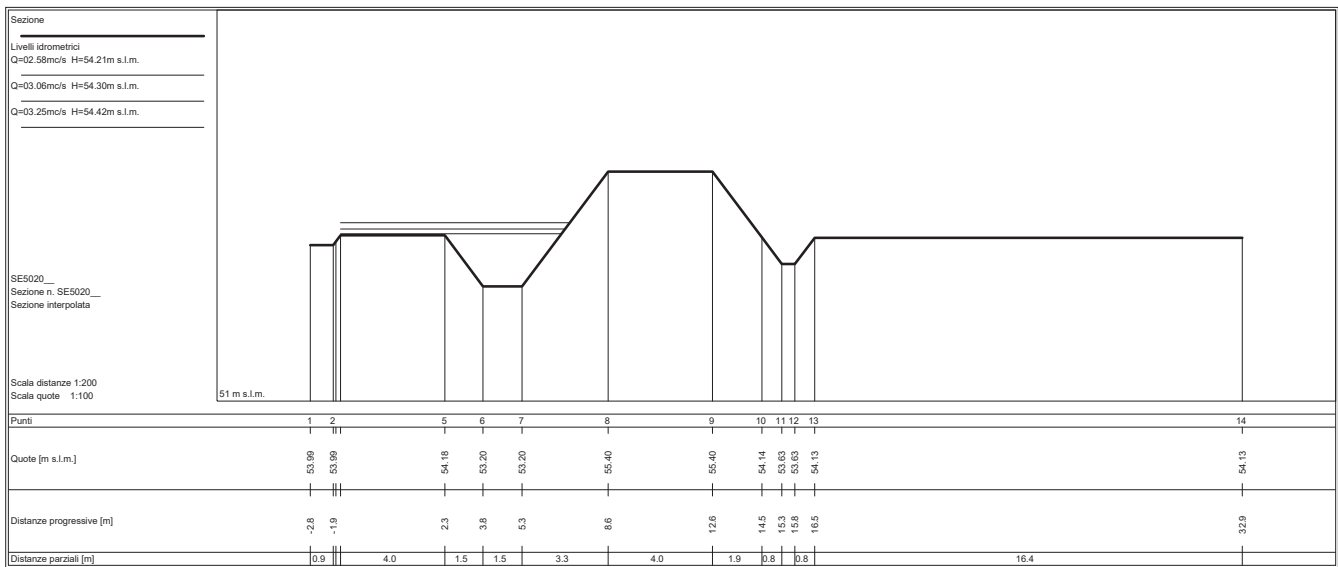
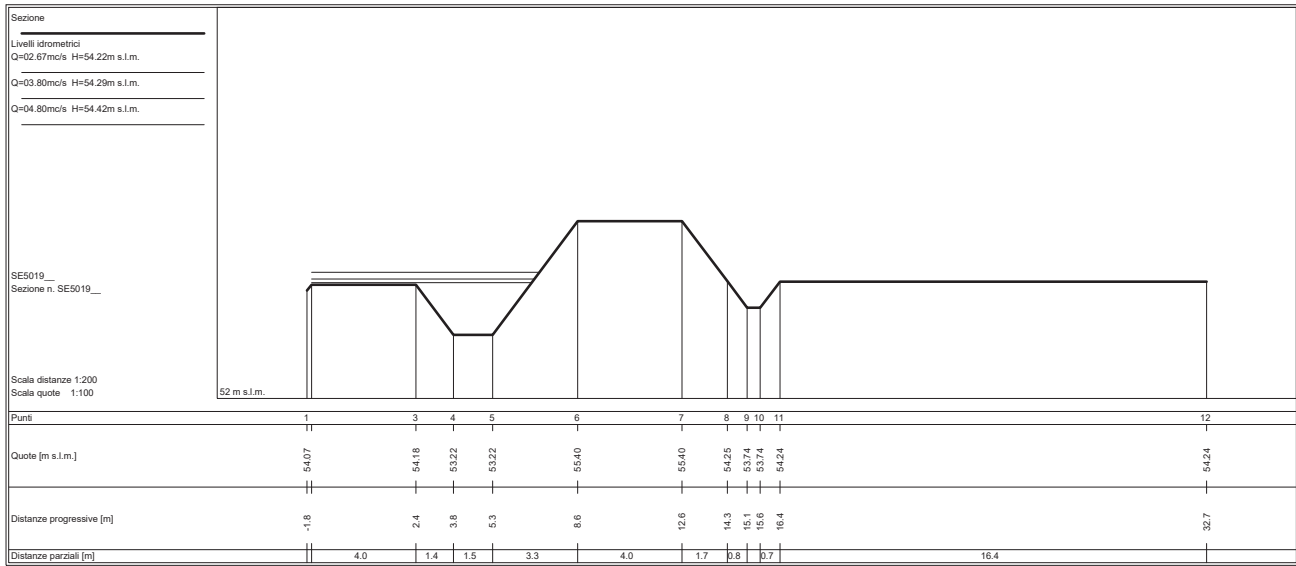

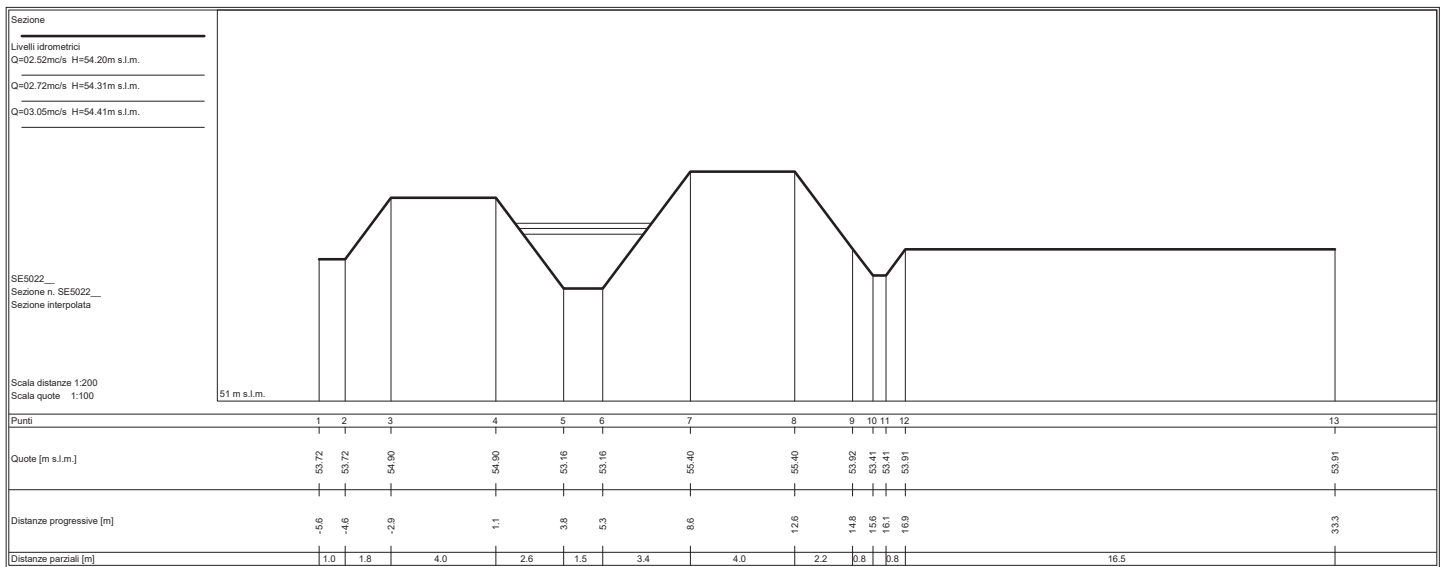
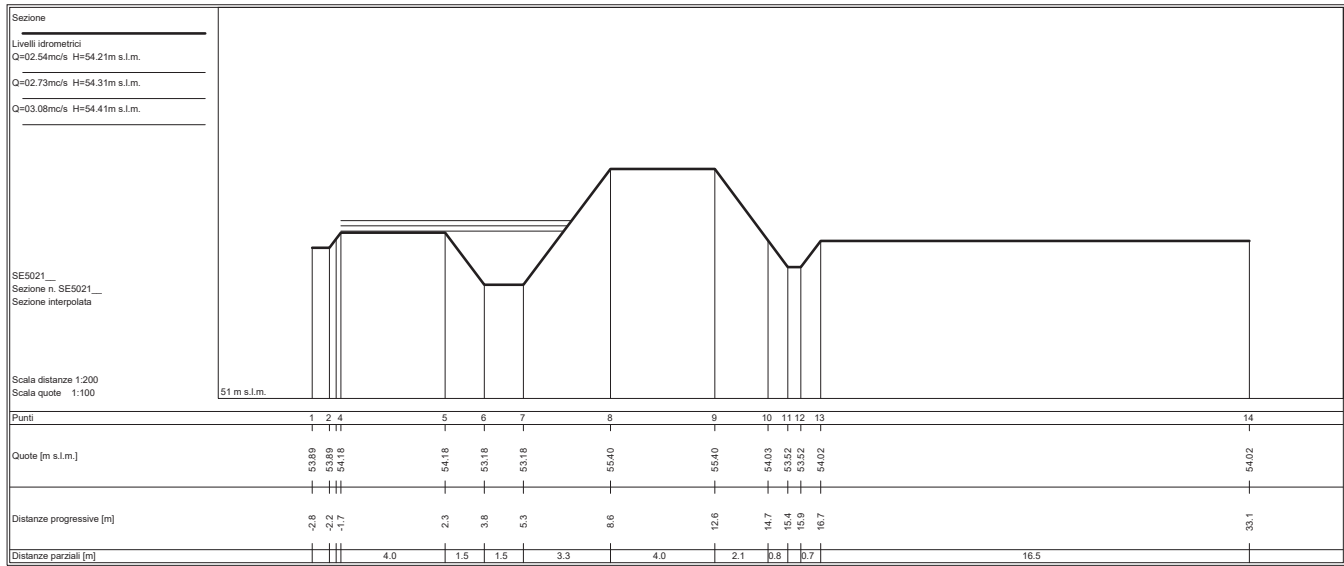

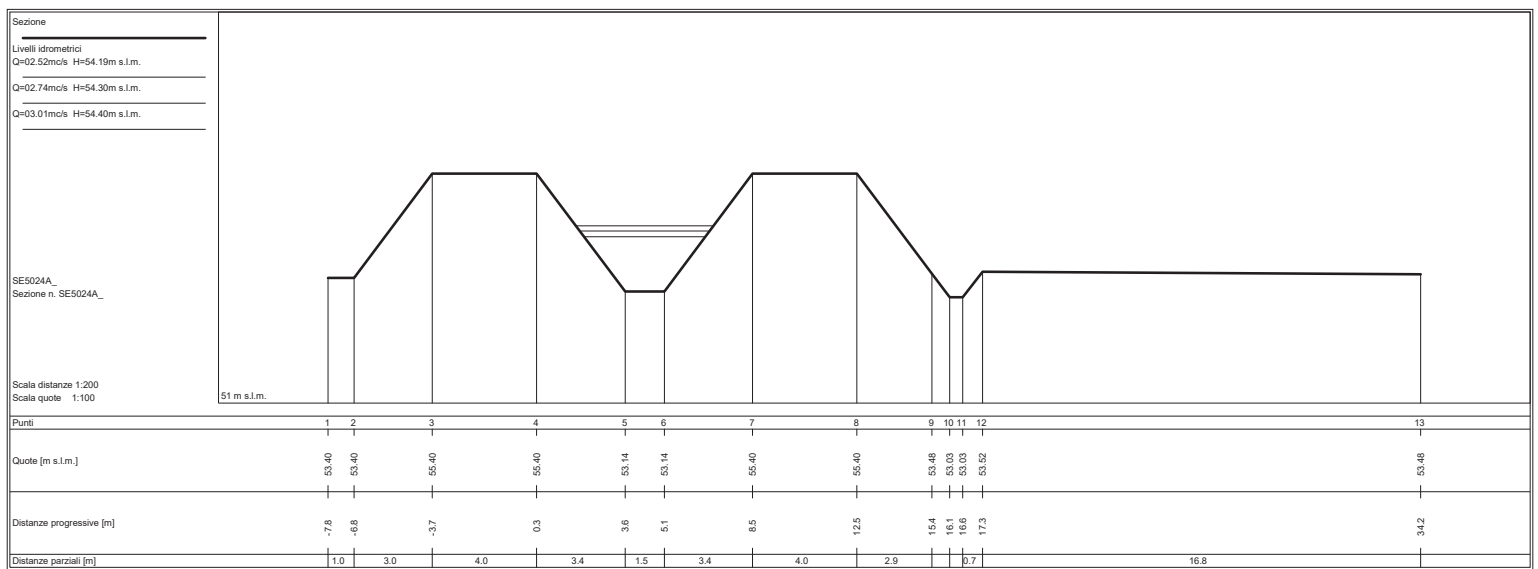
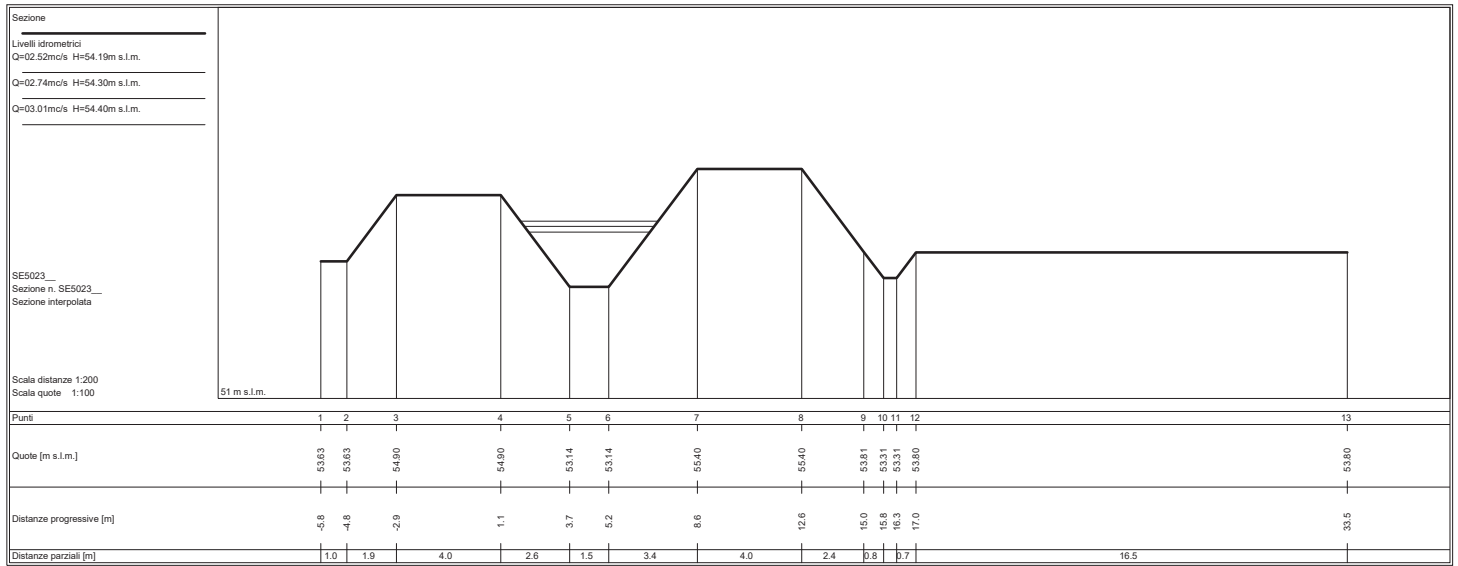

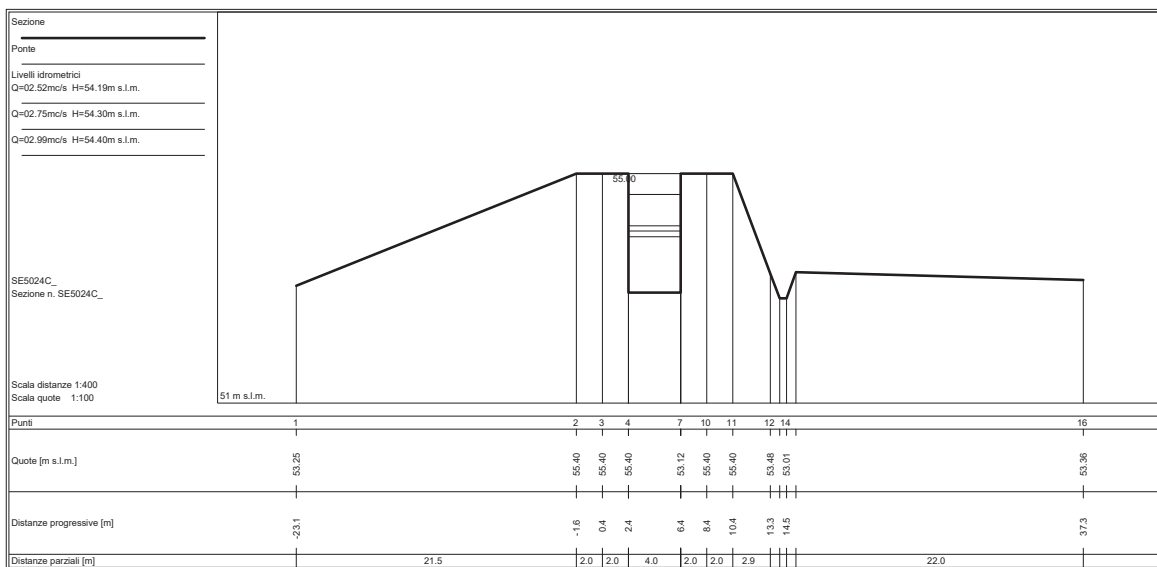
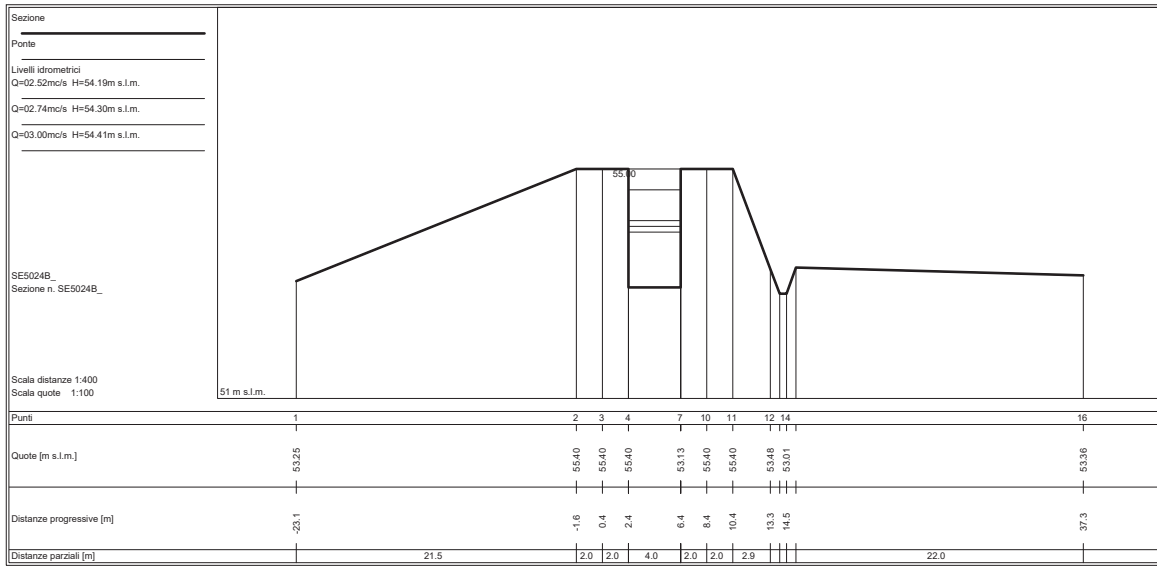

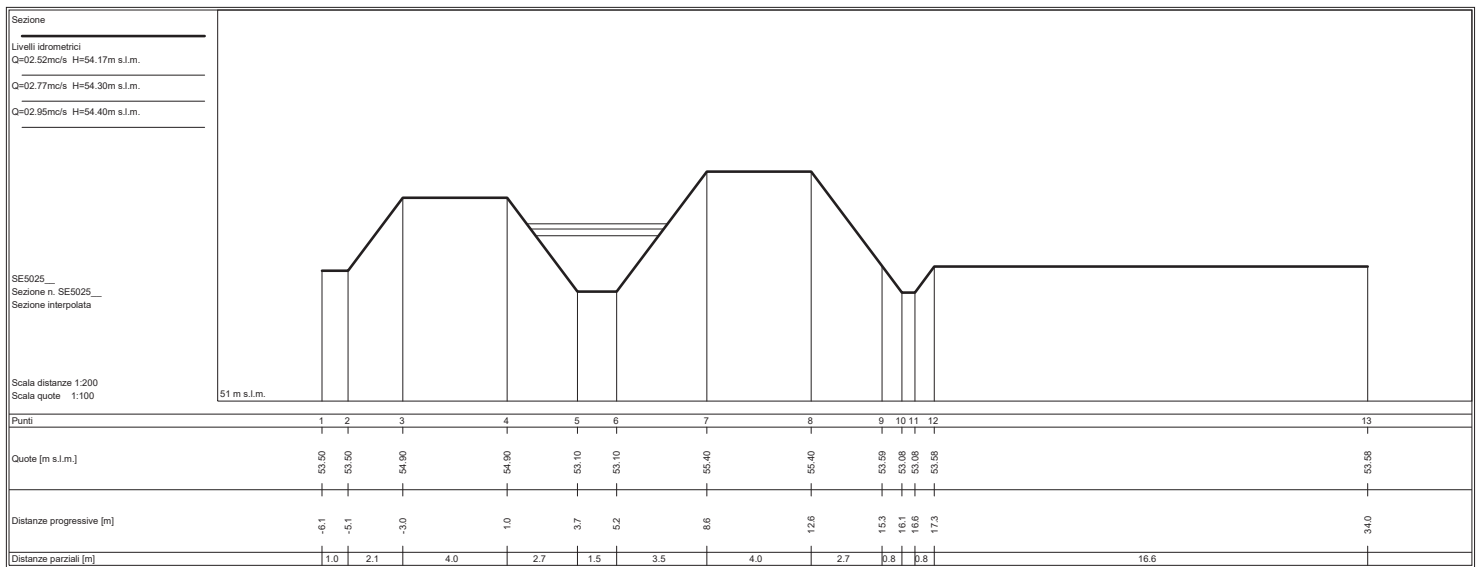
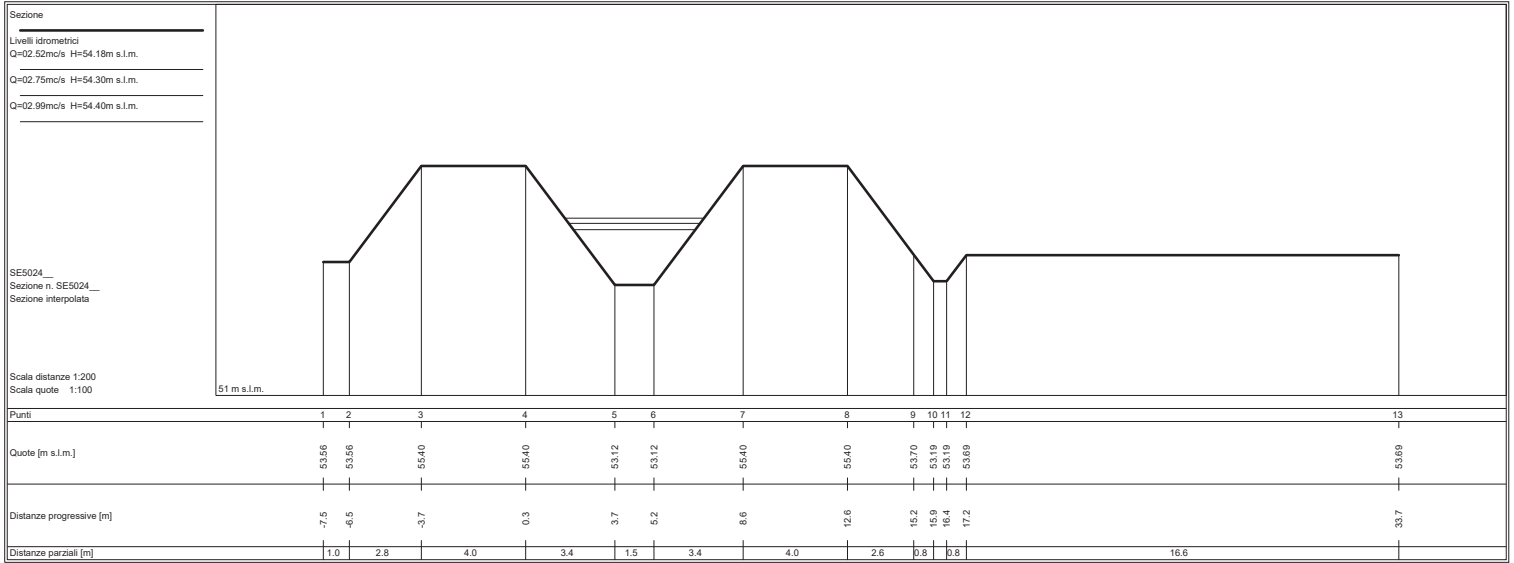

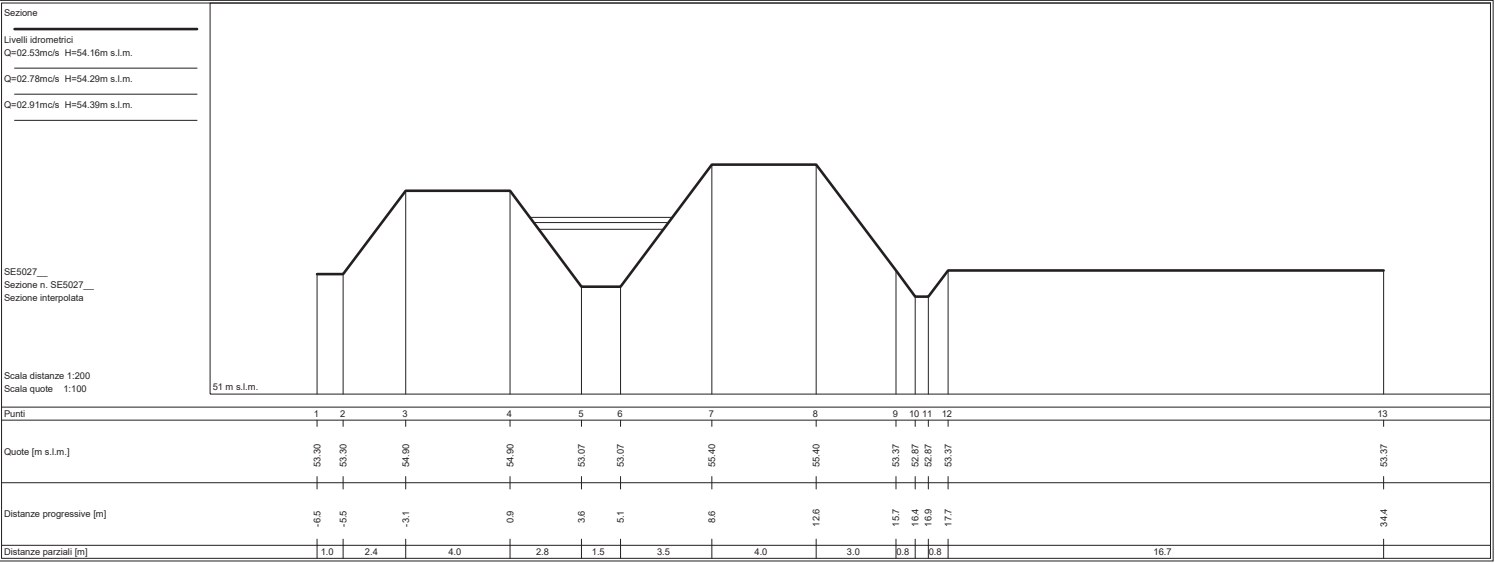
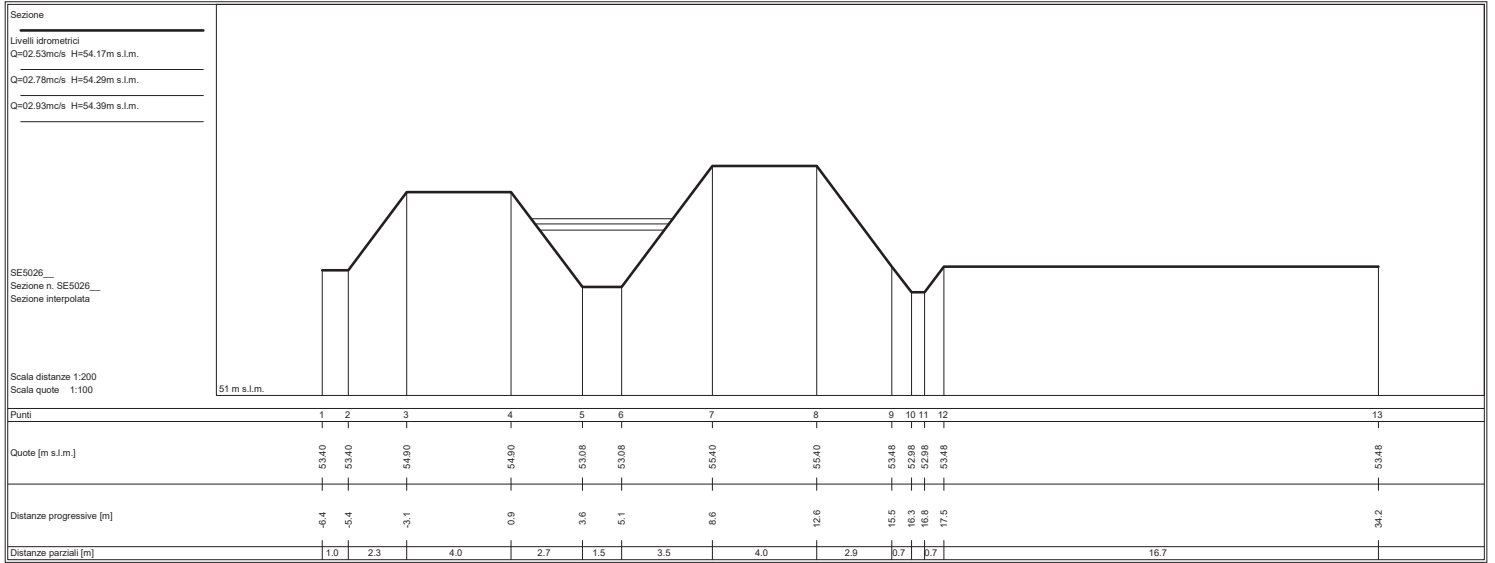

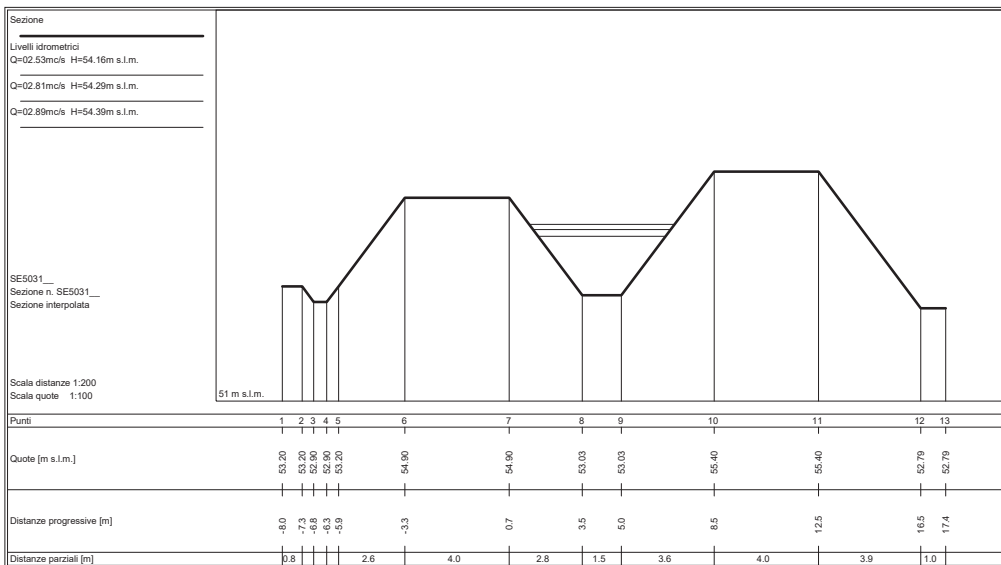
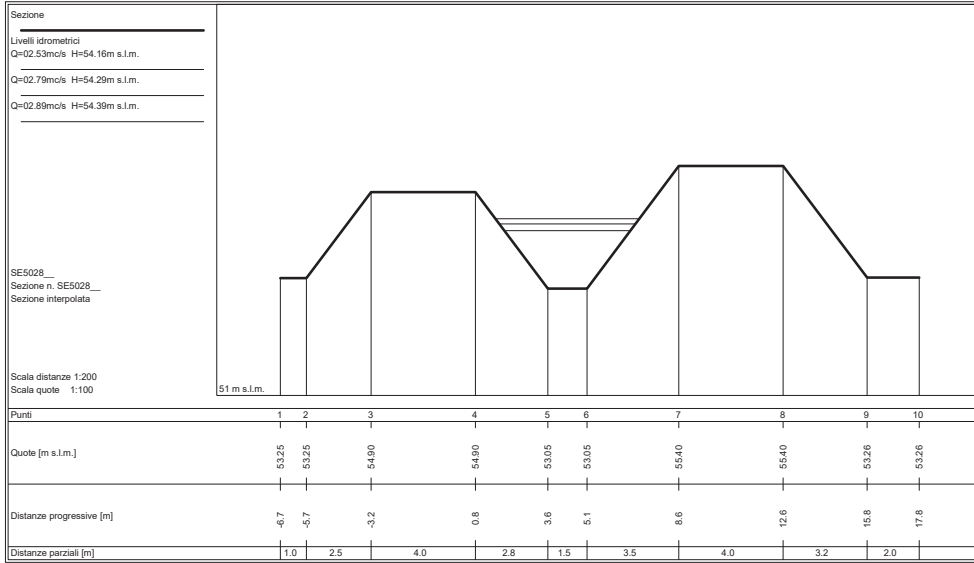

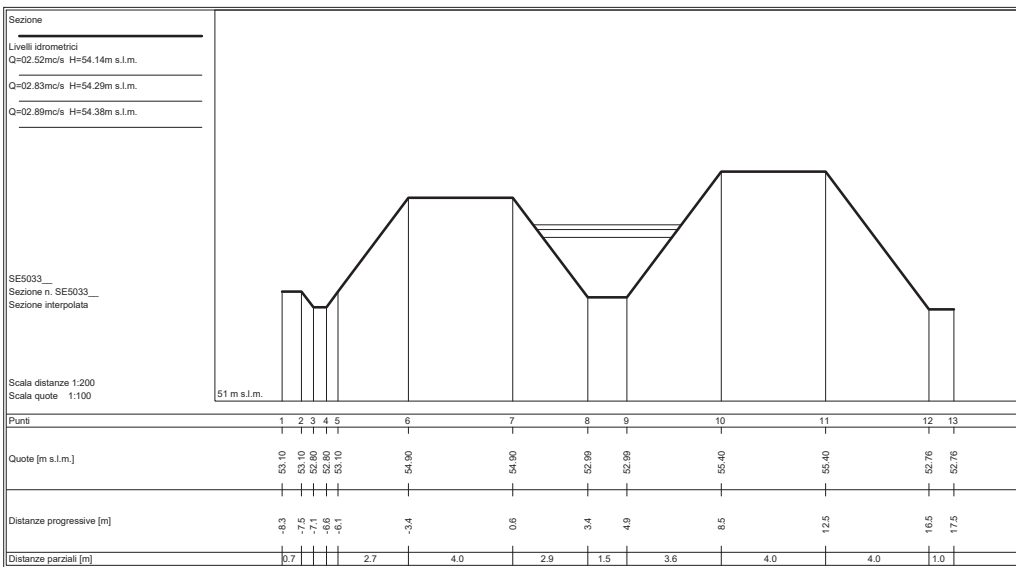
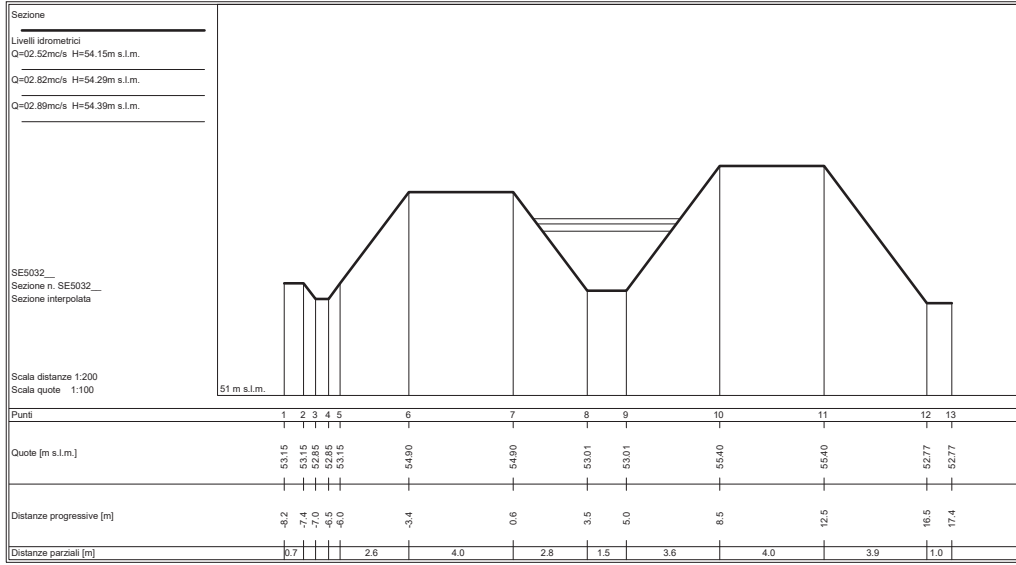



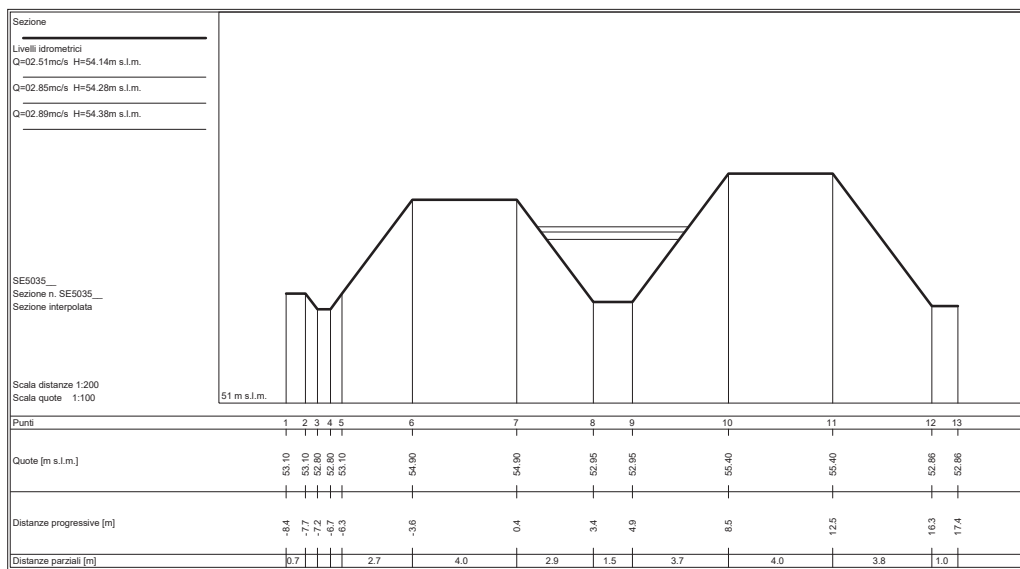
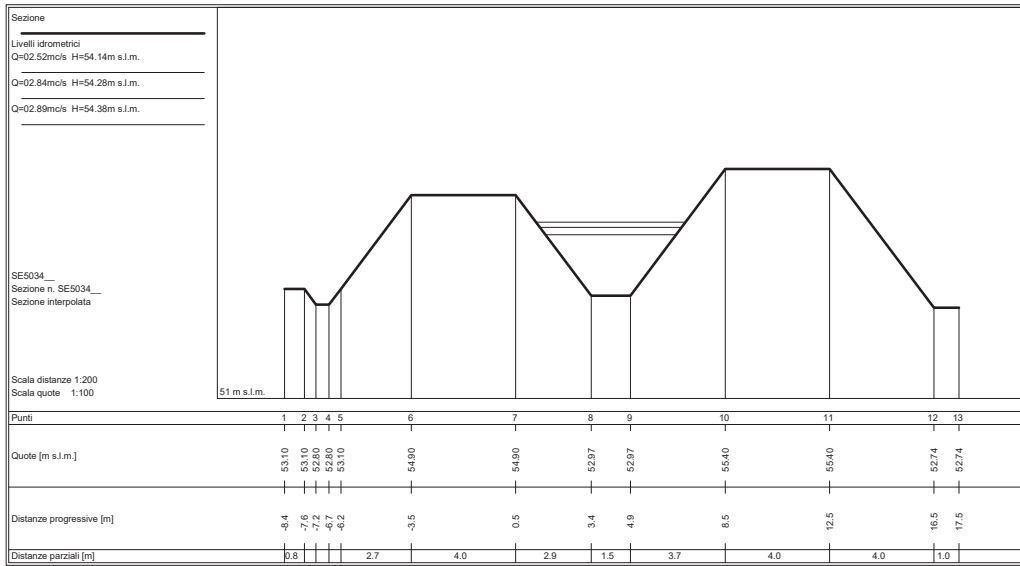

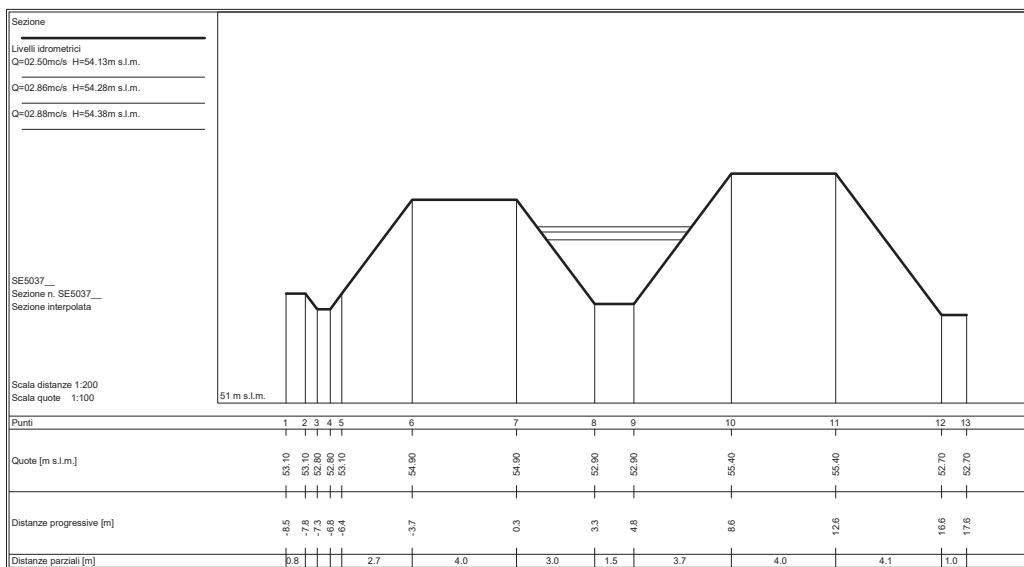
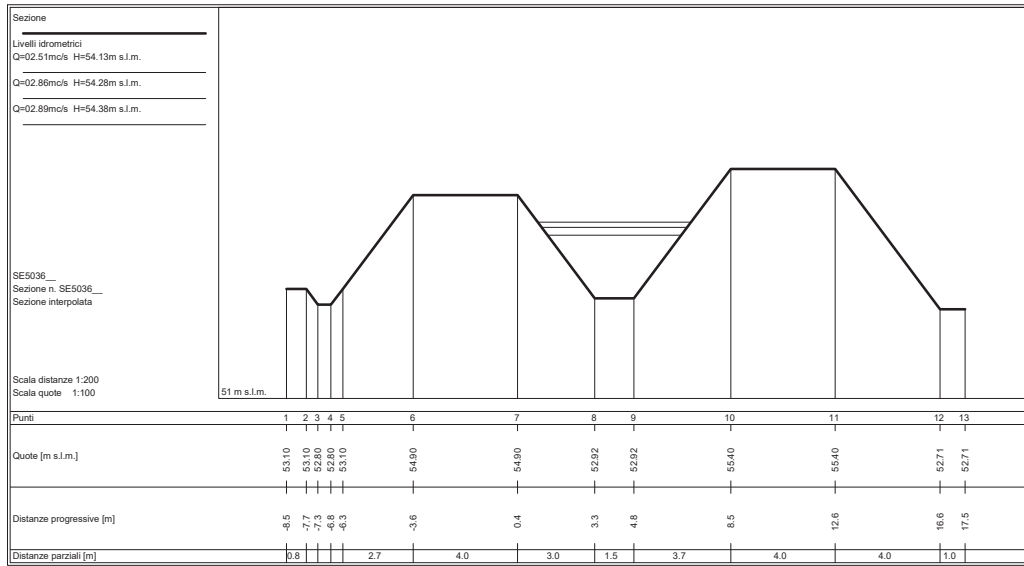

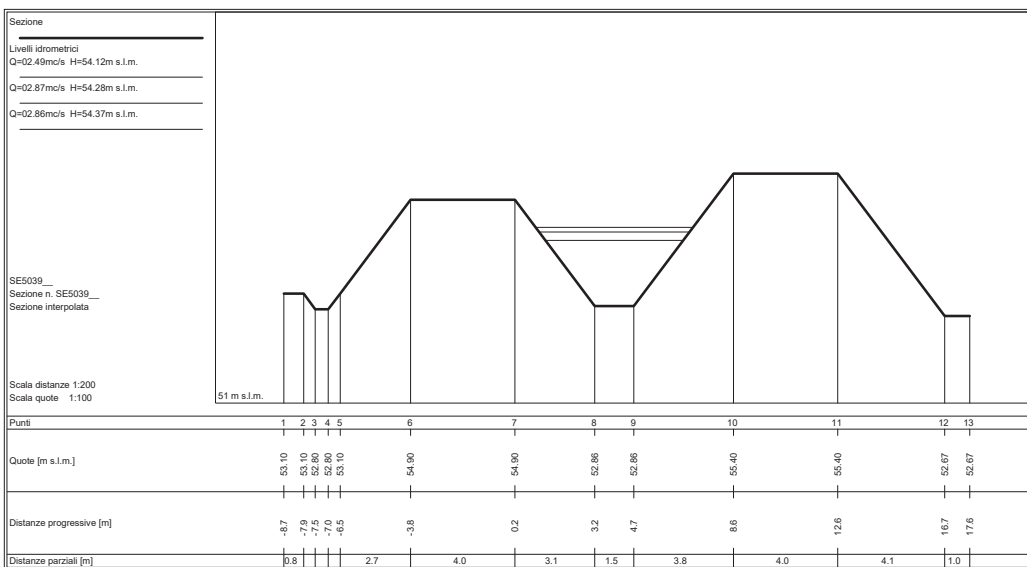
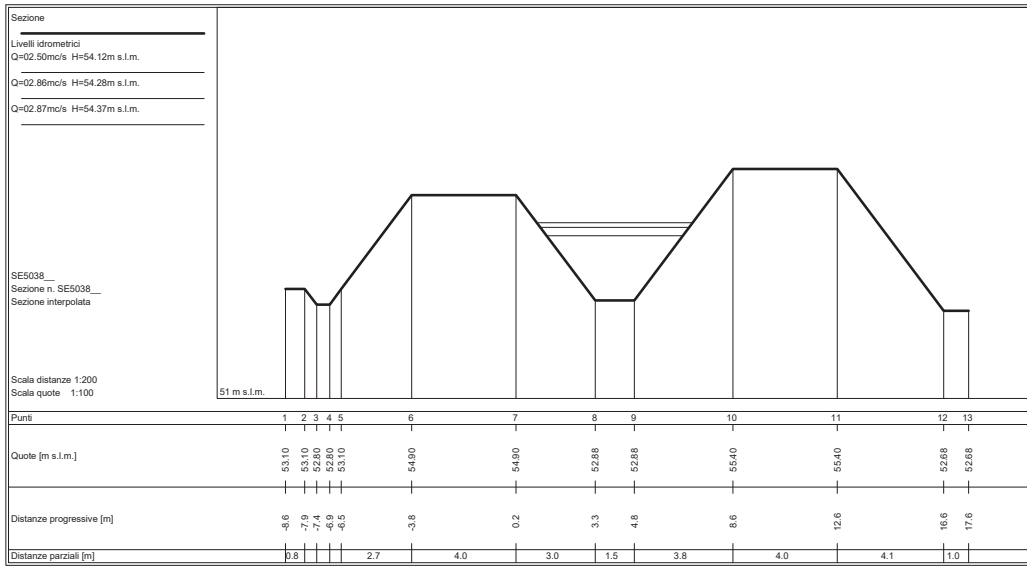

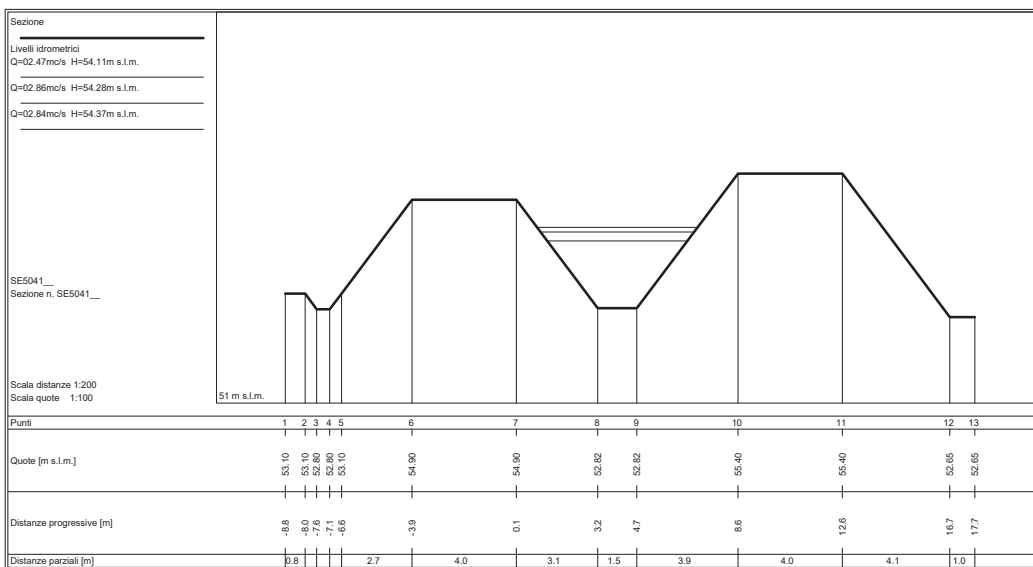
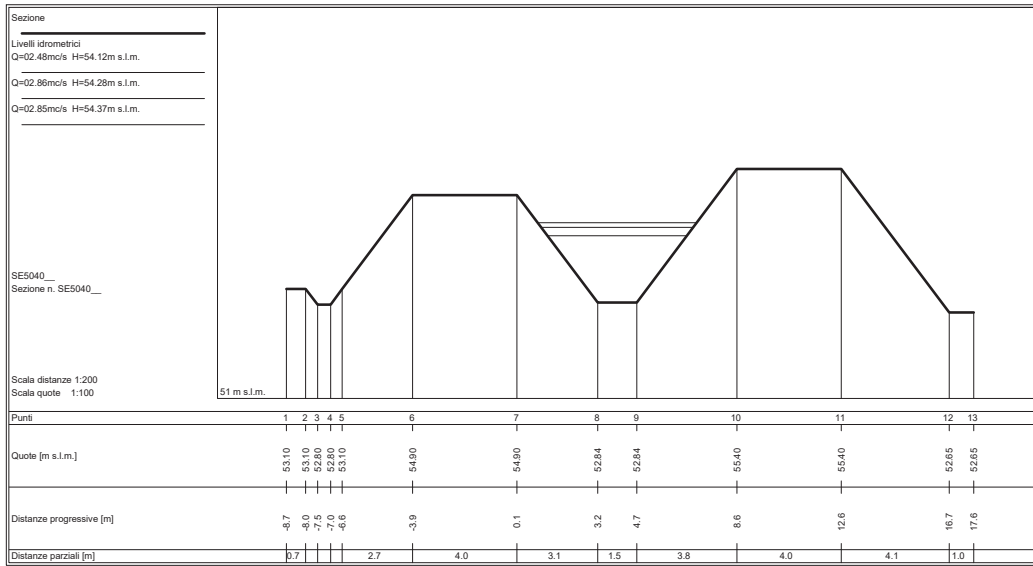

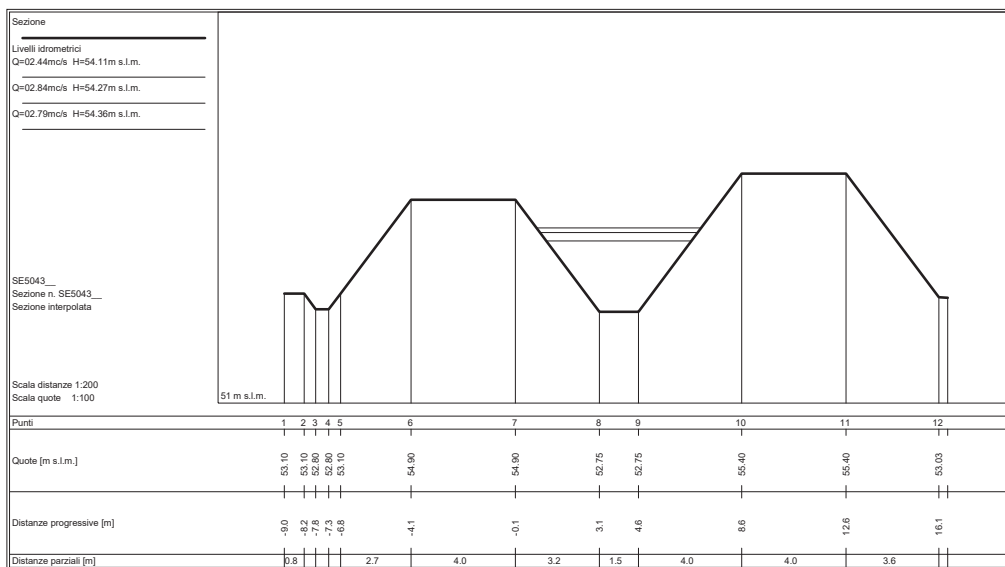
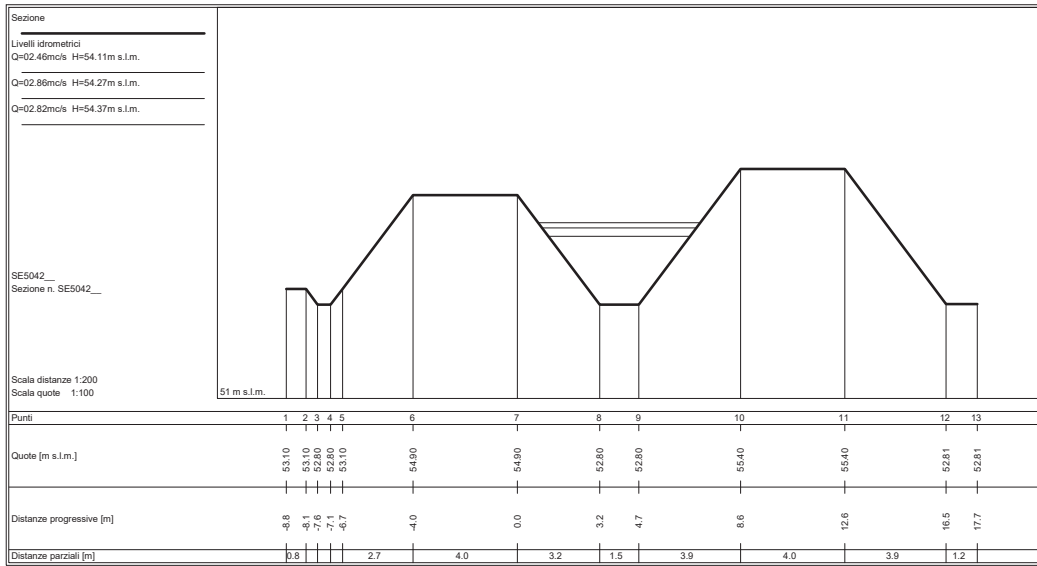

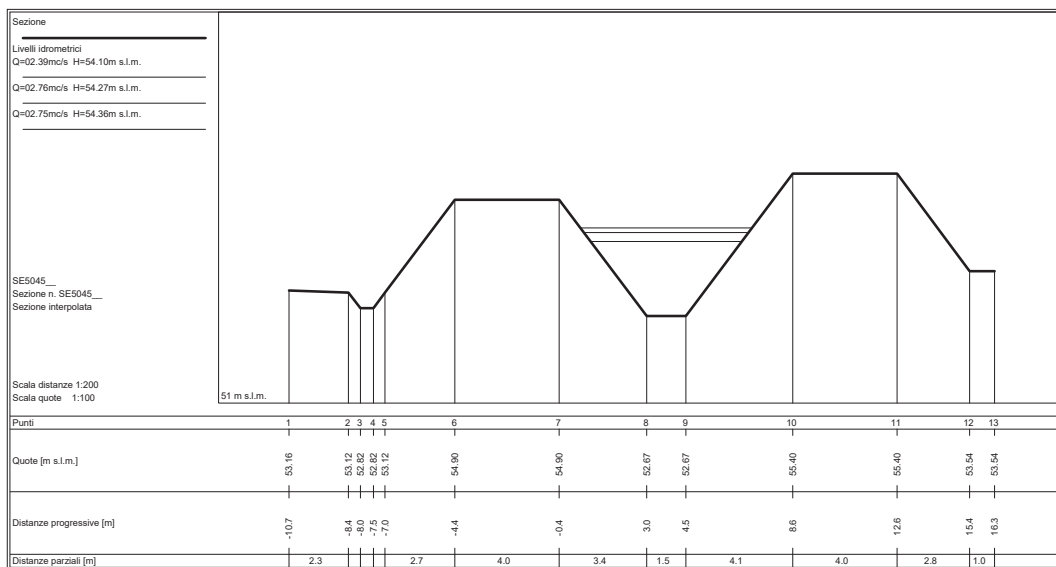
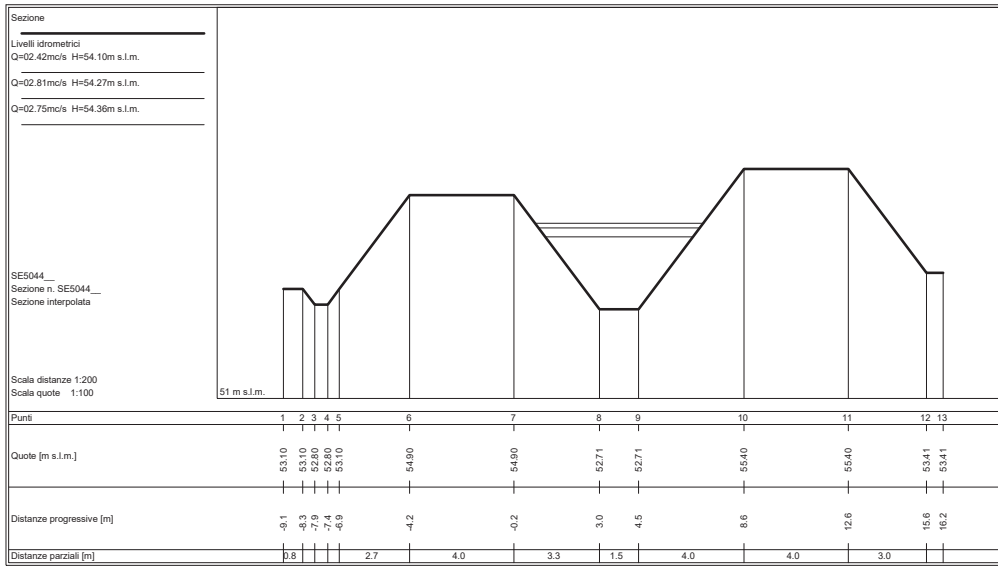

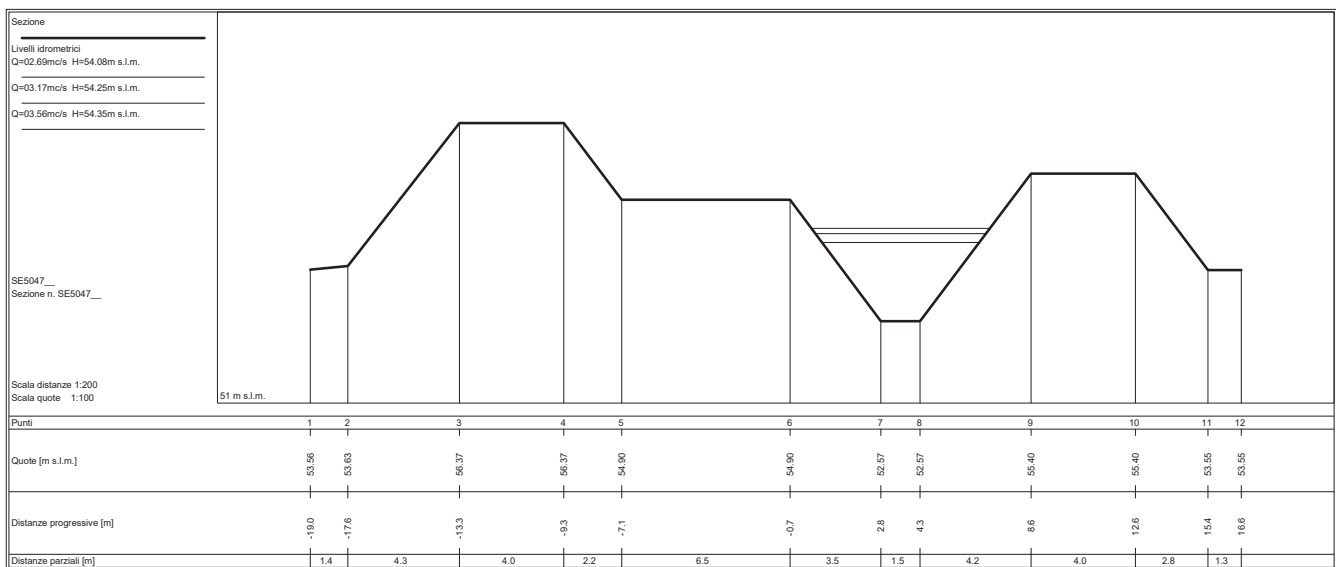
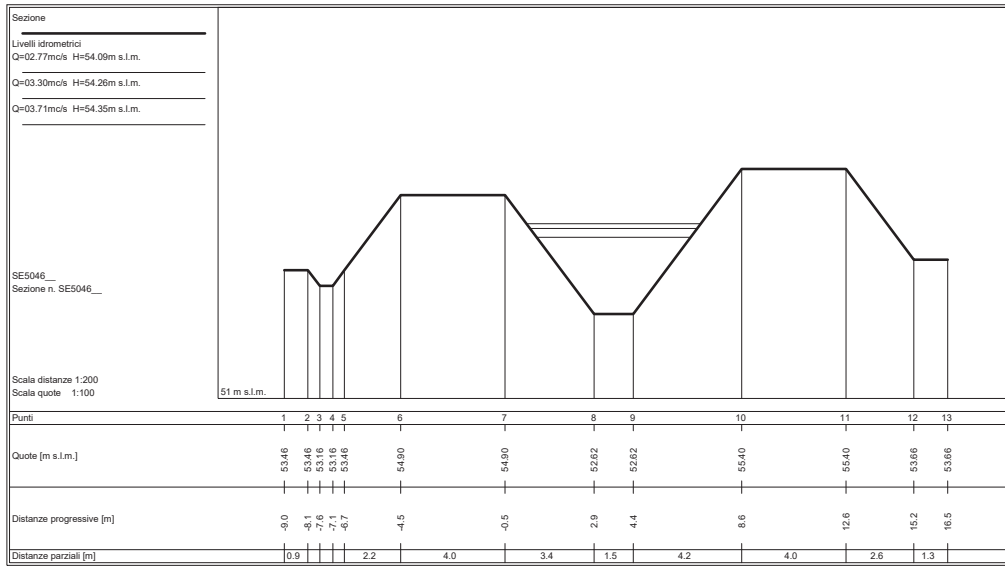

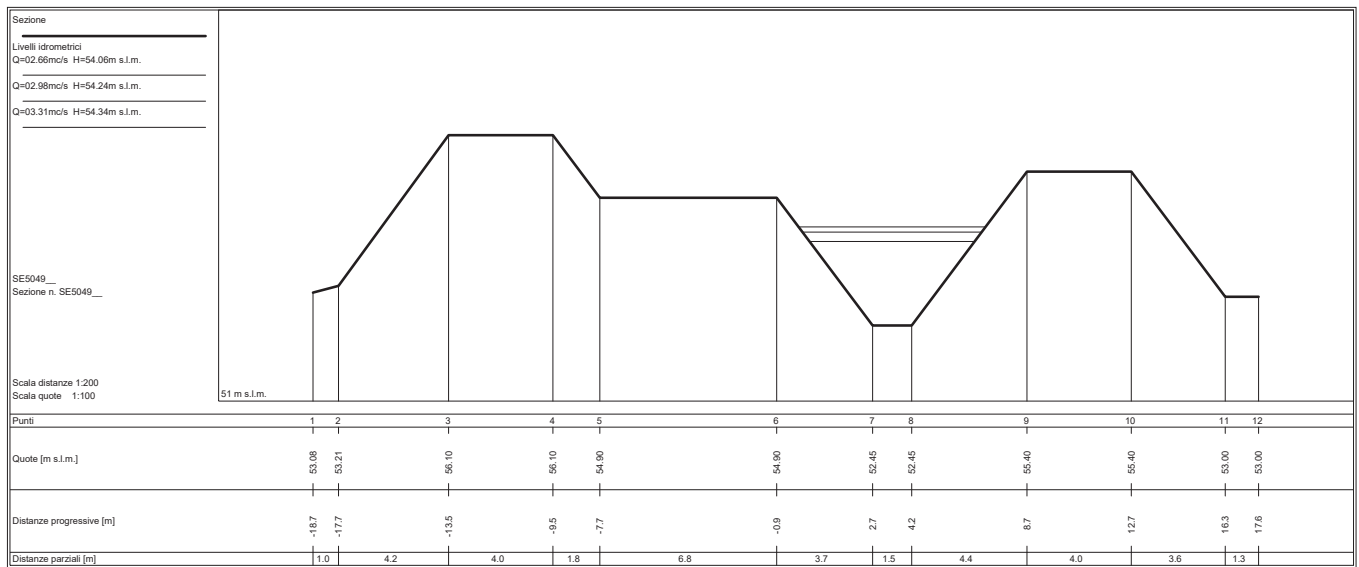
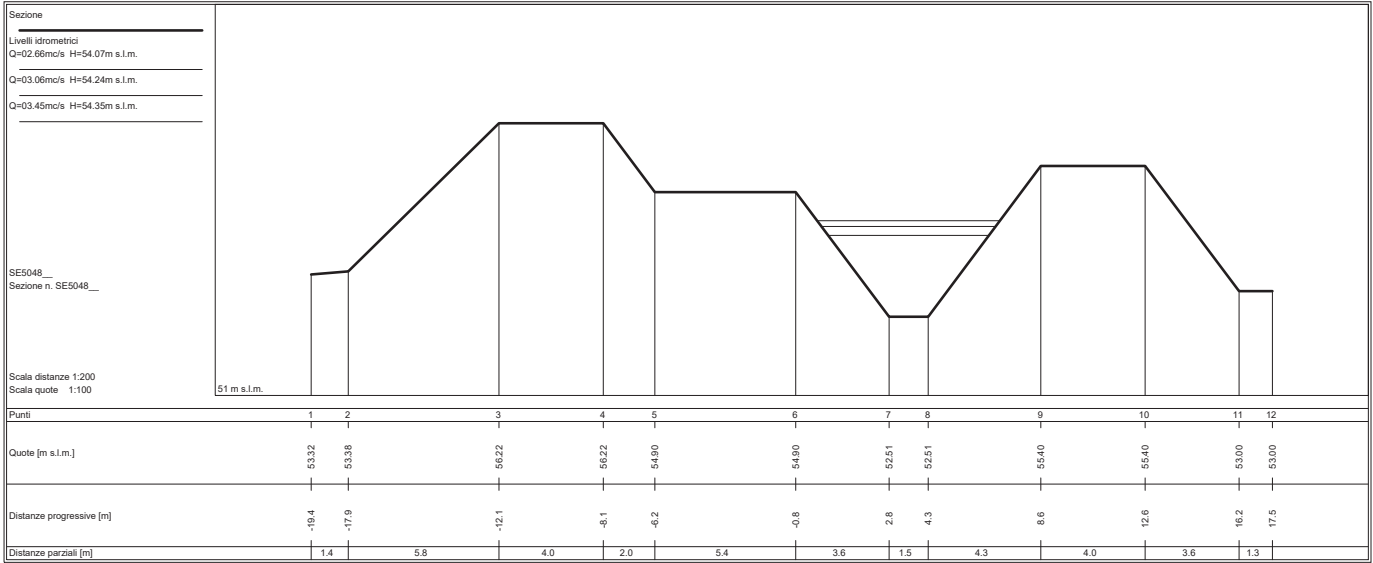



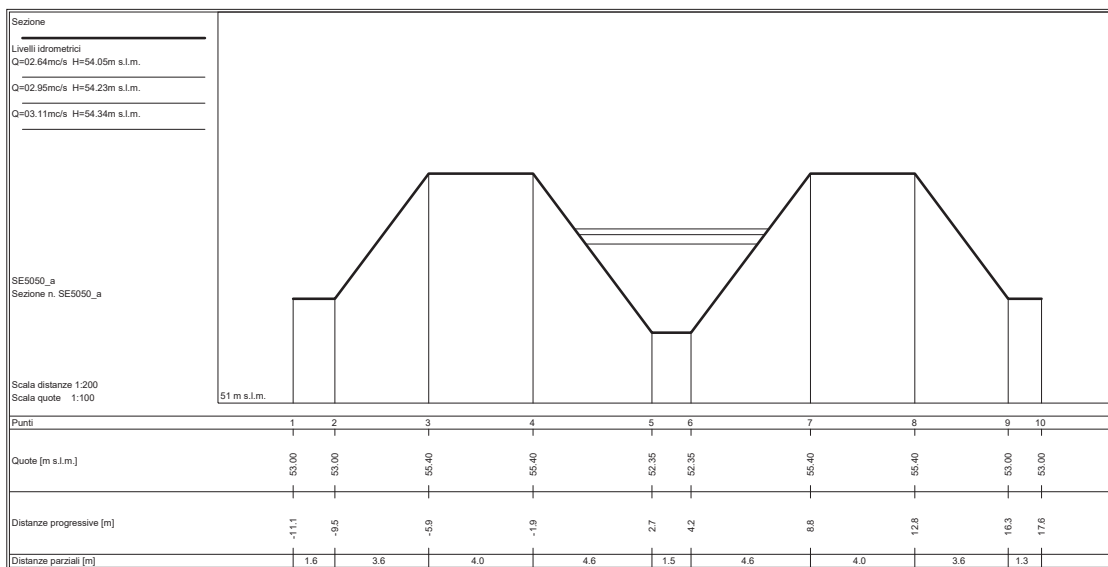
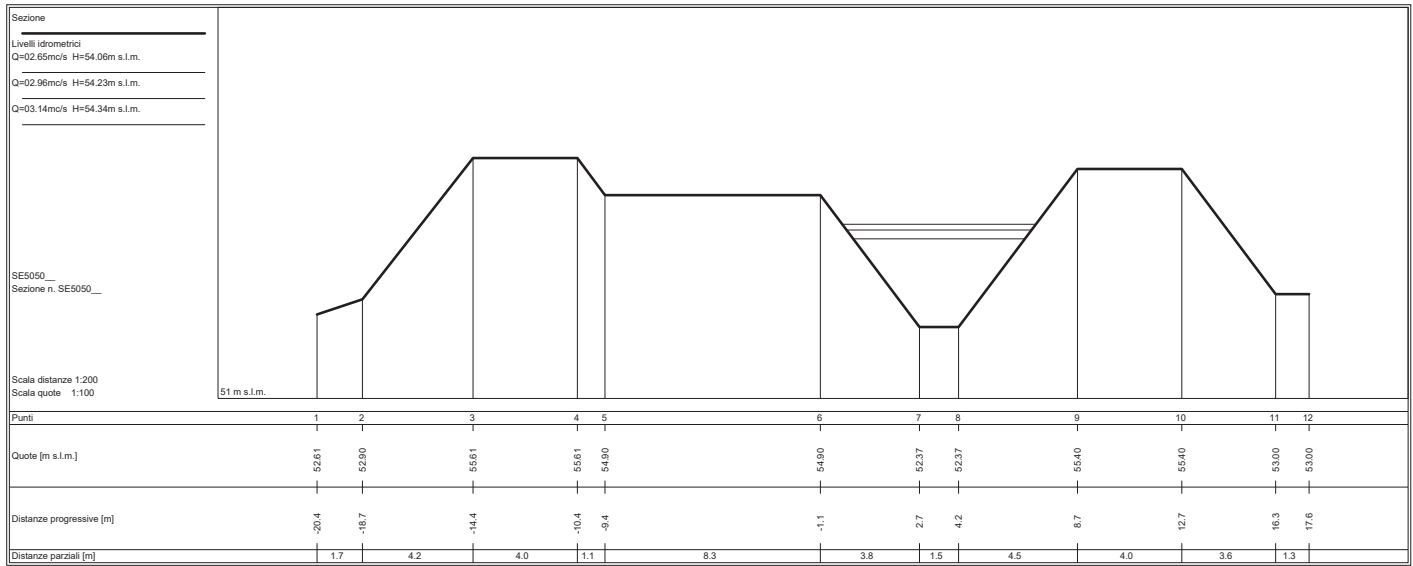

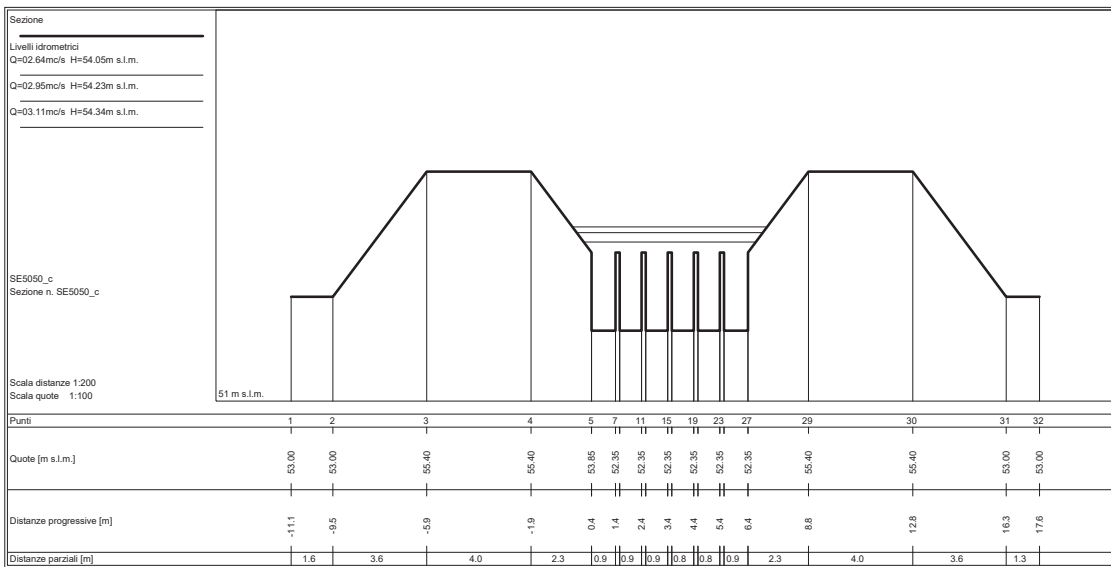
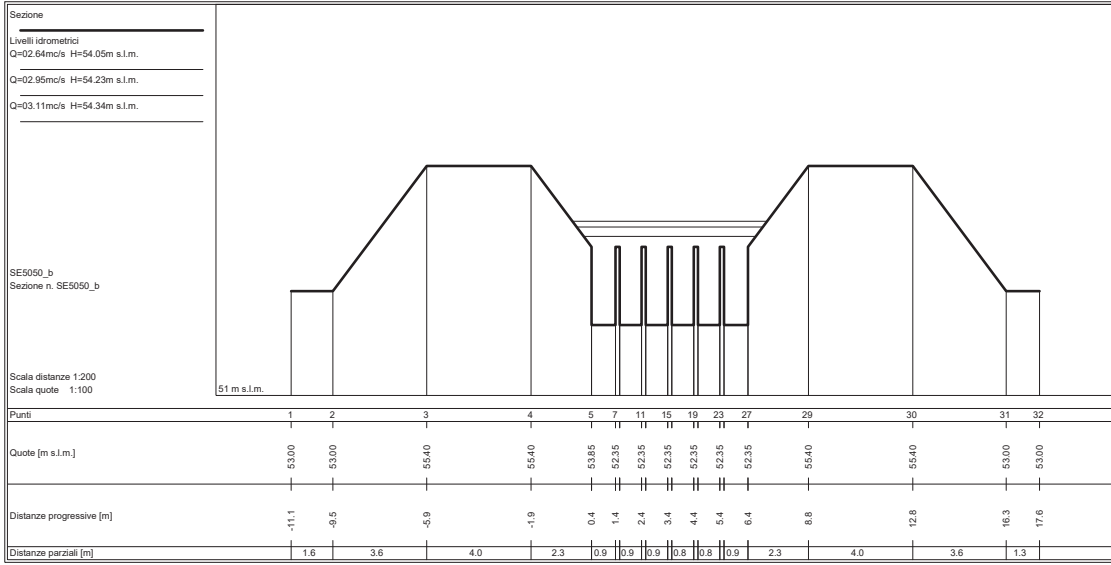

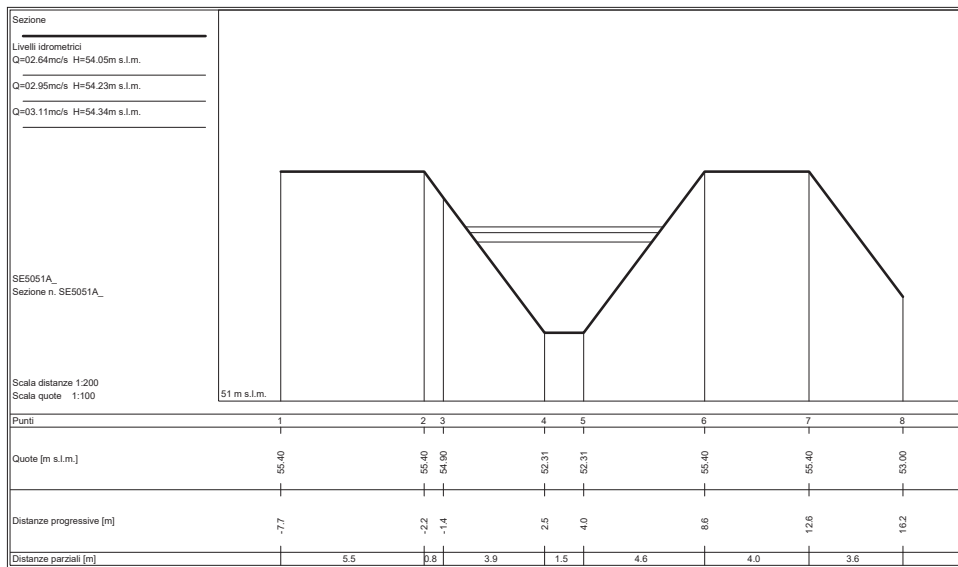
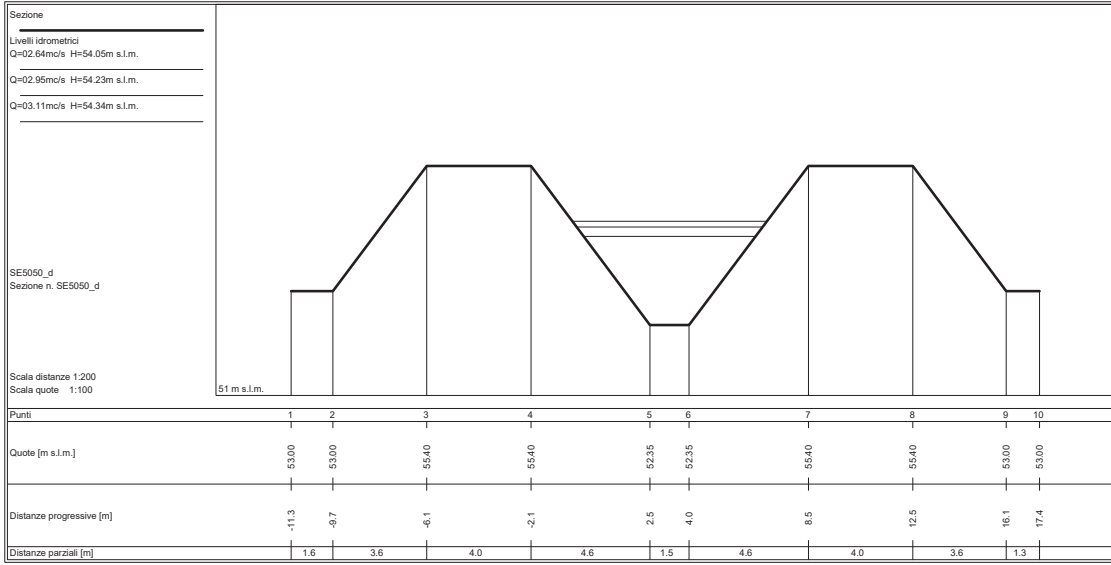

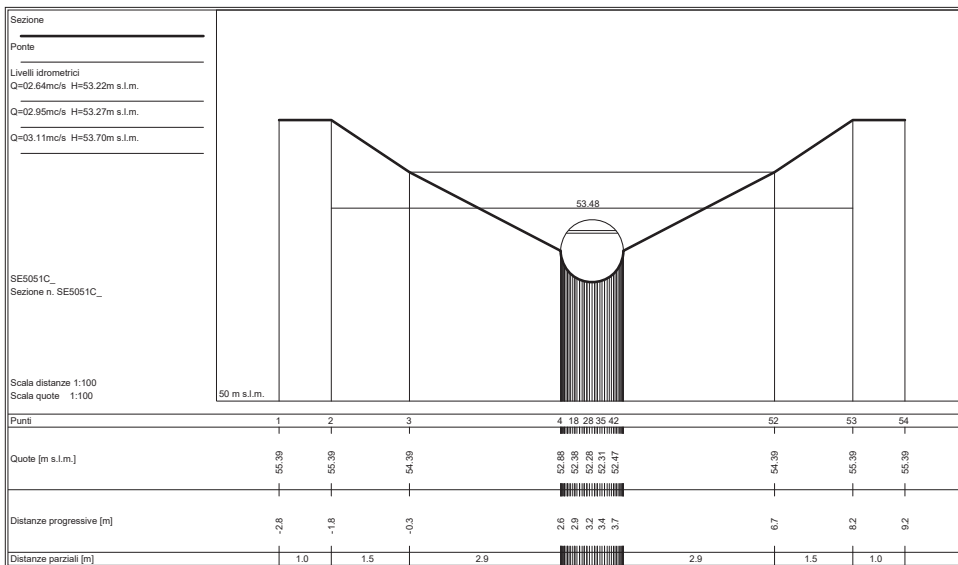
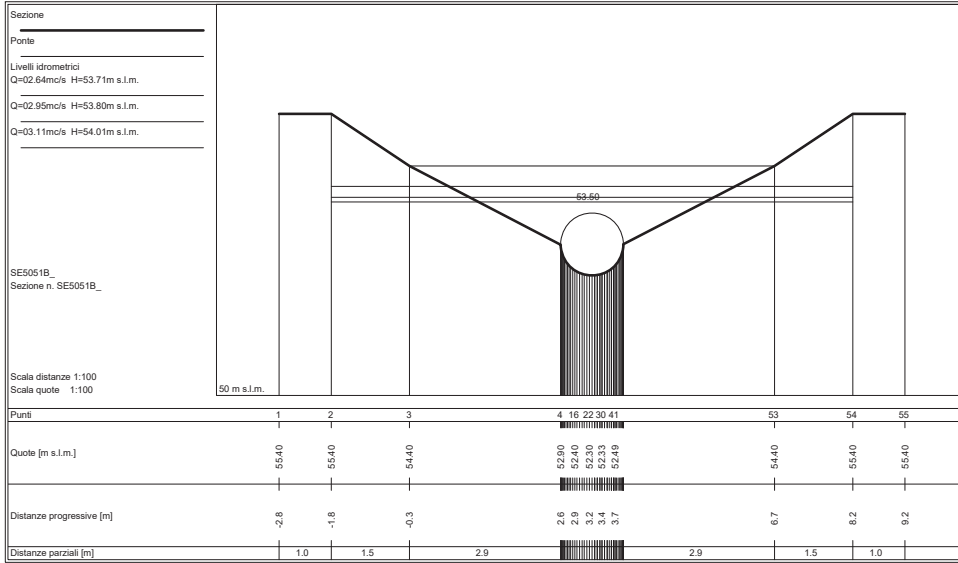

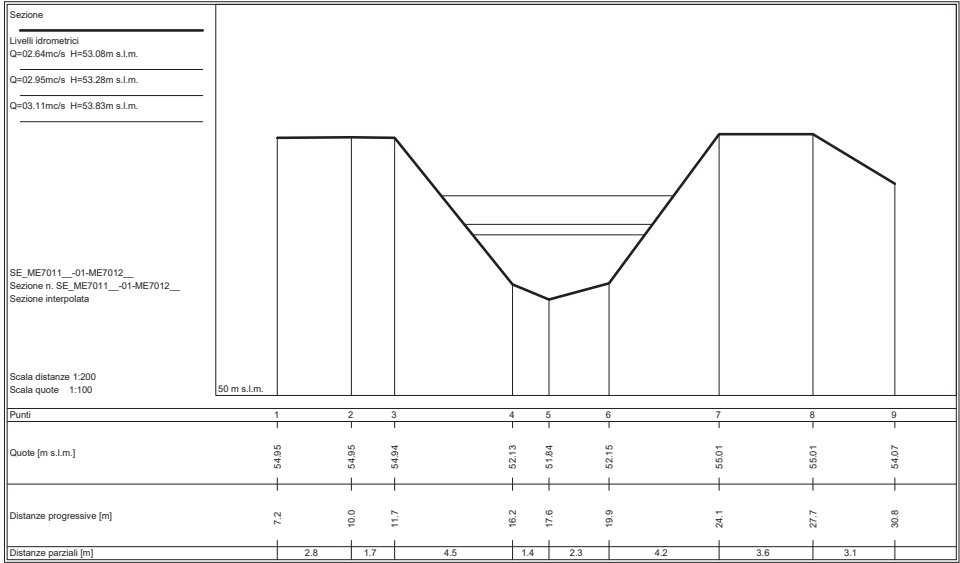

SEZIONI FLUVIALI  
FOSSO SELVAVECCHIA - FO

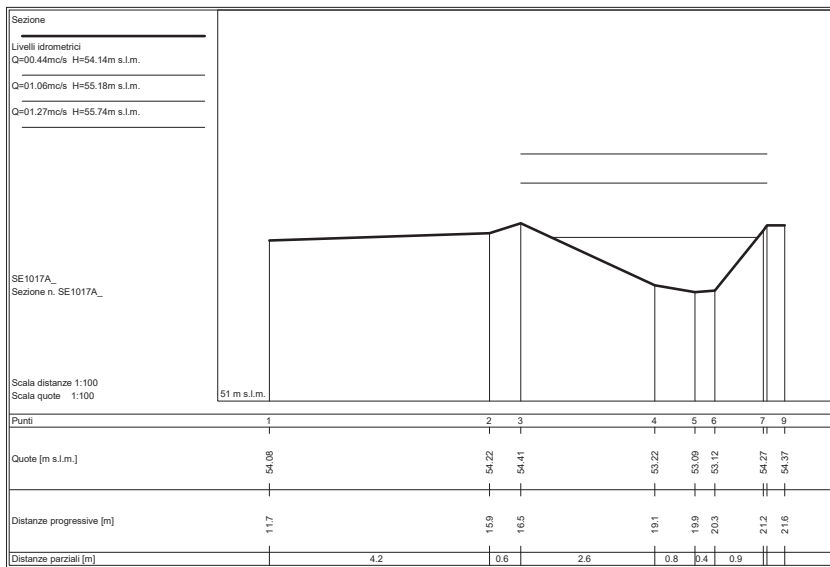
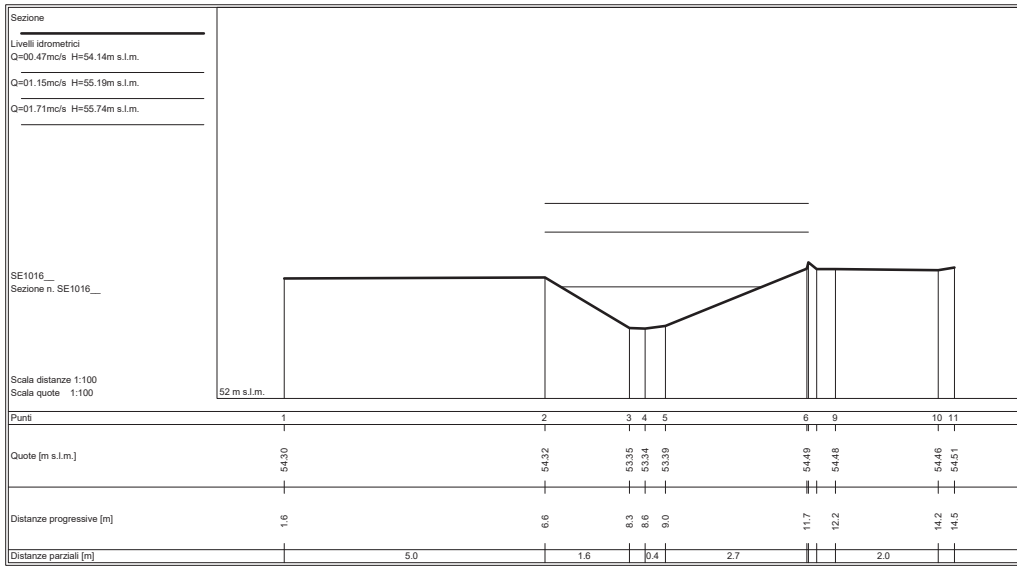

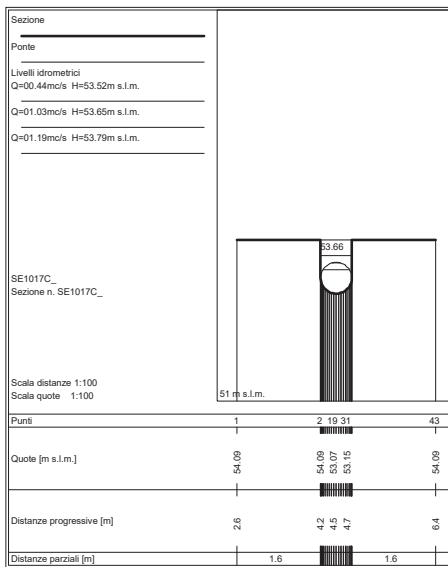
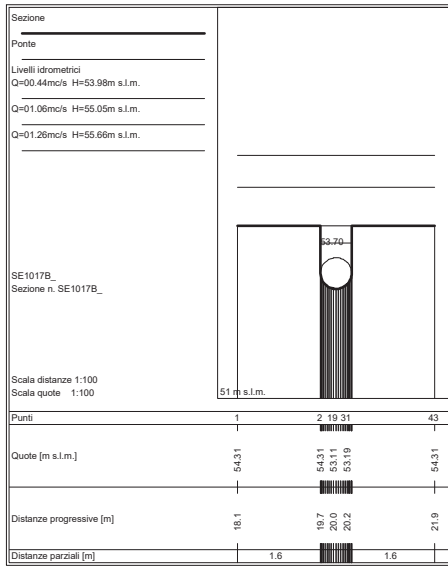



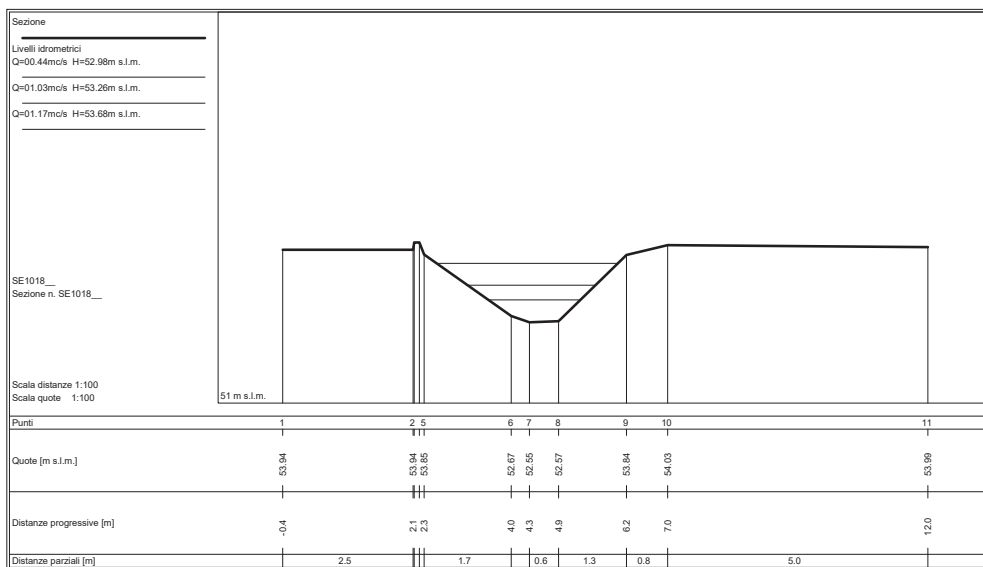
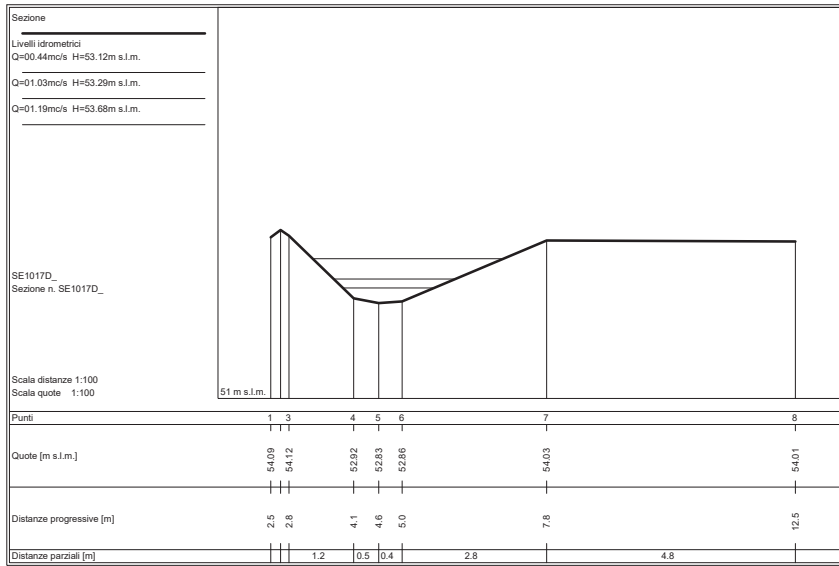

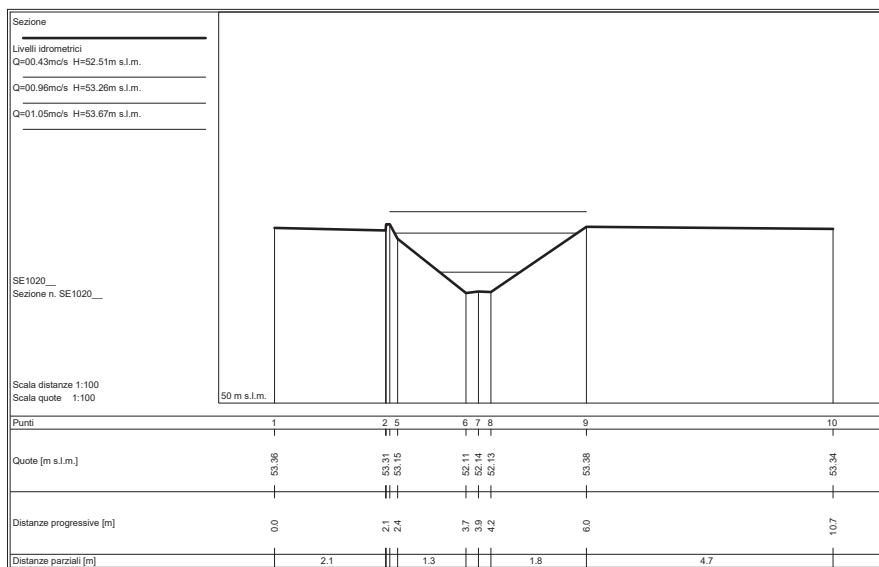
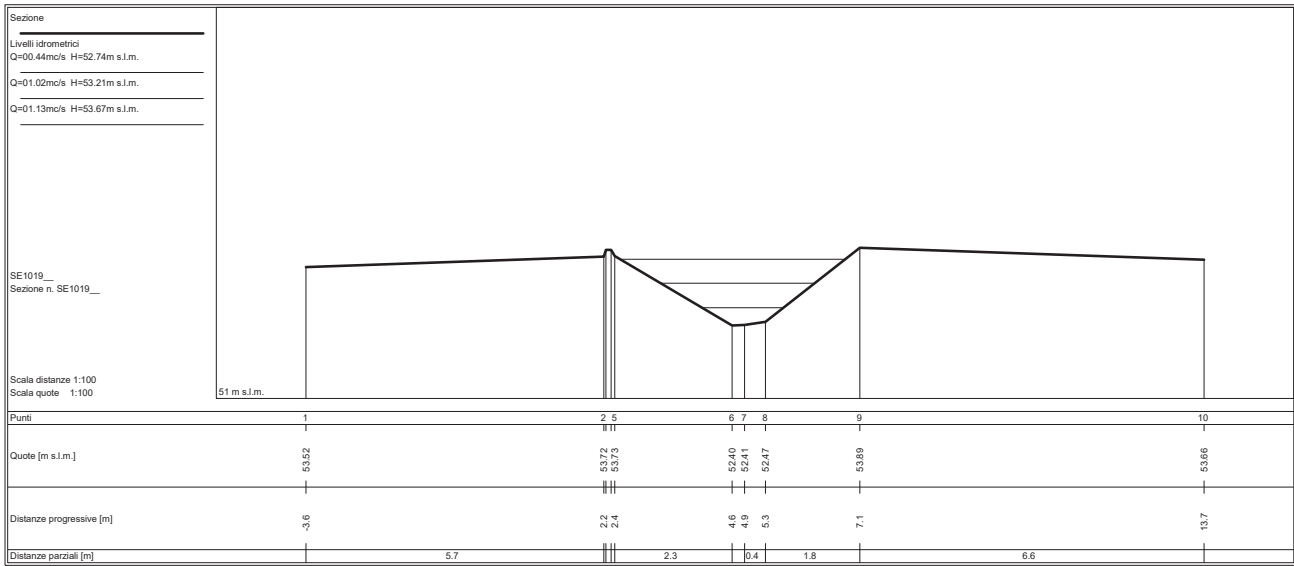

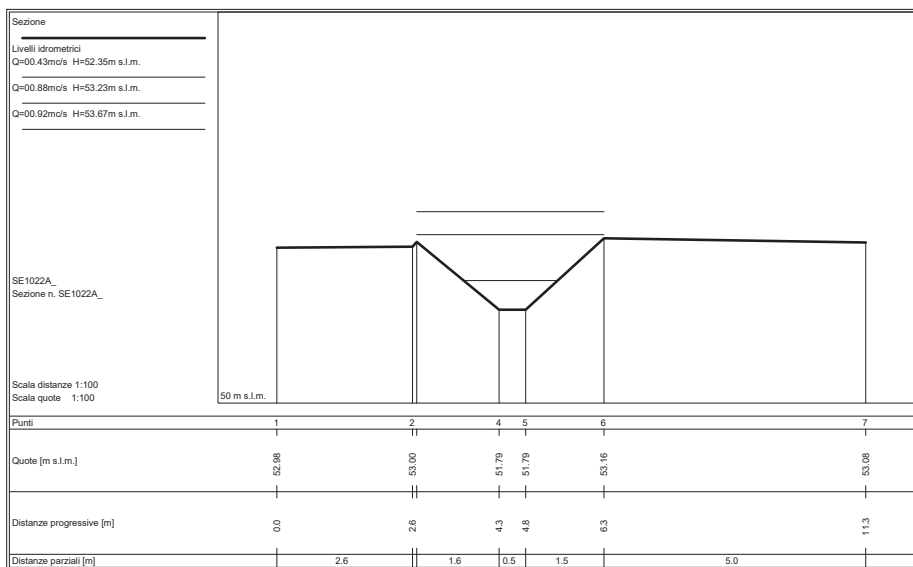
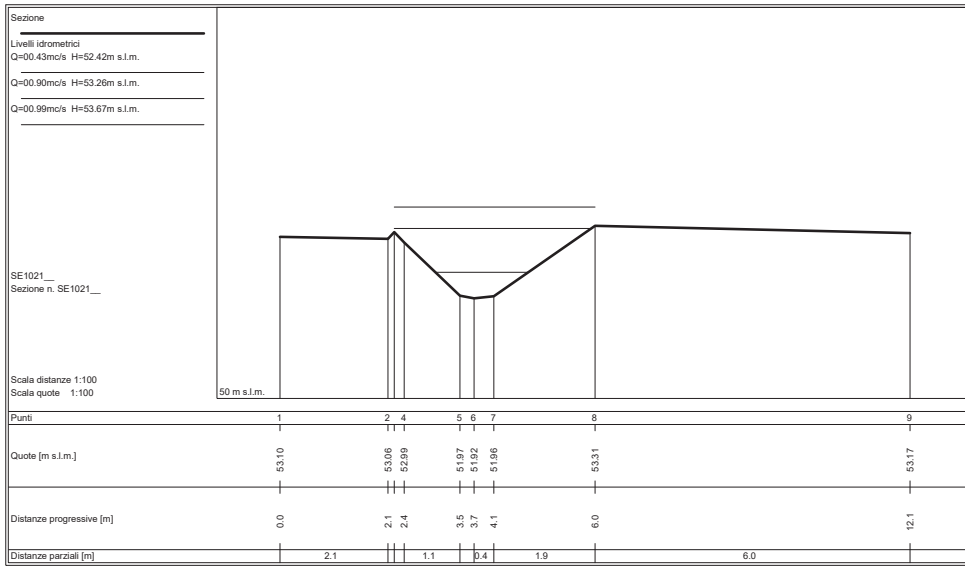

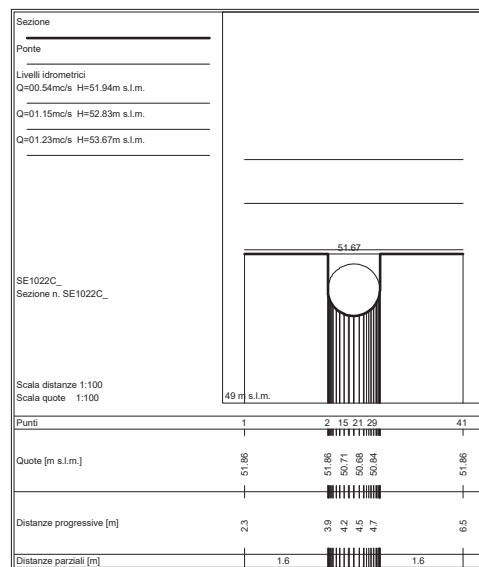
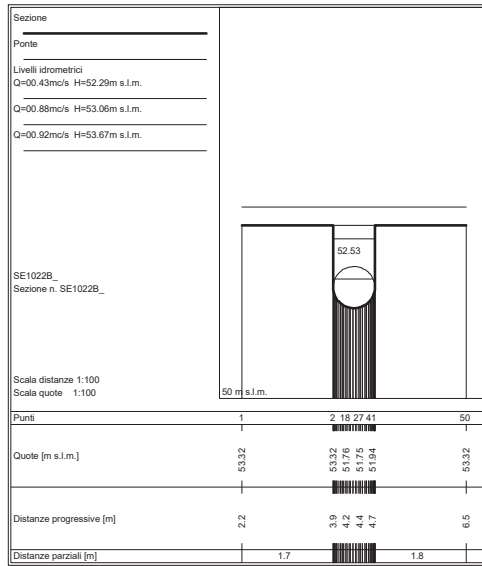

SEZIONI FLUVIALI  
FOSSO STREGALE - TRATTO 1

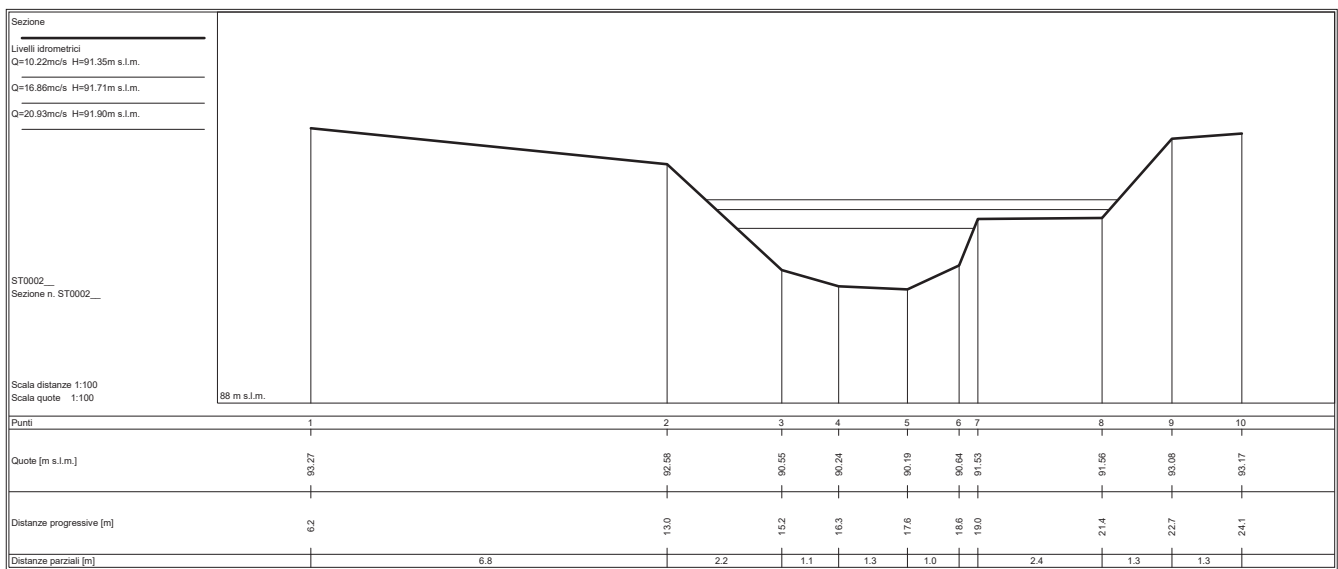
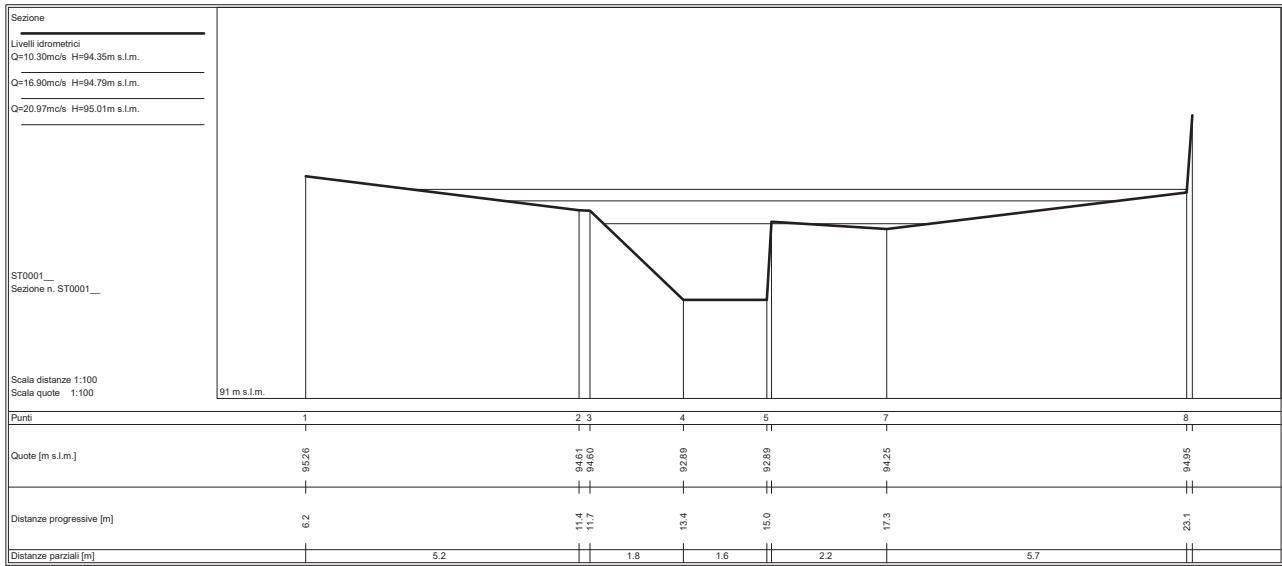

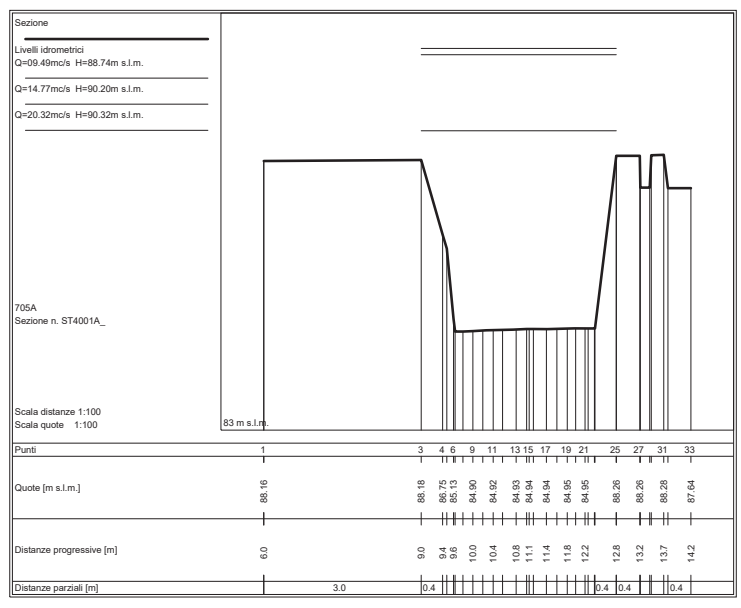
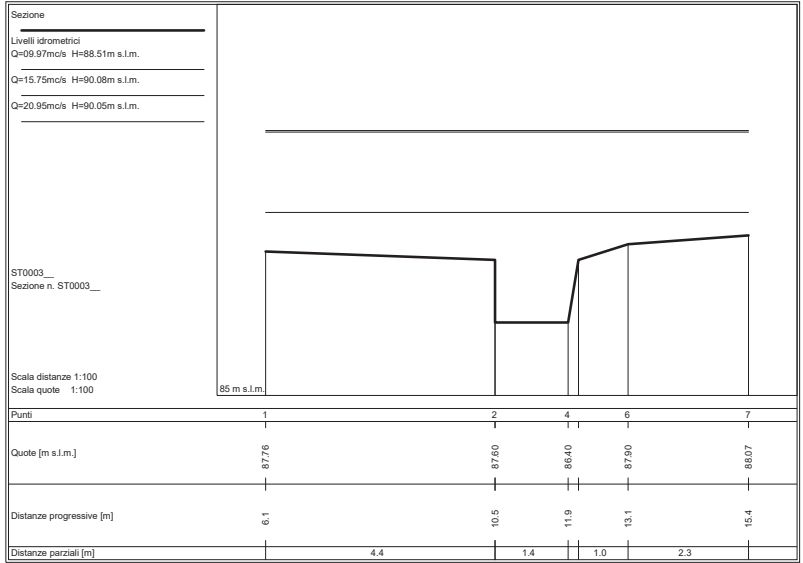

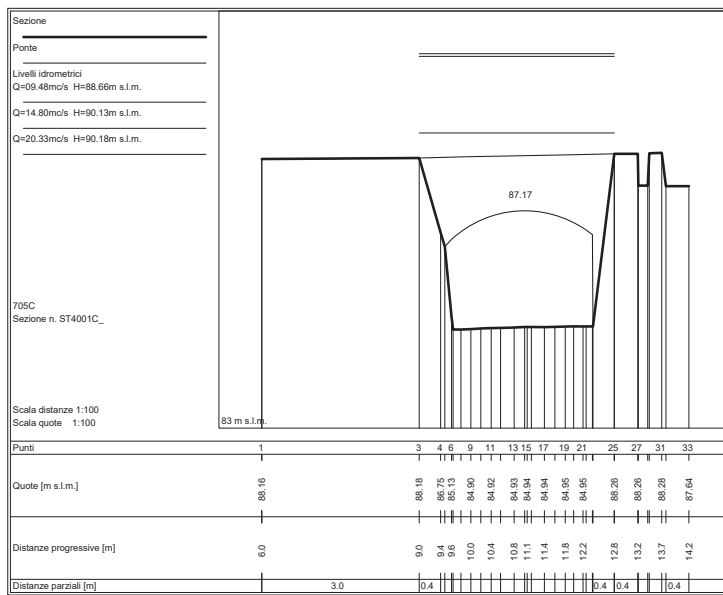
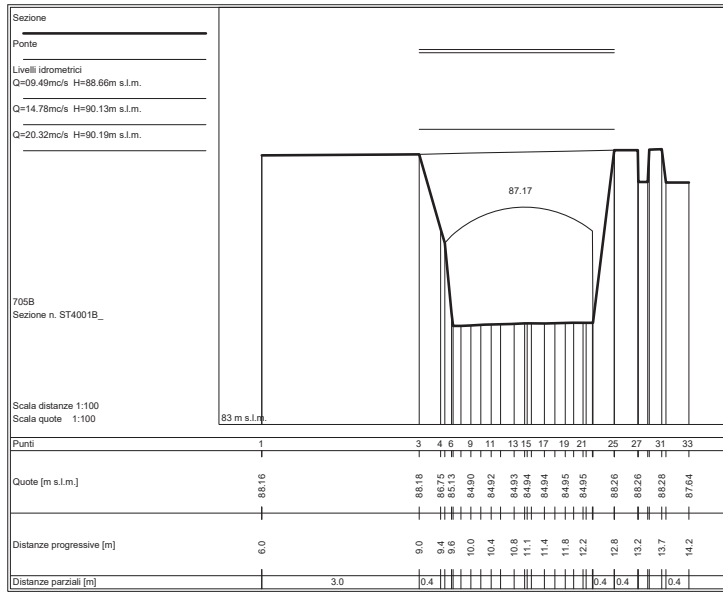



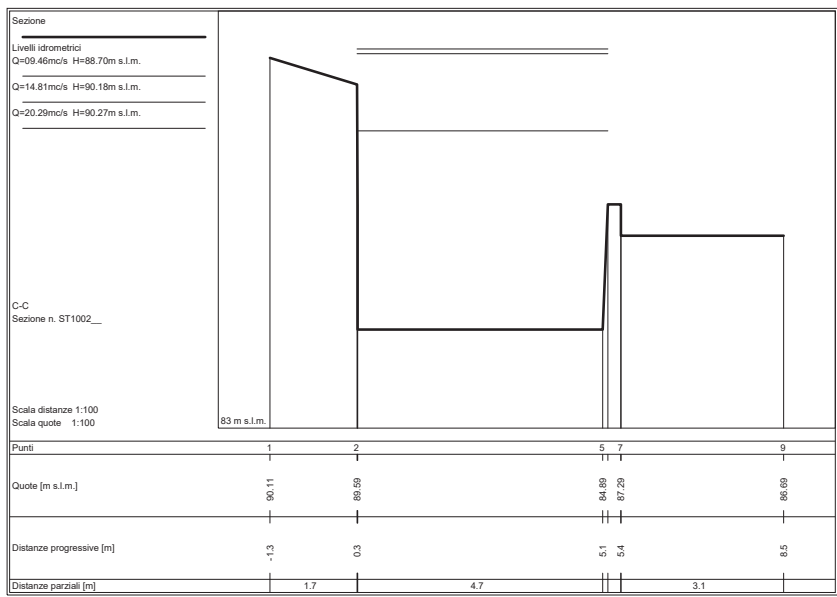
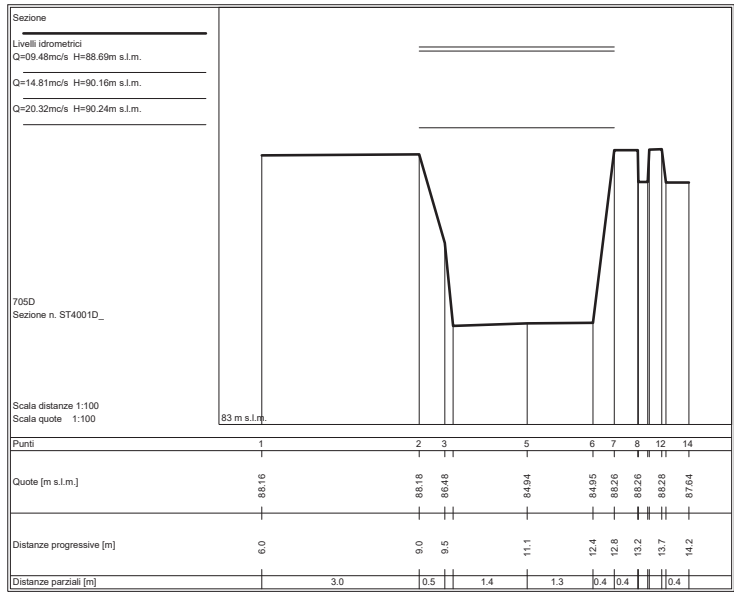

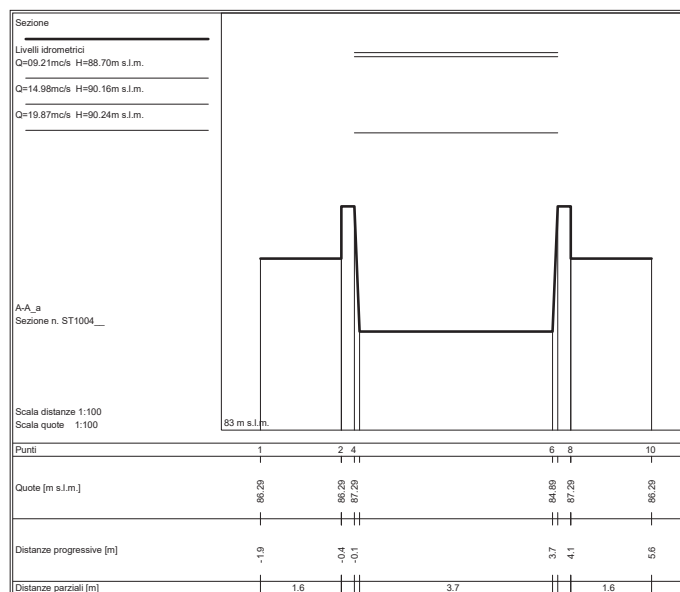
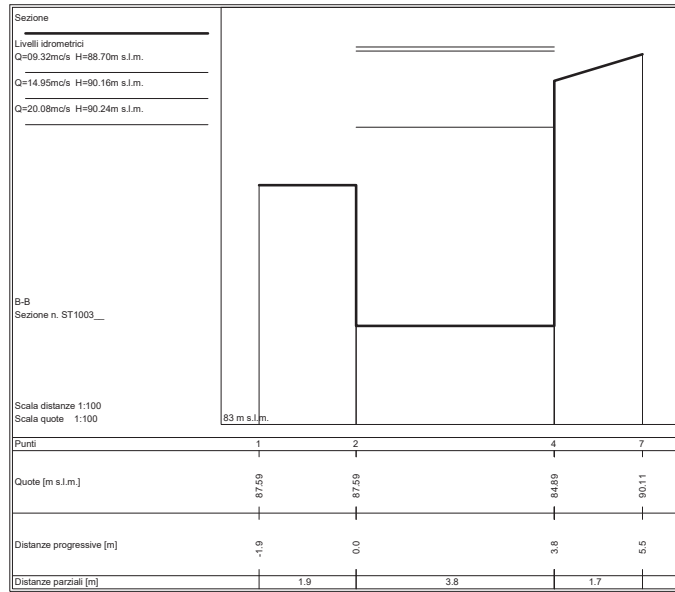

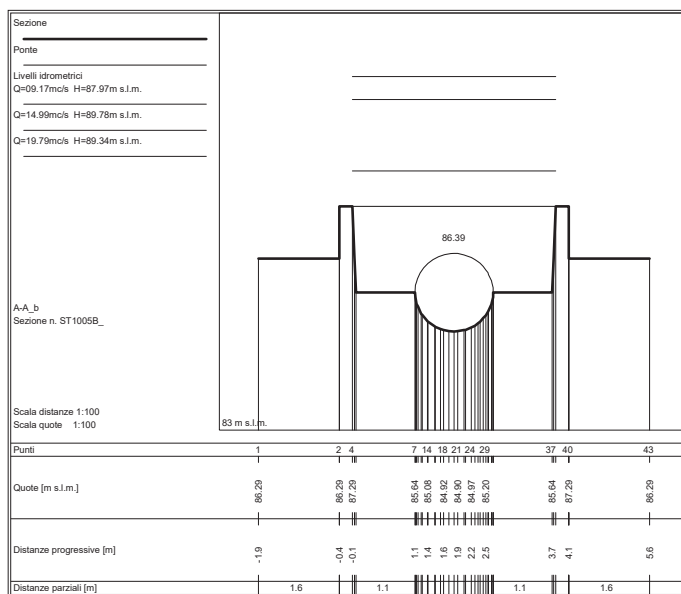
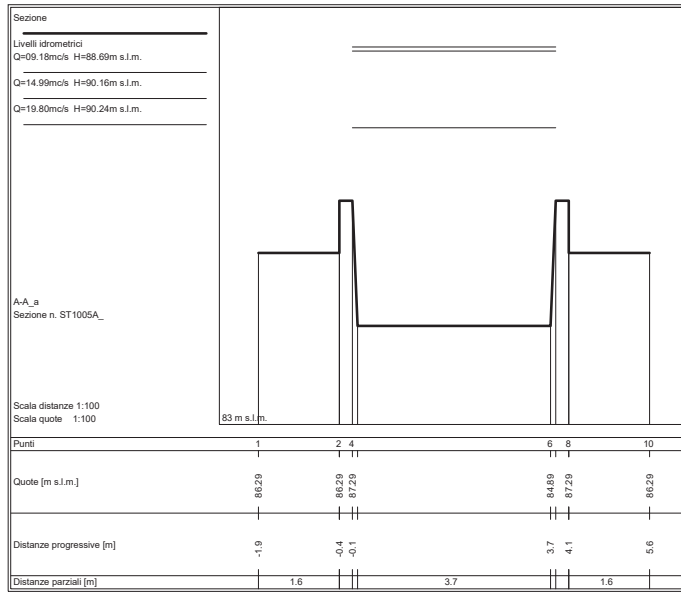

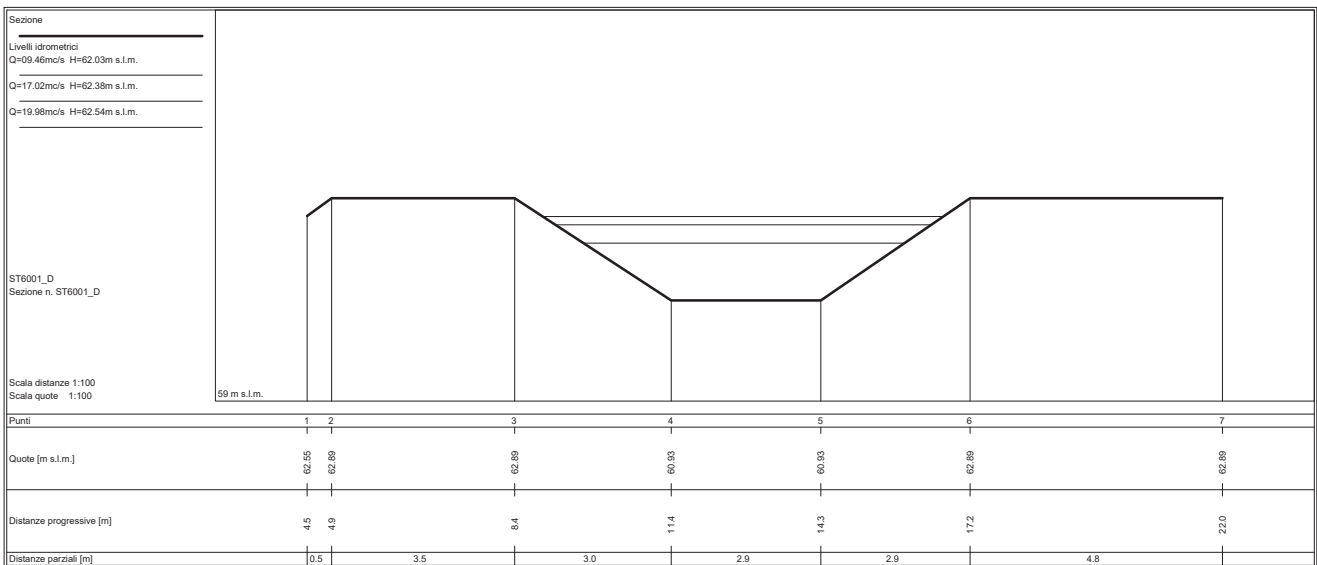
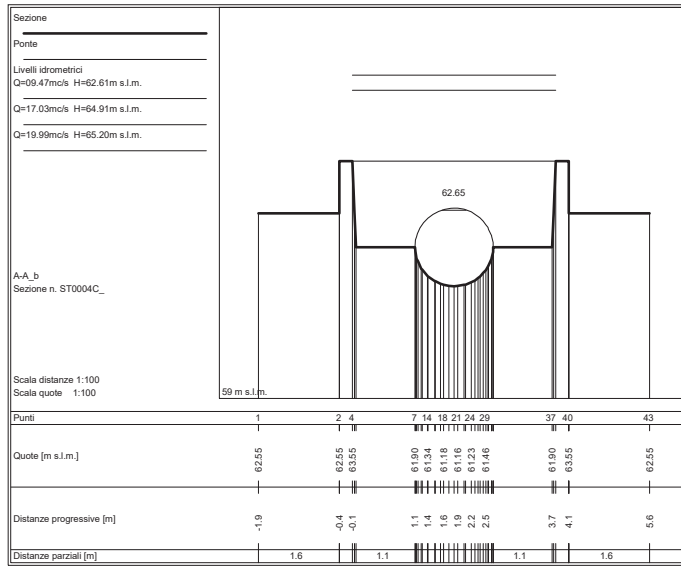

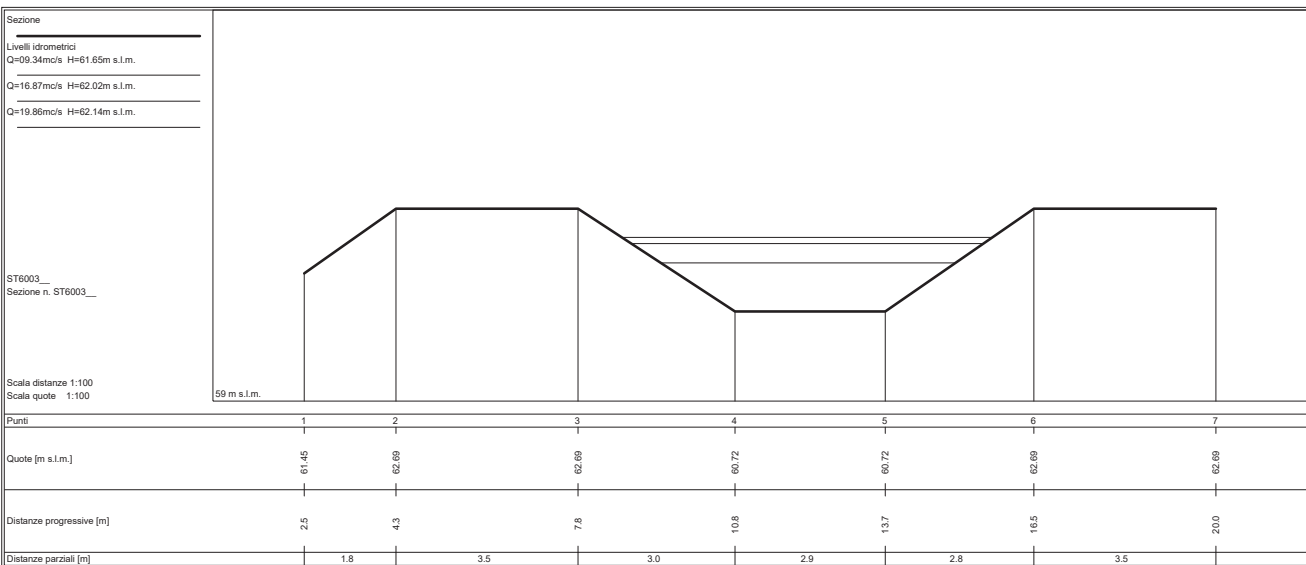
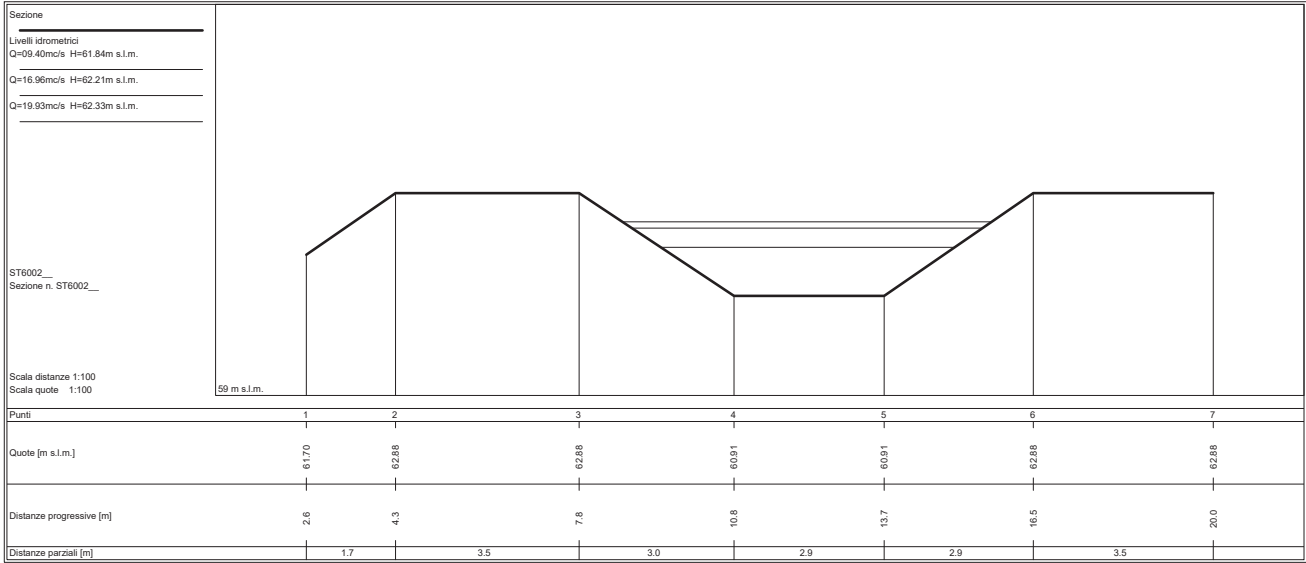

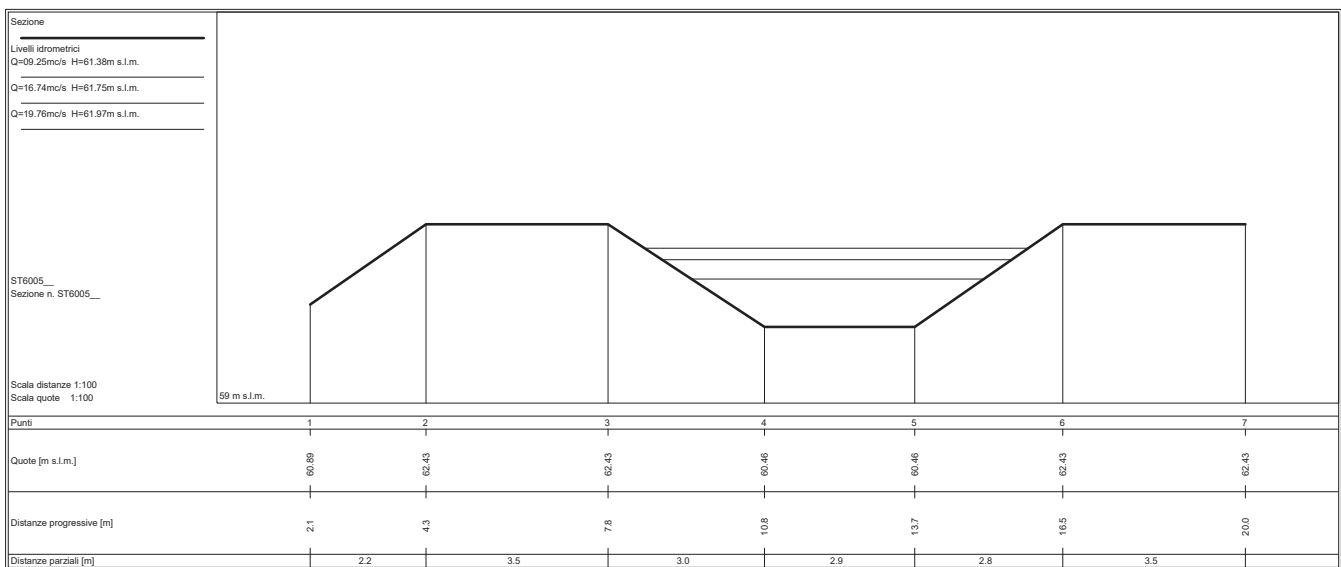
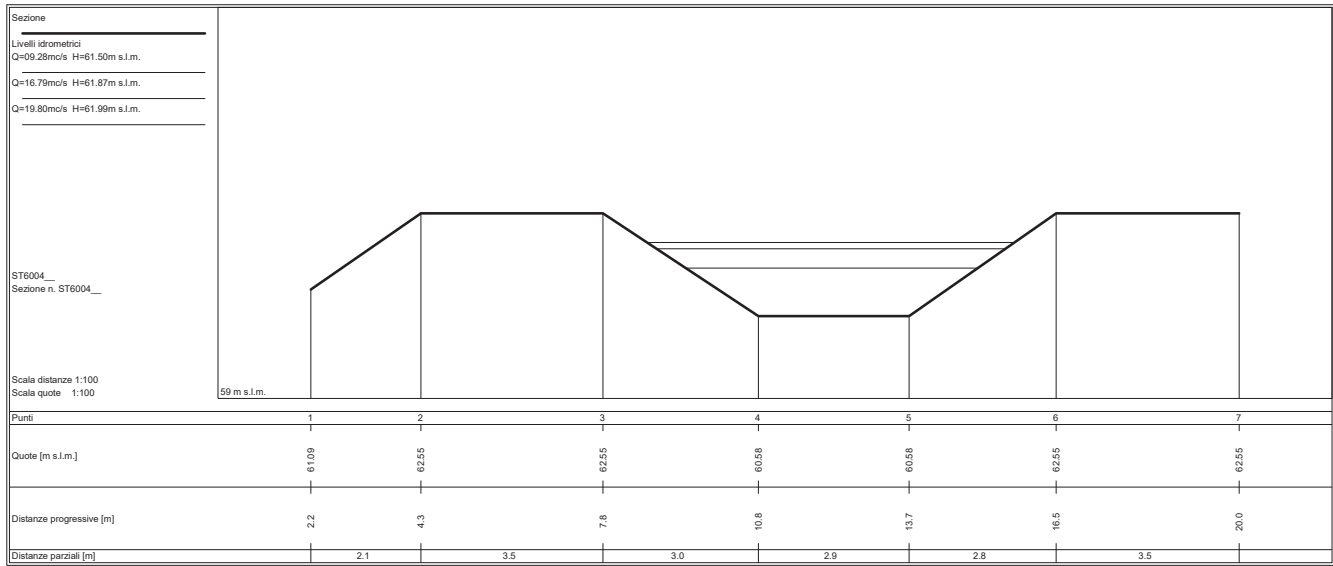

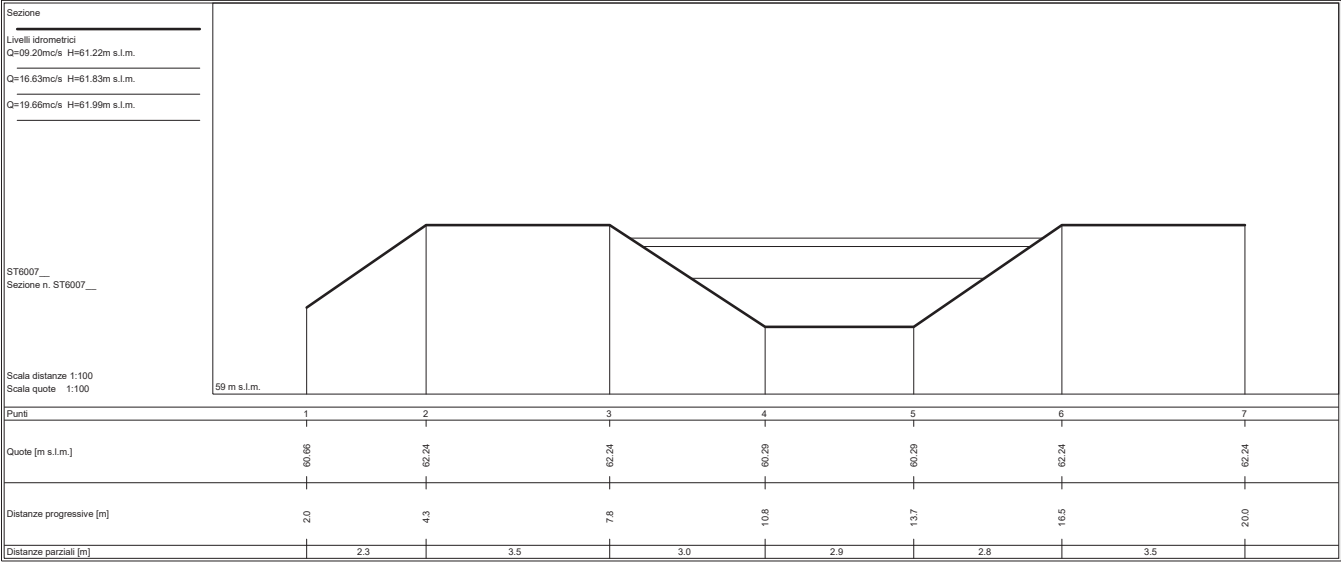
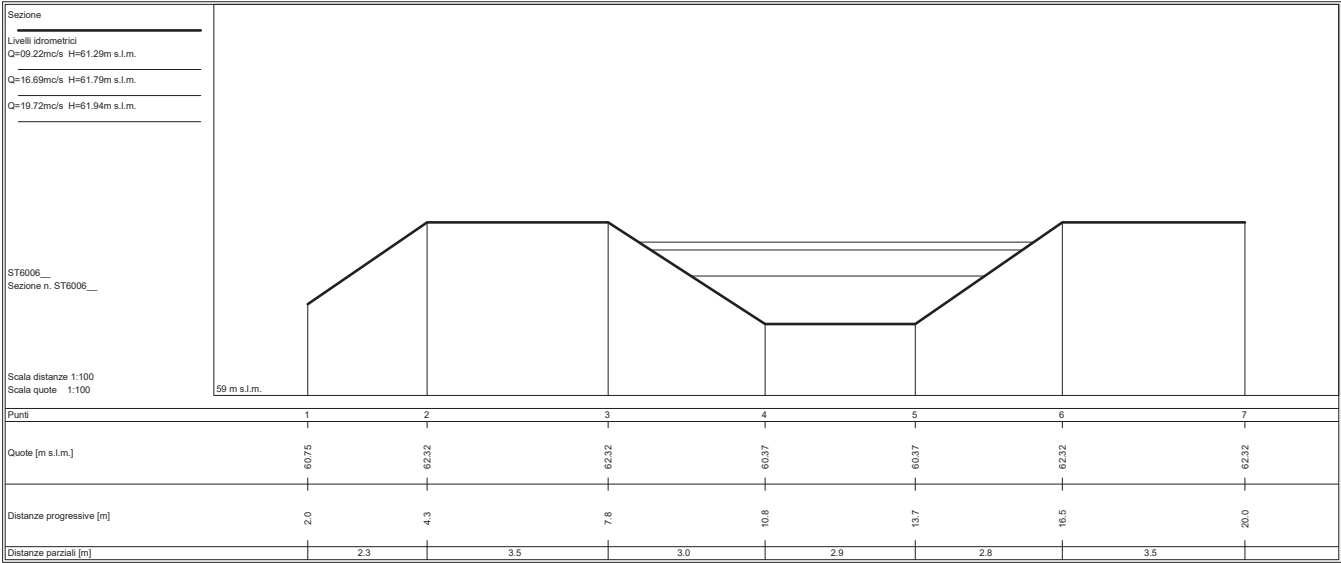

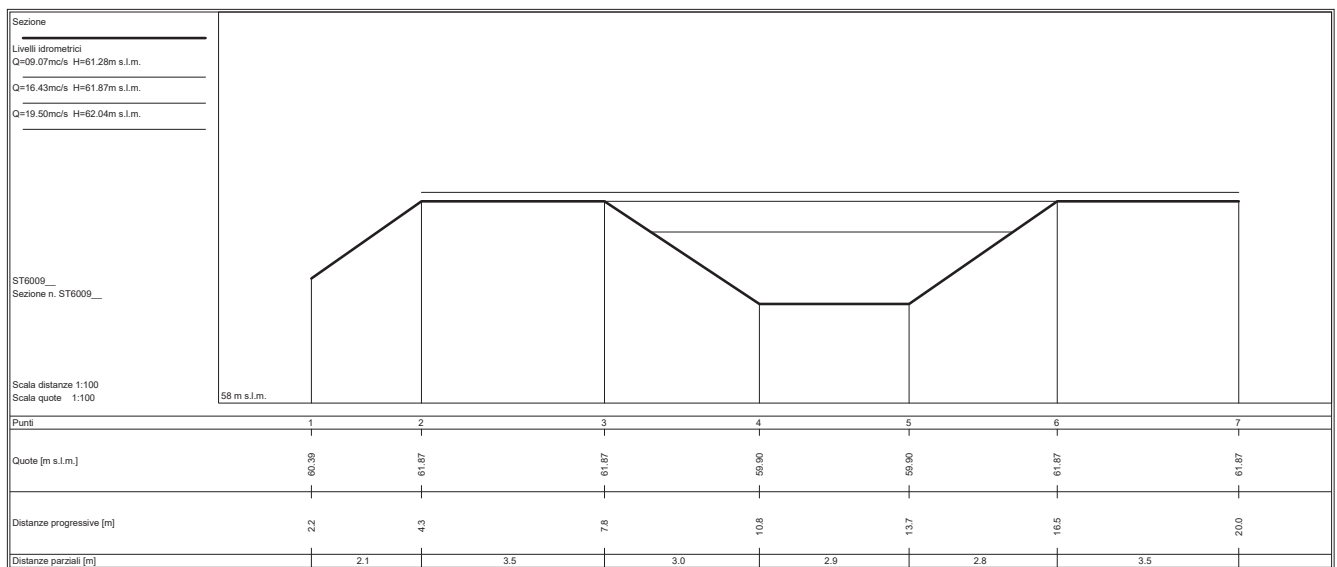
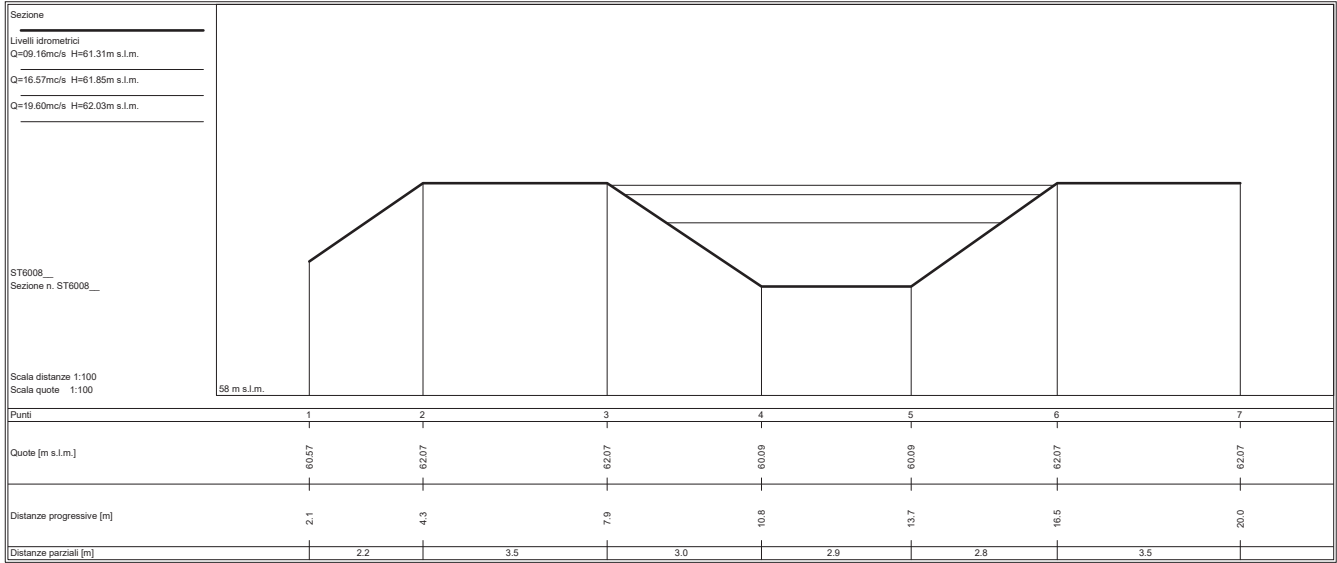



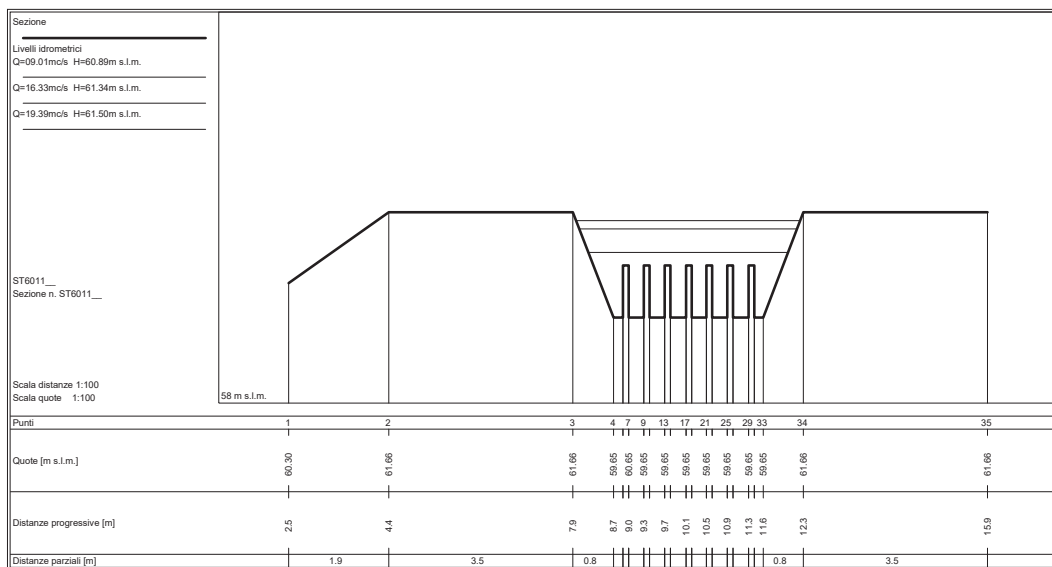
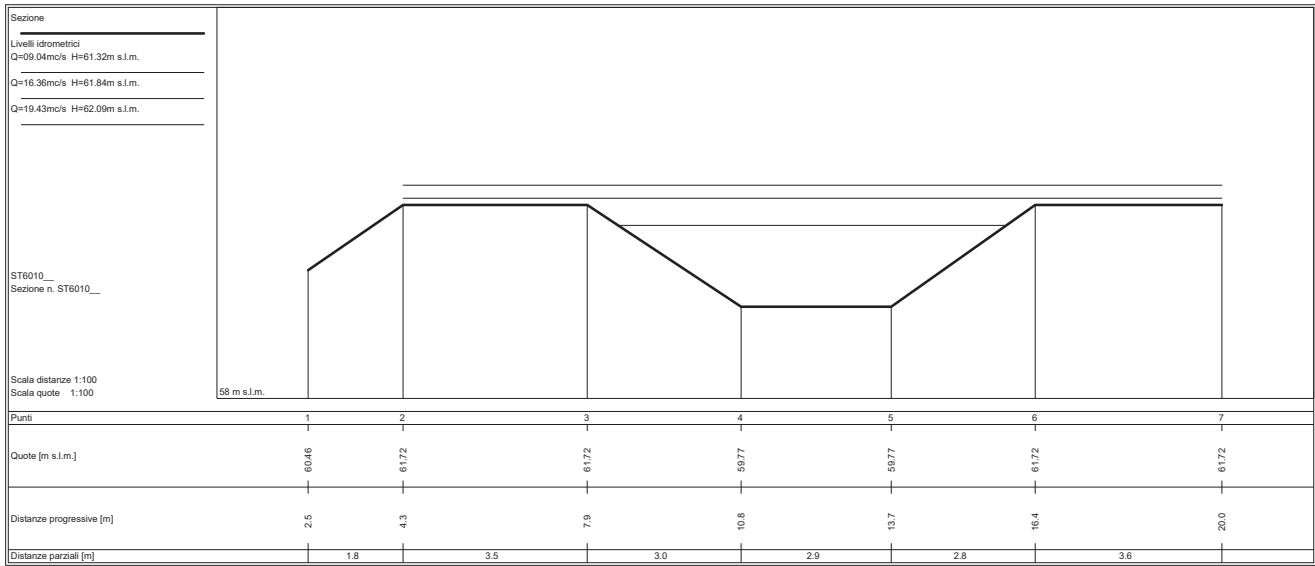

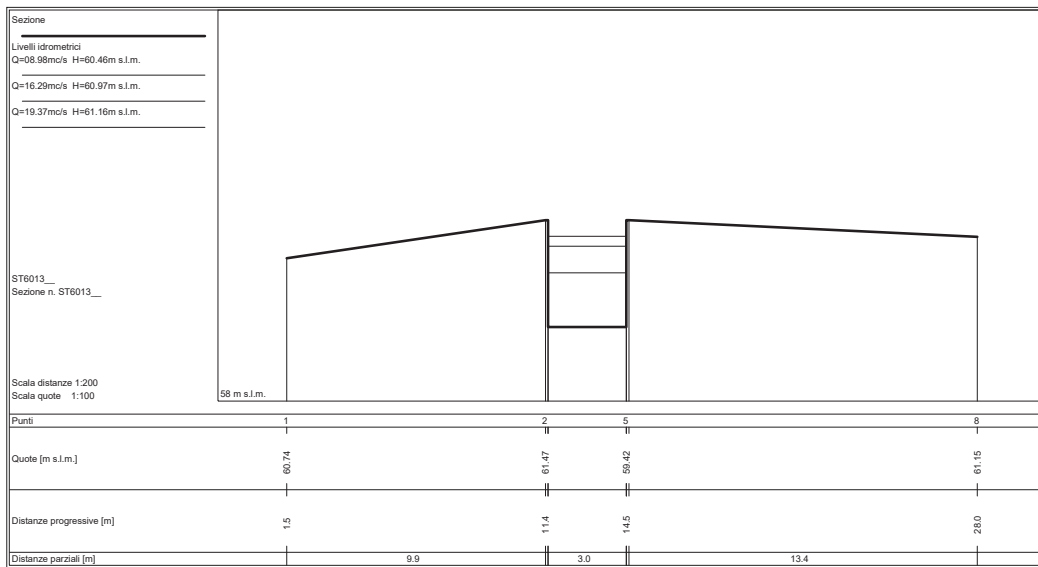
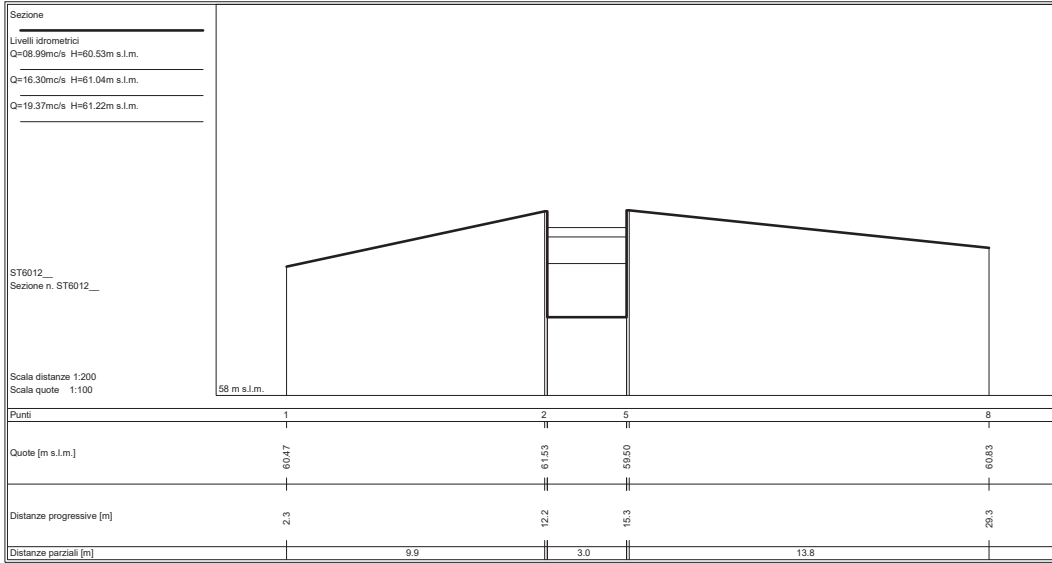

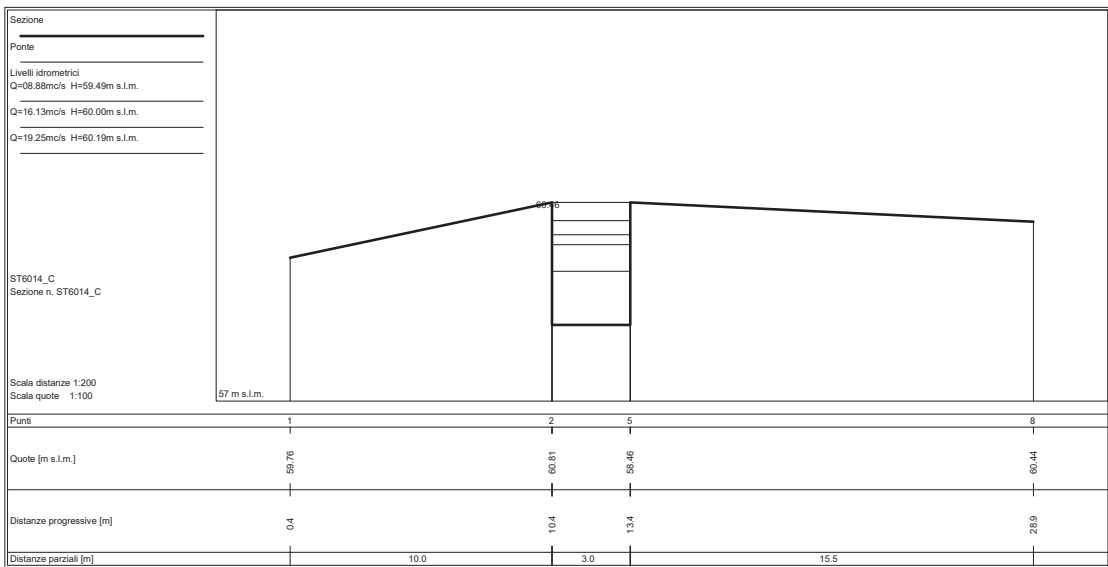
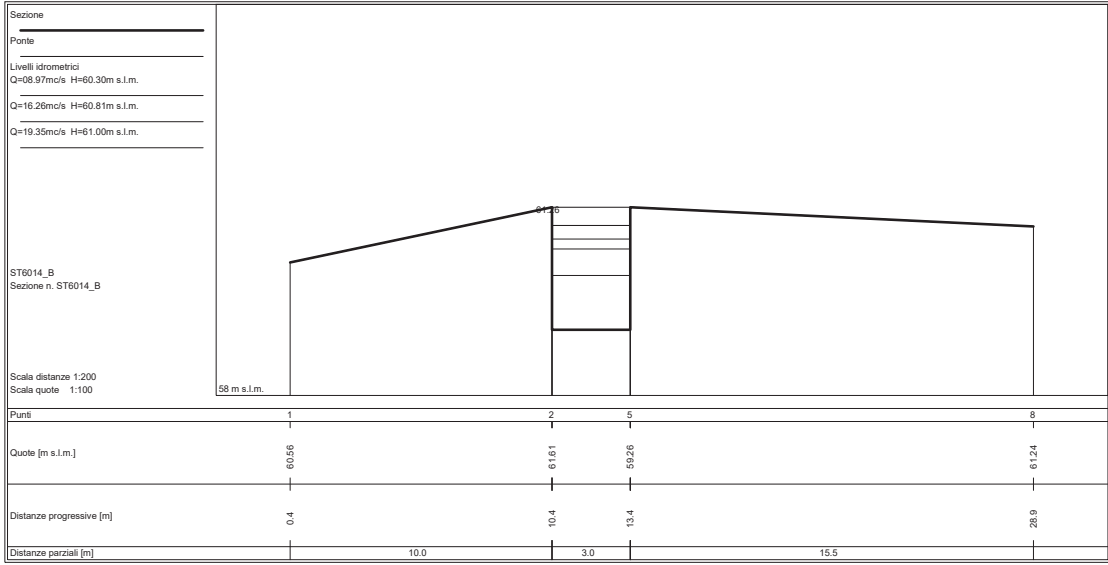

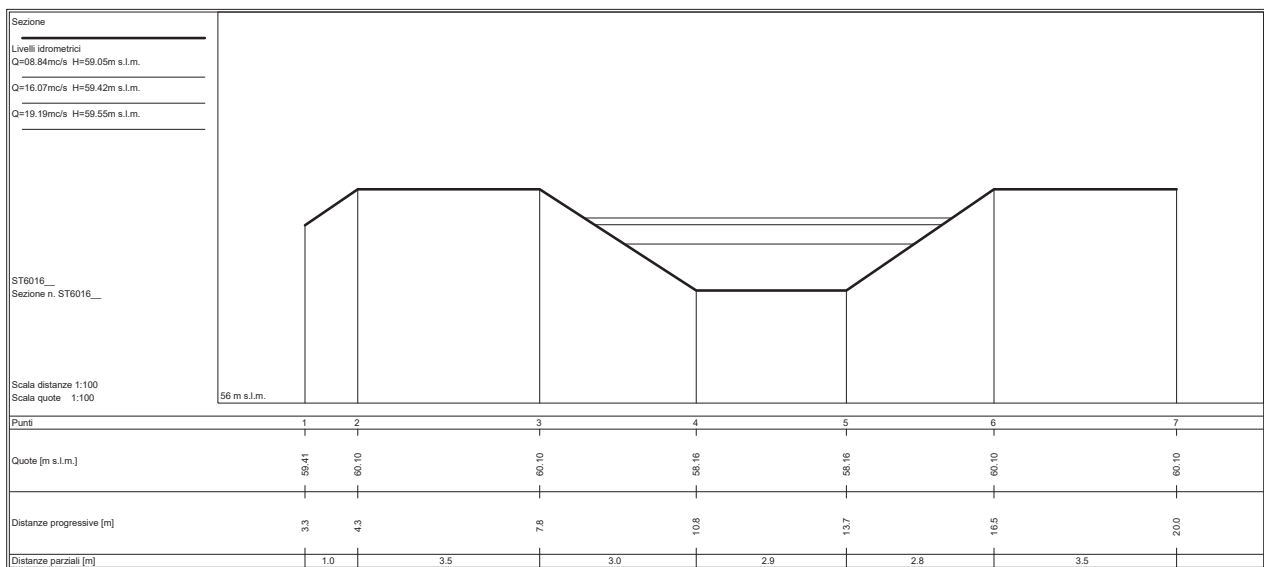
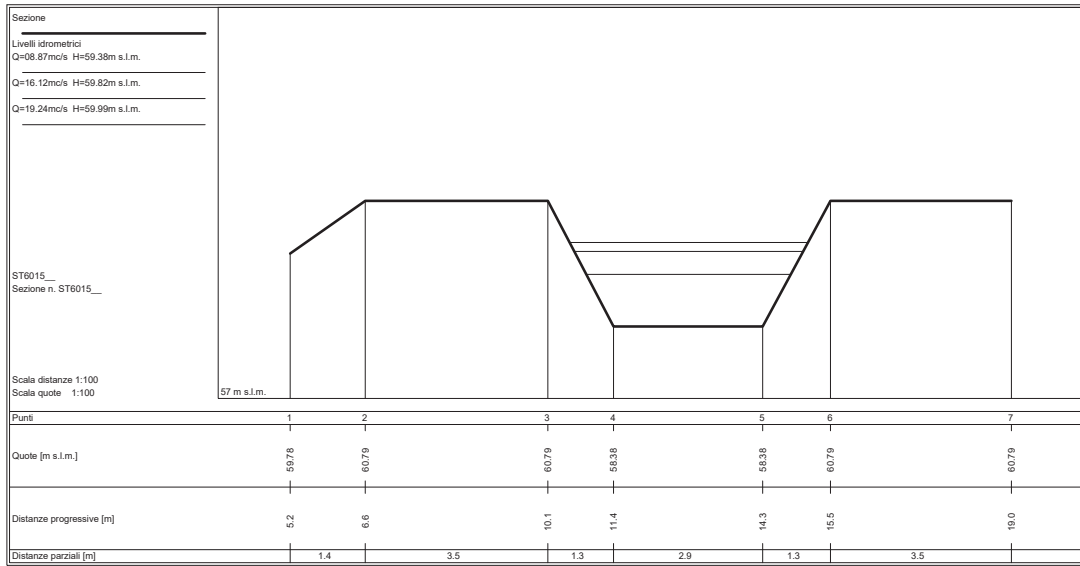

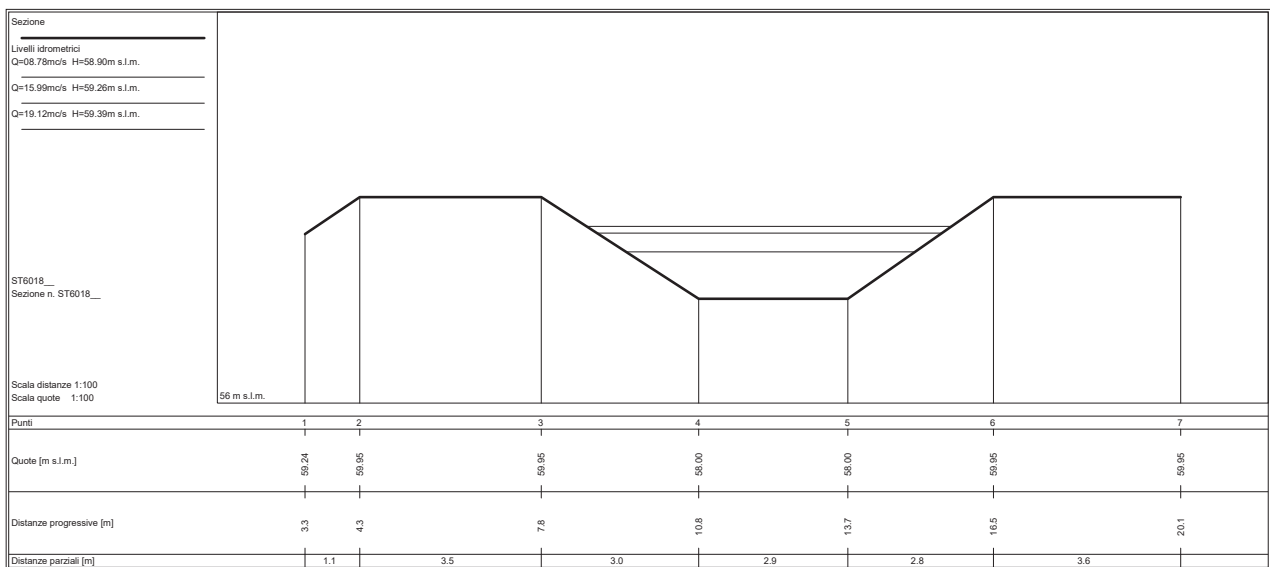
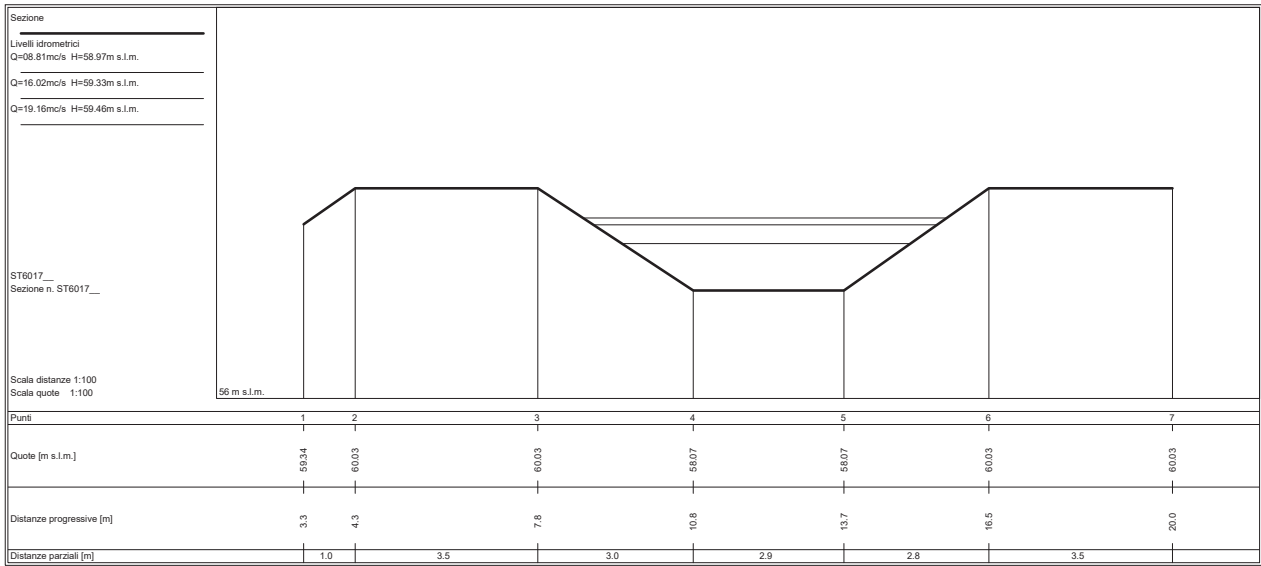

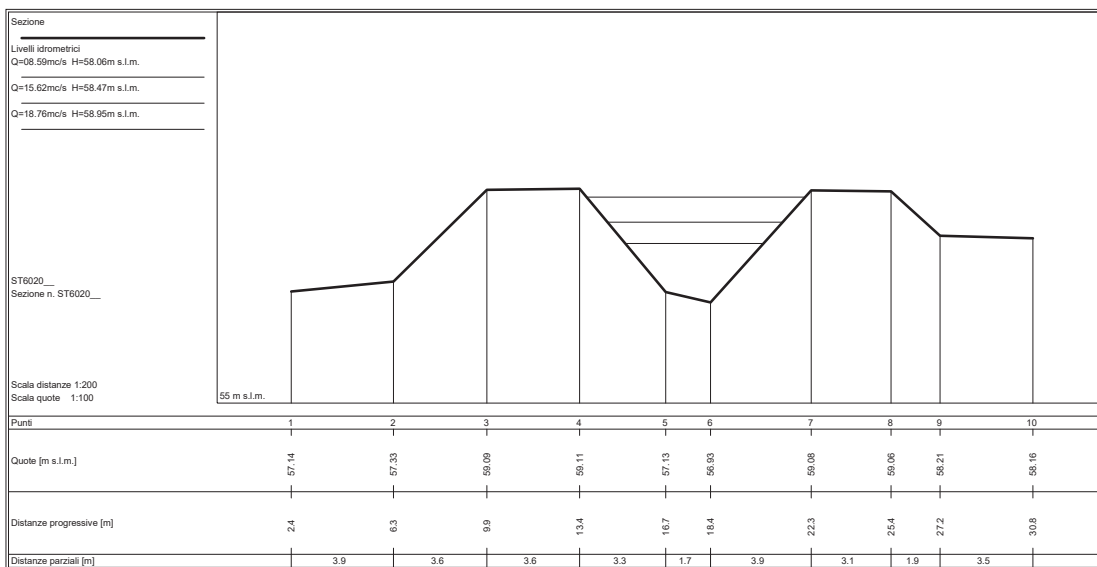
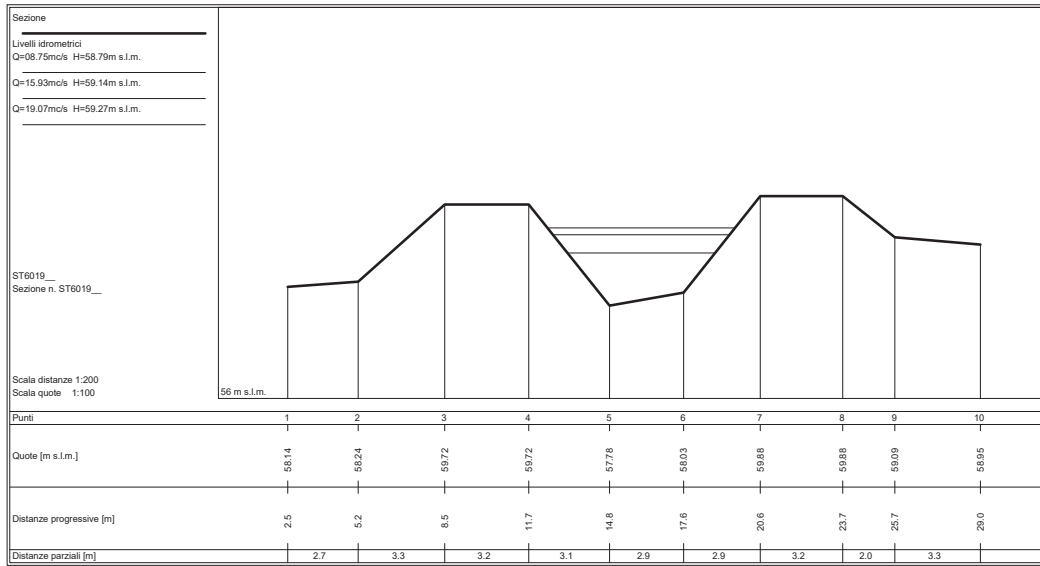

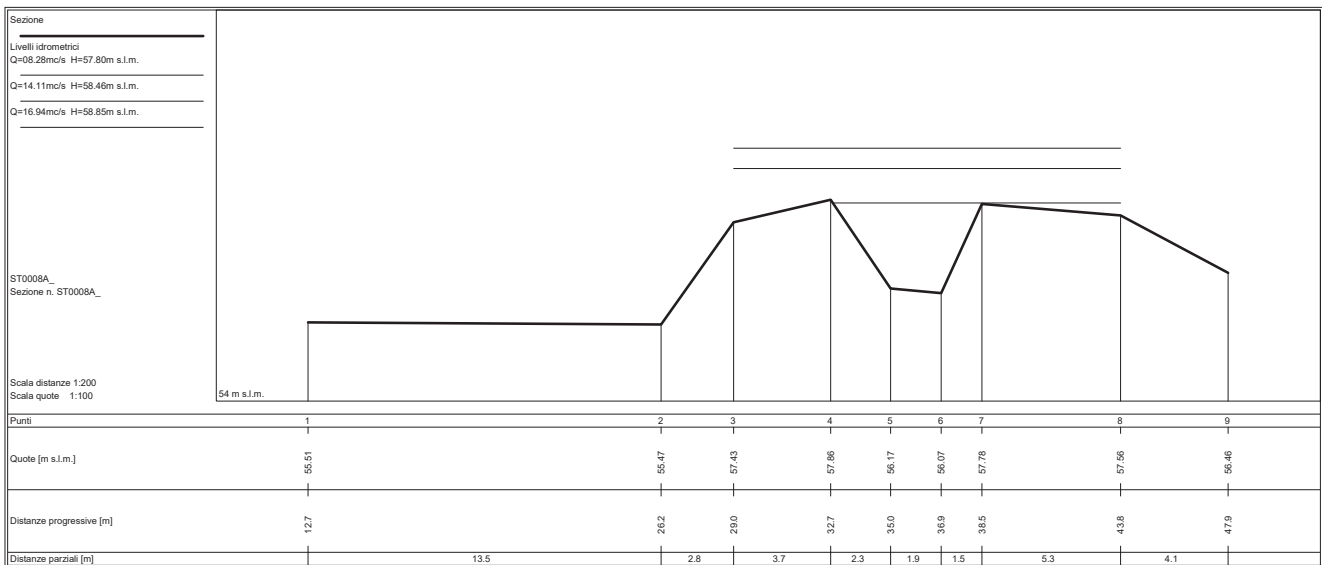
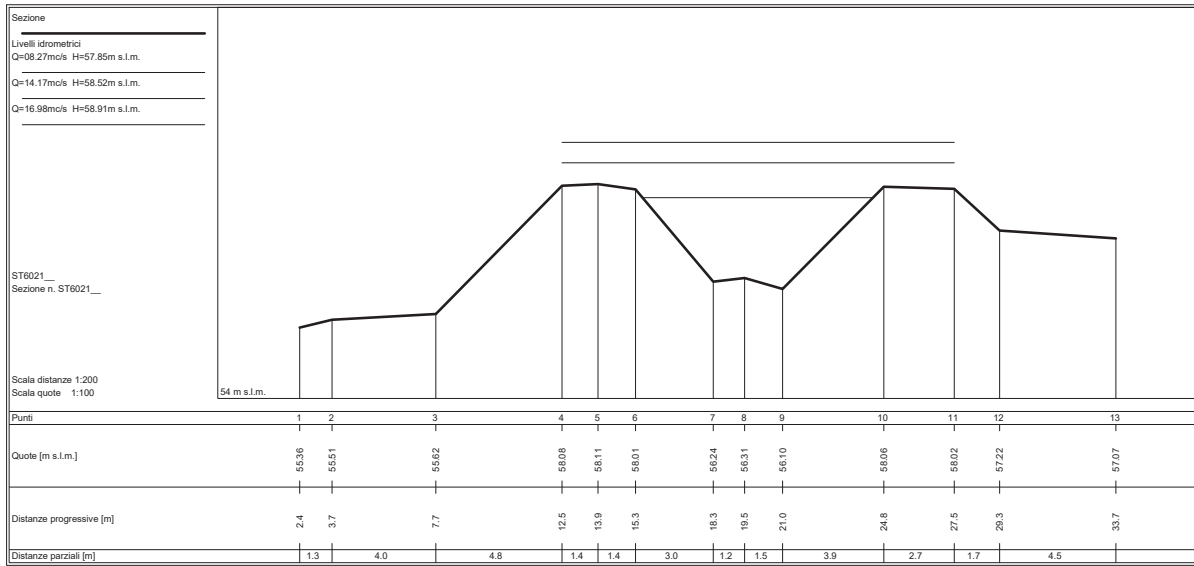





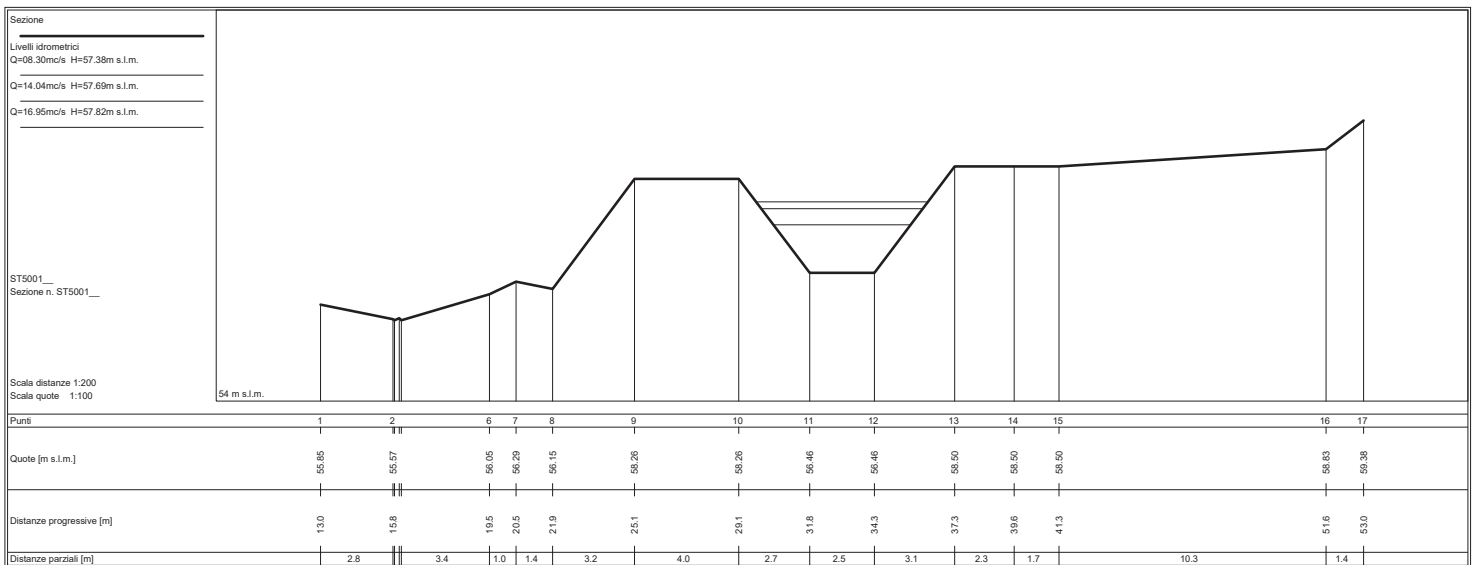
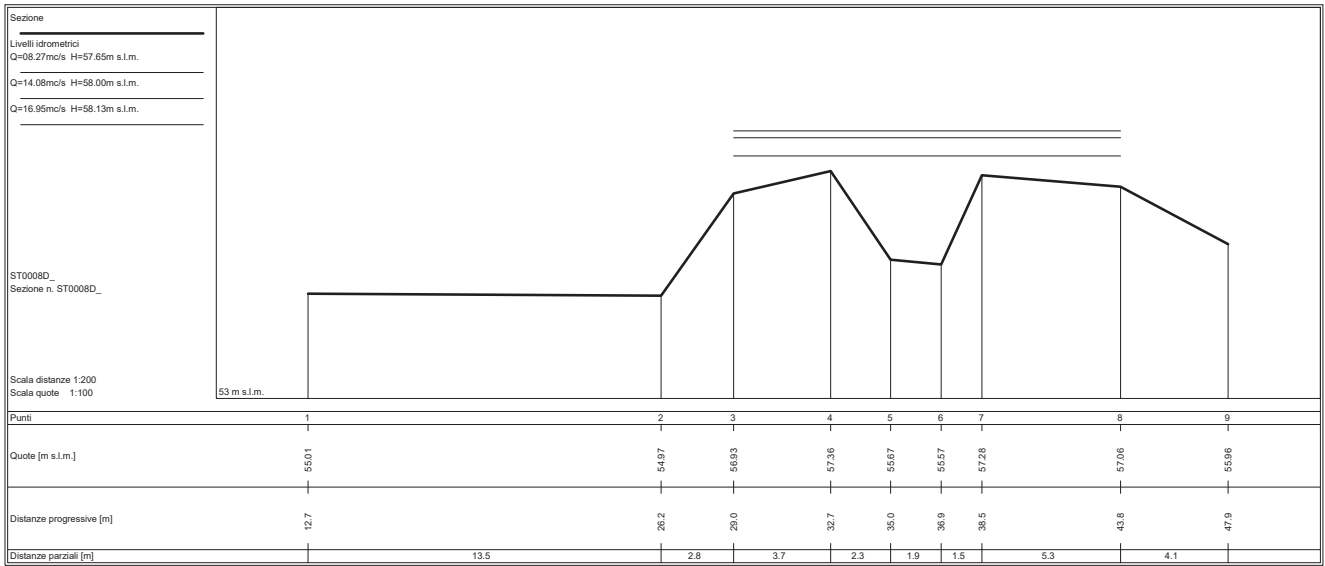

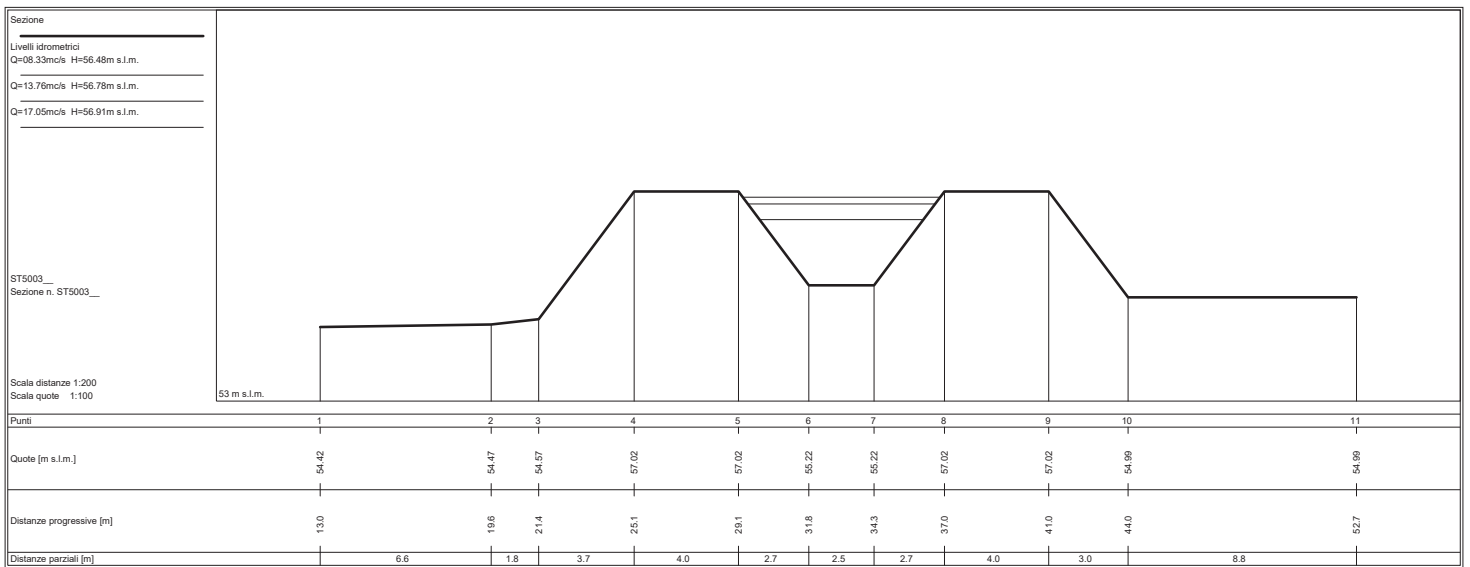
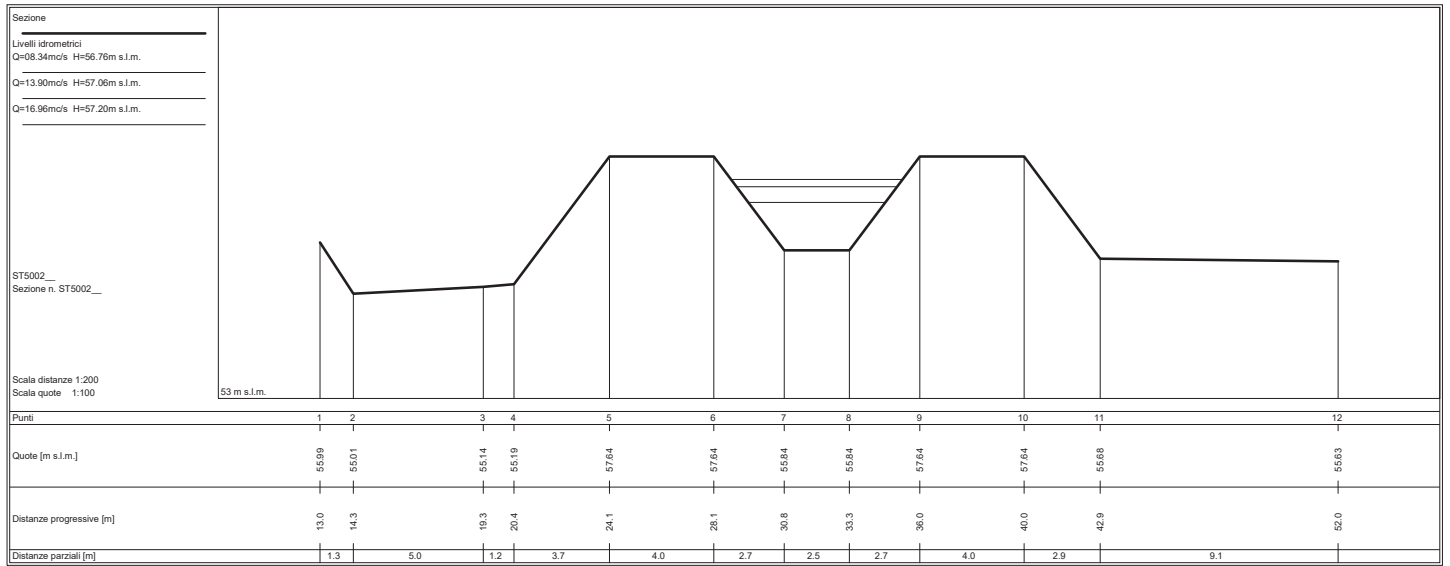

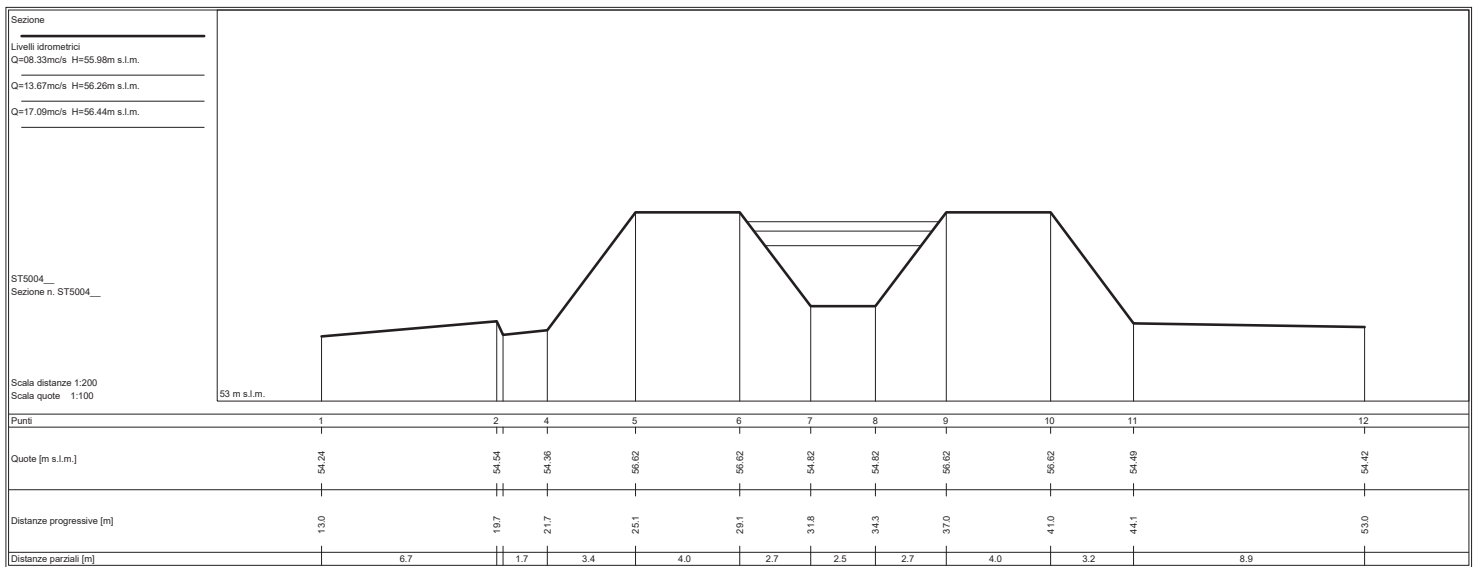
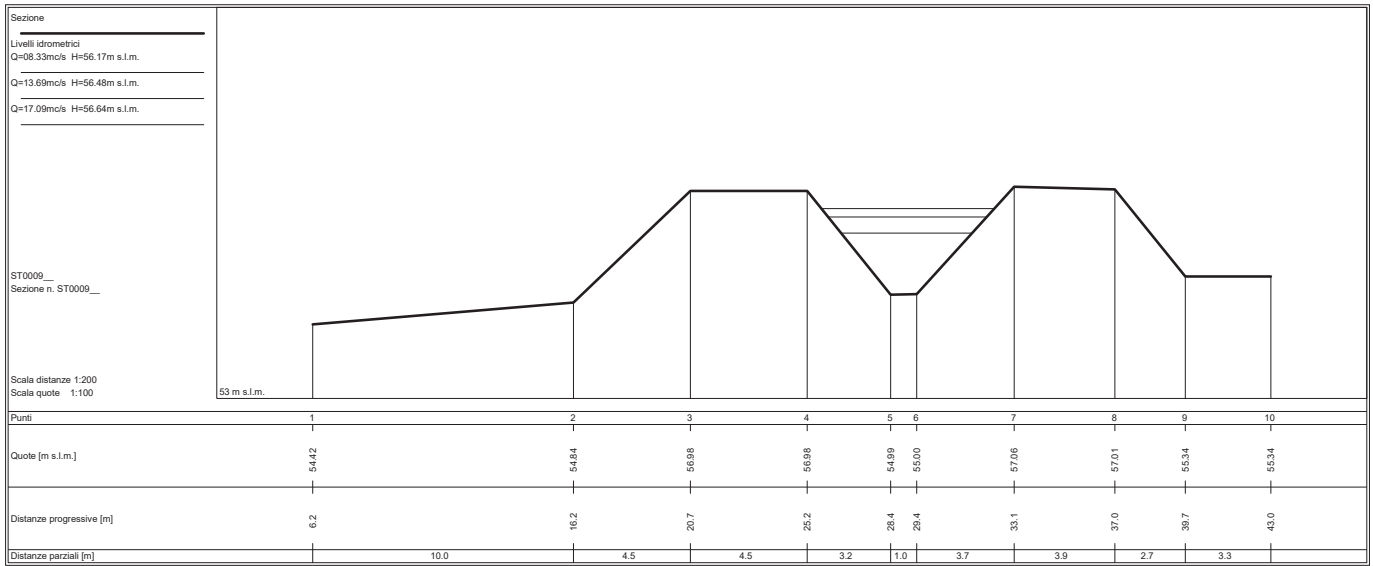

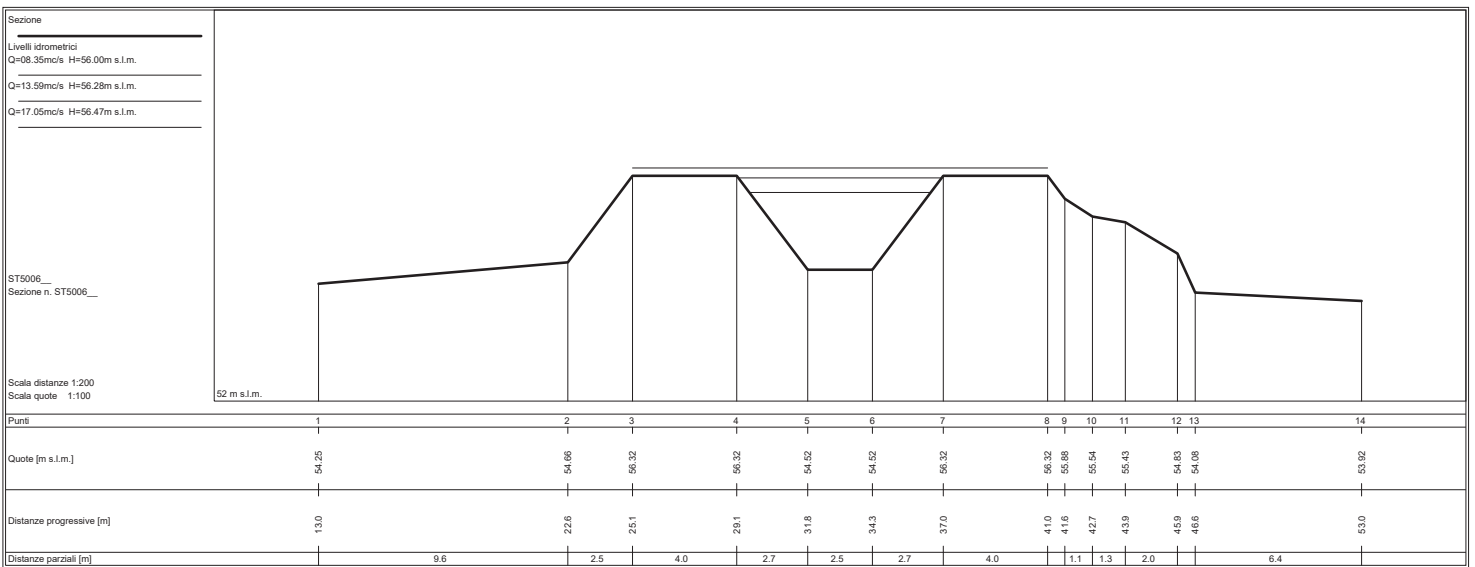
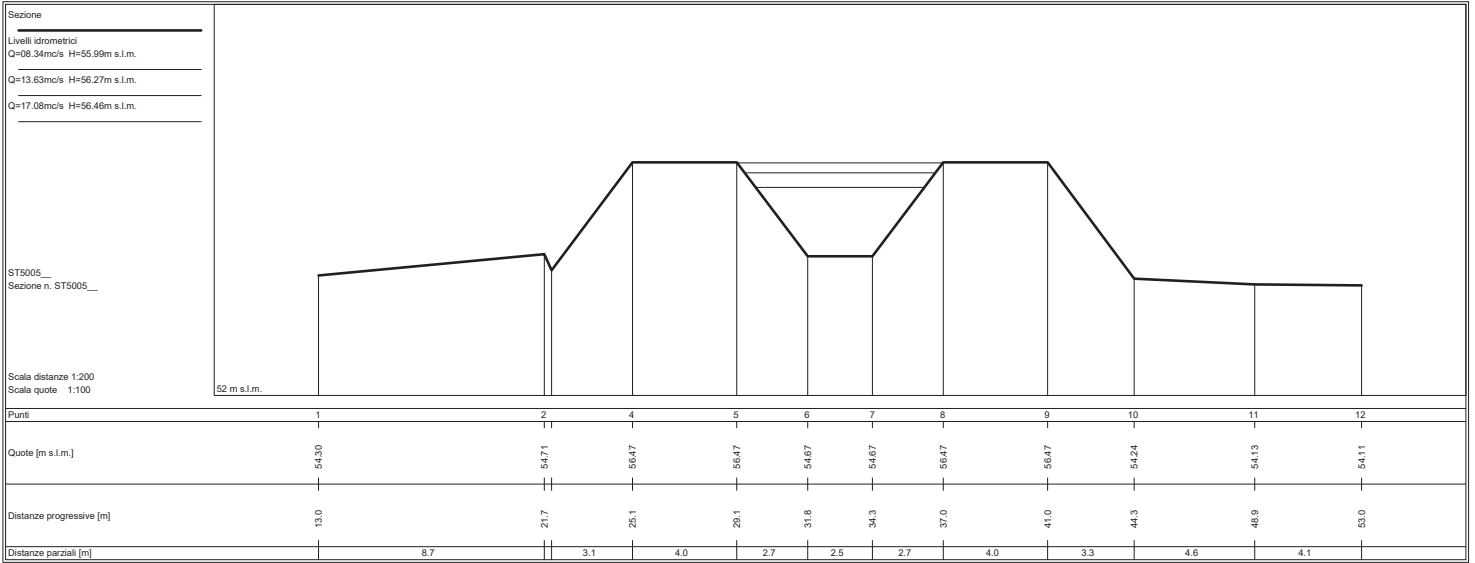

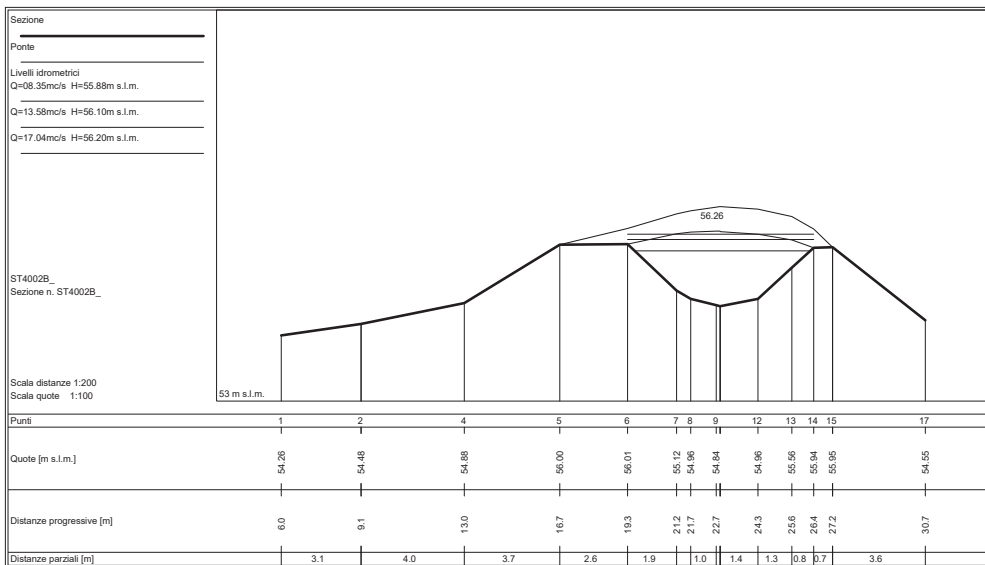
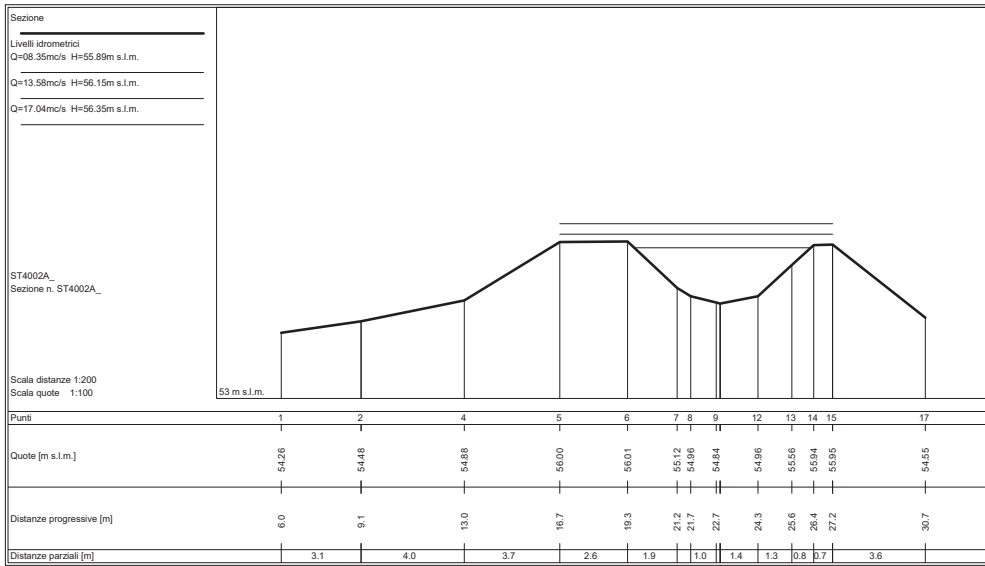

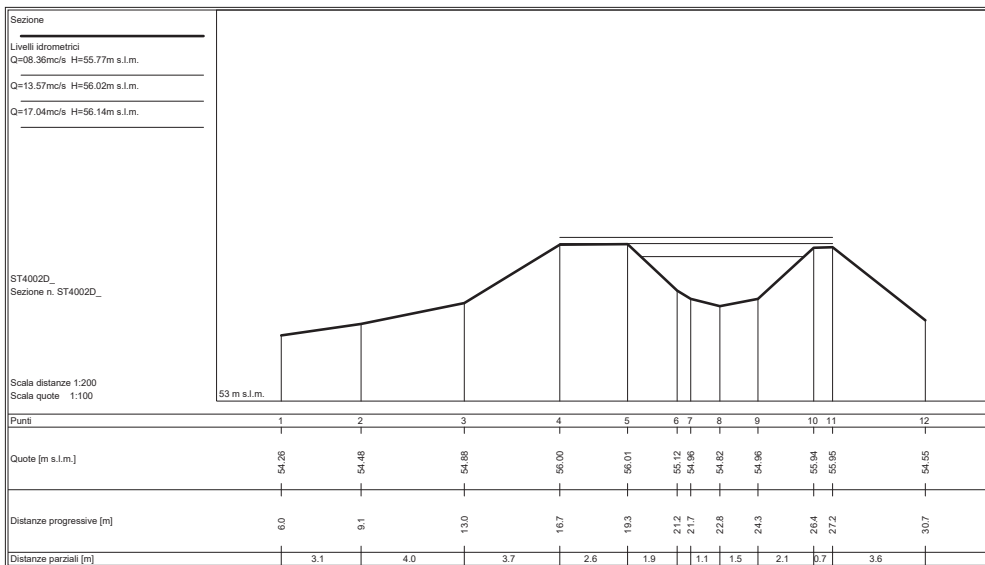
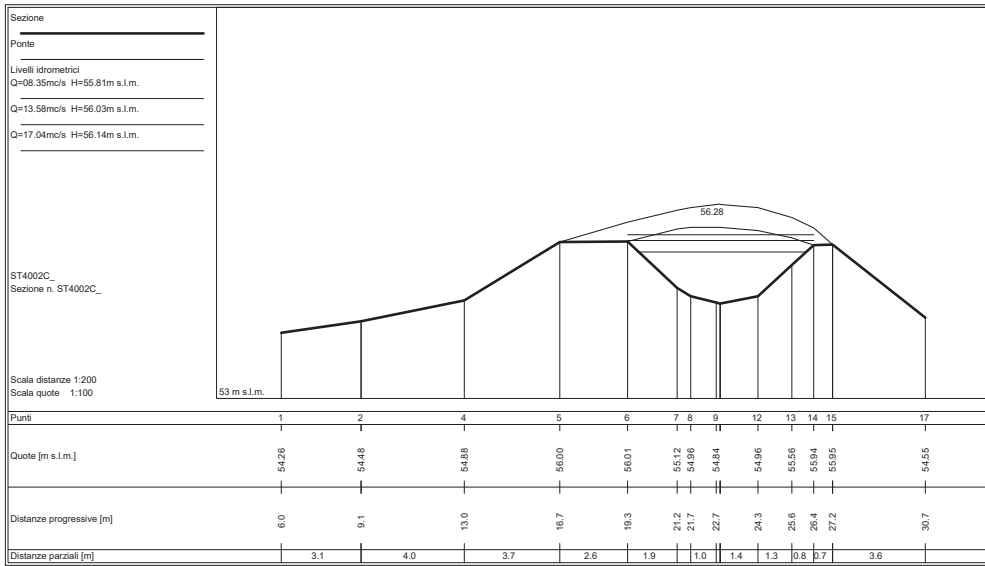

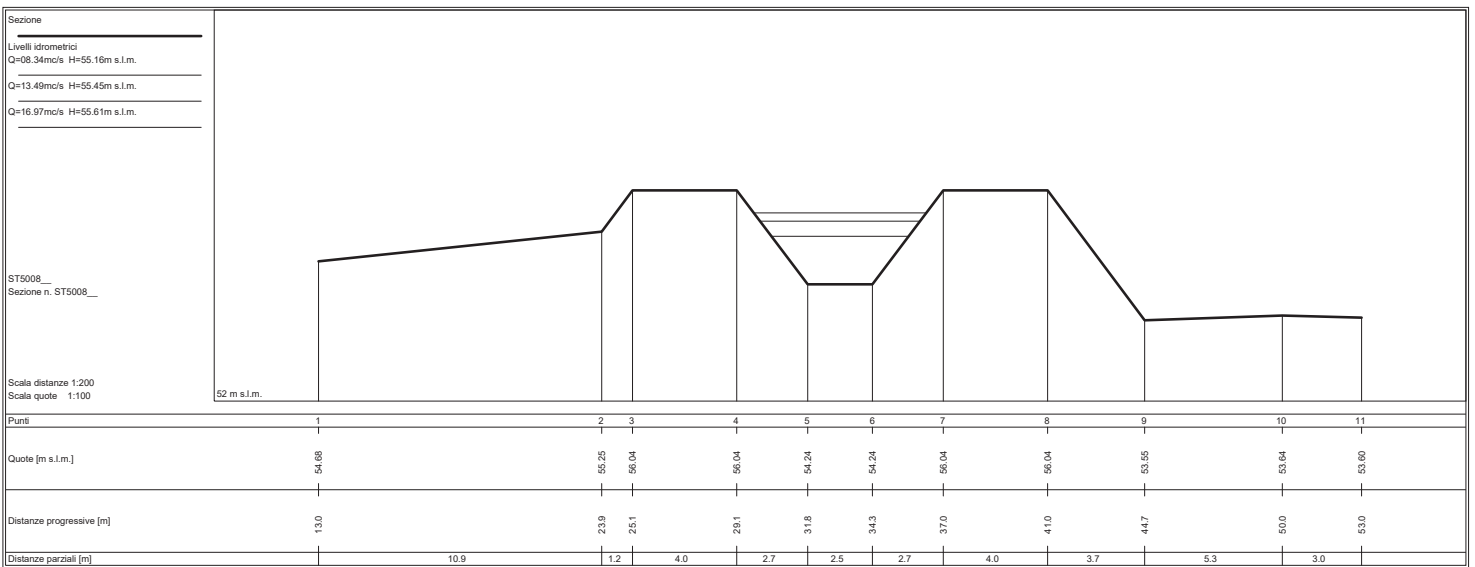
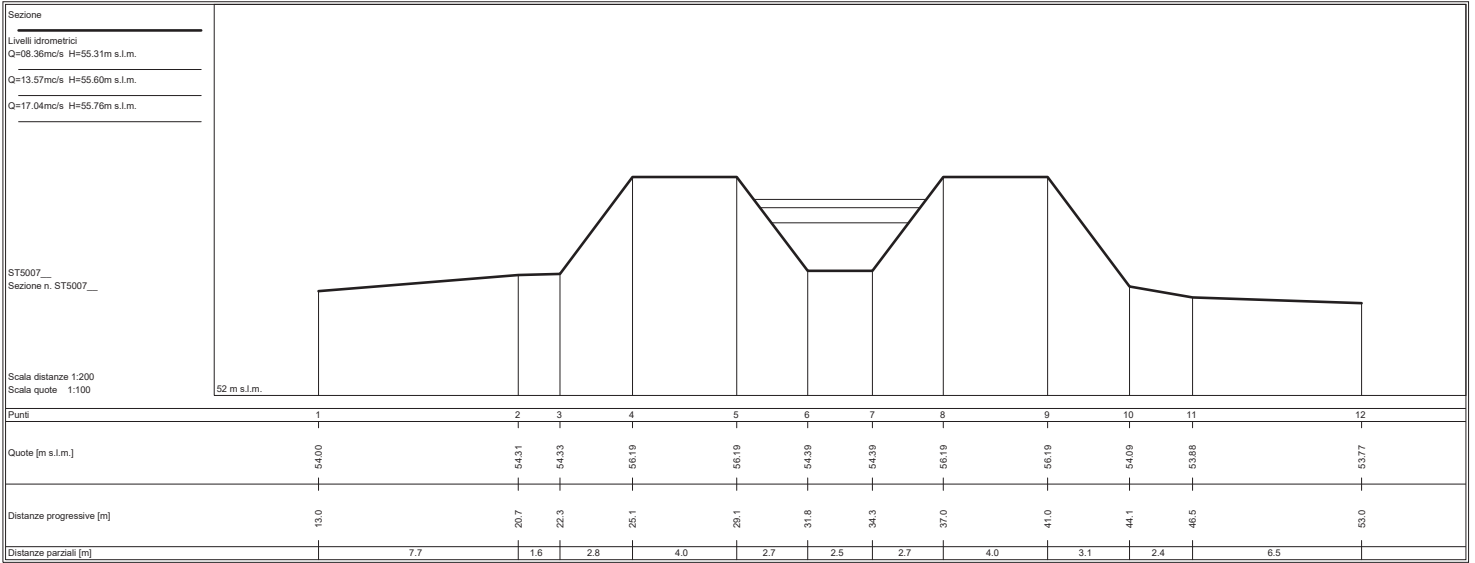

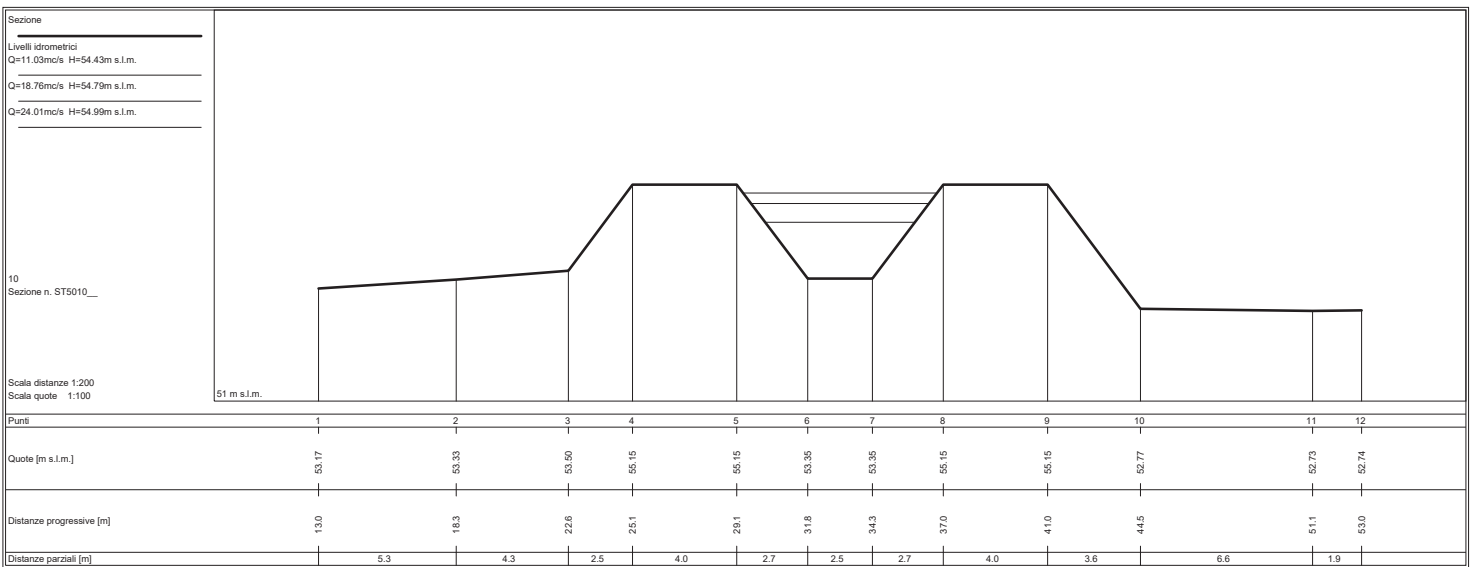
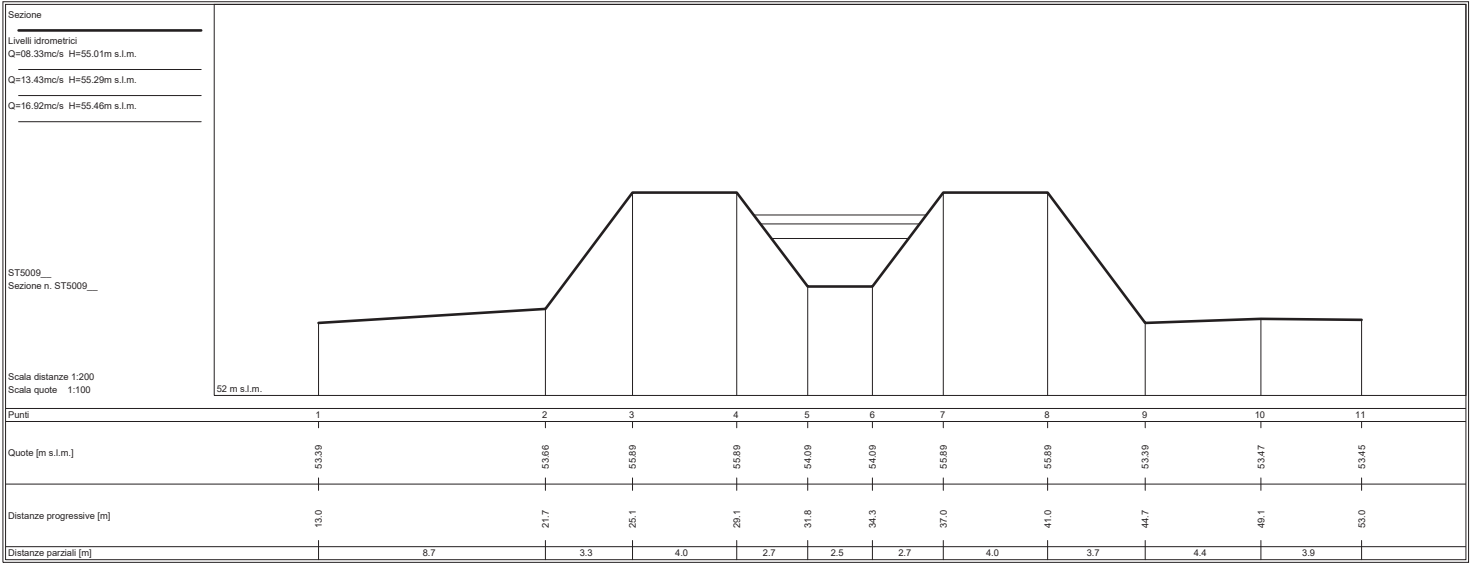



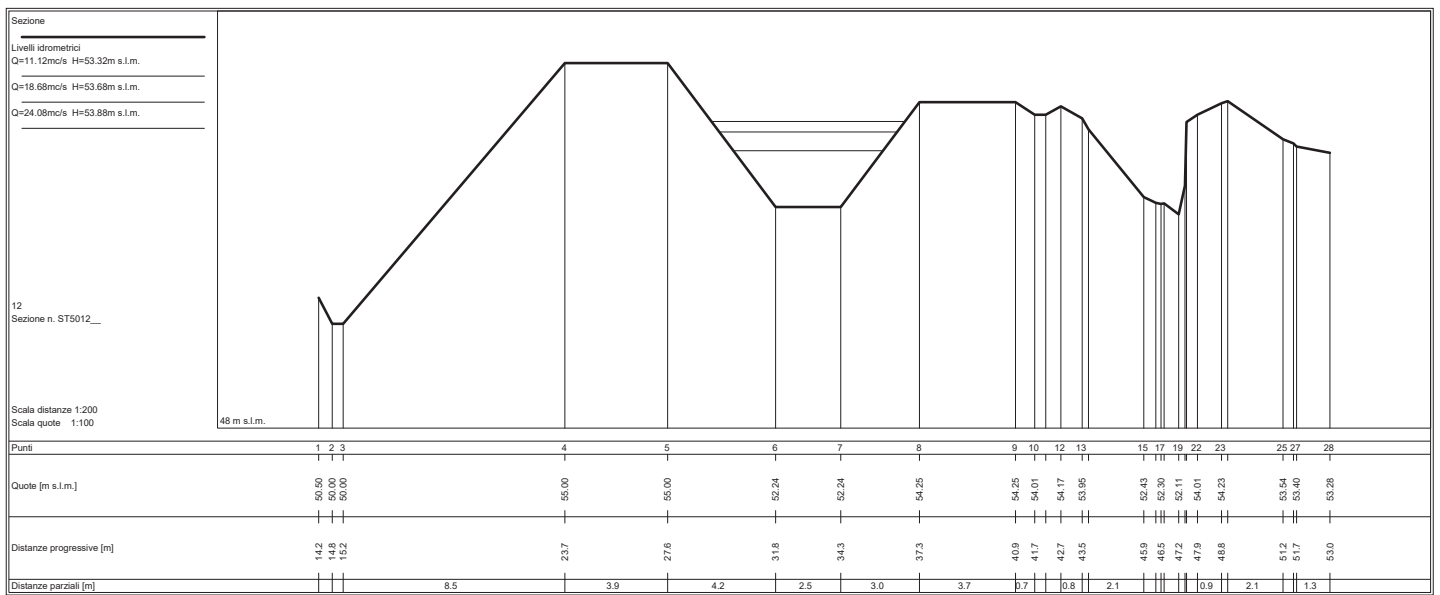
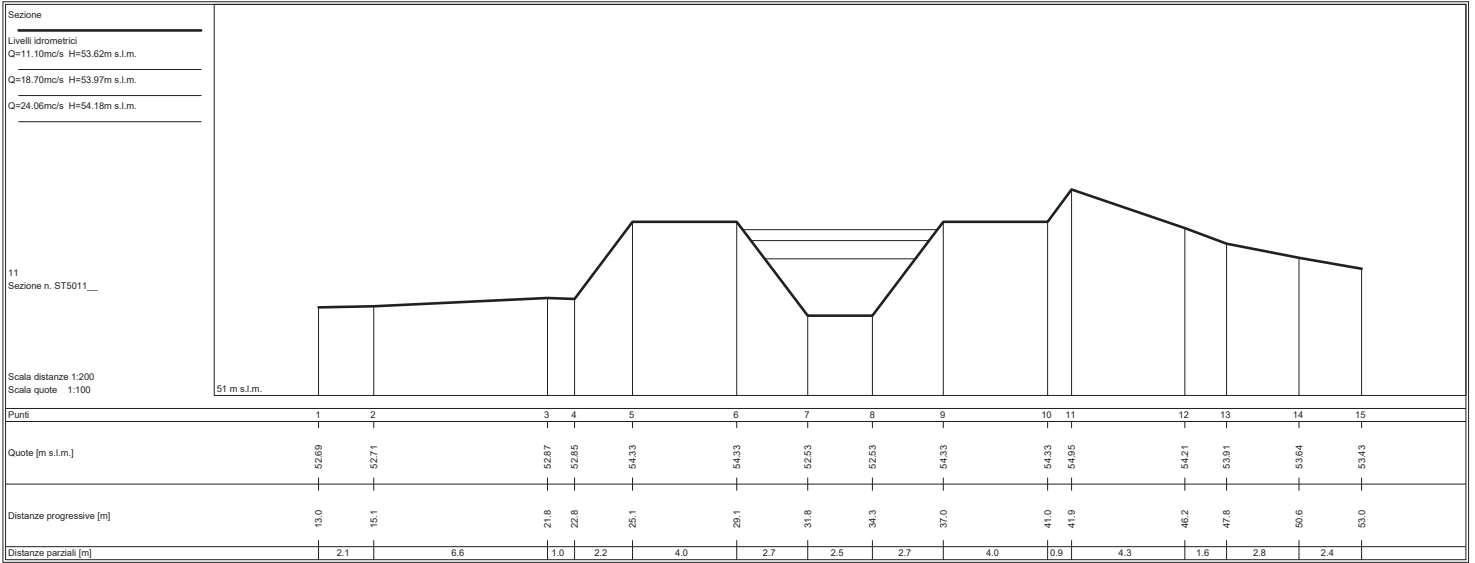

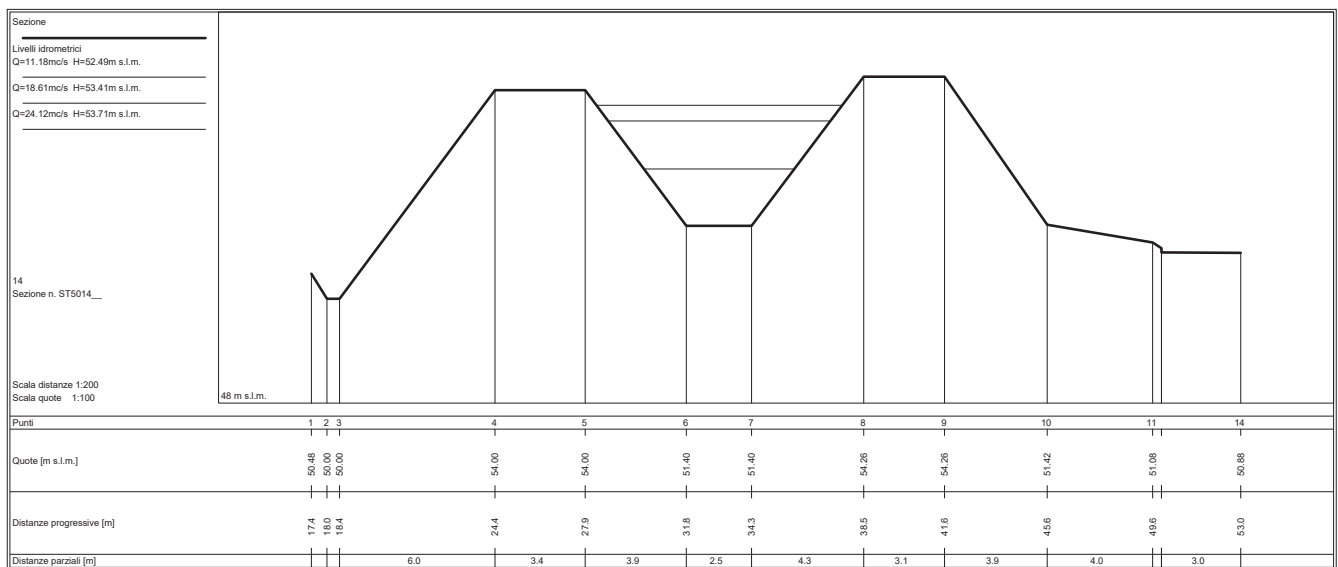
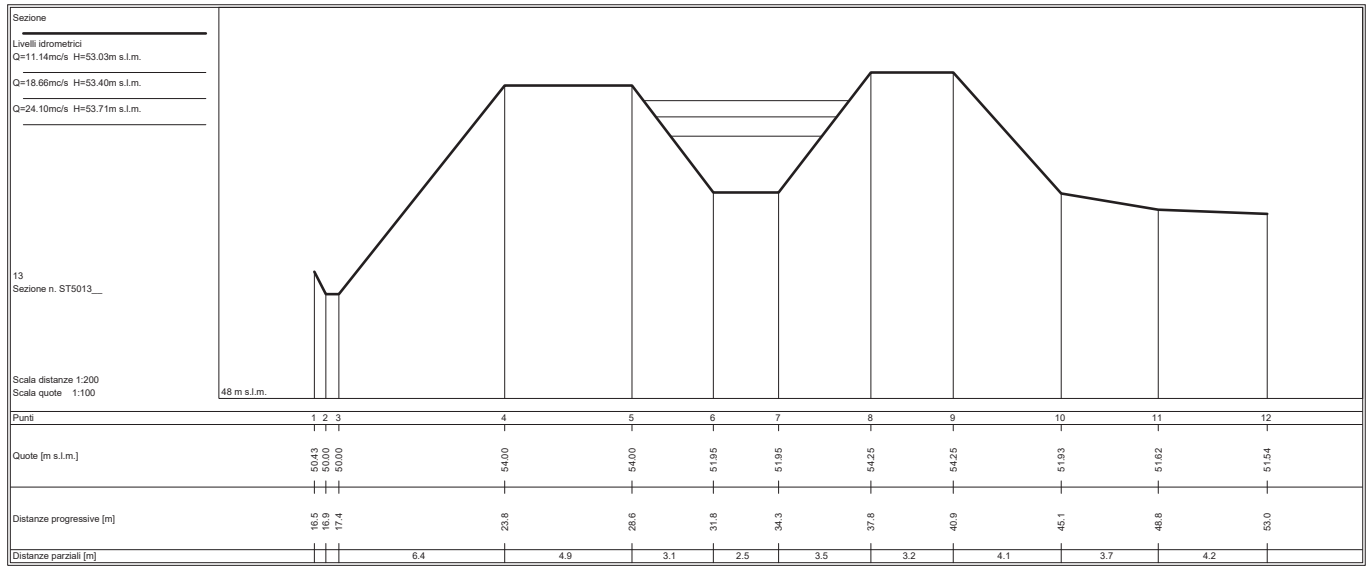

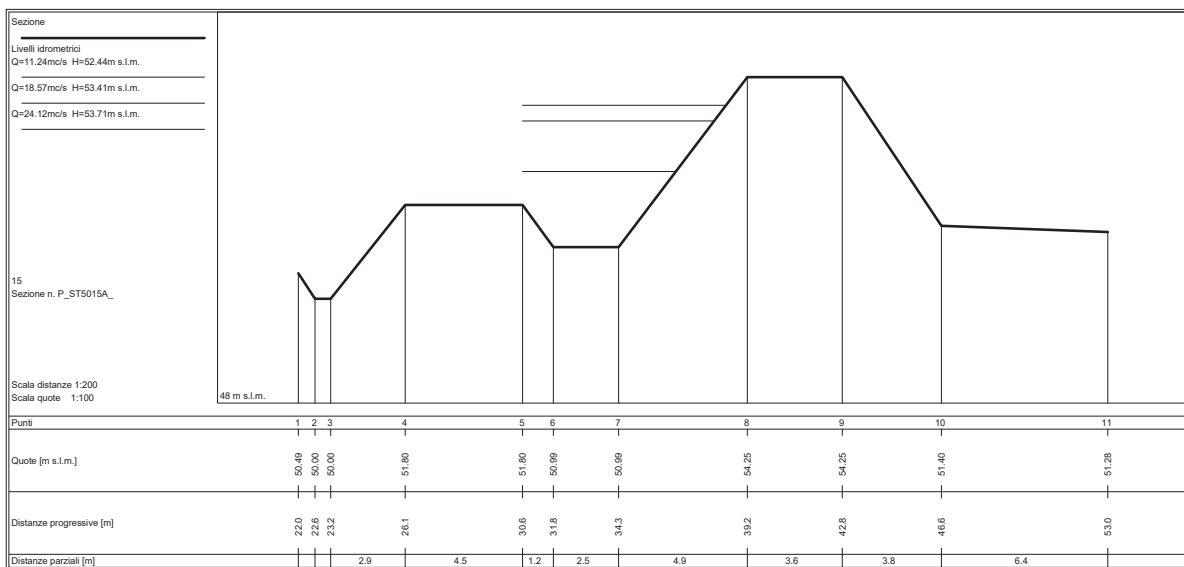
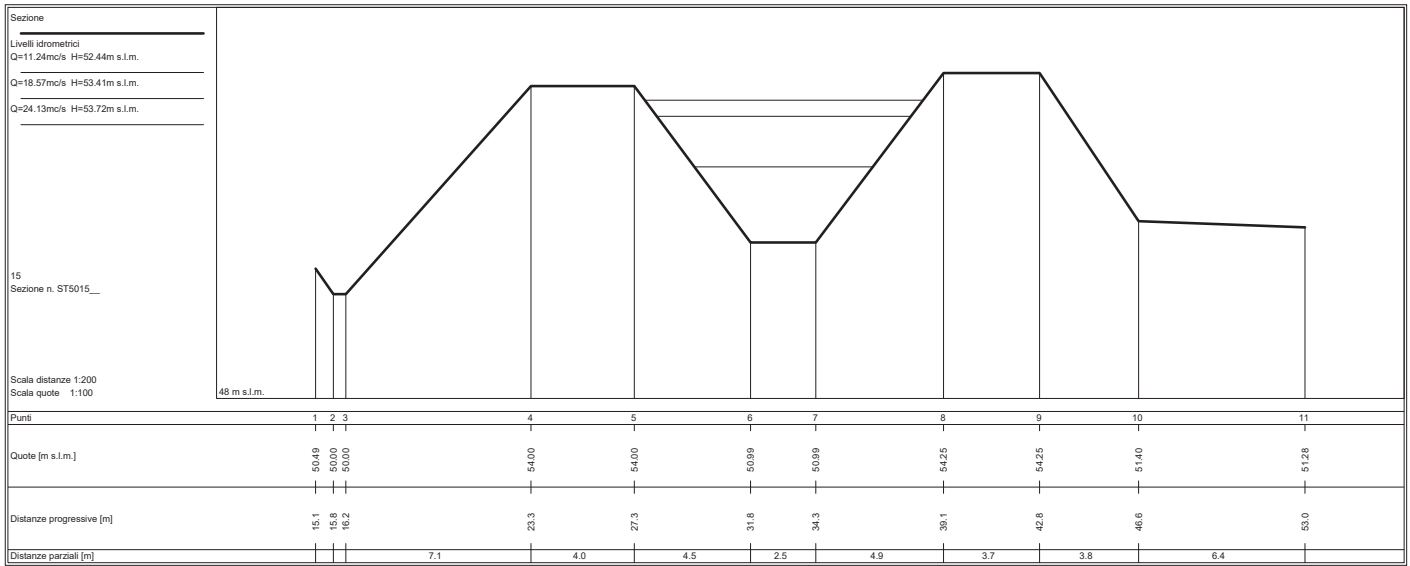

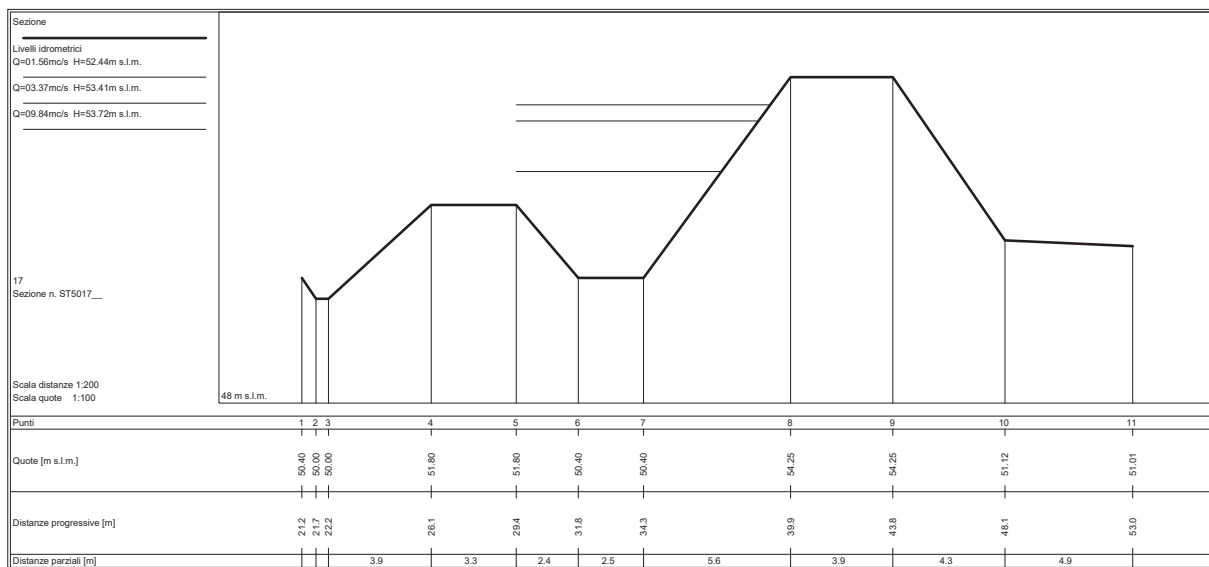
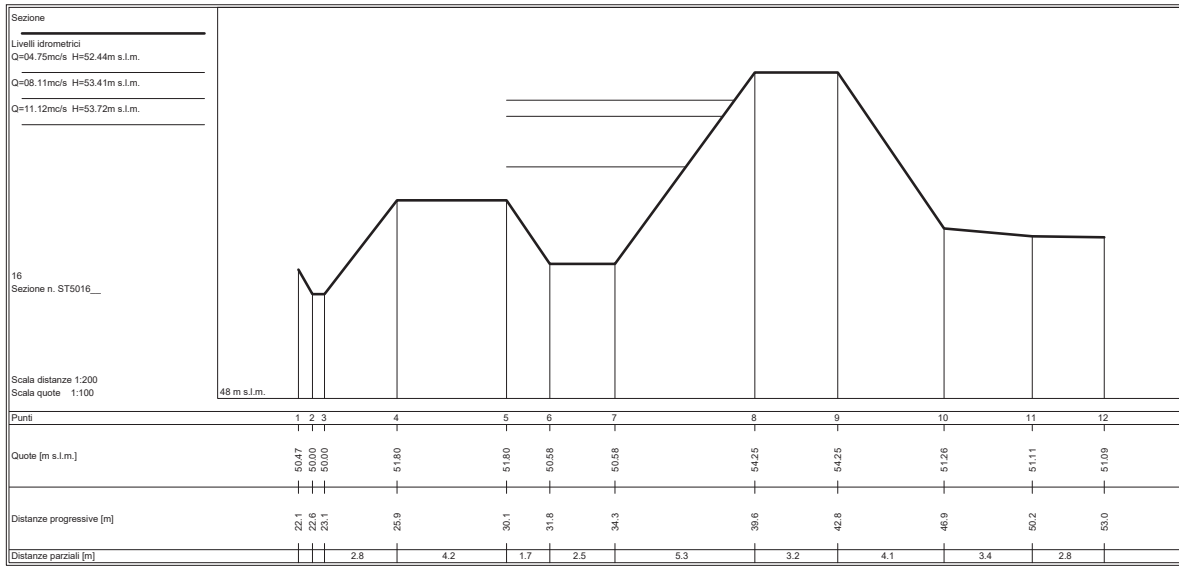

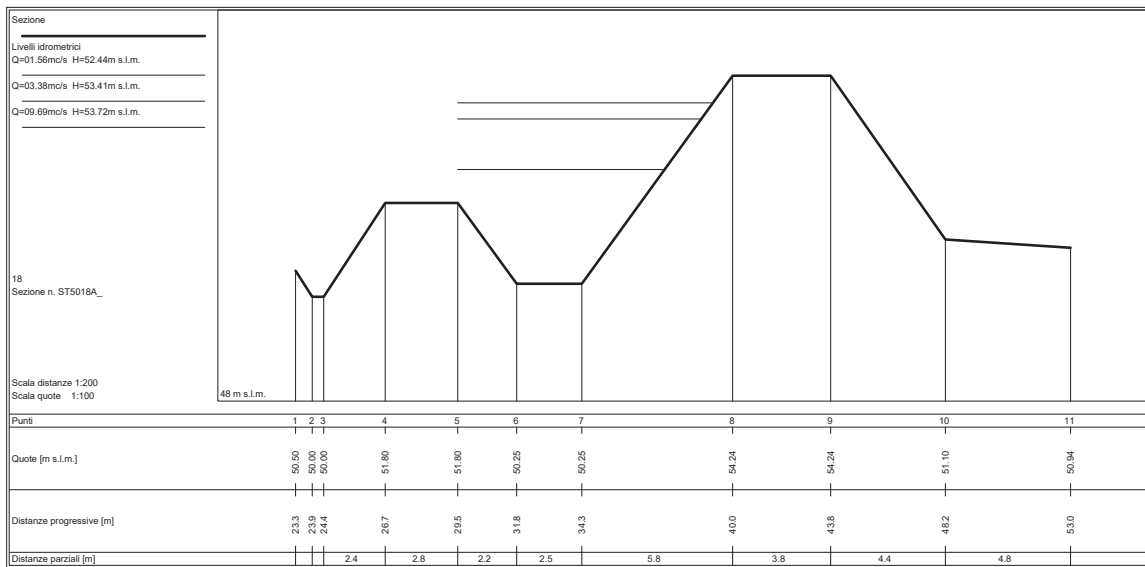
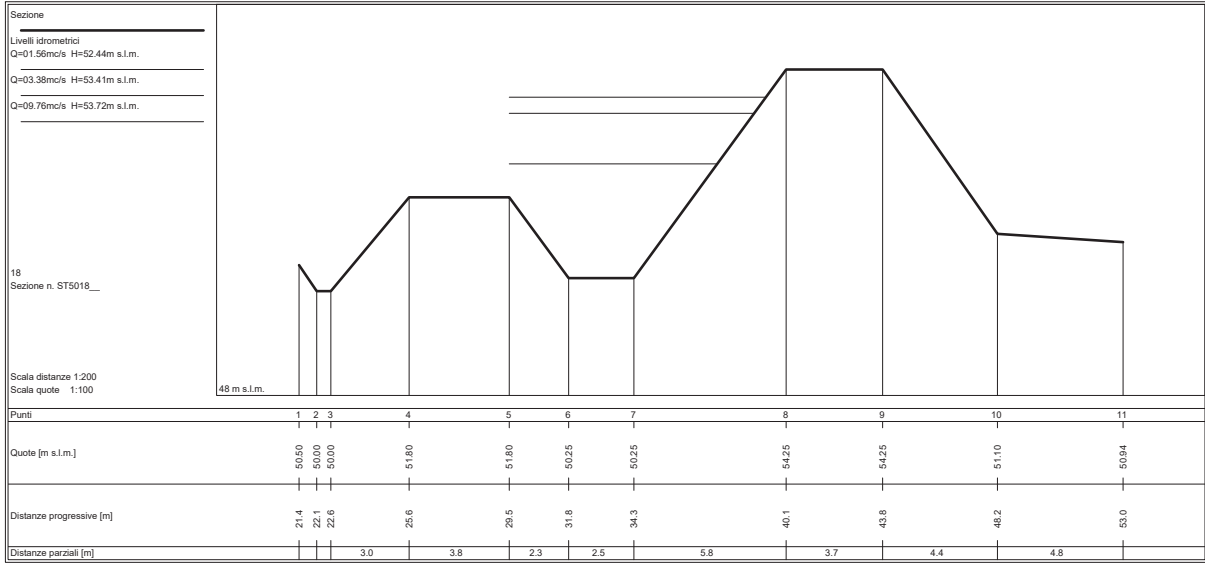

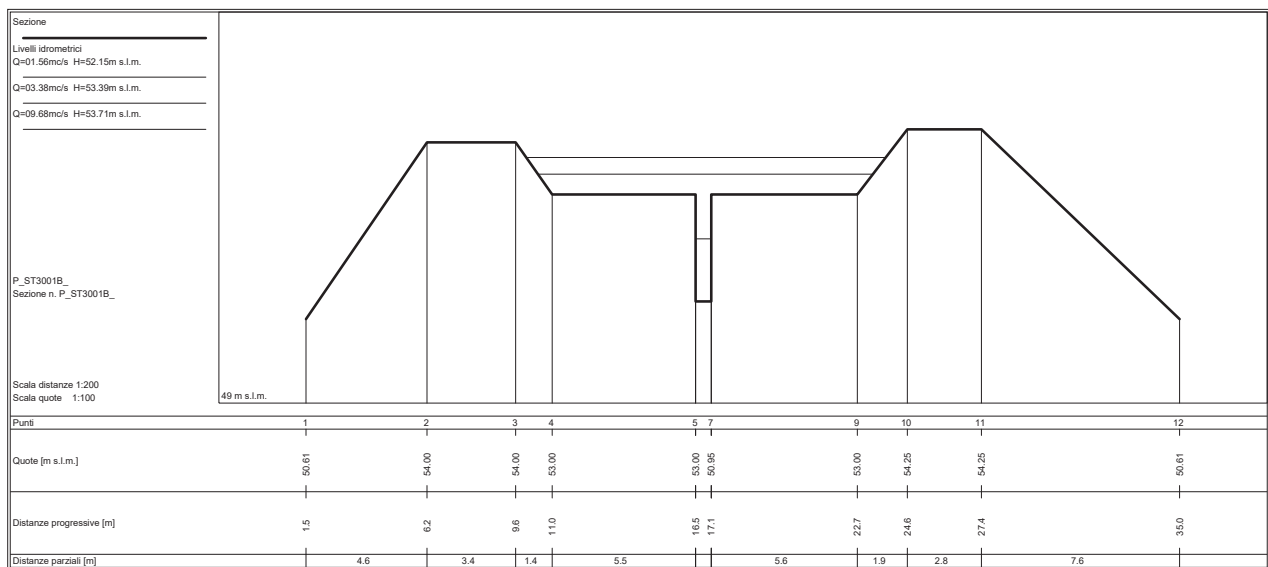
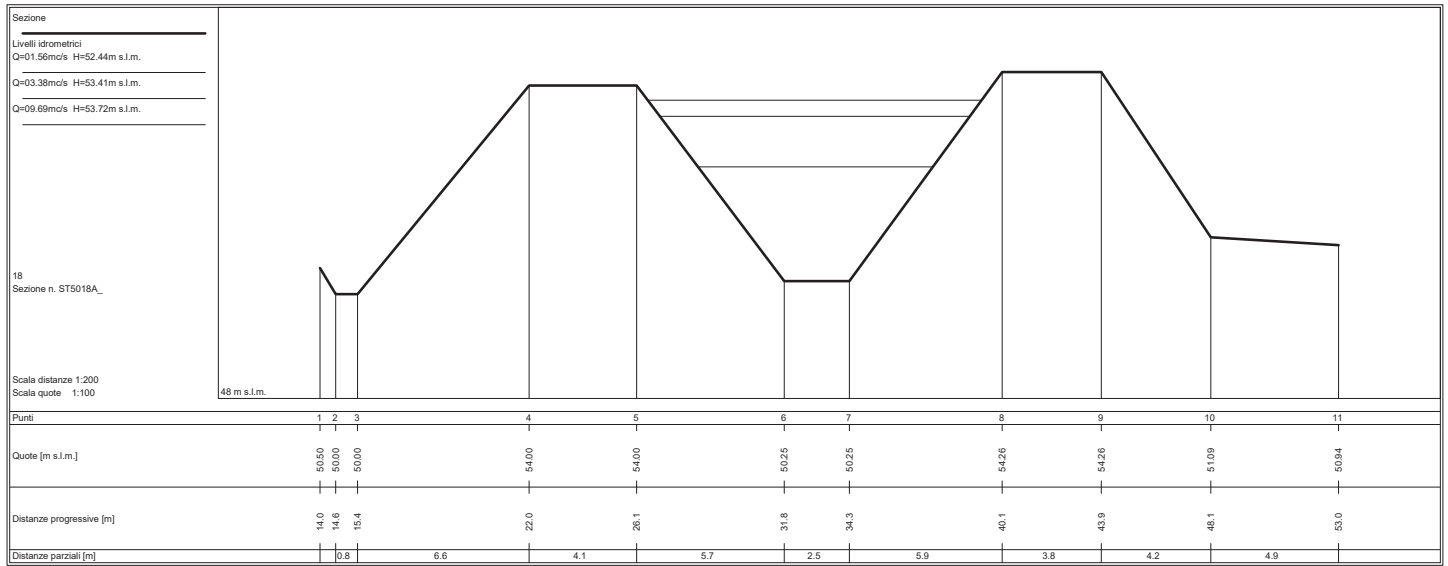

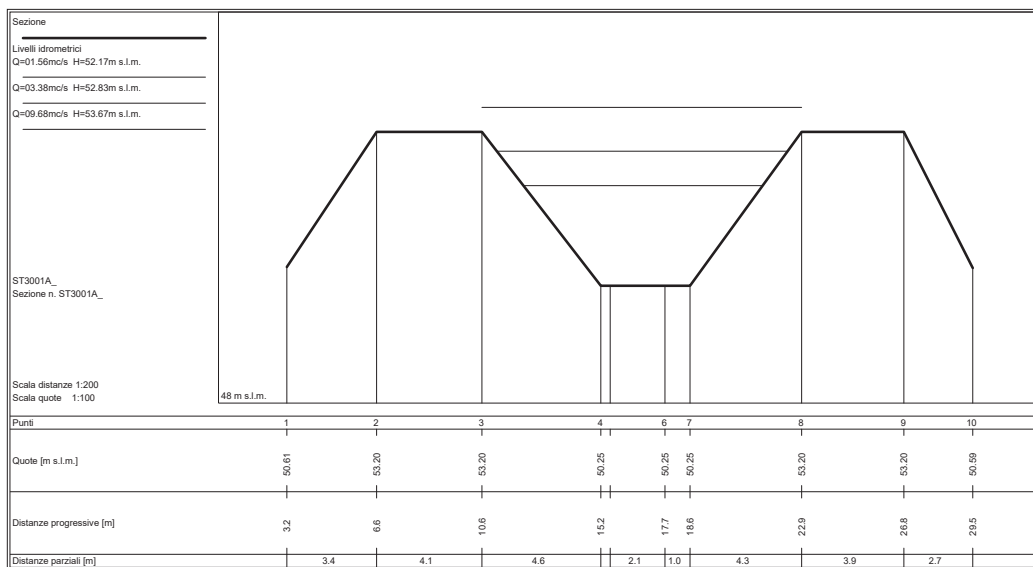
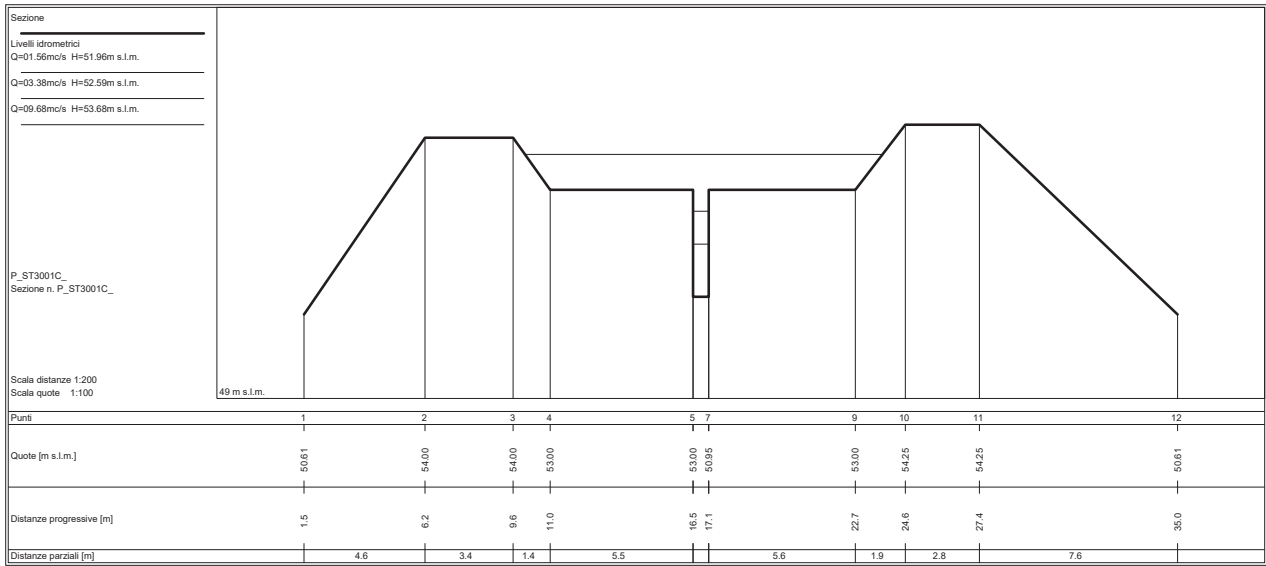

SEZIONI FLUVIALI  
FOSSO STREGALE - TRATTO 2



